



US00D891130S

(12) **United States Design Patent**
Kanhasamy

(10) **Patent No.:** **US D891,130 S**
(45) **Date of Patent:** **** Jul. 28, 2020**

(54) **SPLIT-BACK CONVERTIBLE SOFA WITH CHAISE**

(71) Applicant: **Abedan Kanhasamy**, Mississauga (CA)

(72) Inventor: **Abedan Kanhasamy**, Mississauga (CA)

(**) Term: **15 Years**

(21) Appl. No.: **29/695,741**

(22) Filed: **Jun. 21, 2019**

(30) **Foreign Application Priority Data**

Jun. 10, 2019 (CA) 187958

(51) **LOC (12) Cl.** **06-01**

(52) **U.S. Cl.**
USPC **D6/335; D6/381**

(58) **Field of Classification Search**
USPC D6/334, 335, 374, 375, 377, 381
CPC A47C 17/00; A47C 17/02; A47C 17/04;
A47C 17/045; A47C 17/13; A47C 17/132; A47C 17/134; A47C 17/16; A47C 17/17; A47C 17/162; A47C 17/18; A47C 17/86

See application file for complete search history.

(56) **References Cited**

U.S. PATENT DOCUMENTS

D446,962 S *	8/2001	Mourgue	D6/335
D498,075 S *	11/2004	Mourgue	D6/335
D635,794 S *	4/2011	Kanhasamy	D6/381
D675,460 S *	2/2013	Kanhasamy	D6/381
D719,755 S *	12/2014	Kanhasamy	D6/381
D799,222 S *	10/2017	Pathiratne	D6/335
D804,834 S *	12/2017	Kanhasamy	D6/335
D829,452 S *	10/2018	Kanhasamy	D6/335
D836,926 S *	1/2019	Kanhasamy	D6/335
D836,927 S *	1/2019	Kanhasamy	D6/335
2011/0016626 A1 *	1/2011	Kanhasamy	A47C 17/16 5/37.1
2012/0297535 A1 *	11/2012	Kanhasamy	A47C 20/043 5/12.1
2019/0029434 A1 *	1/2019	Platzer	A47C 17/162

OTHER PUBLICATIONS

Irvine Black Mesh Convertible Sofa, 8 Black Convertible Sleeper Sofas for Your Living Room, cutefurniture.com, Nov. 19, 2015, site visited Mar. 4, 2020, available online at <https://www.cute-furniture.com/living-room/8-black-convertible-sleeper-sofas-for-your-living-room/> (Year: 2015).*

* cited by examiner

Primary Examiner — Cathron C Brooks
(74) *Attorney, Agent, or Firm* — Harness, Dickey & Pierce, P.L.C.

(57) **CLAIM**

The ornamental design for a split-back convertible sofa with chaise, as shown and described.

DESCRIPTION

FIG. 1 is a front view of the split-back convertible sofa with chaise in a first position;
FIG. 2 is a front, right side, perspective view of the split-back convertible sofa with chaise in the first position;
FIG. 3 is a front, right side, perspective view of the split-back convertible sofa with chaise in a second position;
FIG. 4 is a front, right side, perspective view of the split-back convertible sofa with chaise in a third position;
FIG. 5 is a front, right side, perspective view of the split-back convertible sofa with chaise in a fourth position;
FIG. 6 is a front, right side, perspective view of the split-back convertible sofa with chaise in a fifth position;
FIG. 7 is a right side view of the split-back convertible sofa with chaise in the first position;
FIG. 8 is a left side view of the split-back convertible sofa with chaise in the first position; and,
FIG. 9 is a back, left side, perspective view of the split-back convertible sofa with chaise in the first position.

1 Claim, 9 Drawing Sheets

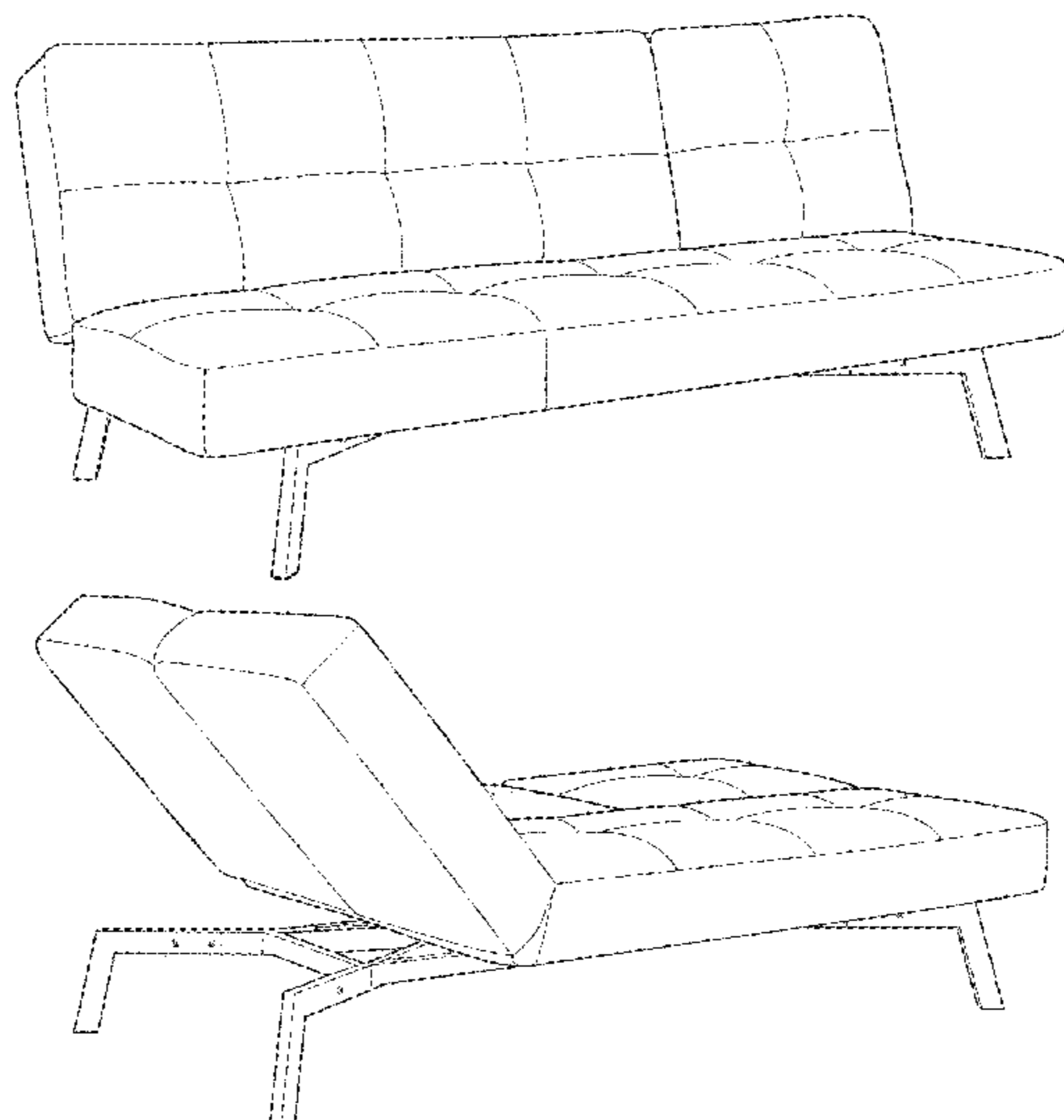

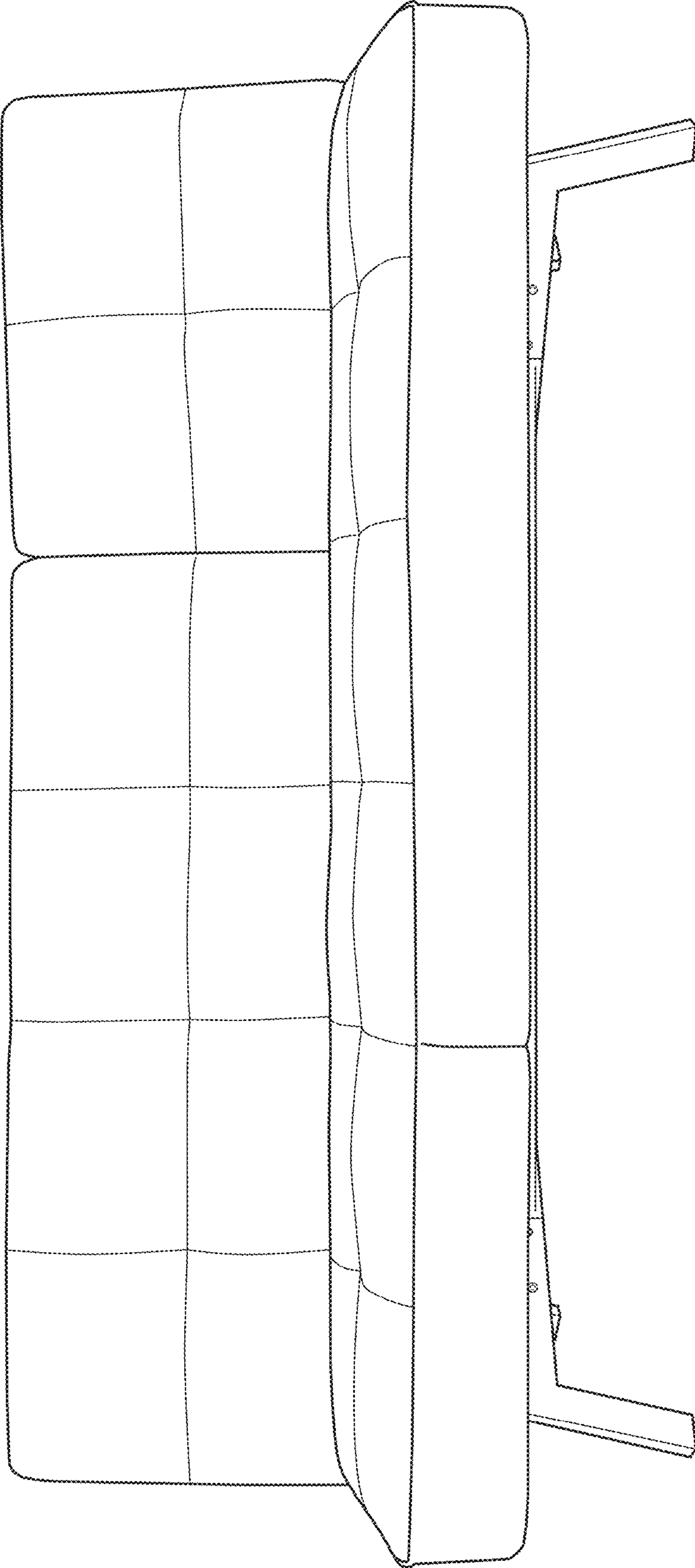

FIG. 1

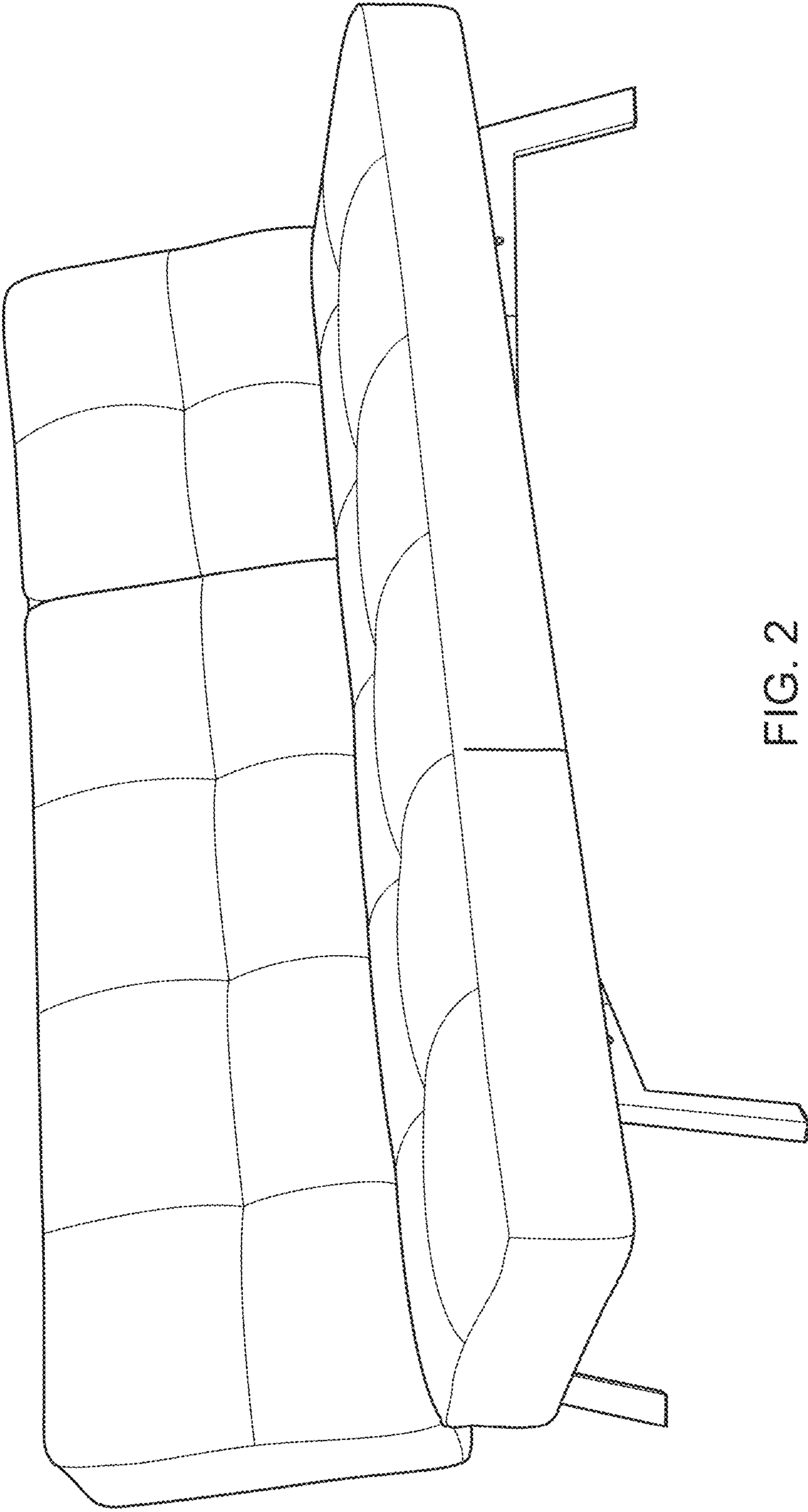

FIG. 2

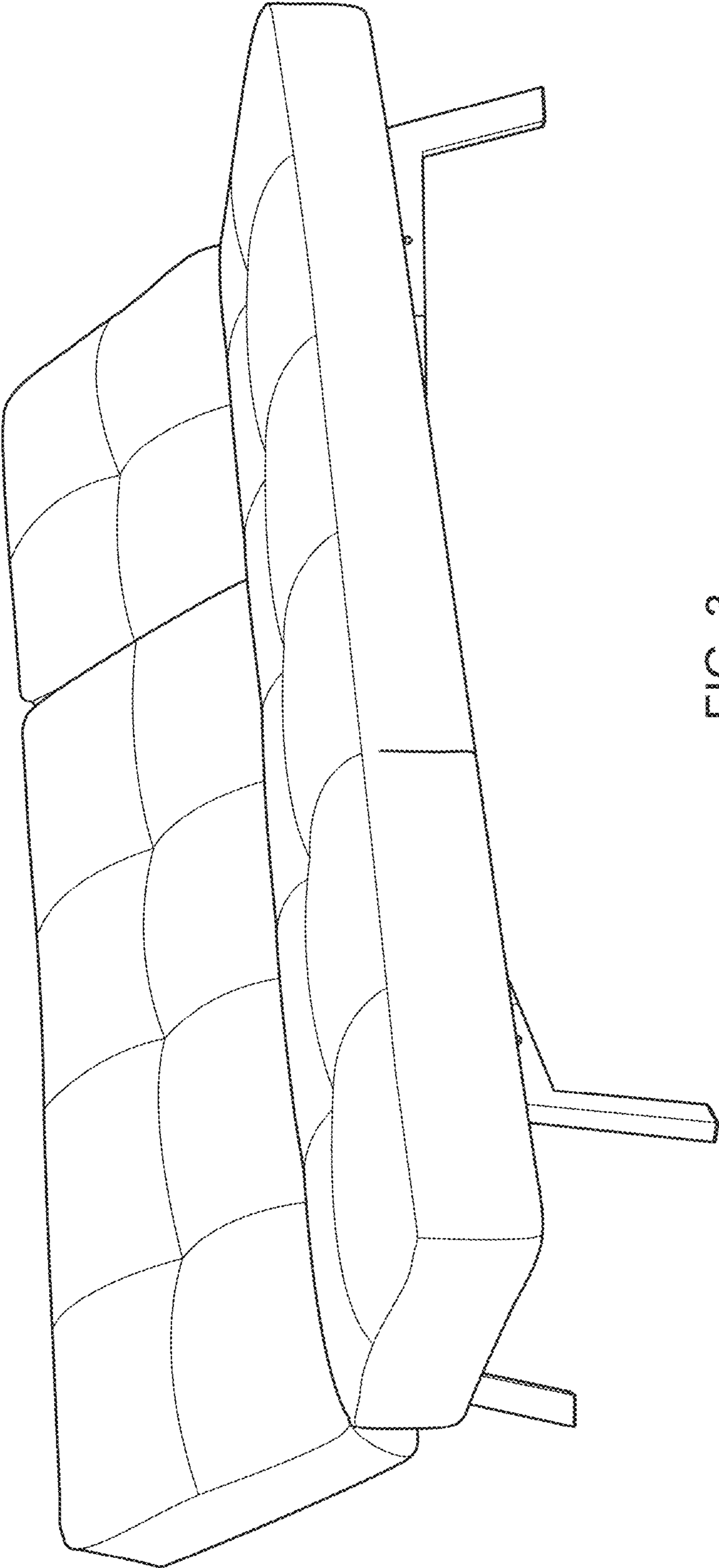

FIG. 3

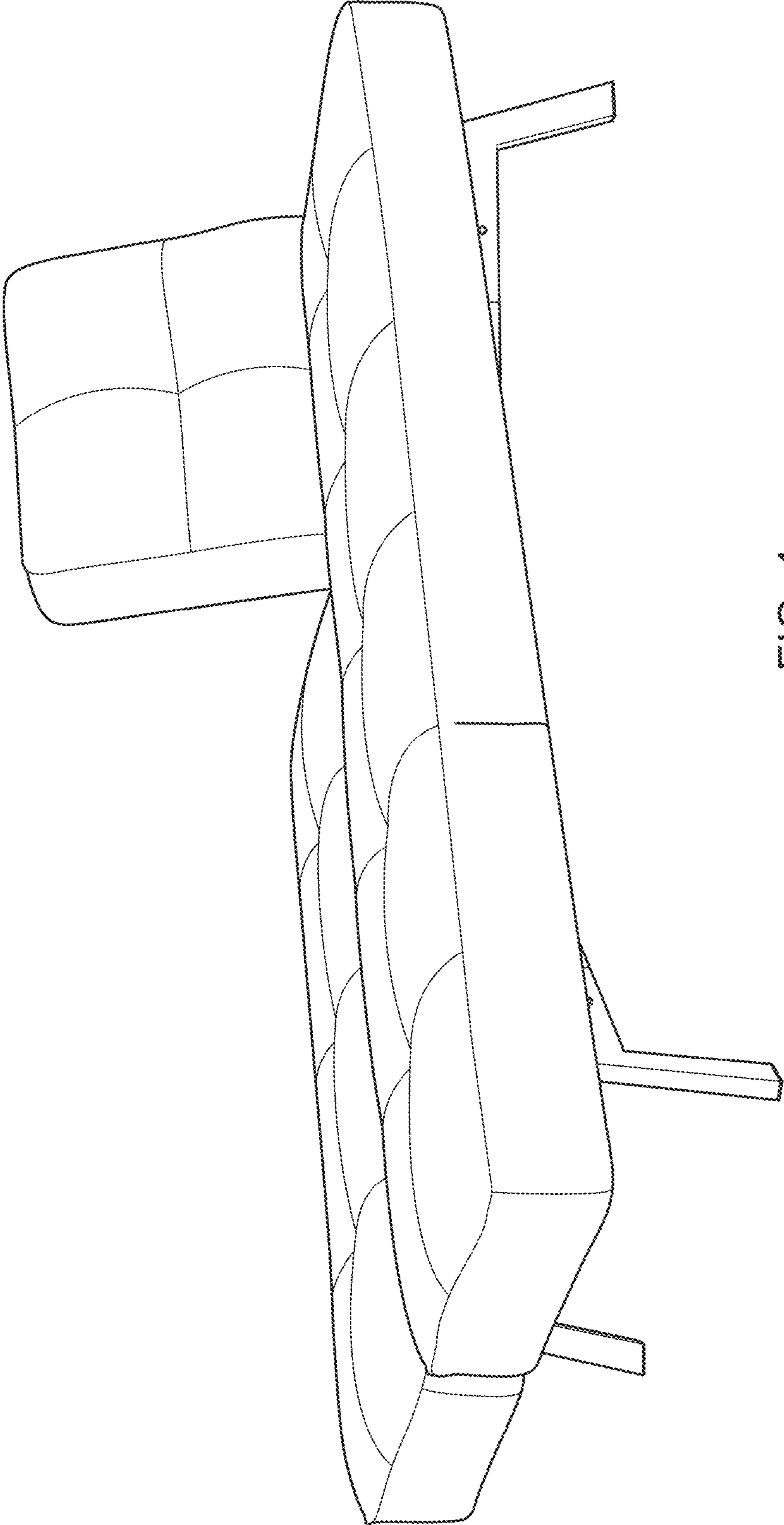

FIG. 4

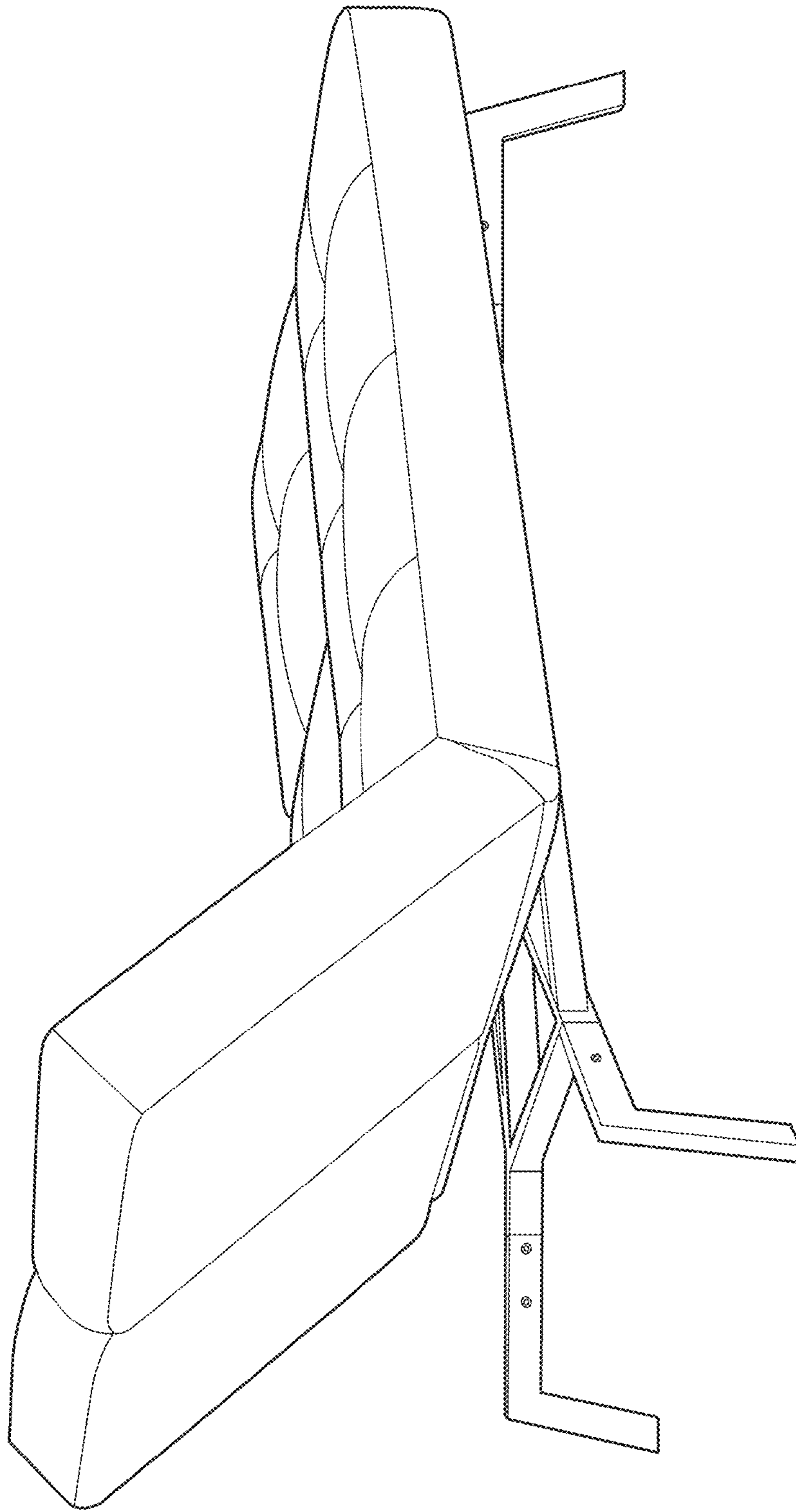

FIG. 5



FIG. 6

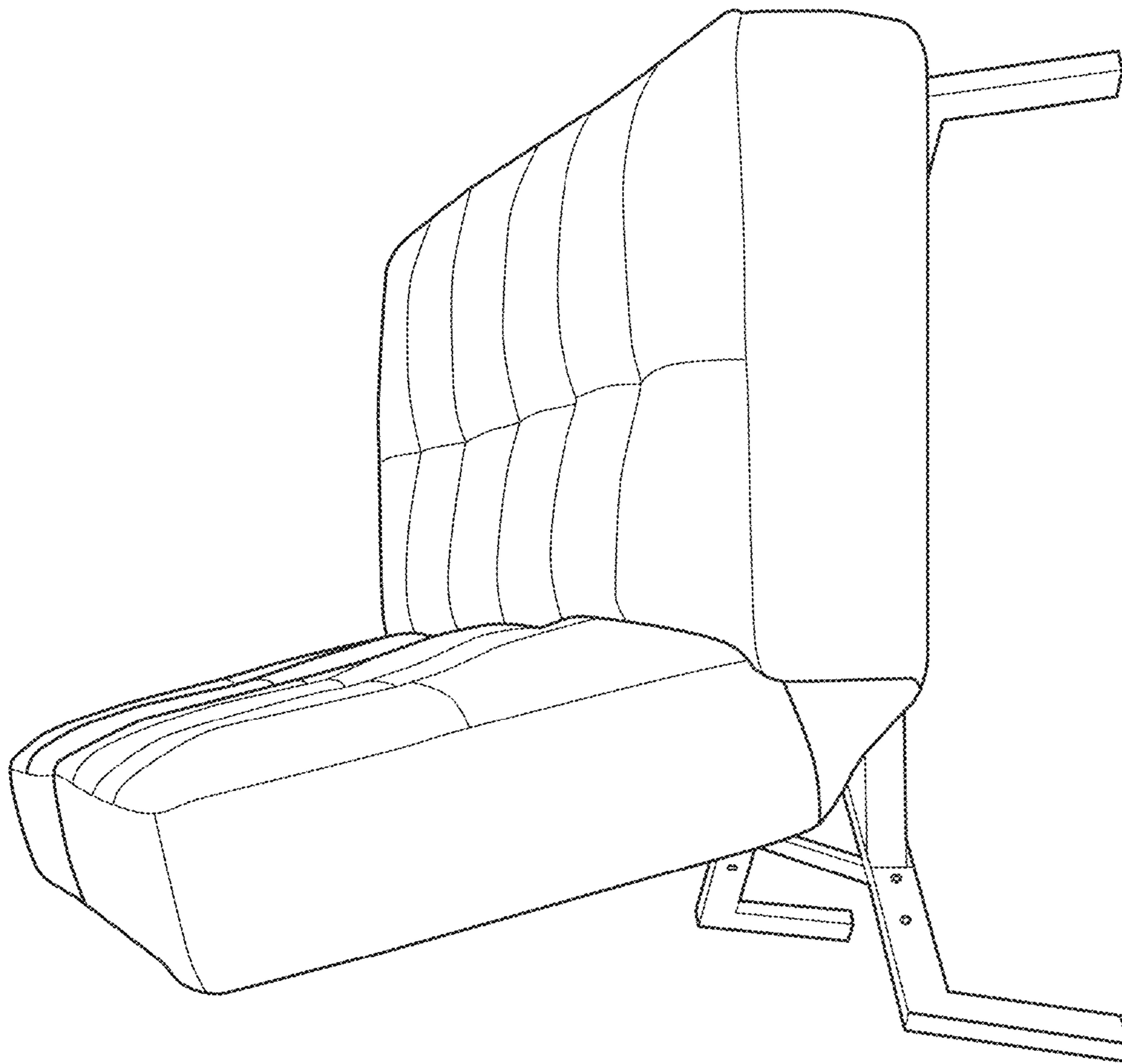

FIG. 7

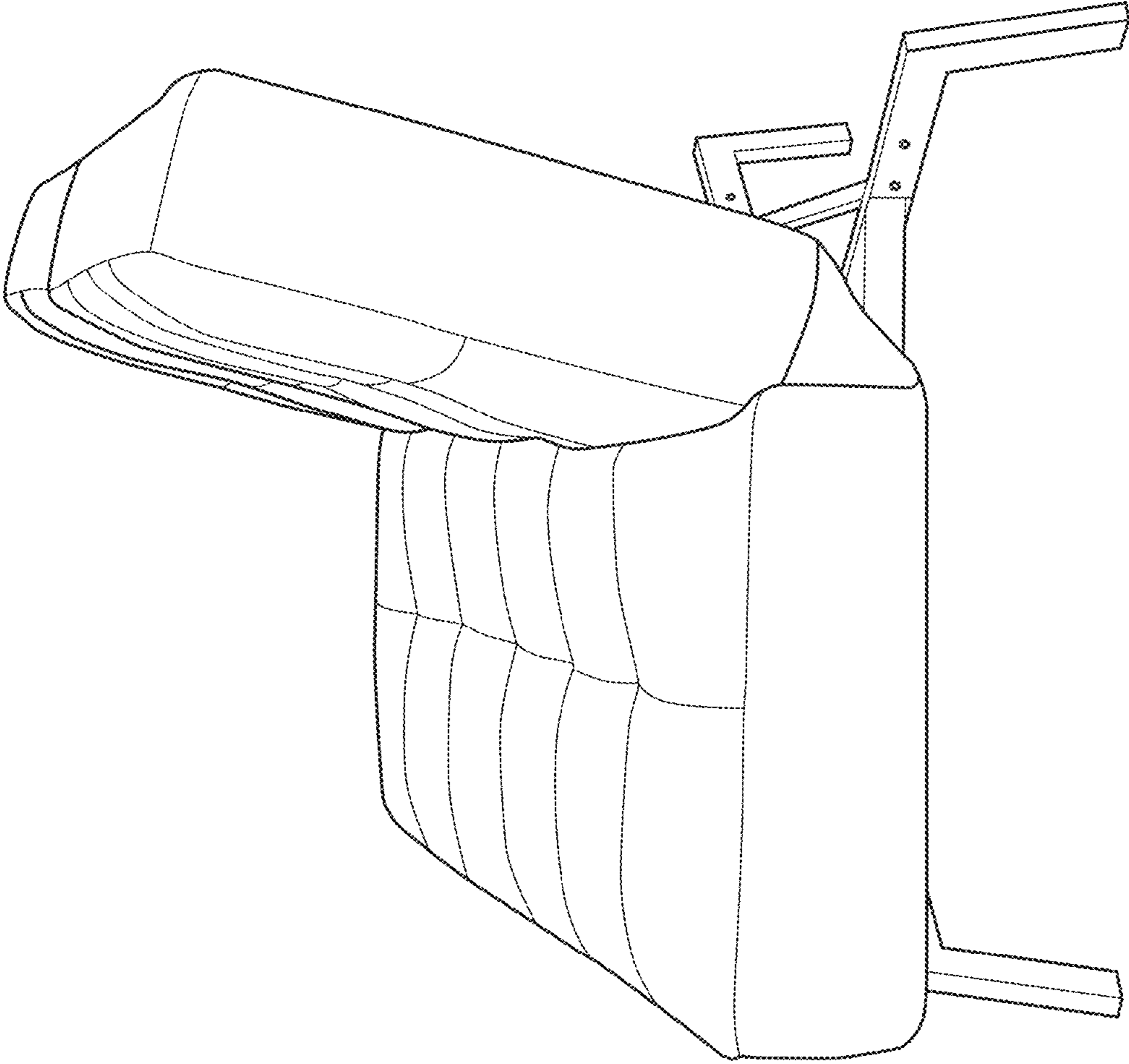

FIG. 8

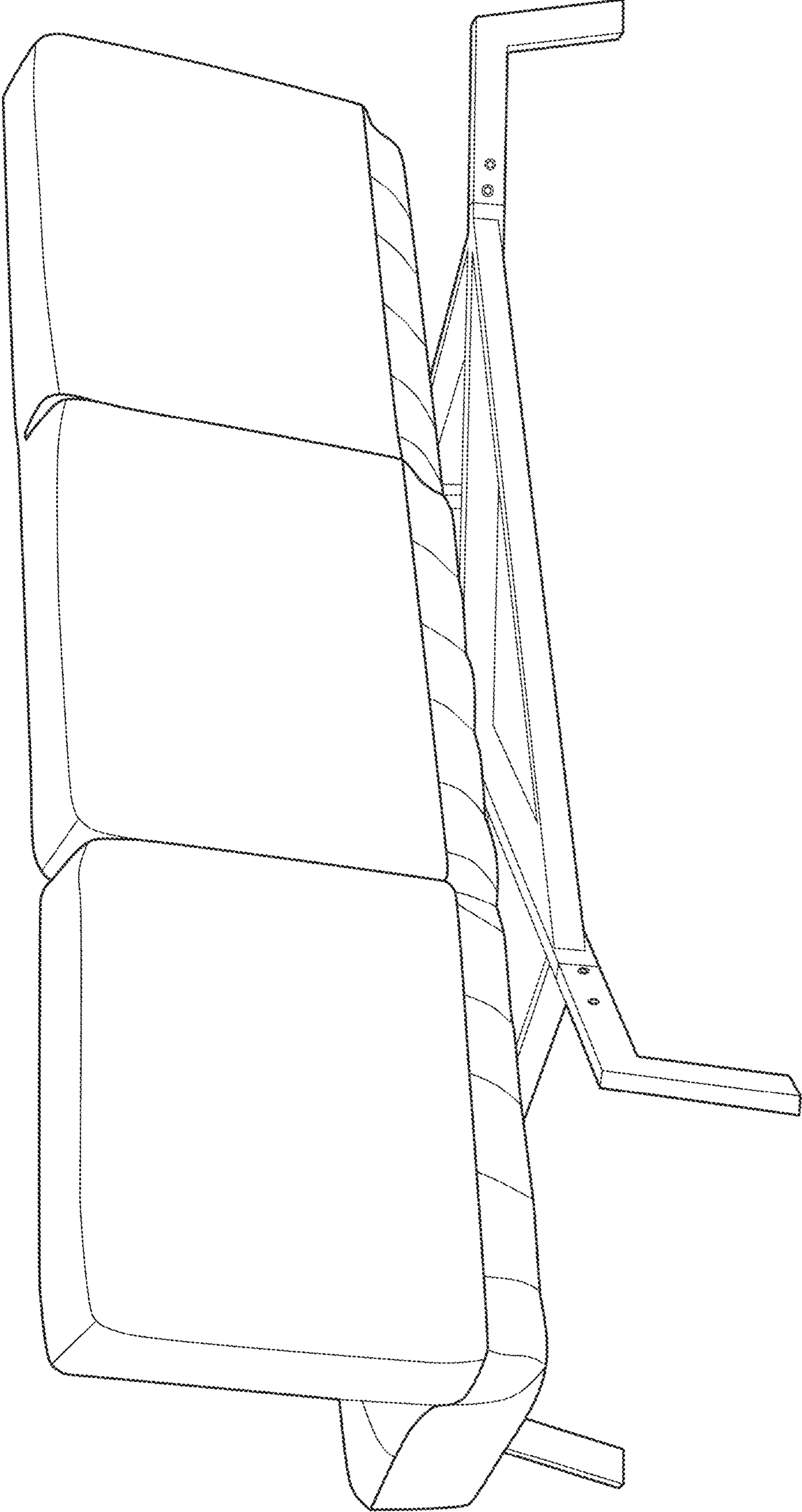

FIG. 9