



US00D891101S

(12) **United States Design Patent** (10) **Patent No.:** **US D891,101 S**  
Lv (45) **Date of Patent:** **\*\* Jul. 28, 2020**

(54) **WALLET**

(71) Applicant: **Guangzhou Zhixun Xingyi Information Technology Co., Ltd.**, Guangzhou (CN)

(72) Inventor: **Chaoneng Lv**, Guangzhou (CN)

(\*\*) Term: **15 Years**

(21) Appl. No.: **29/695,254**

(22) Filed: **Jun. 18, 2019**

(51) **LOC (12) Cl.** ..... **03-01**

(52) **U.S. Cl.**  
USPC ..... **D3/249**

(58) **Field of Classification Search**  
USPC ..... D3/247, 249–253  
CPC ..... A45C 1/06; A45C 3/08  
See application file for complete search history.

(56) **References Cited**

**U.S. PATENT DOCUMENTS**

D93,701 S \* 10/1934 Buxton ..... D3/253  
D372,359 S \* 8/1996 Tytula ..... D3/250  
D832,832 S \* 11/2018 Lamb ..... D14/250

**OTHER PUBLICATIONS**

YouTube Video entitled “6 Simple & Minimalist Wallets You must Try” Wally Junior smartphone wallet uploaded on Apr. 10, 2017 by Gadget Inspiration. Retrieved from the Internet: <https://youtu.be/u6YWDHKKv1o> (Year: 2017) (Year: 2017).\*

Minimalist Slim Bifold Front Pocket Wallet With Money Clip for Men, Effective RFID Blocking & Smart Design, [https://www.amazon.ca/dp/B07RXB3NJ8?ref=myi\\_title\\_dp](https://www.amazon.ca/dp/B07RXB3NJ8?ref=myi_title_dp).

Minimalist Slim Bifold Front Pocket Wallet With Money Clip for Men, Effective RFID Blocking & Smart Design, [https://www.amazon.com/gp/product/B07MTBG1Y4/ref=ag\\_xx\\_cont\\_xx](https://www.amazon.com/gp/product/B07MTBG1Y4/ref=ag_xx_cont_xx).

Men’s With Money Clip ID Card Holder Minimalist Slim Bifold RFID Blocking Wallet, <https://www.ebay.co.uk/itm/173888125705>.

\* cited by examiner

*Primary Examiner* — Holly H Baynham

(74) *Attorney, Agent, or Firm* — KA Filing LLC; Wayne V. Harper; Cynthia Flanigan

(57) **CLAIM**

I claim the ornamental design for a wallet, as shown and described.

**DESCRIPTION**

FIG. 1 is a Perspective view of a wallet showing my new design;

FIG. 2 is a Front view of the wallet as shown in FIG. 1;

FIG. 3 is a Back view of the wallet as shown in FIG. 1;

FIG. 4 is a Left-side view of the wallet as shown in FIG. 1;

FIG. 5 is a Right-side view of the wallet as shown in FIG. 1;

FIG. 6 is a Top view of the wallet as shown in FIG. 1; and,

FIG. 7 is a Bottom view of the wallet as shown in FIG. 1.

The broken lines representing stitching are part of the claimed design.

**1 Claim, 6 Drawing Sheets**

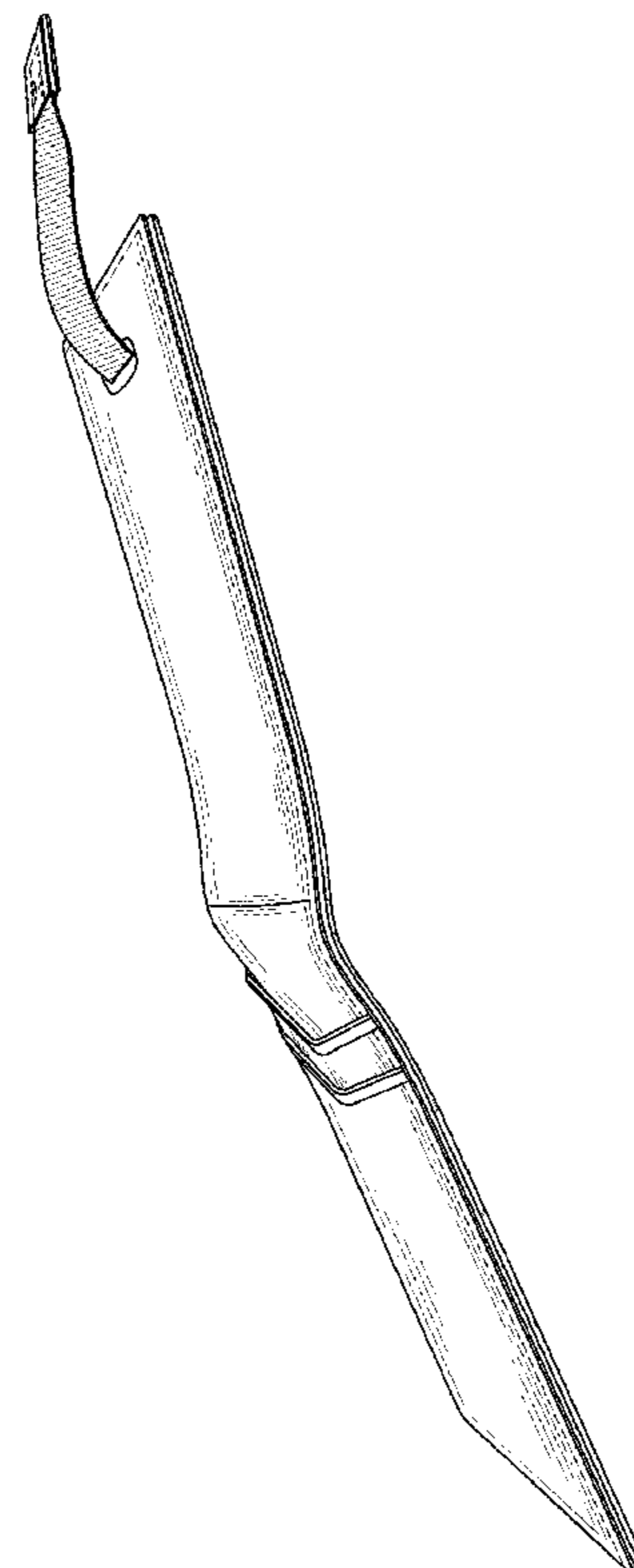

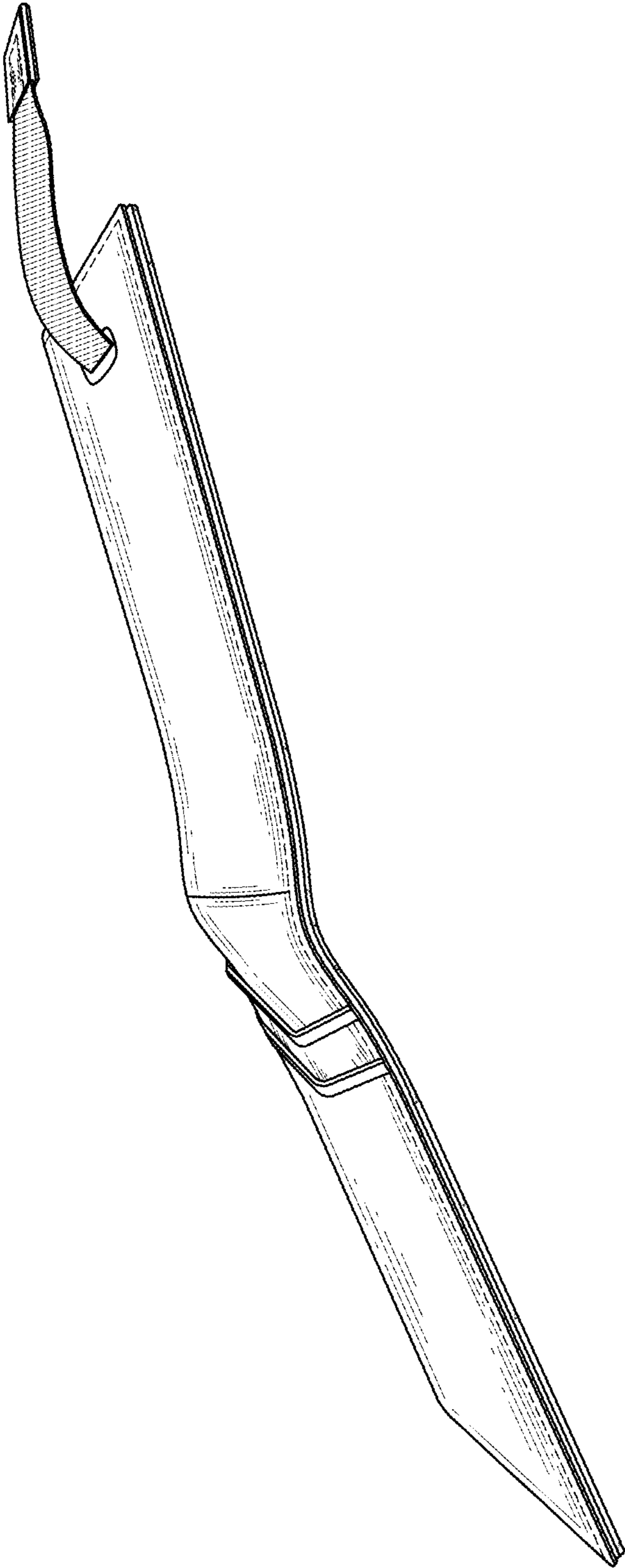

FIG. 1

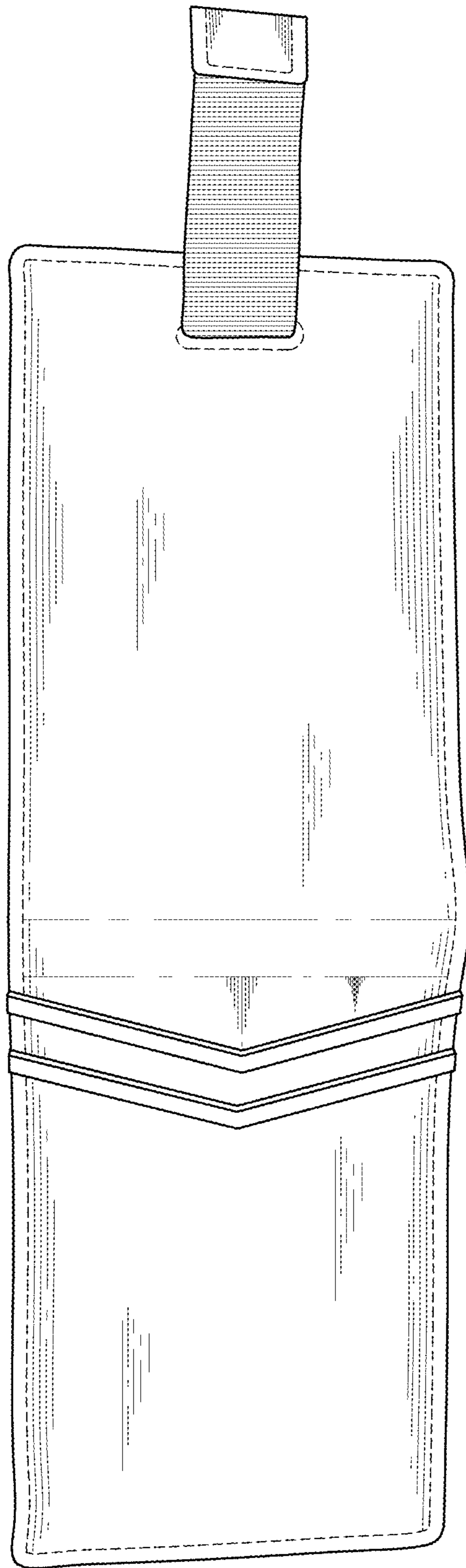

FIG. 2

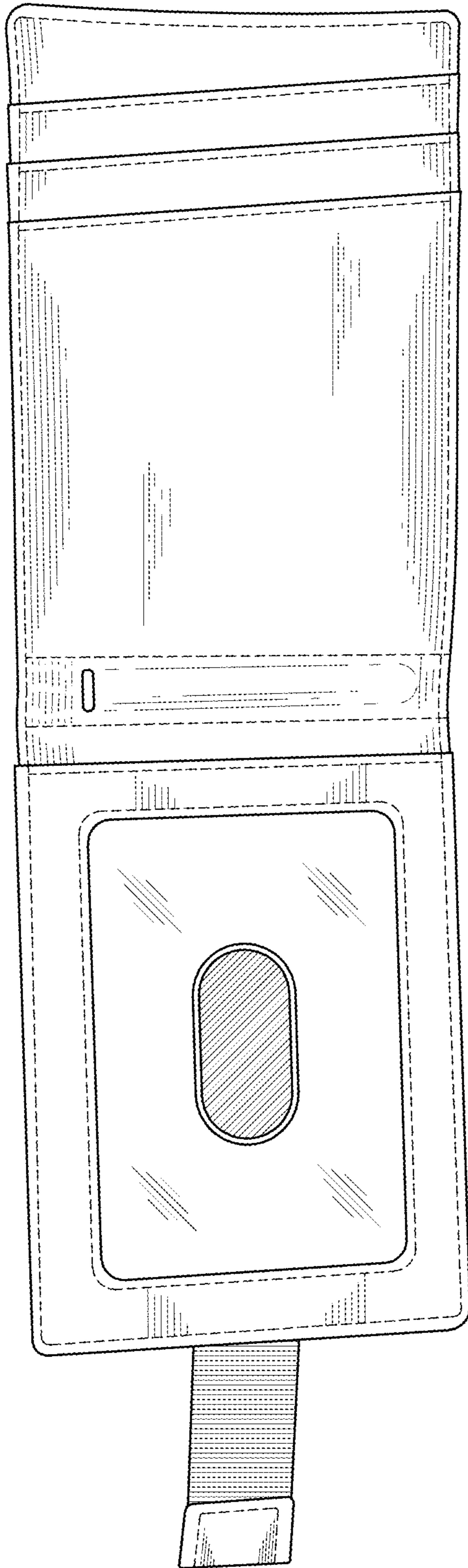

FIG. 3

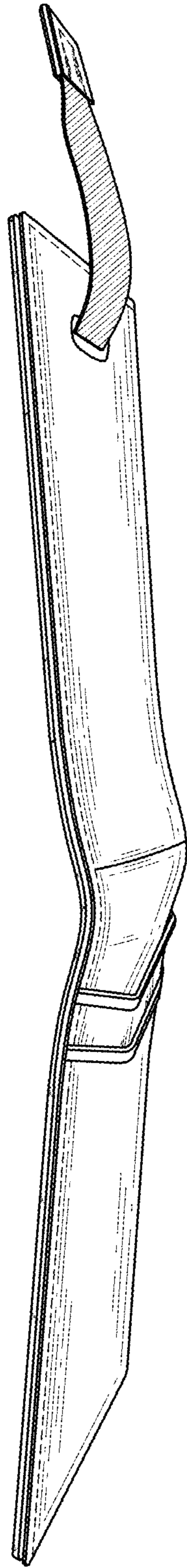

FIG. 4

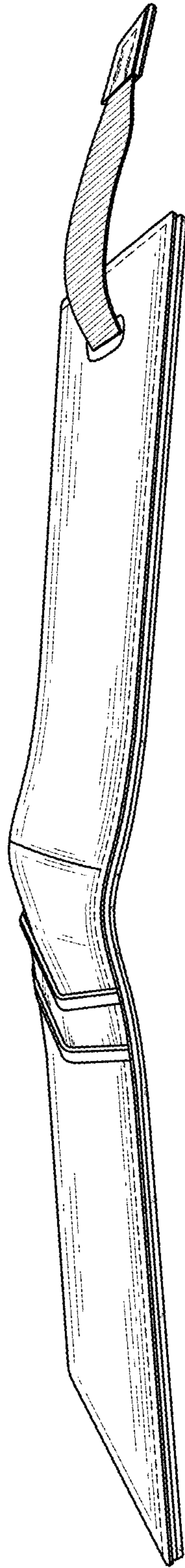

FIG. 5

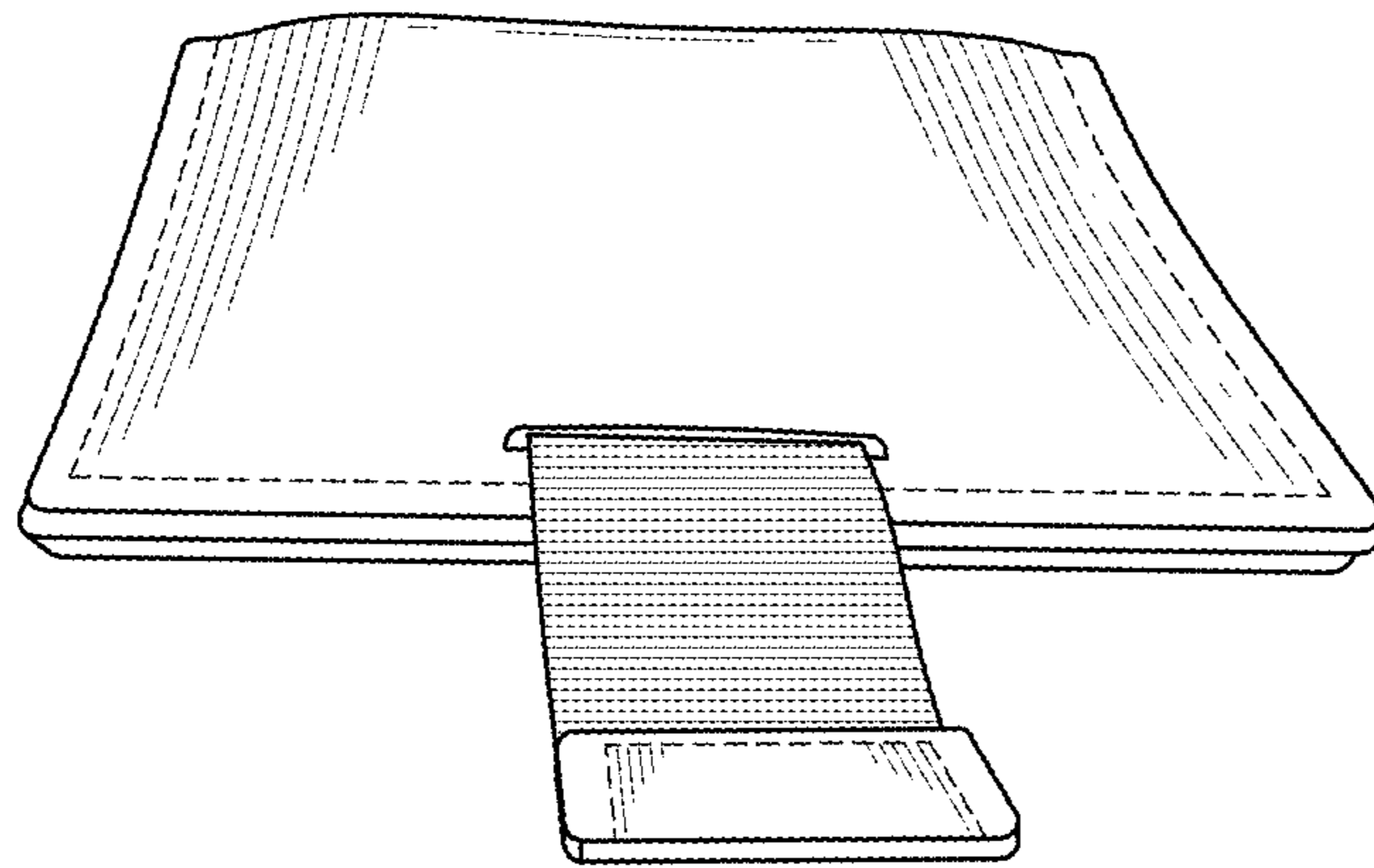

FIG. 6

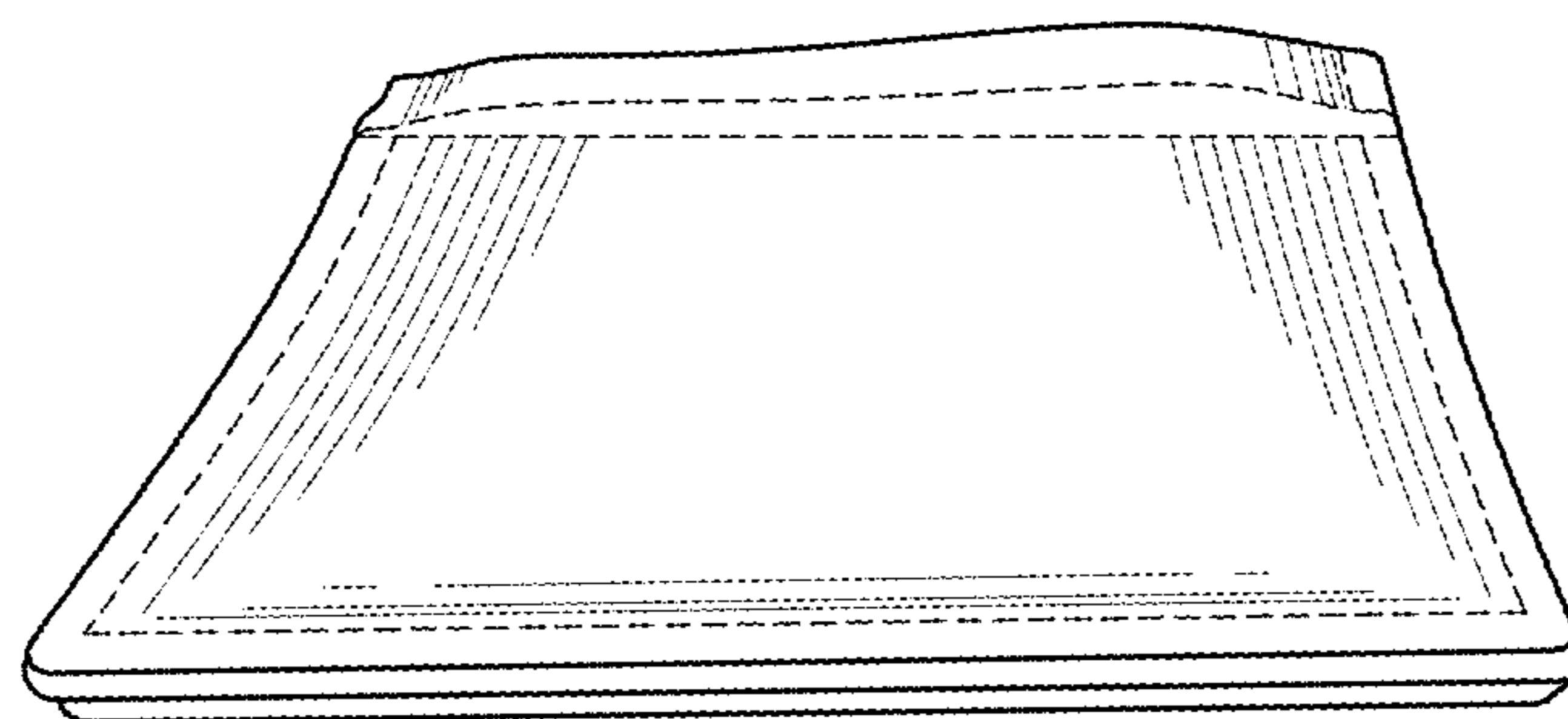

FIG. 7