



US00D891090S

(12) **United States Design Patent**
Cardoso

(10) **Patent No.:** **US D891,090 S**

(45) **Date of Patent:** **** Jul. 28, 2020**

(54) **STYLIZED KEYHOLDER**

(71) Applicant: **Diego Cardoso**, Gilroy, CA (US)

(72) Inventor: **Diego Cardoso**, Gilroy, CA (US)

(**) Term: **15 Years**

(21) Appl. No.: **29/672,116**

(22) Filed: **Dec. 3, 2018**

(51) **LOC (12) Cl.** **03-01**

(52) **U.S. Cl.**
USPC **D3/211**

(58) **Field of Classification Search**
USPC D3/207, 208, 209, 210, 211, 212; D8/33,
D8/34, 38
CPC .. A44B 15/00; Y10T 70/8676; Y10T 24/1379
See application file for complete search history.

(56) **References Cited**

U.S. PATENT DOCUMENTS

| | | | | |
|-------------------|---------|-------------|-------|------------|
| D403,941 S * | 1/1999 | Teetor | | D17/18 |
| D407,430 S * | 3/1999 | Rosenberg | | D17/20 |
| D657,613 S * | 4/2012 | Pierce | | D7/354 |
| D785,315 S * | 5/2017 | Habraken | | D3/207 |
| D838,309 S * | 1/2019 | Trombetti | | D17/20 |
| 10,311,851 B1 * | 6/2019 | Stadnyk | | G10H 3/181 |
| 2019/0156795 A1 * | 5/2019 | Powers | | G10D 1/085 |
| 2019/0371283 A1 * | 12/2019 | Fortoloczki | | G10D 1/085 |

* cited by examiner

Primary Examiner — Kevin K Rudzinski

Assistant Examiner — Amber J Rabie

(57) **CLAIM**

The ornamental design for a stylized keyholder, as shown and described.

DESCRIPTION

FIG. 1 is a top perspective view of a stylized keyholder showing my new design;

FIG. 2 is a bottom perspective view thereof;

FIG. 3 is a front view thereof;

FIG. 4 is a rear view thereof;

FIG. 5 is a left view thereof, wherein the key slots are visible;

FIG. 6 is a right view thereof;

FIG. 7 is a top view thereof, wherein the thumb-switch slots are visible;

FIG. 8 is a bottom perspective thereof;

FIG. 9 is a top perspective view thereof, wherein one key is deployed;

FIG. 10 is an alternate top perspective view thereof, wherein one key is deployed;

FIG. 11 is a top perspective view thereof, wherein both keys are deployed; and,

FIG. 12 is an alternate top perspective view thereof, wherein both keys are deployed.

The broken line showing the following features: plates, dials, switches, and other protuberances in FIG. 1-12; the extended keys in FIGS. 9, 10, 11, and 12; and the internal contours and volume in FIGS. 1, 2, 5, 7, 9, 10, 11, and 12 is included for the purpose of illustrating environmental structure and forms no part of the claimed design.

1 Claim, 12 Drawing Sheets

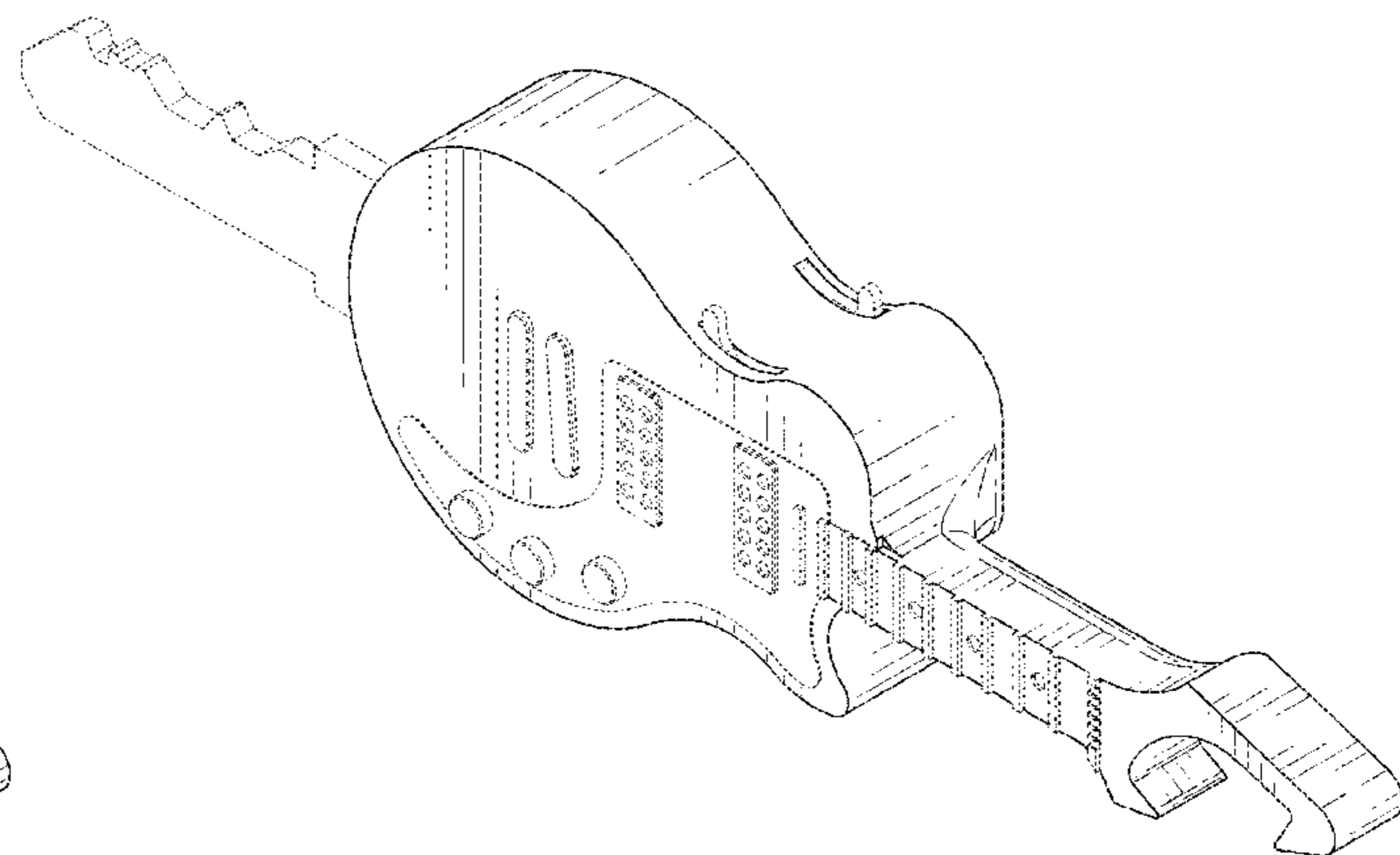
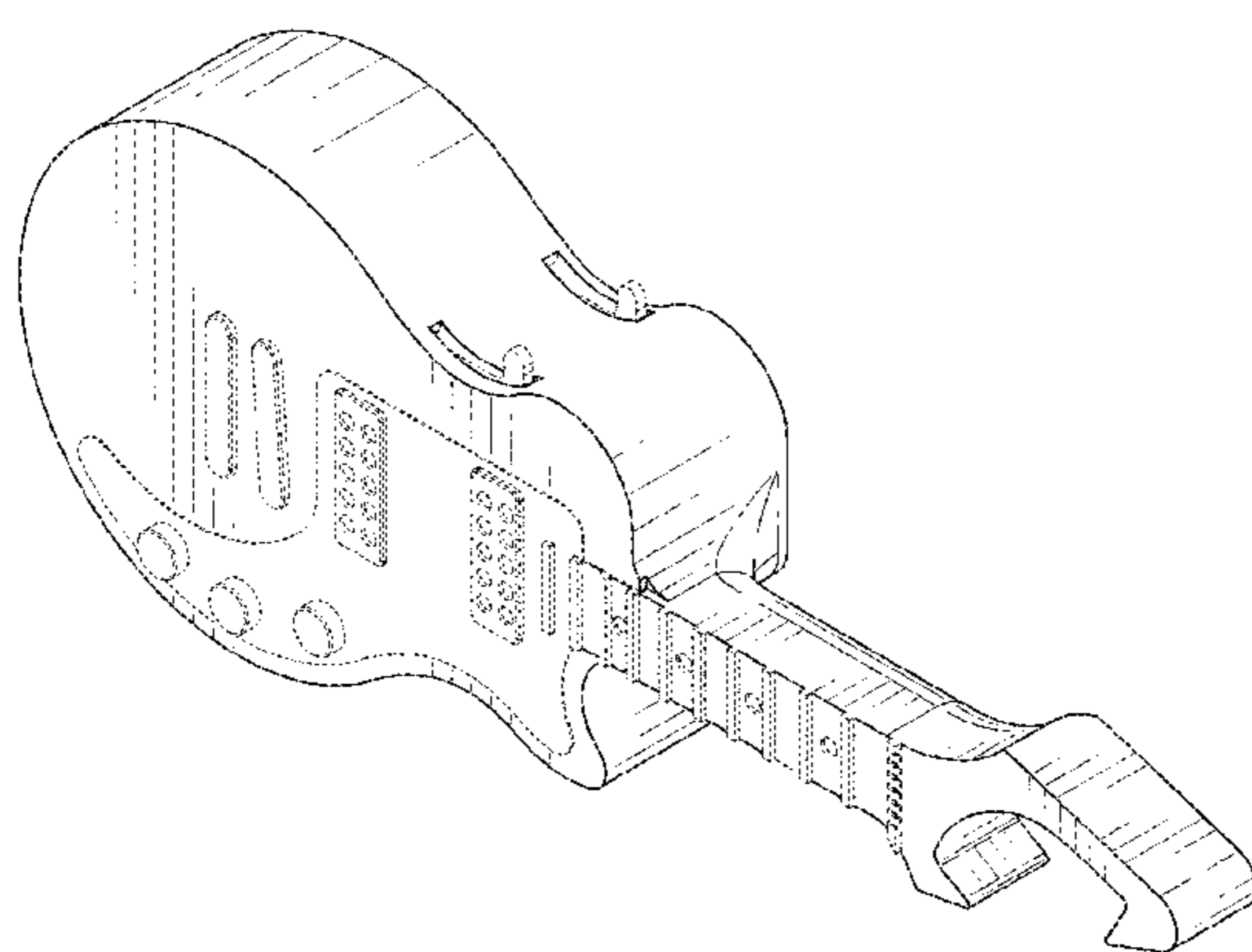

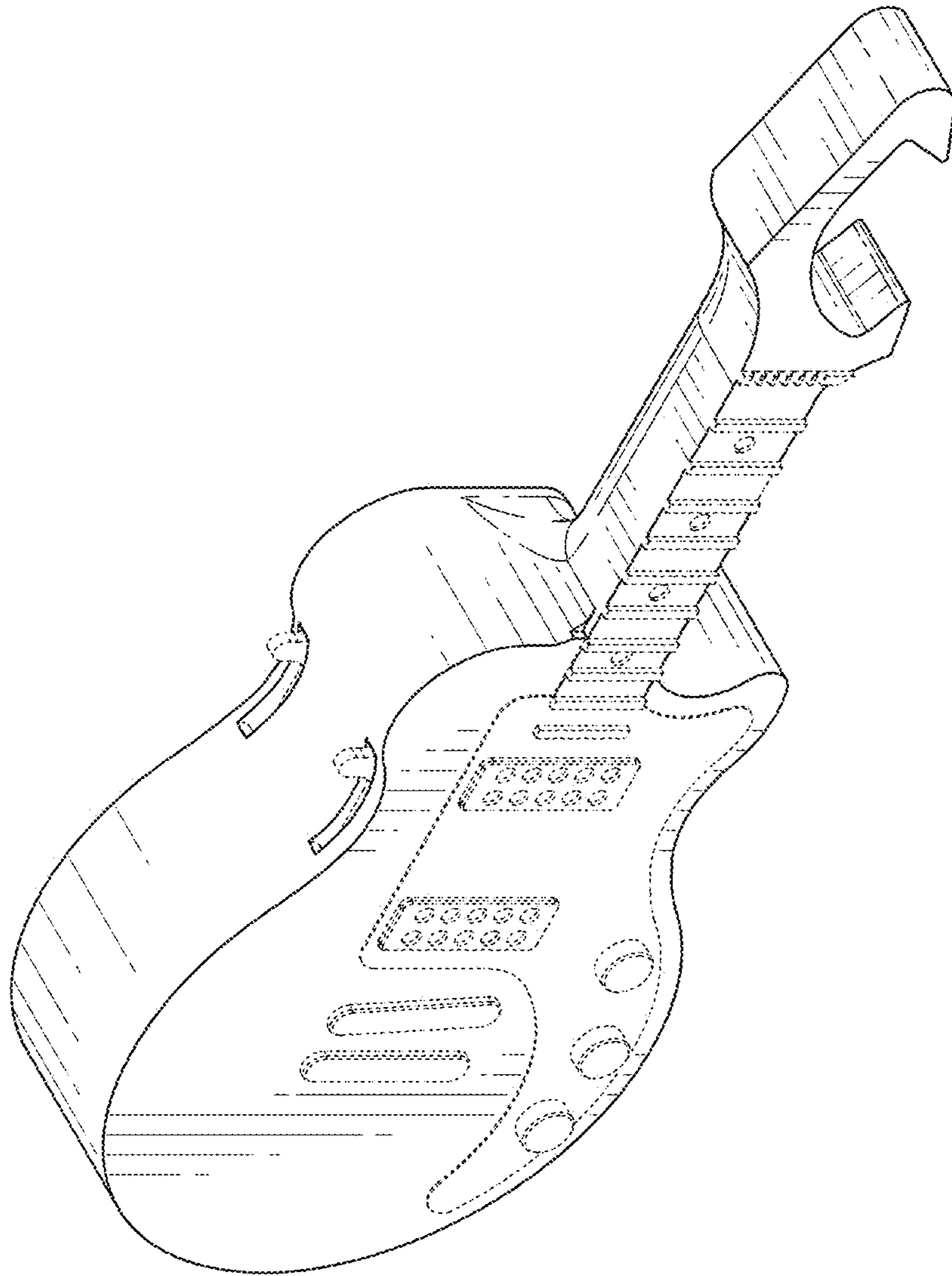

FIG. 1

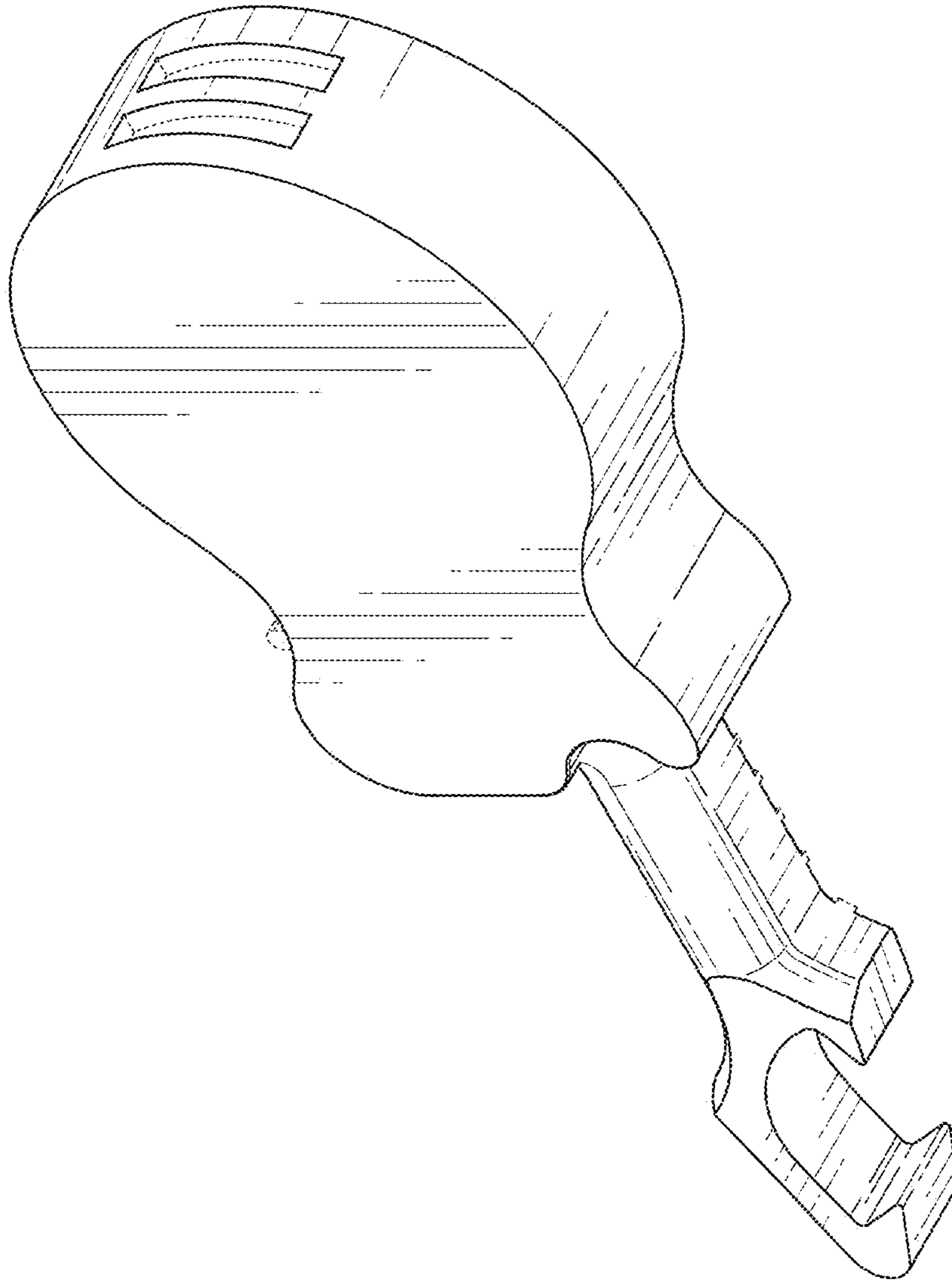

FIG. 2

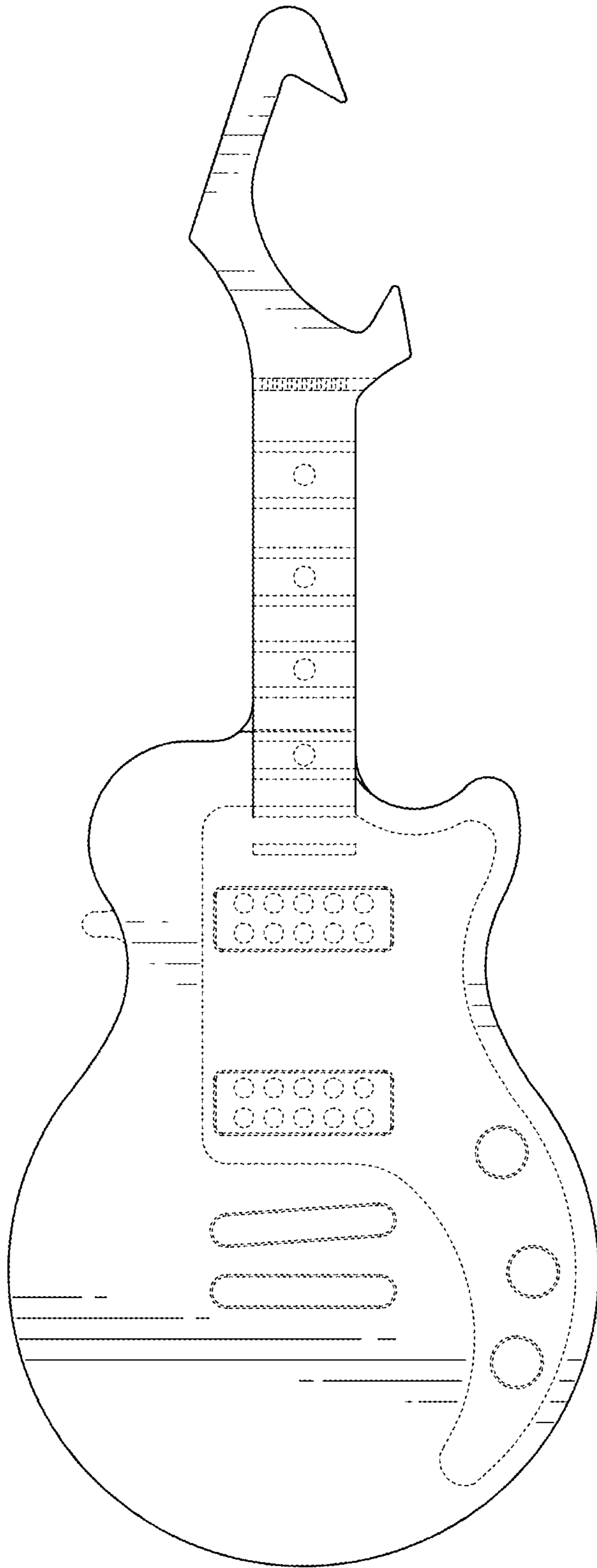

FIG. 3

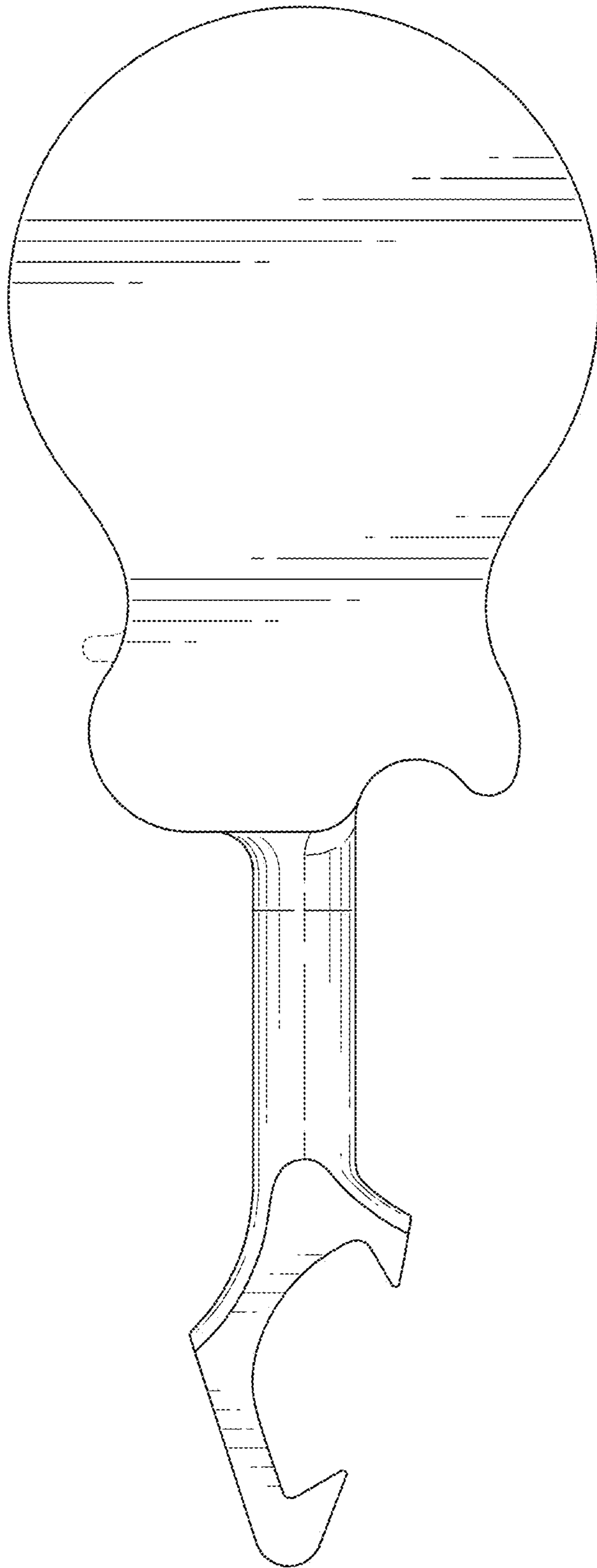

FIG. 4

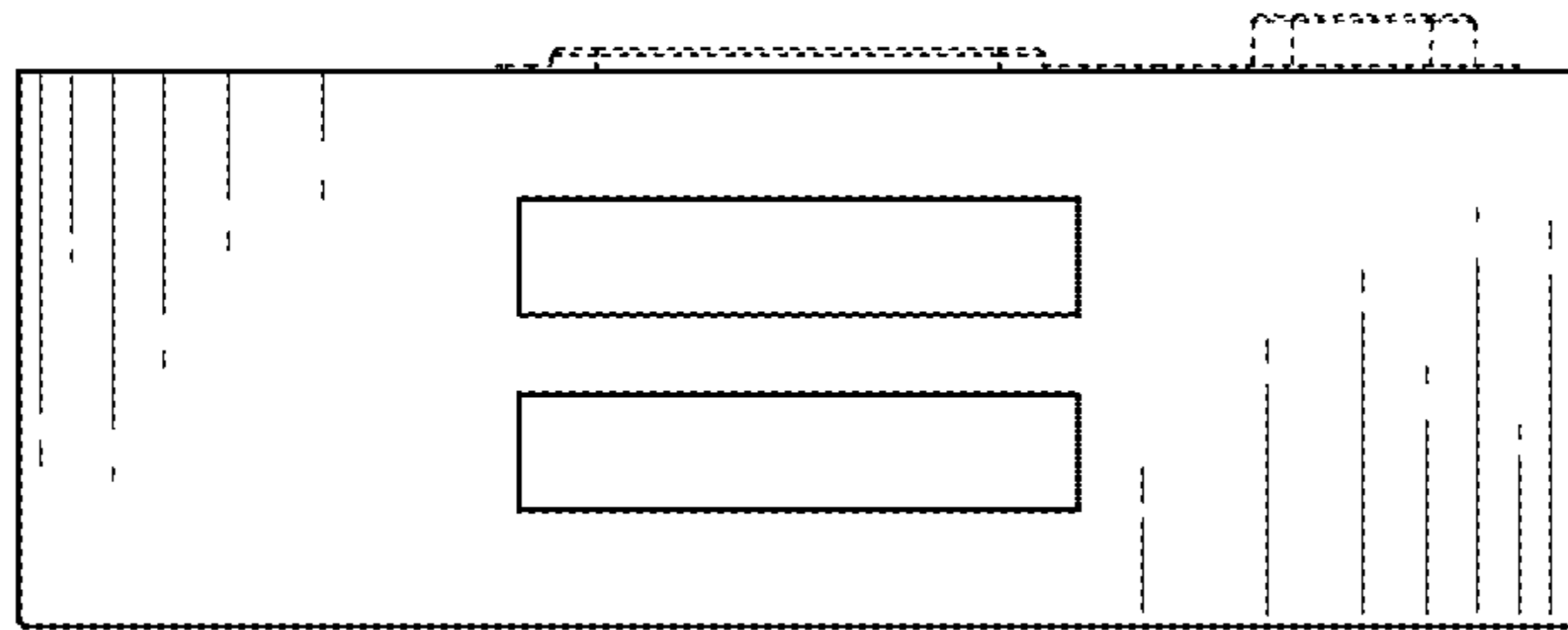

FIG. 5

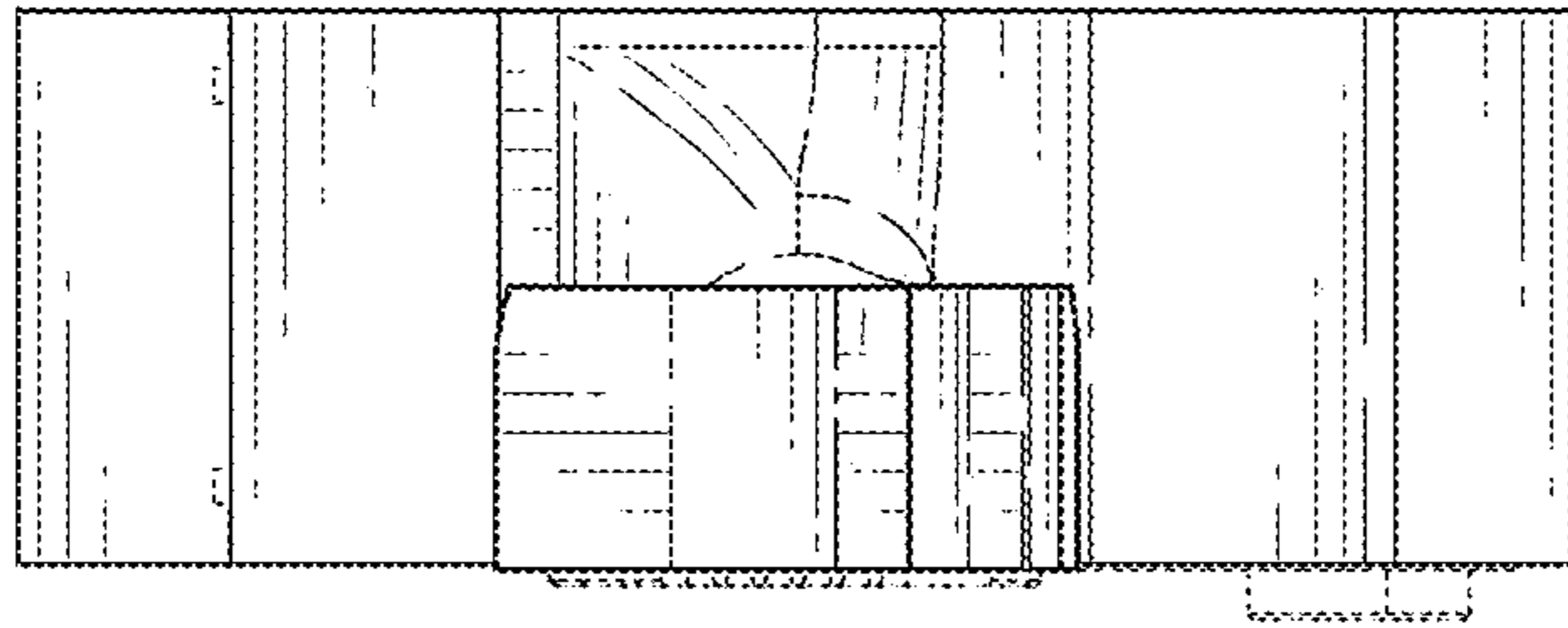

FIG. 6

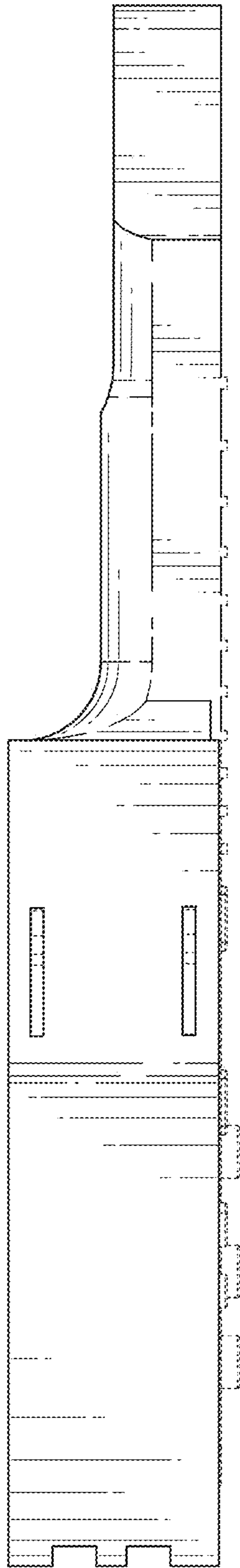

FIG. 7

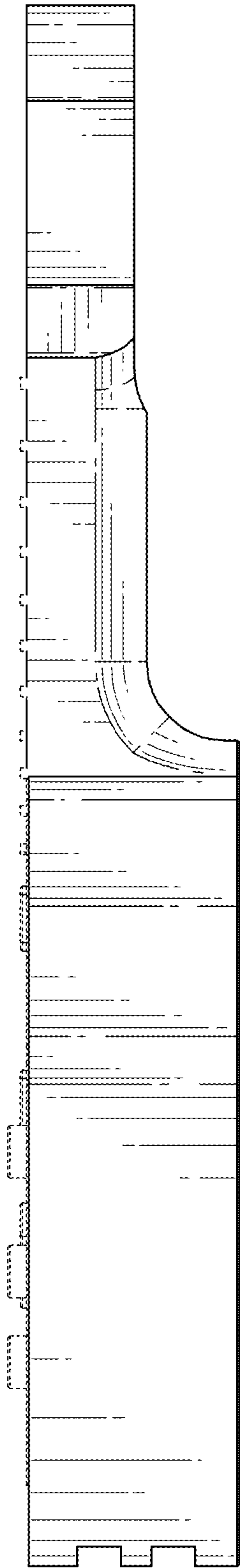

FIG. 8

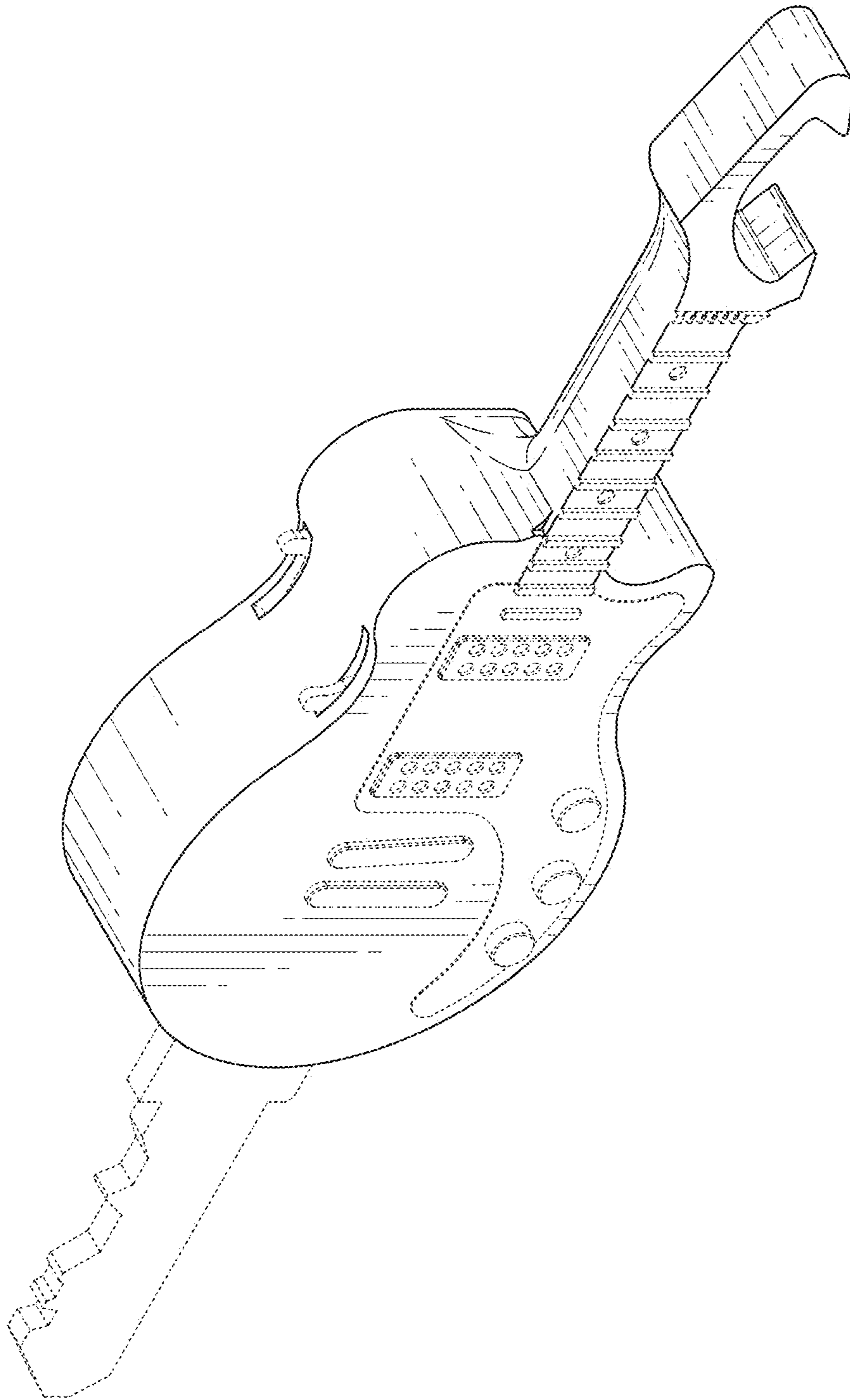

FIG. 9

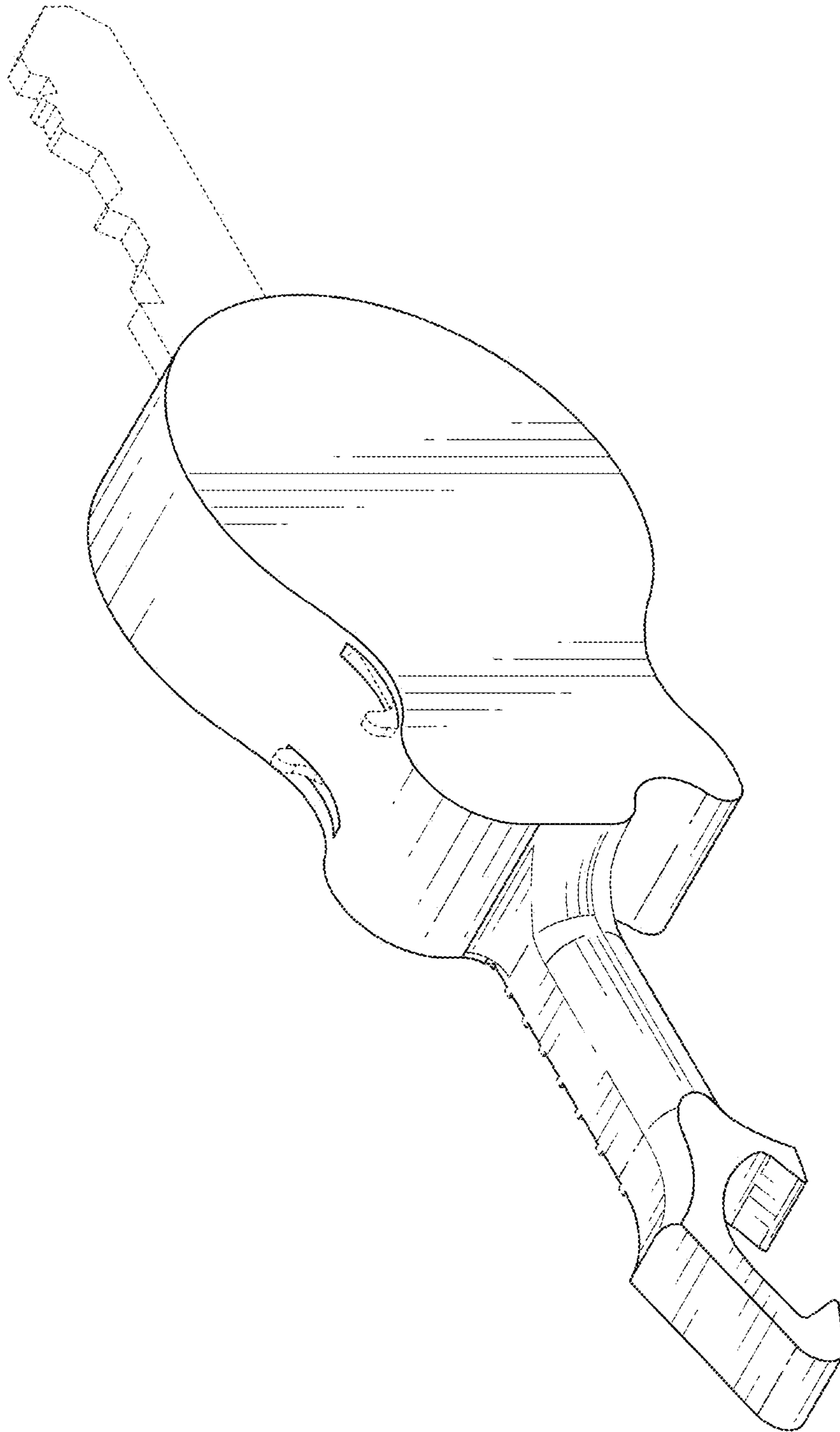

FIG. 10

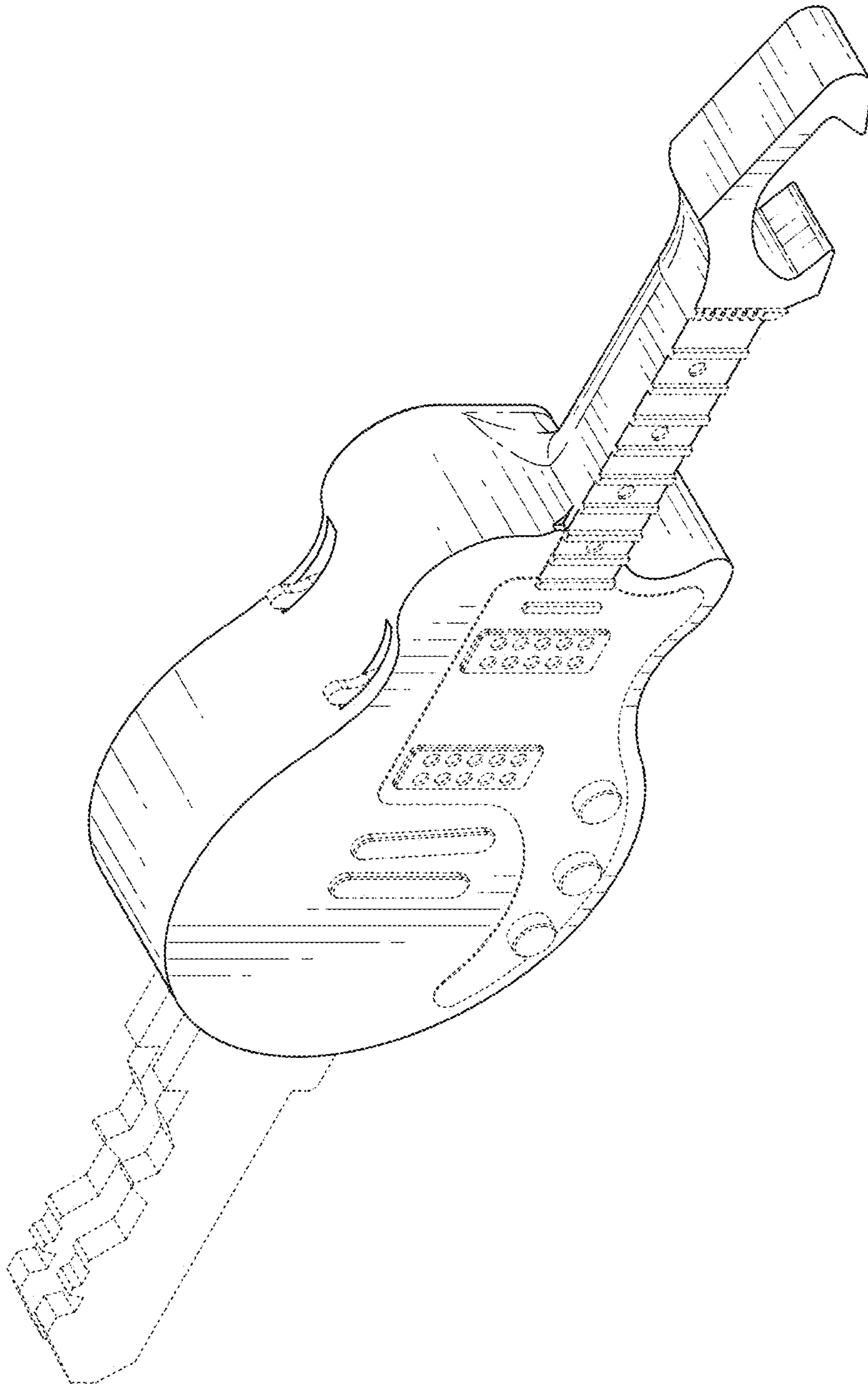

FIG. 11

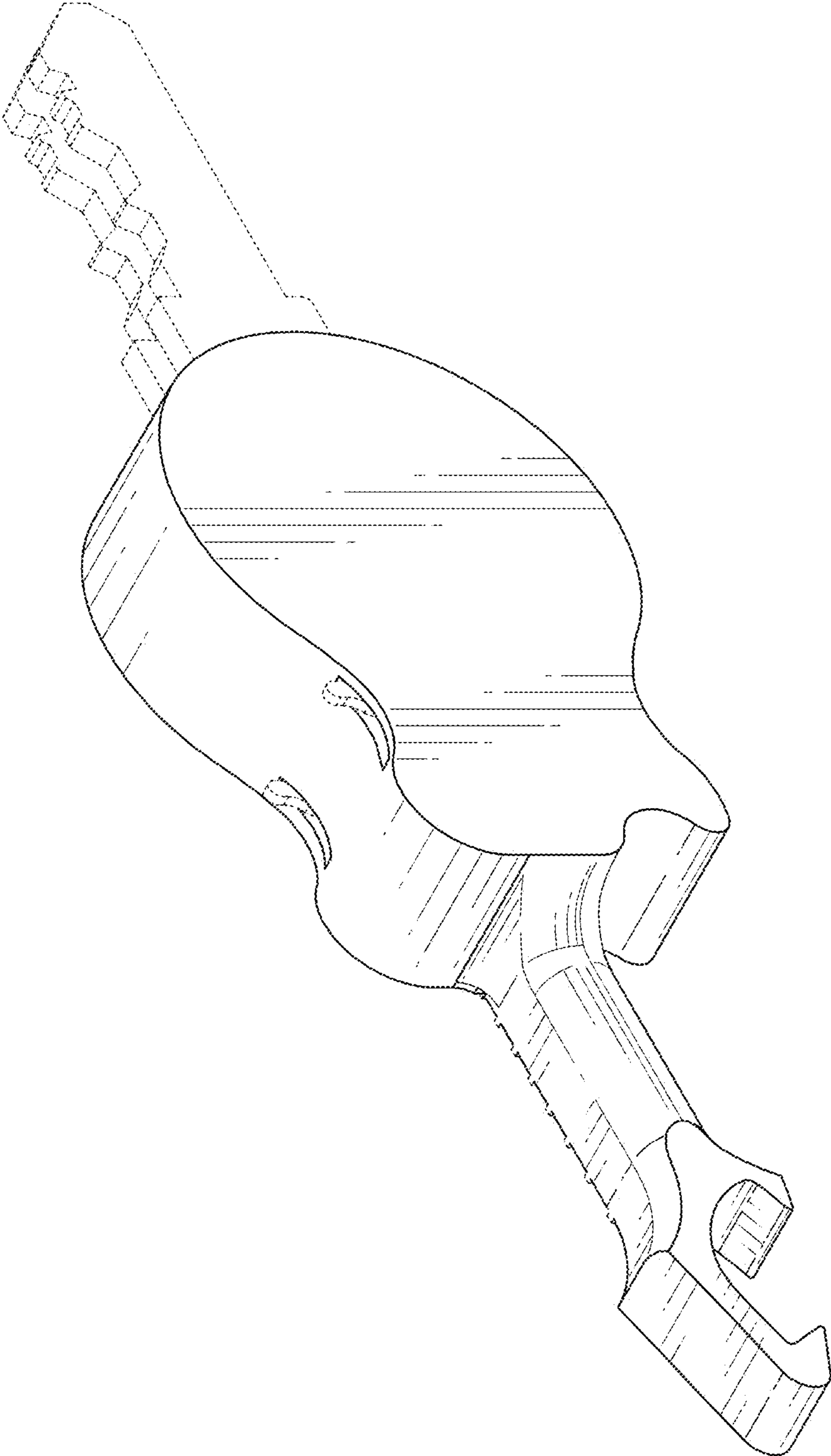

FIG. 12