

US00D891047S

(12) **United States Design Patent** (10) **Patent No.:** **US D891,047 S**
Gavrieli et al. (45) **Date of Patent:** **** Jul. 28, 2020**

(54) **DUAL-SOLE SHOE WITH STRIPE, COLOR
 OUTPATCH SOLE, AND CONTRASTING
 UPPER**

(56) **References Cited**

U.S. PATENT DOCUMENTS

- (71) Applicant: **Gavrieli Brands LLC**, Beverly Hills,
 CA (US)
- (72) Inventors: **Kfir Gavrieli**, Beverly Hills, CA (US);
Dikla Gavrieli, Beverly Hills, CA (US)
- (73) Assignee: **Gavrieli Brands LLC**, Beverly Hills,
 CA (US)
- (**) Term: **15 Years**
- (21) Appl. No.: **29/674,158**
- (22) Filed: **Dec. 19, 2018**

249,086	A	11/1881	Pienovi	
773,850	A	11/1904	Cooper et al.	
830,941	A	9/1906	Walden	
1,208,209	A	12/1916	Prince	
1,214,666	A	2/1917	Ford	
1,519,009	A	12/1924	Reina	
1,525,848	A *	2/1925	Bonaventure	A43B 5/12 36/8.3
1,587,377	A	6/1926	Grosjean	
1,650,466	A	11/1927	Righter	
2,224,590	A	12/1940	Boivin	
2,268,777	A	1/1942	Scholl	
D133,819	S *	9/1942	Harris	D2/939
D135,791	S	6/1943	Beebe	
2,323,563	A	7/1943	Nugent	
2,342,882	A	2/1944	Meltzer	
D141,871	S	7/1945	Braun	
2,383,585	A	8/1945	Bindner	
D149,685	S *	5/1948	Sandler	D2/935
D150,729	S *	8/1948	Sandler	D2/923
D166,090	S *	3/1952	Maling	A43B 13/14 D2/897
2,772,488	A	12/1956	Meltzer	
2,904,814	A	9/1959	Scholl	
3,148,378	A	9/1964	Tibbitts	
D200,897	S *	4/1965	Mitchell	D2/919
D220,464	S	4/1971	Hayashi	
D247,396	S *	3/1978	Schlerth	D2/939
4,412,393	A	11/1983	Terlizzi, Jr. et al.	
D275,525	S	9/1984	Nakao	
4,674,206	A	6/1987	Lyden	
D295,692	S *	5/1988	Zuidema	D2/950
D300,085	S	3/1989	Ito et al.	
RE33,018	E	8/1989	Ostrander	
4,899,412	A	2/1990	Ganon	
D316,773	S	5/1991	Valle	
5,012,541	A	5/1991	Ganon	
D339,669	S *	9/1993	Miller	D2/939
5,282,326	A	2/1994	Schroer, Jr. et al.	
5,421,050	A	6/1995	Laganas	
5,699,629	A	12/1997	Munschy	
5,746,014	A	5/1998	Tanemoto	
D420,785	S	2/2000	Perez	
6,055,745	A	5/2000	Endoh	
6,076,284	A	6/2000	Terlizzi	
6,189,239	B1	2/2001	Gasparovic et al.	
6,338,207	B1	1/2002	Chang	
D457,292	S *	5/2002	Sessa	D2/949
D461,947	S	8/2002	Merceron	

Related U.S. Application Data

- (63) Continuation of application No. 29/578,796, filed on
 Sep. 23, 2016, now Pat. No. Des. 837,495, which is
 a continuation of application No. 29/509,209, filed on
 Nov. 14, 2014, now abandoned, application No.
 29/674,158, which is a continuation of application
 No. 15/905,239, filed on Feb. 26, 2018, which is a
 continuation of application No. 15/204,763, filed on
 Jul. 7, 2016, now Pat. No. 9,930,925, which is a
 continuation of application No. 14/266,599, filed on
 Apr. 30, 2014, now Pat. No. 9,398,786, which is a
 continuation of application No. 13/207,397, filed on
 Aug. 10, 2011, now Pat. No. 8,745,893.
- (51) **LOC (12) Cl.** **02-04**
- (52) **U.S. Cl.**
 USPC **D2/939**
- (58) **Field of Classification Search**
 USPC D2/896, 900, 919-921, 925, 939, 947,
 D2/950, 969, 971; 36/1, 83, 8.1-8.3, 9 R,
 36/45-58, 104, 108, 76 R
 CPC A43B 21/00; A43B 21/02; A43B 21/06;
 A43B 9/14; A43B 1/0045; A43B 13/10;
 A43B 13/12; A43B 23/06; A43B 23/07;
 A43B 1/0036; A43B 5/12
 See application file for complete search history.

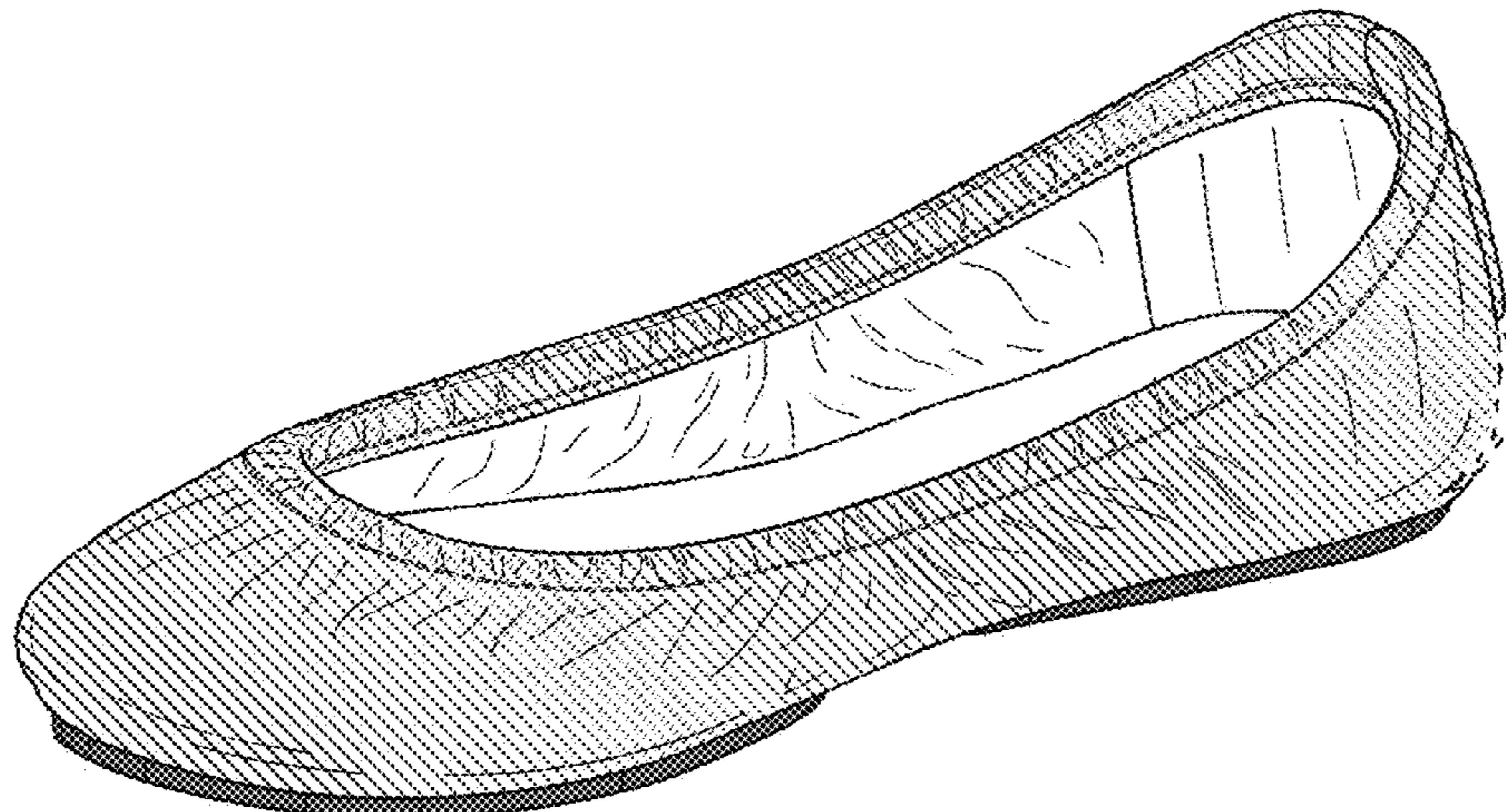

US D891,047 S

Page 2

6,588,124 B2	6/2003	Morrone		D683,936 S *	6/2013	Gavrieli	A43B 13/14
D476,798 S	7/2003	Reynolds et al.					D2/939
D498,041 S	11/2004	McClaskie		8,468,723 B2	6/2013	Malka-Harari	
D500,191 S *	12/2004	Belley	D2/969	D686,812 S	7/2013	Gavrieli et al.	
D501,706 S	2/2005	McClaskie		8,510,975 B2	8/2013	Krikelis	
6,857,203 B2	2/2005	Minden		D688,853 S *	9/2013	Gavrieli	A43B 3/12
6,895,693 B2	5/2005	Baruck					D2/939
6,978,557 B2	12/2005	Lee		D688,854 S *	9/2013	Gavrieli	A43B 13/186
7,032,327 B1	4/2006	Tartaglia et al.					D2/939
7,036,244 B1	5/2006	Finch		D688,855 S *	9/2013	Gavrieli	A43B 13/16
D527,513 S	9/2006	Della Valle					D2/939
D529,513 S	10/2006	Aketa		D689,270 S *	9/2013	Gavrieli	A43B 13/14
D531,790 S	11/2006	Wurzburg					D2/939
D534,341 S *	1/2007	Choi	D2/896	D689,271 S *	9/2013	Gavrieli	A43B 3/12
D542,513 S	5/2007	Amado et al.					D2/939
D556,990 S	12/2007	Cabados		D689,272 S *	9/2013	Gavrieli	A43B 3/108
7,337,558 B2	3/2008	Terlizzi et al.					D2/939
D567,485 S	4/2008	James		D690,914 S *	10/2013	Gavrieli	A43B 13/186
D570,488 S	6/2008	Kirksey et al.					D2/939
D571,084 S	6/2008	Comeau		D690,915 S *	10/2013	Gavrieli	A43B 3/10
D571,548 S	6/2008	Seamans					D2/939
D571,989 S	7/2008	Siegal		D696,500 S	12/2013	Hunt	
D580,640 S	11/2008	Wurzburg		D699,424 S	2/2014	Hamm	
D582,638 S	12/2008	Ringholz		8,661,714 B2	3/2014	Sussmann	
7,496,982 B2	3/2009	Clark et al.		8,745,893 B2	6/2014	Gavrieli et al.	
7,506,459 B2	3/2009	Grisoni et al.		8,973,287 B2	3/2015	Shibata	
D591,031 S	4/2009	Cofinco		2002/0078591 A1	6/2002	Morrone	
D593,295 S *	6/2009	Belley	A43B 3/12	2002/0129519 A1	9/2002	Cahan	
			D2/969	2003/0070319 A1	4/2003	Minden	
D593,297 S *	6/2009	Belley	A43B 13/16	2003/0121176 A1	7/2003	Baruck	
			D2/969	2004/0025377 A1	2/2004	Brannon	
D593,307 S *	6/2009	Belley	A43B 13/186	2005/0022421 A1	2/2005	Bruckner	
			D2/969	2005/0115115 A1	6/2005	Lacey	
D599,093 S *	9/2009	Issler	A43B 13/14	2005/0217148 A1	10/2005	Connolly et al.	
			D2/925	2005/0262734 A1	12/2005	Cheng	
D604,030 S	11/2009	Wilson		2006/0086005 A1	4/2006	Yerian	
D607,194 S	1/2010	Zagula		2006/0156576 A1	7/2006	Sloan	
D610,332 S	2/2010	Raichle		2007/0074424 A1	4/2007	Lin	
D610,785 S	3/2010	Smith		2007/0204482 A1	9/2007	Gibson-Collinson	
D612,140 S	3/2010	Moon		2007/0204483 A1	9/2007	Kirsch et al.	
D612,141 S	3/2010	Moon		2008/0052964 A1	3/2008	Taylor	
7,694,435 B1	4/2010	Kiser et al.		2008/0086912 A1	4/2008	Wilkenfeld	
D615,737 S	5/2010	Feller		2008/0110059 A1	5/2008	Kuramoto et al.	
7,735,244 B1	6/2010	Ameche		2009/0019732 A1	1/2009	Sussmann	
7,743,530 B2	6/2010	Truelsen		2009/0193685 A1	8/2009	Wilson	
D618,891 S	7/2010	McClaskie		2009/0205222 A1	8/2009	Mclinden	
7,757,408 B2	7/2010	McClaskie		2009/0272009 A1	11/2009	Weisner et al.	
D630,829 S	1/2011	Weisner		2010/0011625 A1	1/2010	Percival	
D632,881 S	2/2011	Rosenberg		2010/0018080 A1	1/2010	Smith	
7,926,203 B2	4/2011	Wilkenfeld		2010/0050469 A1	3/2010	Chen	
7,966,747 B2	6/2011	Wilkenfeld et al.		2010/0095557 A1	4/2010	Jarvis	
D640,861 S	7/2011	Wilkenfeld		2010/0115793 A1	5/2010	Kraisosky	
8,020,320 B2	9/2011	Gillespie		2010/0122475 A1	5/2010	Purrington	
8,127,468 B2	3/2012	Morgan		2010/0146822 A1	6/2010	MacGregor	
D657,543 S	4/2012	Bove		2010/0212186 A1	8/2010	Cheng	
D659,960 S	5/2012	Bizzo		2010/0275462 A1	11/2010	Pucci	
8,230,619 B2	7/2012	Salvatelli		2010/0281713 A1	11/2010	Pantazes	
D664,755 S	8/2012	Gavrieli et al.		2015/0089843 A1	4/2015	Gavrieli	
D665,157 S	8/2012	Wu					
8,240,067 B2	8/2012	Sussmann					
8,245,420 B2	8/2012	Wilson					
D668,027 S	10/2012	Millieret					
D668,438 S	10/2012	Millieret					
D668,847 S *	10/2012	Gavrieli	A43B 3/12				
			D2/925				
D668,848 S *	10/2012	Gavrieli	A43B 3/108				
			D2/925				
D668,849 S	10/2012	Pozzi					
D668,850 S	10/2012	Pozzi					
D672,542 S	12/2012	Gray et al.					
D676,634 S *	2/2013	Gavrieli	A43B 13/186				
			D2/925				
D681,927 S *	5/2013	Gavrieli	A43B 13/16				
			D2/939				
D681,928 S *	5/2013	Gavrieli	A43B 13/14				
			D2/939				
D681,929 S *	5/2013	Gavrieli	A43B 3/24				
			D2/939				

FOREIGN PATENT DOCUMENTS

DE	20	2006	000230	U1	5/2007
GB			2443937	A	5/2008
GB			2 446 205	A	8/2008
TW			D119165		10/2007

OTHER PUBLICATIONS

Third Party Submission Under 37 CFR 1.290 regarding U.S. Appl. No. 15/905,239, Feb. 9, 2019, 94 pages.

Order Granting TRO (D.I. 11), *Gavrieli Brands LLC vs. Soto Massini*, Civil Action No. 1:18-cv-00462, Mar. 28, 2018, 2 pages.

Defendants' Opposition to Motion for Temporary Restraining Order, Civil Action No. 1:18-cv-00462-GMS, Apr. 1, 2018, 12 pages.

Declaration of Thomas Pichler in Opposition to Tro Request, C.A. No. 1:18-cv-00462-GMS, Apr. 1, 2018, 8 pages.

- Exhibit A to Pichler Declaration ISO TRO Opposition (D.I. 13-1), C.A. No. 1:18-cv-00462-GMS, Apr. 1, 2018, 29 pages.
- Order TRO (D.I. 18), C.A. No. 1:18, Apr. 4, 2018, 3 pages.
- Defendant Soto Massini (USA) Corporation's Answer and Counterclaims to Verified Complaint for Patent Infringement, Trade Dress Infringement, and Unfair Competition, C.A. No. 1:18-cv-00462-GMS, May 1, 2018, 26 pages.
- Defendant Soto Massini (USA) Corporation's Answer to Amended Complaint and Amended Counterclaims, C.A. No. 1:18-cv-00462-GMS, Jun. 5, 2018, 28 pages.
- Defendant Soto Massini (USA) Corporation's Answer to Amended Complaint and First Amended Counterclaims, C.A. No. 1:18-cv-00462-GMS, Jul. 12, 2018, 31 pages.
- Exhibit A to SACC (45-1), Case 1:18-cv-00462-GMS, 3 pages.
- Exhibit B to SACC (45-2), Case 1:18-cv-00462-GMS, 5 pages.
- Exhibit C to SACC (45-3), Case 1:18-cv-00462-GMS, 5 pages.
- Exhibit D to SACC (45-4), Case 1:18-cv-00462-GMS, 4 pages.
- Defendant Soto-USA's Invalidity Contentions, C.A. No. 1:18-cv-00462-MN, 16 pages.
- Redacted Verdict Form (D.I. 144), Case 1:18-cv-00462-GMS, 13 pages.
- Judgement (D.I. 149), C.A. No. 18-462-MN, May 13, 2019, 3 pages.
- Gavrieli Brands, LLC, v. Soto Massini (USA) Corp., et al.*, (full Trial Transcript, C.A. No. 18-462(MN), vol. 1, 733 pages.
- Expert Report of Caroline de Baere (Fed. R. CIV. P. 26(a)(2)(B)), Case No. 18-cv-00462-MN, Mar. 1, 2019, 33 pages.
- Exhibit 23, Infringement Analysis in Light of the Alleged Prior Art, 41 pages.
- Expert Report of Lance Rake, (Fed. R. CIV. P. 26(a)(2)(B), Mar. 1, 2019, 27 pages.
- U.S. Pat. No. 1,525,848, Feb. 10, 1925, B. S. Bonaventure, 3 pages.
- Design U.S. Pat. No. 247,396, Mar. 7, 1978, William A. Schlerth, 2 pages.
- Design U.S. Pat. No. D. 611,693 S, Mar. 16, 2010, Barbara Schwartz, 7 pages.
- Camper Book Excerpt—Nina Right, (pp. 334-335), *The Walking Society*, Lars Müller Publishers, 3 pages.
- Camper History—The Shoes, Every Season We Strive to Reinvent Some of Our Classic Concepts While Continuing to Challenge the Status Quo With New and Original Designs. We Often Find That There Is a Camper Style for Every Walk of Life, 8 pages.
- Tieks by Gavrieli—Comfortable, designer flats you can fit in your purse and wear all day, every day!, Copperhead Snake Print Tieks, <https://web.archive.org/web/20101230062534/http://www.tieks.com:80/>, Dec. 30, 2010, 1 page.
- Tieks by Gavrieli—Comfortable, designer flats you can fit in your purse and wear all day, every day!, Merlot Lizard Print Tieks, <https://web.archive.org/web/20101230062534/http://www.tieks.com:80/>, Dec. 30, 2010, 1 page.
- Tieks by Gavrieli—Comfortable, designer flats you can fit in your purse and wear all day, every day!, Slate Grey Tieks, <https://web.archive.org/web/20101230062534/http://www.tieks.com:80/>, Dec. 30, 2010, 1 page.
- Tieks by Gavrieli—Comfortable, designer flats you can fit in your purse and wear all day, every day!, Camel, <https://web.archive.org/web/20101230062534/http://tieks.com:80/>, Dec. 30, 2010, 1 page.
- Tieks by Gavrieli—Comfortable, designer flats you can fit in your purse and wear all day, every day!, Lilac, <https://web.archive.org/web/20101230062534/http://www.tieks.com:80/>, Dec. 30, 2010, 1 page.
- Tieks by Gavrieli—Comfortable, designer flats you can fit in your purse and wear all day, every day!, Leopard Print, <https://web.archive.org/web/20101230062534/http://www.tieks.com:80/>, Dec. 30, 2010, 1 page.
- Tieks by Gavrieli—Comfortable, designer flats you can fit in your purse and wear all day, every day!, the Tieks eGift card . . . Always the perfect fit, <https://web.archive.org/web/20101230062534/http://www.tieks.com:80/>, Dec. 30, 2010, 1 page.
- Tieks by Gavrieli—Comfortable, designer flats you can fit in your purse and wear all day, every day!, Copperhead Snake Print, <https://web.archive.org/web/20110222174850/http://www.tieks.com:80/>, Feb. 22, 2011, 1 page.
- Tieks by Gavrieli—Comfortable, designer flats you can fit in your purse and wear all day, every day!, Patent Tiek Blue, <https://web.archive.org/web/20110222174850/http://www.tieks.com:80/>, Feb. 22, 2011, 1 page.
- Tieks by Gavrieli—Comfortable, designer flats you can fit in your purse and wear all day, every day!, Tangerine, <https://web.archive.org/web/20110222174850/http://www.tieks.com:80/>, Feb. 22, 2011, 1 page.
- Tieks by Gavrieli—Fashionable Flats That Fit in Your Purse California Navy, <https://web.archive.org/web/20100516173039/http://www.tieks.com:80/california-navy.html>, May 16, 2010, 1 page.
- Tieks by Gavrieli—Fashionable Flats That Fit in Your Purse Cardinal Red, <https://web.archive.org/web/20100516173045/http://www.tieks.com:80/cardinal-red.html>, May 16, 2010, 1 page.
- Tieks by Gavrieli—Fashionable Flats That Fit in Your Purse Metallic Gold, <https://web.archive.org/web/20100516173106/tieks.com/metallic-gold.html>, May 16, 2010, 1 page.
- Tieks by Gavrieli—Fashionable Flats That Fit in Your Purse Patent Tiek Blue, <https://web.archive.org/web/20100516173130/http://www.tieks.com:80/tiek-blue.html>, May 16, 2010, 1 page.
- Tieks by Gavrieli—Fashionable Flats That Fit in Your Purse Splash Page, The Ballet Flat . . . Reinvented, <https://web.archive.org/web/20100513055818/https://tieks.com/>, May 13, 2010, 1 page.
- Tieks by Gavrieli—Fashionable Flats That Fit in Your Purse Splash Page, Ballet Flats . . . with a Bonus, <https://web.archive.org/web/20100513055818/https://tieks.com/>, May 13, 2010, 1 page.
- Tieks by Gavrieli—Fashionable Flats That Fit in Your Purse Splash Page, Going Places? Take Tieks. <https://web.archive.org/web/20100513055818/https://tieks.com/>, May 13, 2010, 1 page.
- Tieks by Gavrieli—Fashionable Flats That Fit in Your Purse Splash Page, Step Into Tieks, <https://web.archive.org/web/20100513055818/https://tieks.com/>, May 13, 2010, 1 page.
- Tieks by Gavrieli—Fashionable Flats That Fit in Your Purse True Blue, <https://web.archive.org/web/20100516173135/http://www.tieks.com:80/true-blue.html>, May 16, 2010, 1 page.
- Tieks by Gavrieli—Fashionable Flats That Fit in Your Purse White Croc Print, <https://web.archive.org/web/20100516173145/http://www.tieks.com:80/white-croc-print.html>, May 16, 2010, 1 page.
- Tieks by Gavrieli—Foldable Fashionable Ballet Flats, Wild Copper, Be a little wild . . . even when you're not., <https://web.archive.org/web/20100819165503/https://tieks.com/>, Aug. 19, 2010, 1 page.
- Tieks by Gavrieli—Foldable Fashionable Ballet Flats, Paradise Blue, The perfect pair for day and night, <https://web.archive.org/web/20100819165503/https://tieks.com/>, Aug. 19, 2010, 1 page.
- Tieks by Gavrieli—Foldable Fashionable Ballet Flats, Obsidian Black, When workdays spill over into party nights., <https://web.archive.org/web/20100819165503/https://tieks.com/>, Aug. 19, 2010, 1 page.
- Tieks by Gavrieli—Foldable Fashionable Ballet Flats, Fuchsia, Sweet and sultry, <https://web.archive.org/web/20100819165503/https://tieks.com/>, Aug. 19, 2010, 1 page.
- Tieks by Gavrieli—Foldable Fashionable Ballet Flats, Tan Croc print Tieks, A timeless texture., <https://web.archive.org/web/20100819165503/https://tieks.com/>, Aug. 10, 2010, 1 page.
- Tieks by Gavrieli—Foldable Fashionable Ballet Flats, Be a little wild . . . even when you're not., <https://web.archive.org/web/20100902020755/https://tieks.com/>, Sep. 2, 2010, 1 page.
- Tieks by Gavrieli—Foldable Fashionable Ballet Flats, Obsidian Black, When workdays spill over into party nights. <https://web.archive.org/web/20100902020755/https://tieks.com/>, Sep. 2, 2010, 1 page.
- Tieks by Gavrieli—Foldable Fashionable Ballet Flats, Tan Croc Print, A timeless texture, <https://web.archive.org/web/20100902020755/https://tieks.com/>, Sep. 2, 2010, 1 page.
- Tieks by Gavrieli—Foldable Fashionable Ballet Flats, Paradise Blue, The perfect pair for day and night, <https://web.archive.org/web/20100902020755/https://tieks.com/>, Sep. 2, 2010, 1 page.
- Tieks by Gavrieli—Foldable Fashionable Ballet Flats, Fuchsia, Sweet and sultry, <https://web.archive.org/web/20100902020755/https://tieks.com/>, Sep. 2, 2010, 1 page.
- Tieks by Gavrieli—Foldable Fashionable Ballet Flats, Tiek Blue Tieks, Let yourself shine, <https://web.archive.org/web/20100902020755/https://tieks.com/>, Sep. 2, 2010, 1 page.

Examination Report for AU 341324, 3 pgs., dated Oct. 24, 2012.

Letter from TMI and Associates with Office Action, 2 pgs, dated Sep. 19, 2012 <http://www.payless.com/store/?&TLC=Womens&SLC=WomensNewArrivals&BLC=WomensNewArrivalsNewArrivals&With+Regular&ItemCode=60131&LotNumber=062642&Type=Adult&Popularity=637&Descriptvein>.

Taiwanese Office Action for TW 101300726, 10 pgs., dated Sep. 6, 2012.

"The Love List, Tieks by Gavrieli—Foldable Ballet Flats," <http://thelovelist-carly.blogspot.com.au/2010/09/tieks-by-gavrieli-foldable-ballet.html>, 2 pgs., Sep. 12, 2010.

"Tieks by Gavrieli," <http://tieks.com>, 1 pg., retrieved Mar. 13, 2013 from URL.

"Try It Mummy!, Tieks by Gavrieli," <http://tryitmummy.blogspot.com.au/2010/12/tieks-by-gavrieli.html>, 3 pgs., Dec. 9, 2010.

"Wearability—Real People Style, What came first, the City Flat or the Tieks," <http://wearability.posterous.com/what-came-first-the-city-flat-or-the-tieks>, 2 pgs., Aug. 29, 2010.

"The Ballet Flat . . . Reinvented; Ballet Flats . . . with a Bonus; Step Into Tieks; Going Places? Take Tieks," <http://web.archive.org/web/2010052004346/http://www.tieks.com/>; 4 pgs., May 24, 2010.

"Tieks—Comfortable designer flats you can fit in your purse and wear all day, every day," <http://web.archive.org/web/20110731151555/http://tieks.com/>; 6 pgs., Jul. 31, 2011.

"58th Annual Emmy Awards," http://spoonsforksandfashion.blogspot.com/2006_08_01_archive.html, depicting Nine West flats, 2 pgs., Aug. 1, 2006.

Pictures of Nine West flats sold in 2006, 3 pgs.

"I Love a Good Ballet Flat!," <http://dressupfiles.com/i-love-a-good-ballet-flat>, depicting Sue London flats, 3 pgs., Sep. 3, 2010.

Pictures of Sue London flats sold in 2010, 2 pgs.

"Miss Cathie Reviews: The Yosi Samra Foldable Ballet Flat . . .," <http://www.misscathie.com/2010/01/miss-cathie-reviews-the-yosi-samra-foldable-ballet-flat/>, depicting Yosi Samra flats, 9 pgs., Jan. 2010.

Pictures of Yosi Samra flats sold in 2010, 2 pgs.

"Goodbye two thousand ten," http://emmajoyrussell.blogspot.com/2010_12_01_archive.html, depicting Gap flats, 39 pgs., Dec. 1, 2010.

Pictures of Gap flats available for sale in 2010, 9 pgs.

"Our newest design of folding flats-Pink," <https://fitinclouds.wordpress.com/2010/05/16/our-newest-design-of-folding-flats-pink/>, depicting Fit in Clouds flats, 1 pg., May 16, 2010.

"Fit in Clouds Satin Folding Shoes," <http://www.goodhousekeeping.com/product-reviews/clothing/best-ballet-flats/fit-in-clouds-satin-foldable-ballet-flats>, depicting Fit in Clouds flats, 2 pgs., Aug. 2013.

Pictures of Fit in Clouds flats available for sale in 2011, 4 pgs.

"Shoes for Standing," <https://truthinshoes.wordpress.com/2008/07/>, depicting Sam & Libby flats, 2 pgs., Jul. 31, 2008.

"Target Designer Collaboration: Announcing Sam & Libby Shoes for Target," <http://www.therecessionista.com/2012/11/target-designer-collaboration-announcing-sam-libby-shoes-for-target.html>, depicting Sam & Libby flats, 1 pg., Nov. 26, 2012.

Pictures of Sam & Libby flats available for purchase in 2011, 5 pgs.

"Save your soles with Citisoles ballet flats," <http://glamazondiaries.com/2009/07/save-your-soles-with-citisoles-ballet-flats>, depicting Citisoles flats, 3 pgs., Jul. 2009.

Pictures of Citisoles flats available for purchase in 2009, 3 pgs.

"#16 Corso Como Delicious Pumps Review and Giveaway!," <http://www.mommatoldmeblog.com/2011/01/16-corso-como-delicious-pumps-review.html>, depicting Corso Como flats, 8 pgs., Jan. 16, 2011.

Pictures of Corso Como flats available for sale in 2011, 3 pgs.

"Jil Sander navy-lead-ballet-flats-product . . .," www.ebay.com, depicting Jil Sander flats, 4 pgs., Nov. 2013.

Pictures of Jil Sander flats available for sale in 2011, 3 pgs.

"Spare Soles: Shoes That Roll-up & Fold-up," <http://herpackinglist.com/2011/01/spare-soles-shoes/>, depicting Spare Soles flats, 2 pgs., Jan. 2011.

Pictures of Spare Soles flats available for sale in 2011, 5 pgs.

Pictures of Roll-Upz by Spare Soles flats available for sale in 2011, 6 pgs.

"The Cutest Blog, Preppy 50 and Loving Lilly, Ballet Flat Delight," <http://preppy50andlovinglilly.blogspot.com/2011/02/ballet-flat-delight.html>, depicting Henri Bendel flats, 1 pg., Feb. 19, 2011.

Pictures of Henri Bendel flats available for sale in 2011, 4 pgs.

"Mumsnet by parents for parents," http://www.mumsnet.com/Talk/style_and_beauty/a1612000-Anyone-tried-Redfoot-Flatmates-foldable-ballet-pumps, depicting Redfoot Flatmates flats, 1 pg., Nov. 14, 2012.

Pictures of Redfoot Flatmates flats available for sale in 2011, 6 pgs.

"Amazon.com: Customer Reviews: Bloch London Women's Lux Ballet Flat," <http://www.amazon.com/Bloch-London-Womens-Ballet-Flat/product-reviews/B004LWP7YW>, depicting Bloch London flats, 4 pgs., Dec. 11, 2011.

Pictures of Bloch London flats offered for sale in 2011, 11 pgs.

"h&m foldable leopard print flat," <https://8485shops.wordpress.com/2011/06/16/flats-for-7-bucks/shoe1/>, depicting h&m flats, 2 pgs., Jun. 16, 2011.

Pictures of h&m foldable flats offered for sale in 2011, 4 pgs.

"Seekyt—Juicy Couture Ballet Flats—Are They Worth the Money?," <http://seekyt.com/juicy-couture-ballet-flats-are-they-worth-the-money/>, 2 pgs., Jun. 3, 2011.

Pictures of Juicy Couture flats offered for sale in 2011, 3 pgs.

"Purse Flats," <http://purseflats.wordpress.com>, depicting Purse Flats by Erica Wilson, 3 pgs., Jul. 12, 2012.

Pictures of Purse Flats by Erica Wilson offered for sale in 2011, 6 pgs.

"Tieks by Gavrieli—Comfortable, designer flats you can fit in your purse and wear all day . . .," <http://web.archive.org/web/20110202210649/http://www.tieks.com/>, 8 pgs., Feb. 2, 2011.

"Carolina M. M. Gonzalez > Tieks by Gavrieli," http://m2.facebook.com/Tieks?y=timeline&filter=2&timecutoff=1406427986&page=17§ionLoadingID=m_timeline_loading_div_1293868799_1262332800_8_17&timeend=1293868799×tart=1262332800&tm=AQDOvqhWQPN_Nbwm&refid=17, 1 pg. Jan. 26, 2010.

"The Shoes Oprah Would Wear to Work (if She Had to Walk)," <http://www.inc.com/30under30/christina-desmarais/kfir-gavrieli-and-elram-gavrieli-founders-of-tieks.html>, 2 pgs., Jul. 2, 2012.

"Tieks by Gavrieli," http://m2.facebook.com/Tieks?v=timeline&filter=2&timecutoff=1406427986&page=14§ionLoadingID=m_timeline_loading_div_1293868799_1262332800_8_14&timeend=1293868799×tart=1262332800&tm=AQDOvqhWQPN_Nbwm&refid=17, 4 pgs., Jan. 26, 2010.

"Mighty Life List, Sensible Shoes," <http://mightygirl.com/2010/08/24/sensible-shoes/>, 11 pgs., Aug. 24, 2010.

"Find! Tieks: Fab & sexy flats for fall," <http://thefabmom.com/2013/08/29/finds-tieks-fab-sexy-flats-for-fall/>, 3 pgs. Aug. 29, 2013.

"Step into Tieks," <http://sliceofpink.typepad.com/blog/2010/09/tieks-1.html>, 5 pgs., Sep. 22, 2010.

"In Need of Flat-Soled Shoes," <http://www.kellywickham.com/mochamomma/2010/10/4/in-need-of-flat-soled-shoes.html>, 4 pgs., Oct. 3, 2010.

"Say Hello to the Flat Shoes You Need for Fall . . . All 88 of Them!," Picture of Adam Tucker Shoe/Slipper, <https://www.facebook.com/search/top/?q=adam%20shoes%20slipper>, last accessed Oct. 28, 2016, dated Oct. 1, 2013, 1 page.

Picture of Adam Tucker Rainbow Shoes, <https://www.facebook.com/search/top/?q=adam%20shoes%20rainbow>, last accessed Oct. 28, 2016, dated Aug. 14, 2013, 1 page.

* cited by examiner

Primary Examiner — Dominic V Simone
(74) *Attorney, Agent, or Firm* — Morgan, Lewis & Bockius LLP

(57)

CLAIM

The ornamental design for a dual-sole shoe with stripe, color outpatch sole, and contrasting upper, as shown and described.

DESCRIPTION

The file of this patent contains at least one drawing executed in color. Copies of this patent with color drawing(s) will be provided by the Office upon request and payment of the necessary fee.

FIG. 1 is a perspective view of an embodiment of our new design of a dual-sole shoe with stripe, color outpatch sole, and contrasting upper, where the portions of the upper and midsole that contrast with the purple outpatch sole are indicated using a slanted line hatching pattern;

FIG. 2 is a first side view of the design of FIG. 1;

FIG. 3 is a second side view of the design of FIG. 1;

FIG. 4 is a top view of the design of FIG. 1;

FIG. 5 is a bottom view of the design of FIG. 1;

FIG. 6 is a front view of the design of FIG. 1;

FIG. 7 is a back view of the design of FIG. 1;

FIG. 8 is a perspective view of another embodiment of our new design of a dual-sole shoe with stripe, color outpatch sole, and contrasting upper, where the color portions are indicated using the USPTO convention of dashed vertical lines for violet or purple, and where the portions of the upper and midsole that contrast with the outpatch sole are indicated using a slanted line hatching pattern;

FIG. 9 is a first side view of the design of FIG. 8;

FIG. 10 is a second side view of the design of FIG. 8;

FIG. 11 is a top view of the design of FIG. 8;

FIG. 12 is a bottom view of the design of FIG. 8;

FIG. 13 is a front view of the design of FIG. 8;

FIG. 14 is a back view of the design of FIG. 8;

FIG. 15 is a perspective view of yet another embodiment of our new design of a dual-sole shoe with stripe, color outpatch sole, and contrasting upper, where the portions of the upper and midsole that contrast with the green outpatch sole are indicated using a slanted line hatching pattern;

FIG. 16 is a first side view of the design of FIG. 15;

FIG. 17 is a second side view of the design of FIG. 15;

FIG. 18 is a top view of the design of FIG. 15;

FIG. 19 is a bottom view of the design of FIG. 15;

FIG. 20 is a front view of the design of FIG. 15;

FIG. 21 is a back view of the design of FIG. 15;

FIG. 22 is a perspective view of yet another embodiment of our new design of a dual-sole shoe with stripe, color outpatch sole, and contrasting upper, where the color portions are indicated using the USPTO convention of solid diagonal lines extending from the upper left to the lower right for green, and where the portions of the upper and midsole that contrast with the outpatch sole are indicated using a crosshatch pattern;

FIG. 23 is a first side view of the design of FIG. 22;

FIG. 24 is a second side view of the design of FIG. 22;

FIG. 25 is a top view of the design of FIG. 22;

FIG. 26 is a bottom view of the design of FIG. 22;

FIG. 27 is a front view of the design of FIG. 22;

FIG. 28 is a back view of the design of FIG. 22;

FIG. 29 is a perspective view of yet another embodiment of our new design of a dual-sole shoe with stripe, color outpatch sole, and contrasting upper, where the portions of the upper and midsole that contrast with the red outpatch sole are indicated using a slanted line hatching pattern;

FIG. 30 is a first side view of the design of FIG. 29;

FIG. 31 is a second side view of the design of FIG. 29;

FIG. 32 is a top view of the design of FIG. 29;

FIG. 33 is a bottom view of the design of FIG. 29;

FIG. 34 is a front view of the design of FIG. 29;

FIG. 35 is a back view of the design of FIG. 29;

FIG. 36 is a perspective view of yet another embodiment of our new design of a dual-sole shoe with stripe, color outpatch sole, and contrasting upper, where the color portions are indicated using the USPTO convention of solid vertical lines for red or pink, and where the portions of the

upper and midsole that contrast with the outpatch sole are indicated using a slanted line hatching pattern;

FIG. 37 is a first side view of the design of FIG. 36;

FIG. 38 is a second side view of the design of FIG. 36;

FIG. 39 is a top view of the design of FIG. 36;

FIG. 40 is a bottom view of the design of FIG. 36;

FIG. 41 is a front view of the design of FIG. 36;

FIG. 42 is a back view of the design of FIG. 36;

FIG. 43 is a perspective view of yet another embodiment of our new design of a dual-sole shoe with stripe, color outpatch sole, and contrasting upper, where the portions of the upper and midsole that contrast with the outpatch blue sole are indicated using a slanted line hatching pattern;

FIG. 44 is a first side view of the design of FIG. 43;

FIG. 45 is a second side view of the design of FIG. 43;

FIG. 46 is a top view of the design of FIG. 43;

FIG. 47 is a bottom view of the design of FIG. 43;

FIG. 48 is a front view of the design of FIG. 43;

FIG. 49 is a back view of the design of FIG. 43;

FIG. 50 is a perspective view of yet another embodiment of our new design of a dual-sole shoe with stripe, color outpatch sole, and contrasting upper, where the color portions are indicated using the USPTO convention of horizontal lines for blue, and where the portions of the upper and midsole that contrast with the outpatch sole are indicated using a slanted line hatching pattern;

FIG. 51 is a first side view of the design of FIG. 50;

FIG. 52 is a second side view of the design of FIG. 50;

FIG. 53 is a top view of the design of FIG. 50;

FIG. 54 is a bottom view of the design of FIG. 50;

FIG. 55 is a front view of the design of FIG. 50;

FIG. 56 is a back view of the design of FIG. 50;

FIG. 57 is a perspective view of yet another embodiment of our new design of a dual-sole shoe with stripe, color outpatch sole, and contrasting upper, where the color portions are indicated using a cross-hatched pattern to indicate the blue color Pantone 7466C, and where the portions of the upper and midsole that contrast with the outpatch sole are indicated using a slanted line hatching pattern;

FIG. 58 is a first side view of the design of FIG. 57;

FIG. 59 is a second side view of the design of FIG. 57;

FIG. 60 is a top view of the design of FIG. 57;

FIG. 61 is a bottom view of the design of FIG. 57;

FIG. 62 is a front view of the design of FIG. 57;

FIG. 63 is a back view of the design of FIG. 57;

FIG. 64 is a perspective view of yet another embodiment of our new design of a dual-sole shoe with stripe, color outpatch sole, and contrasting upper, where the portions of the upper and midsole that contrast with the orange outpatch sole are indicated using a slanted line hatching pattern;

FIG. 65 is a first side view of the design of FIG. 64;

FIG. 66 is a second side view of the design of FIG. 64;

FIG. 67 is a top view of the design of FIG. 64;

FIG. 68 is a bottom view of the design of FIG. 64;

FIG. 69 is a front view of the design of FIG. 64;

FIG. 70 is a back view of the design of FIG. 64;

FIG. 71 is a perspective view of yet another embodiment of our new design of a dual-sole shoe with stripe, color outpatch sole, and contrasting upper, where the color portions are indicated using the USPTO convention of diagonal cross-hatched lines for orange, and where the portions of the upper and midsole that contrast with the outpatch sole are indicated using a slanted line hatching pattern;

FIG. 72 is a first side view of the design of FIG. 71;

FIG. 73 is a second side view of the design of FIG. 71;

FIG. 74 is a top view of the design of FIG. 71;
FIG. 75 is a bottom view of the design of FIG. 71;
FIG. 76 is a front view of the design of FIG. 71;
FIG. 77 is a back view of the design of FIG. 71;
FIG. 78 is a perspective view of yet another embodiment of our new design of a dual-sole shoe with stripe, color outpatch sole, and contrasting upper, where the portions of the upper and midsole that contrast with the yellow outpatch sole are indicated using a slanted line hatching pattern;
FIG. 79 is a first side view of the design of FIG. 78;
FIG. 80 is a second side view of the design of FIG. 78;
FIG. 81 is a top view of the design of FIG. 78;
FIG. 82 is a bottom view of the design of FIG. 78;
FIG. 83 is a front view of the design of FIG. 78;
FIG. 84 is a back view of the design of FIG. 78;
FIG. 85 is a perspective view of yet another embodiment of our new design of a dual-sole shoe with stripe, color outpatch sole, and contrasting upper, where the color portions are indicated using the USPTO convention of vertical and horizontal cross-hatched lines for yellow or gold, and where the portions of the upper and midsole that contrast with the outpatch sole are indicated using a slanted line hatching pattern;

FIG. 86 is a first side view of the design of FIG. 85;
FIG. 87 is a second side view of the design of FIG. 85;
FIG. 88 is a top view of the design of FIG. 85;
FIG. 89 is a bottom view of the design of FIG. 85;
FIG. 90 is a front view of the design of FIG. 85;
FIG. 91 is a back view of the design of FIG. 85; and
FIG. 92 is a perspective view of yet another embodiment of our new design of a dual-sole shoe with stripe, color outpatch sole, and contrasting upper, where the portions of the upper and midsole that contrast with the outpatch sole are indicated using a slanted line hatching pattern;
FIG. 93 is a first side view of the design of FIG. 92;
FIG. 94 is a second side view of the design of FIG. 92;
FIG. 95 is a top view of the design of FIG. 92;
FIG. 96 is a bottom view of the design of FIG. 92;
FIG. 97 is a front view of the design of FIG. 92; and,
FIG. 98 is a back view of the design of FIG. 92.
The broken lines illustrating the half moon patch and the groove in the above described Figures are understood to be unclaimed subject matter.

**1 Claim, 84 Drawing Sheets
(30 of 84 Drawing Sheet(s) Filed in Color)**

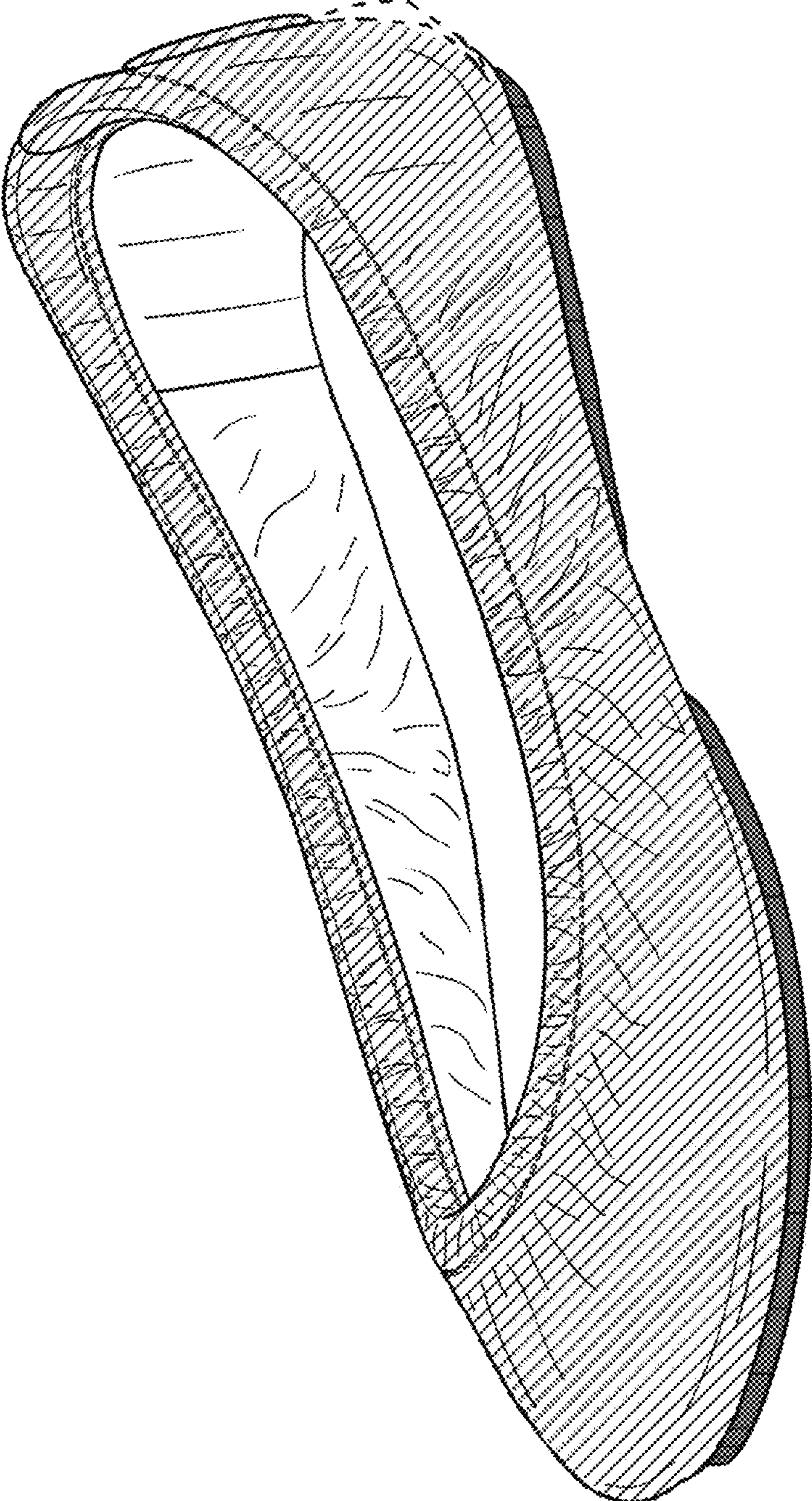

FIG. 1

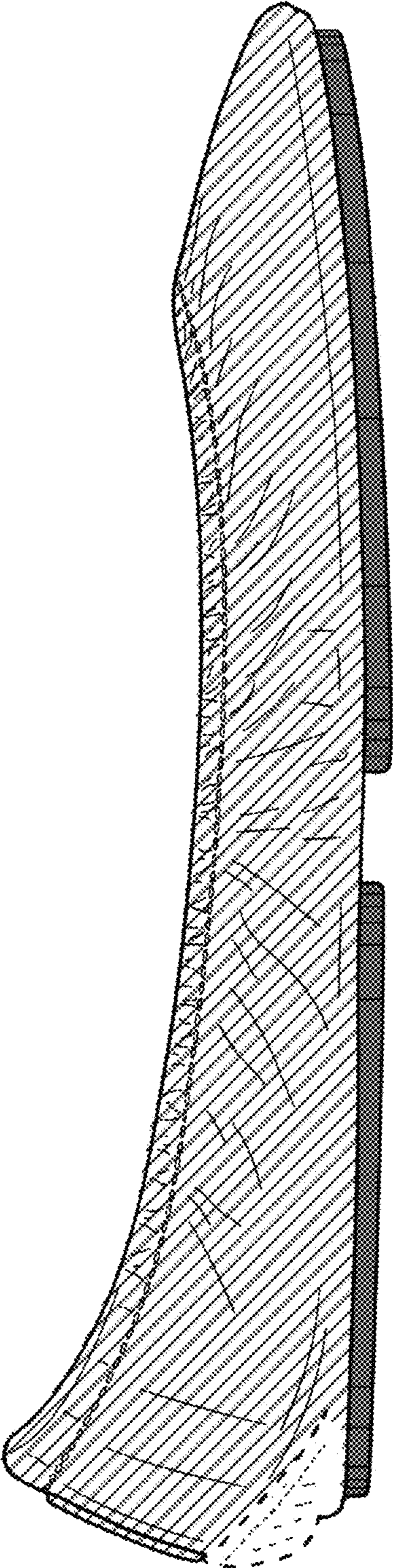

FIG. 2

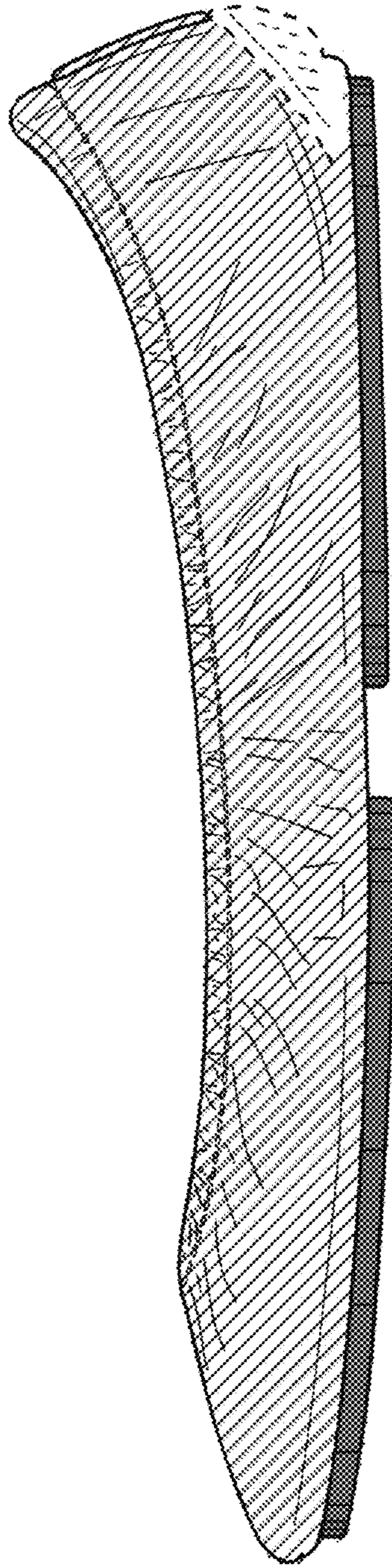

FIG. 3

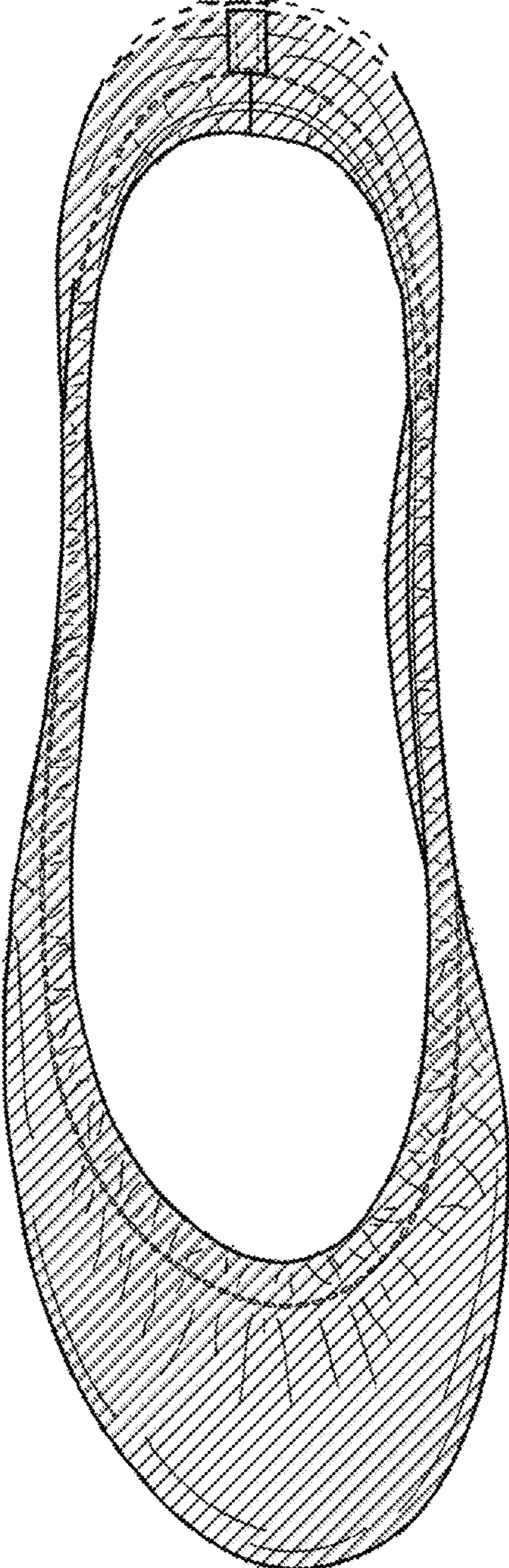

FIG. 4

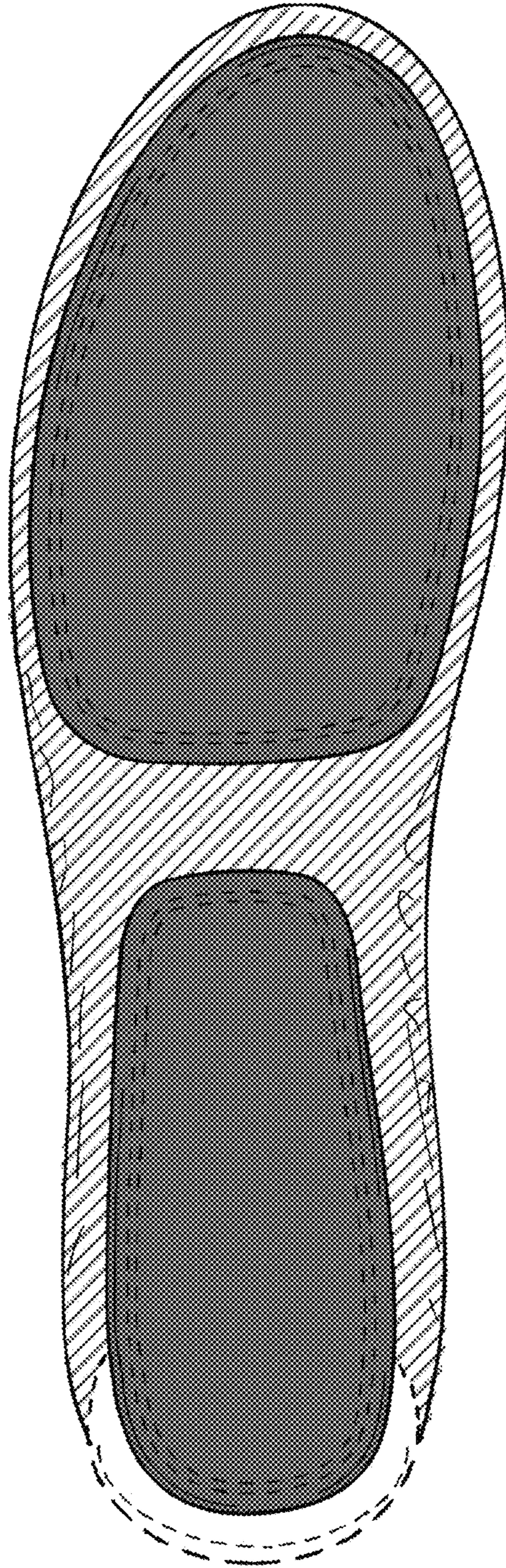

FIG. 5

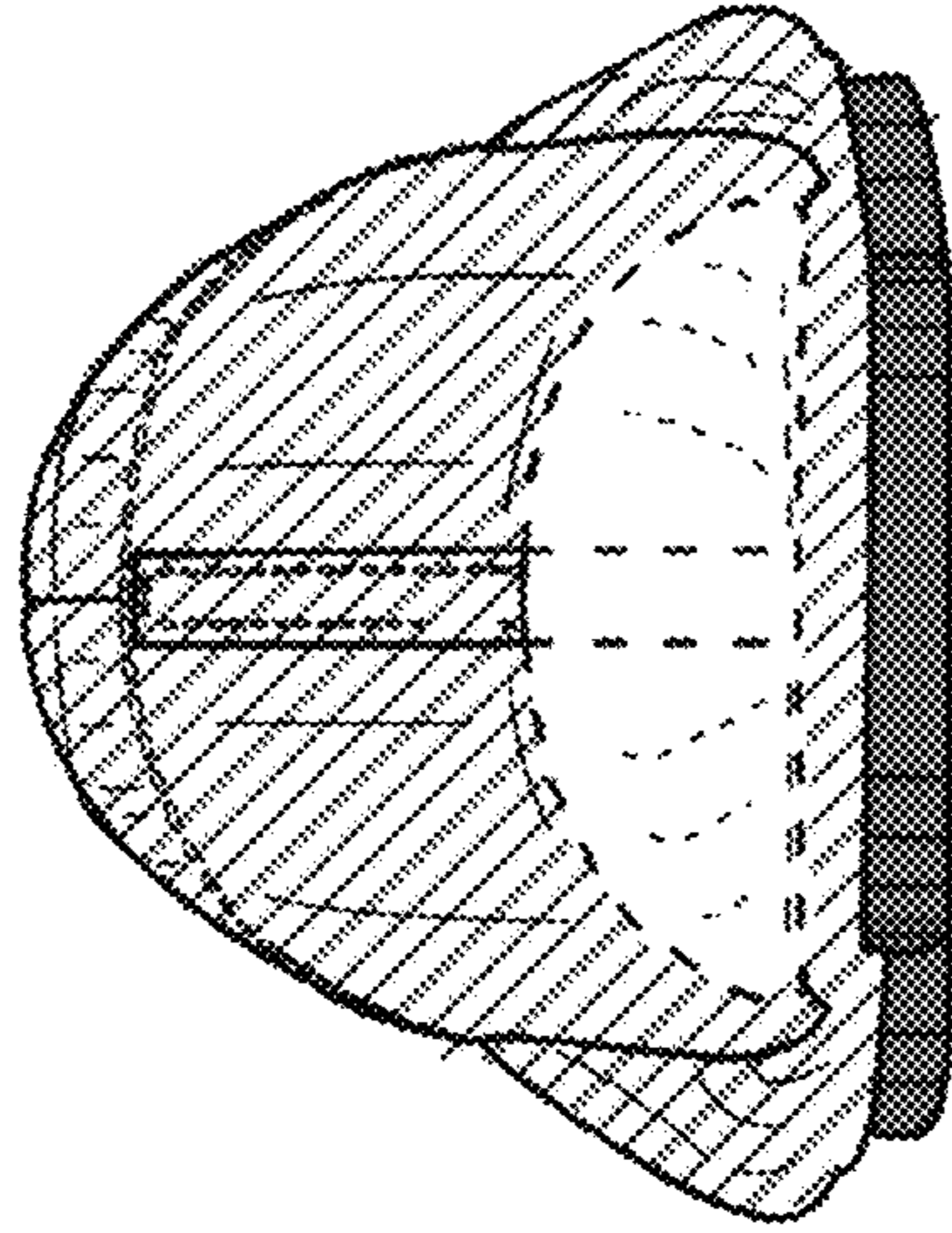

FIG. 6

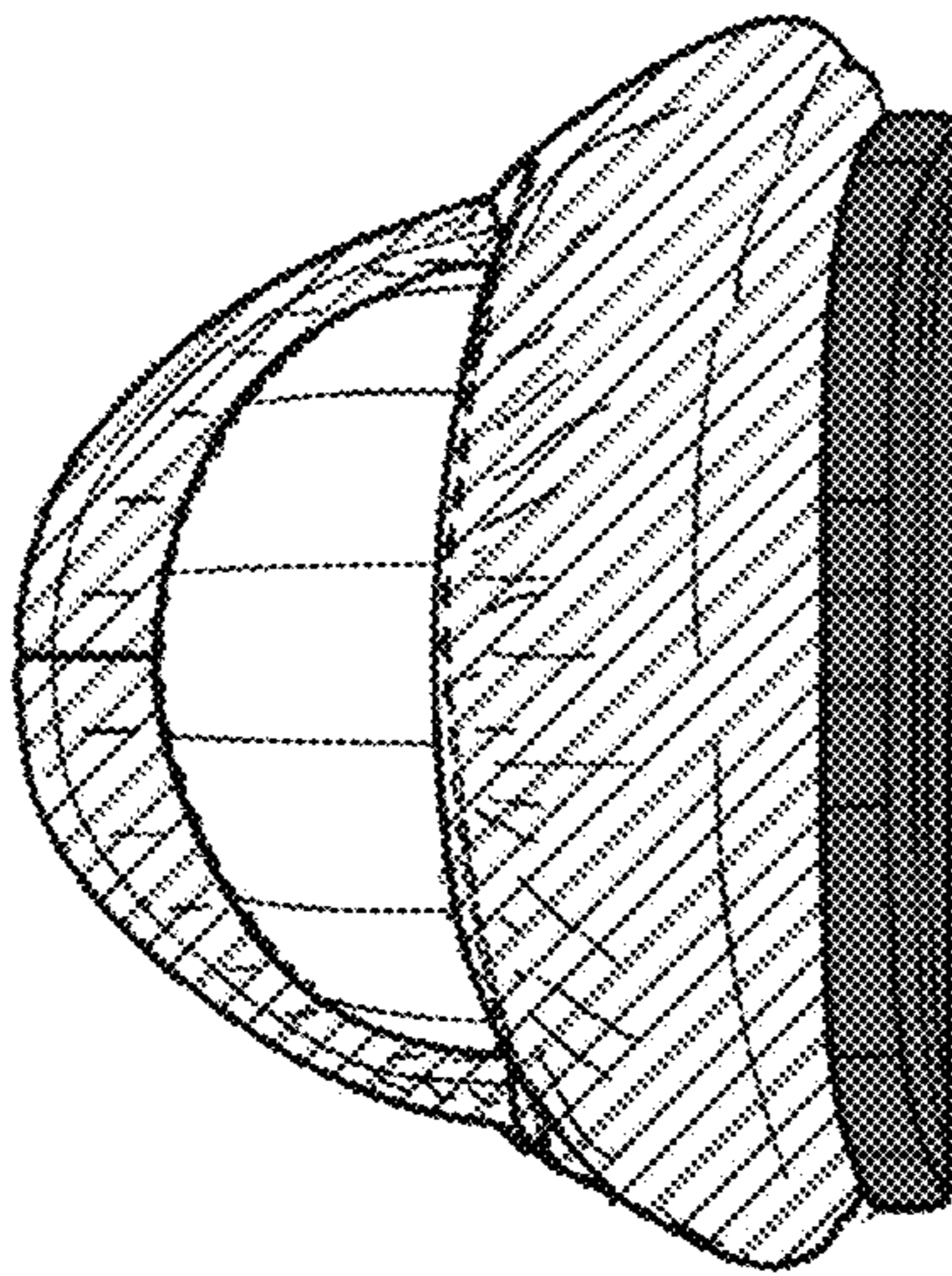

FIG. 7

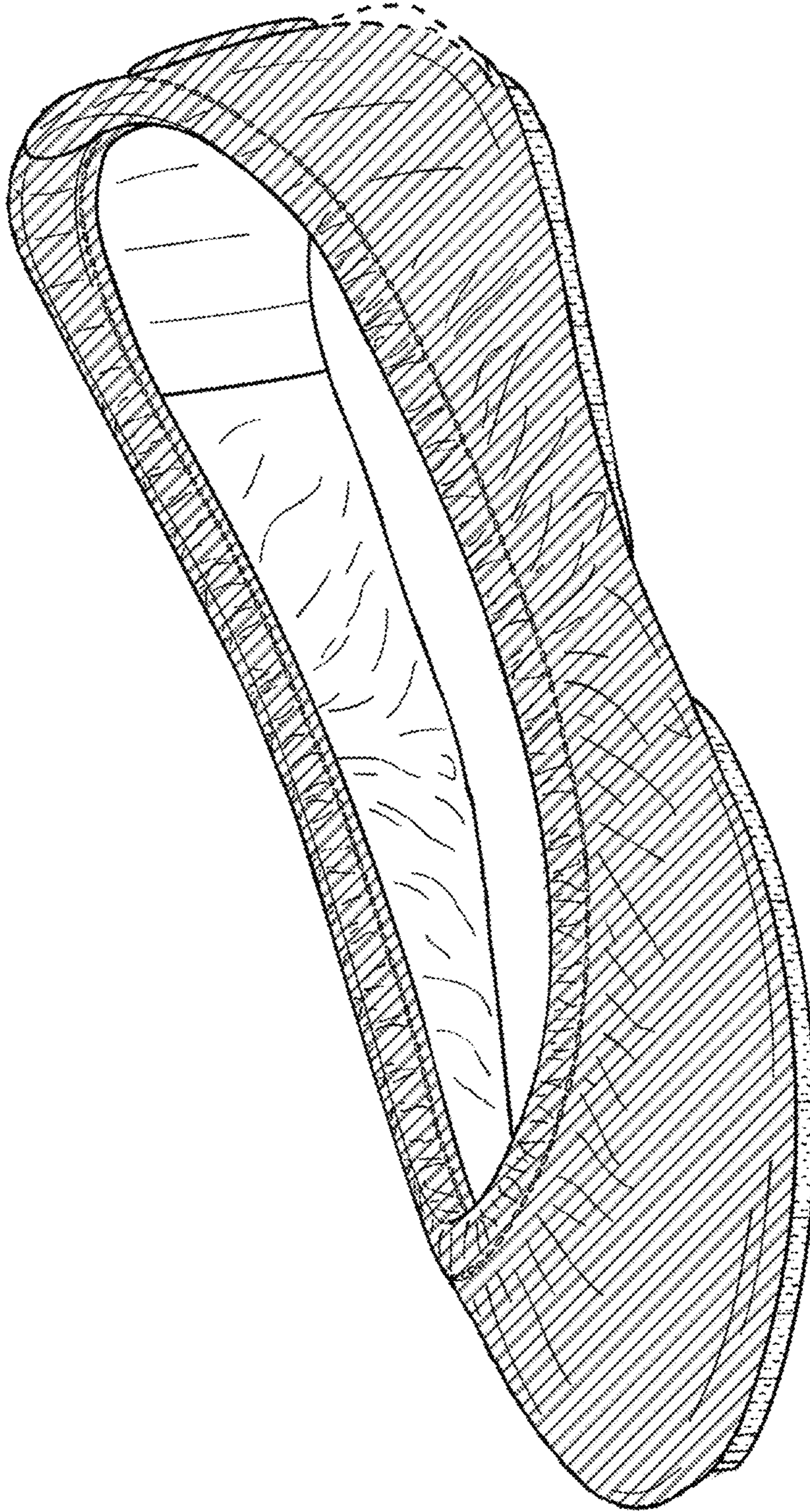

FIG. 8

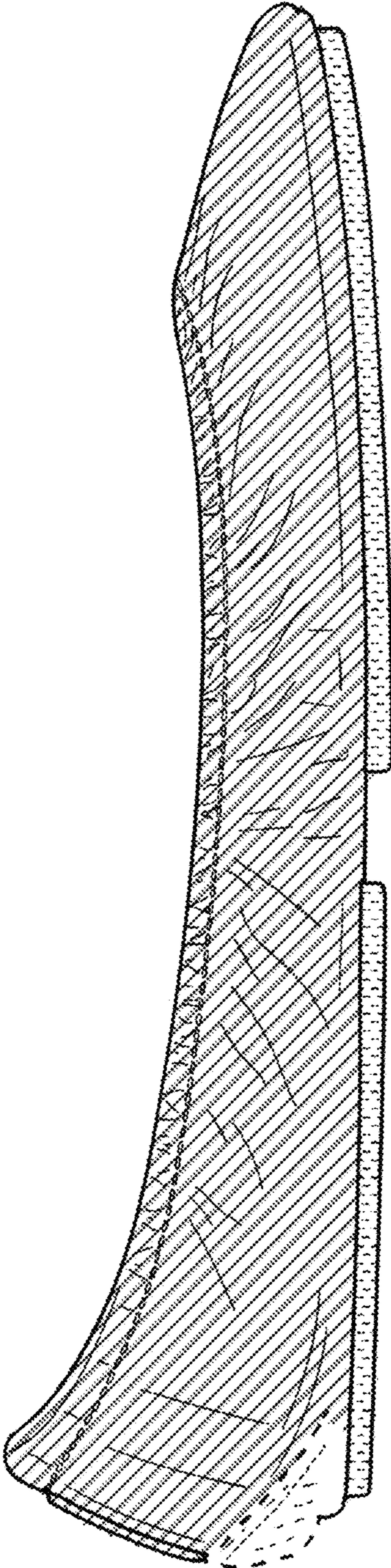

FIG. 9

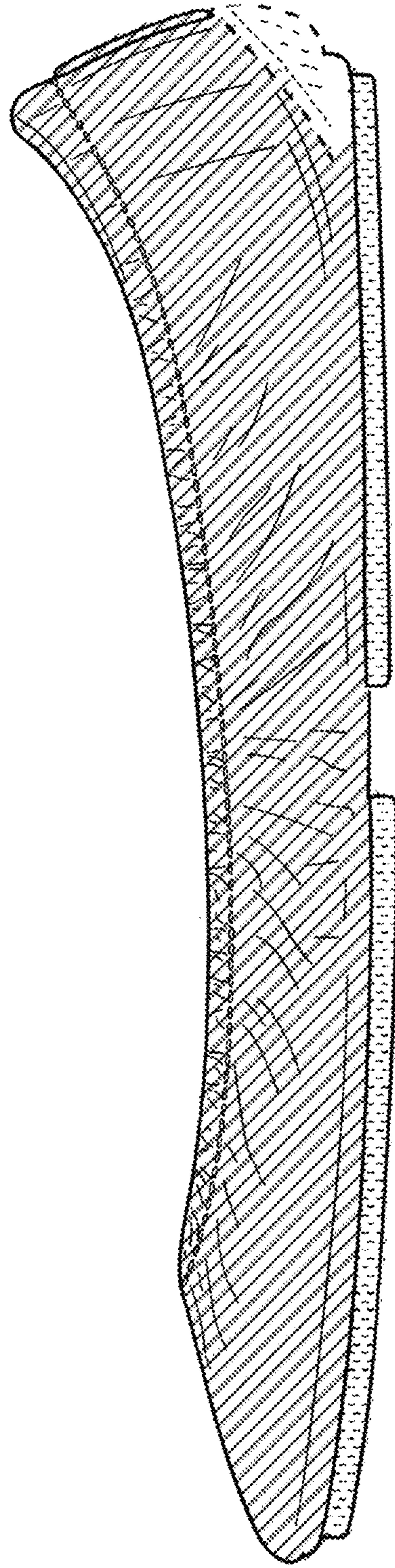

FIG. 10

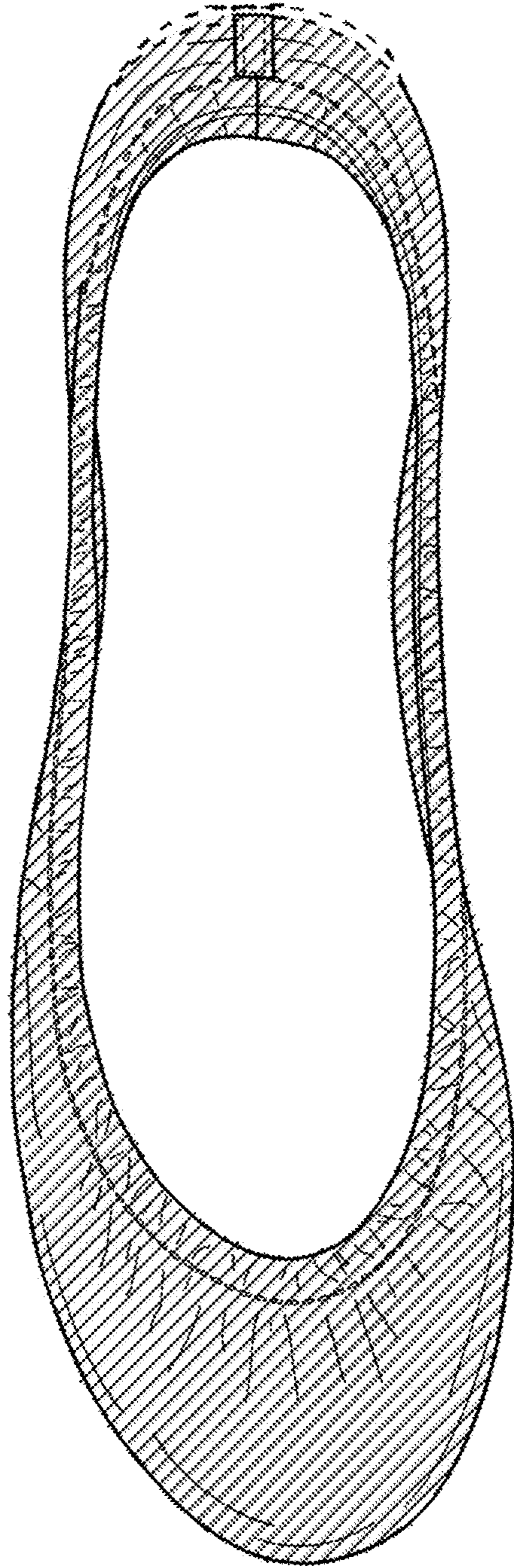

FIG. 11

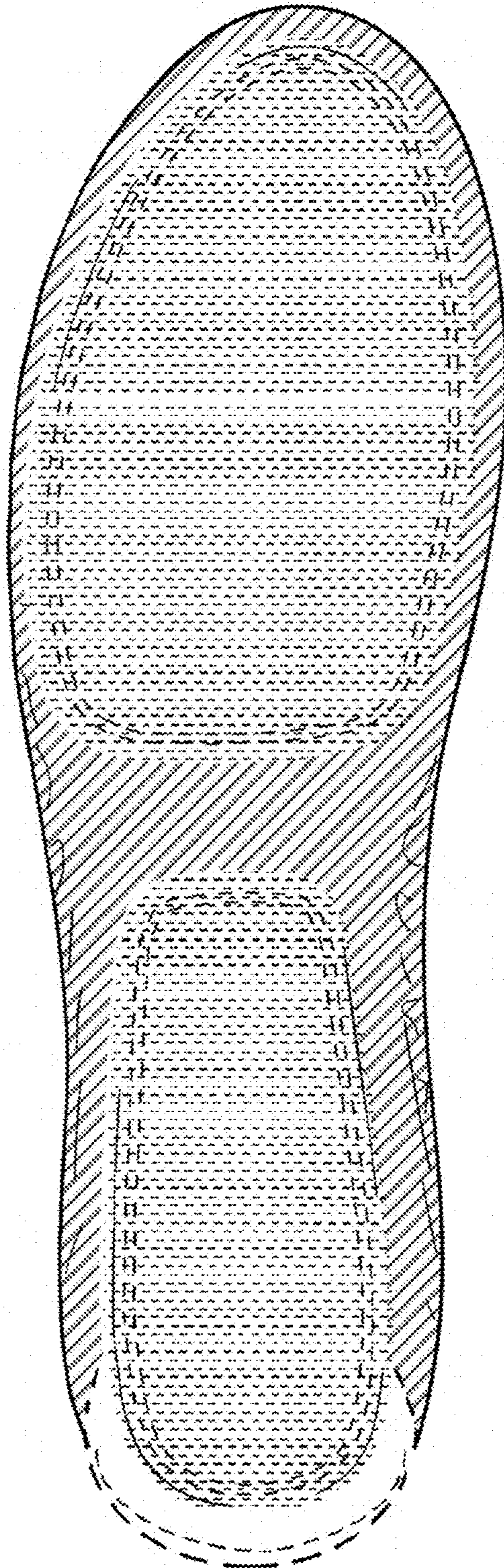

FIG. 12

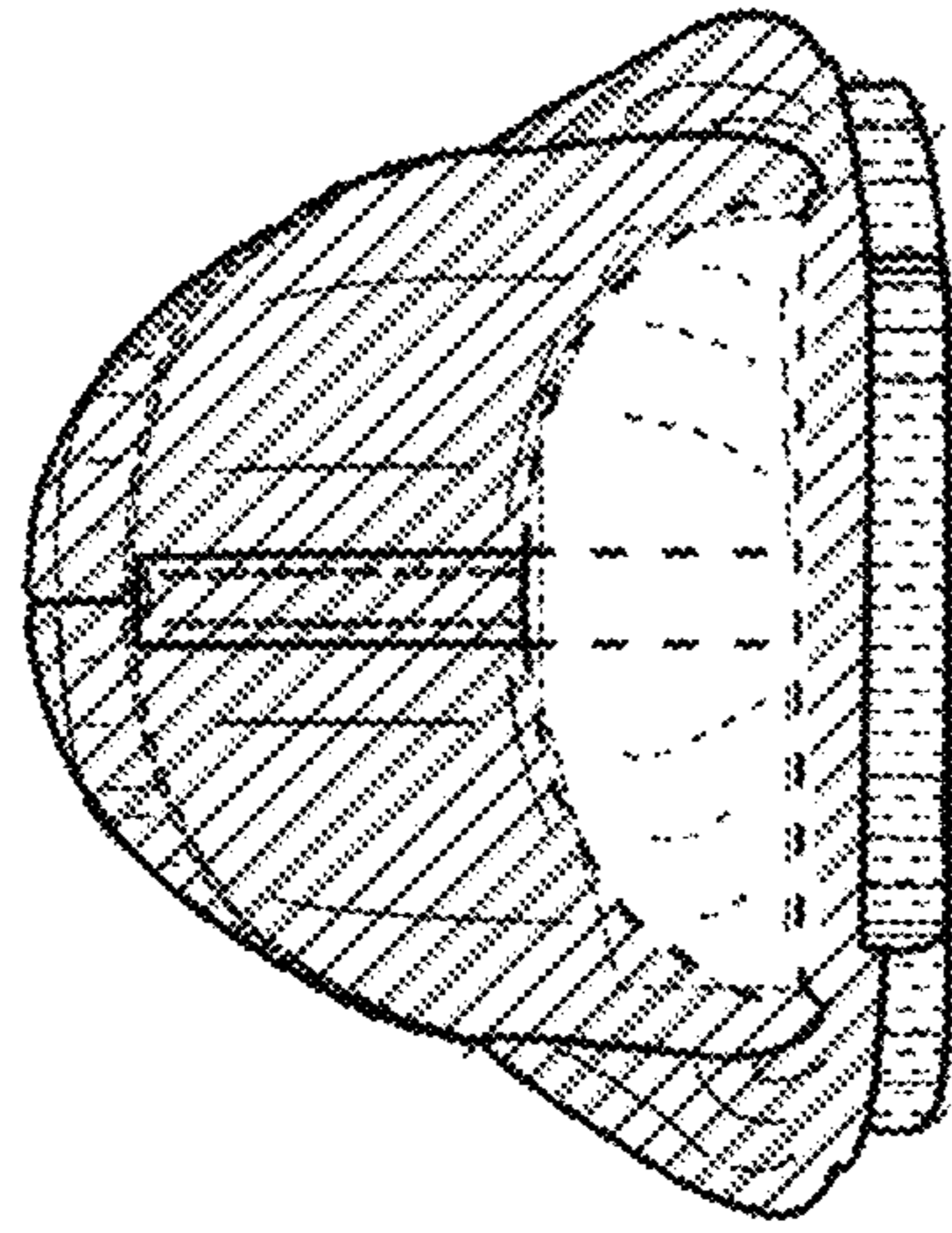

FIG. 13

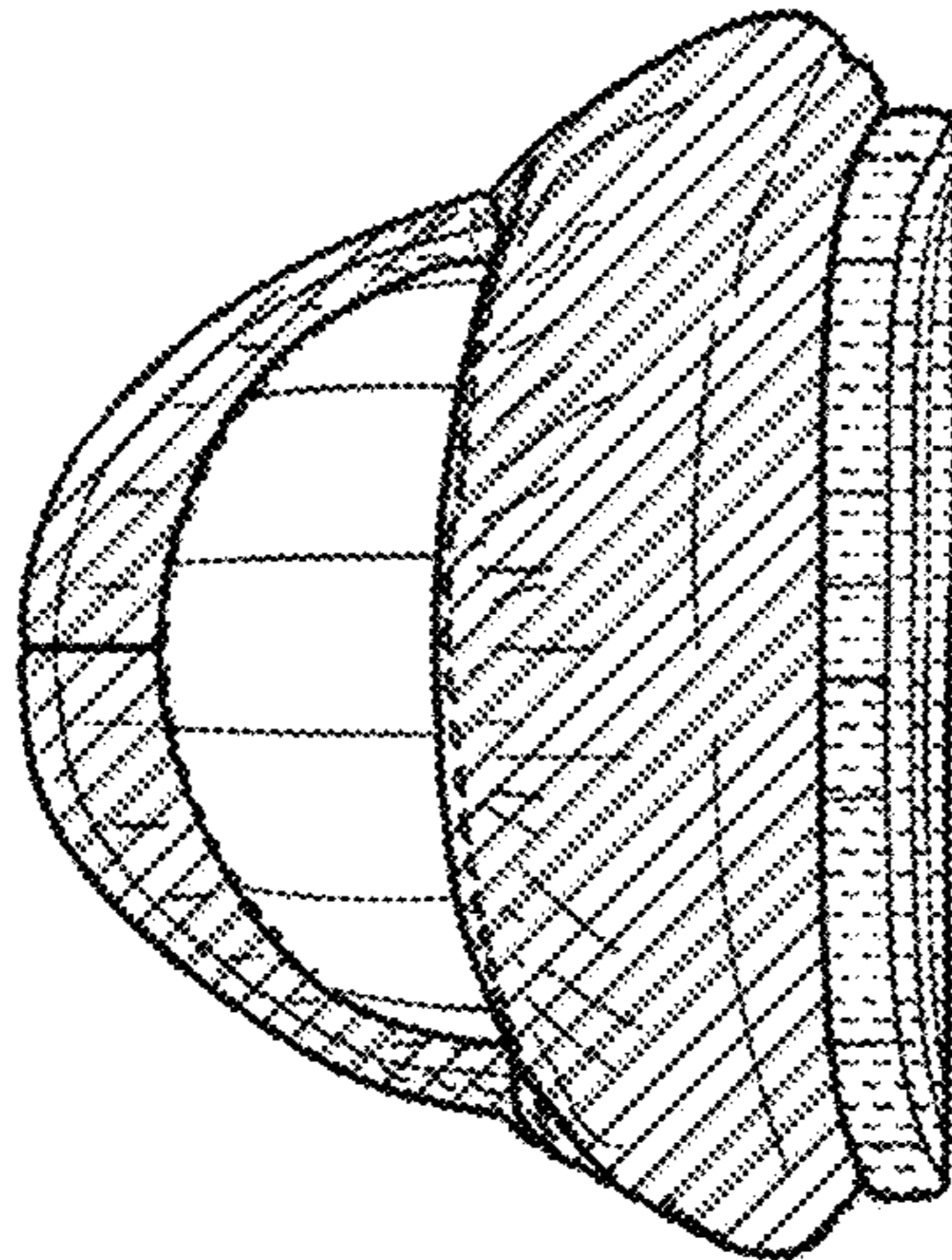

FIG. 14

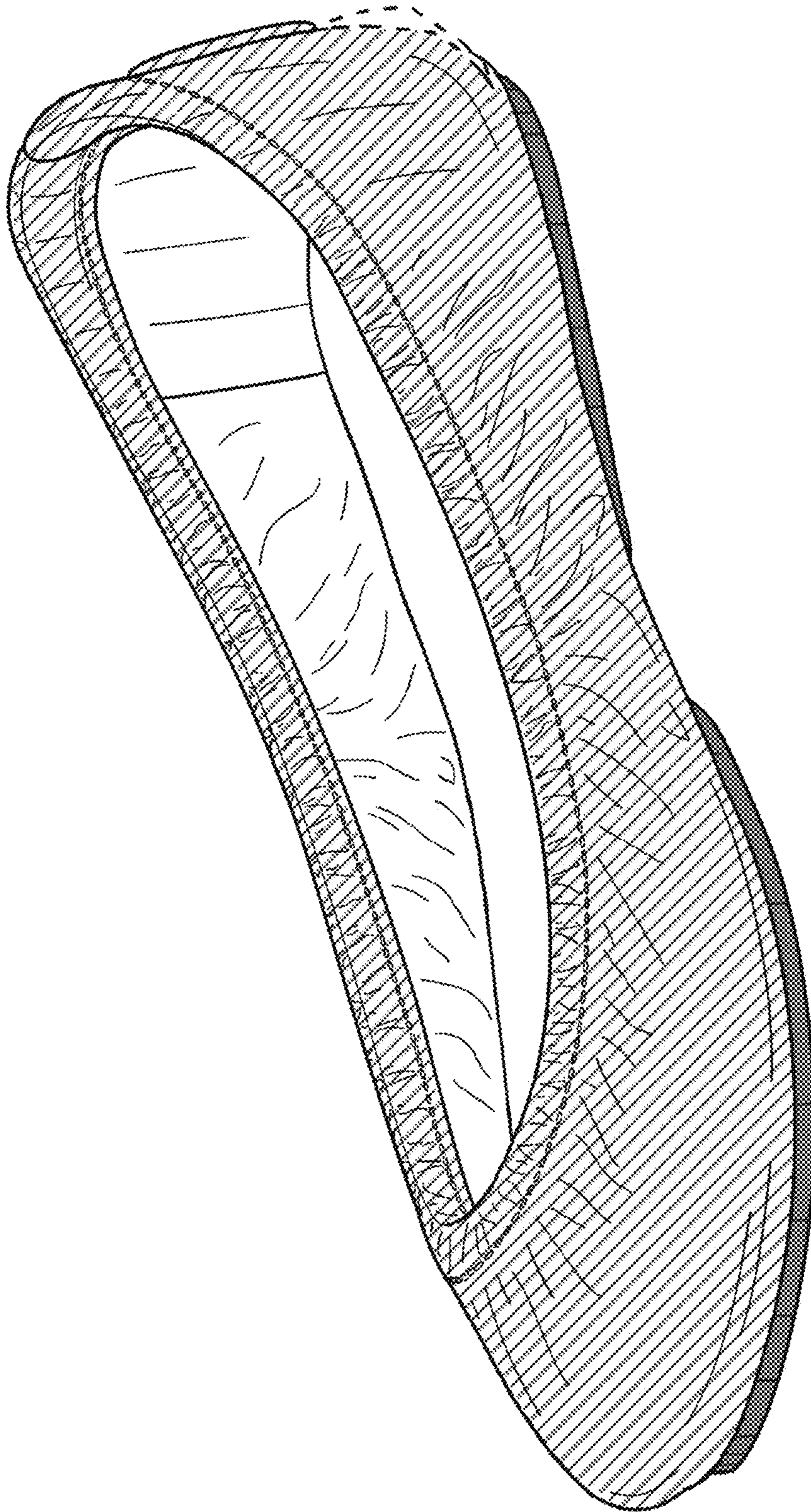

FIG. 15

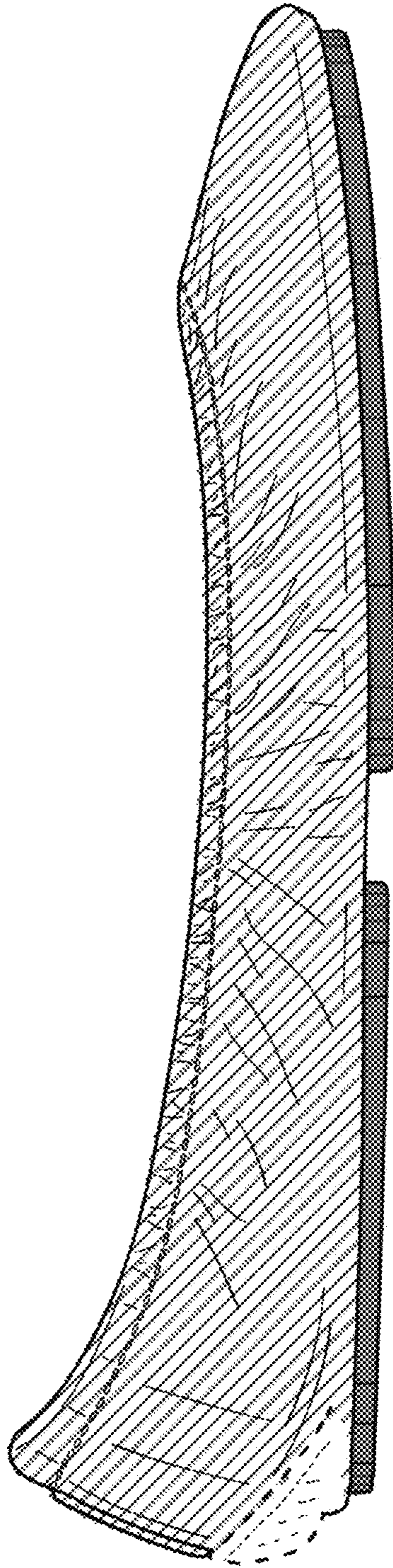

FIG. 16

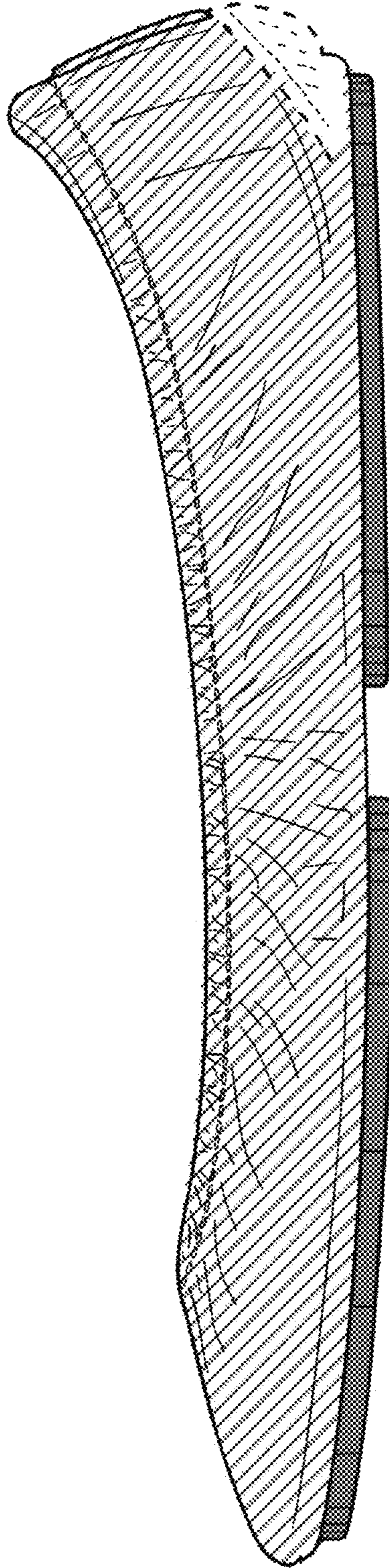

FIG. 17

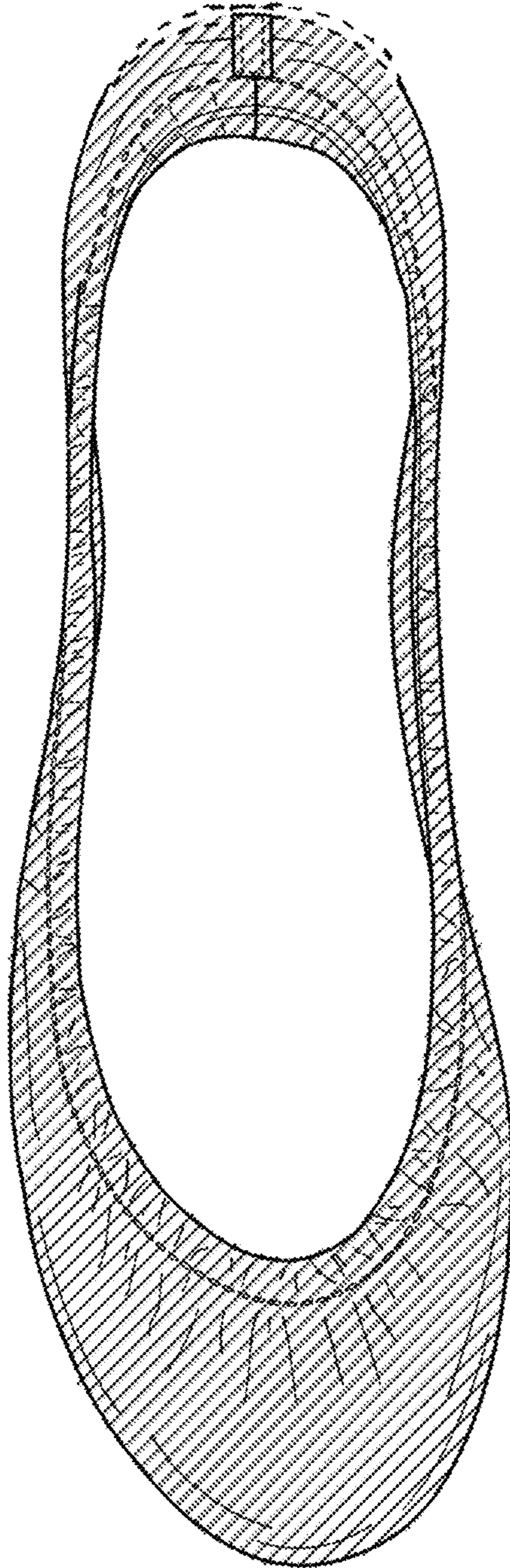

FIG. 18

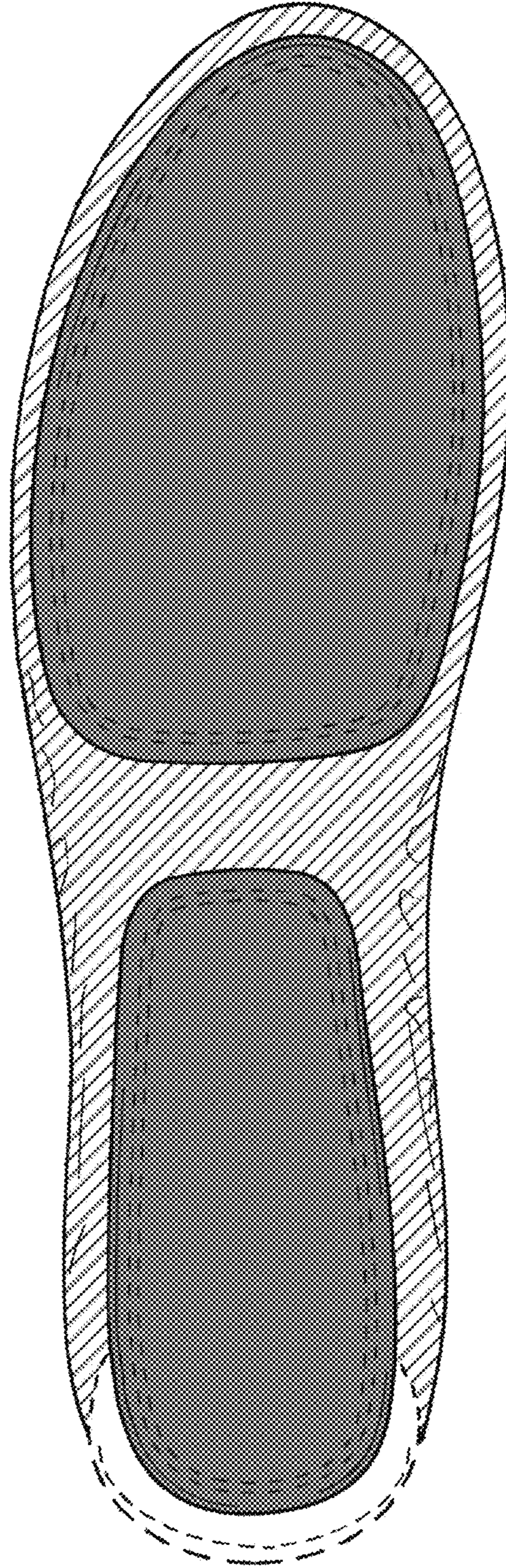

FIG. 19

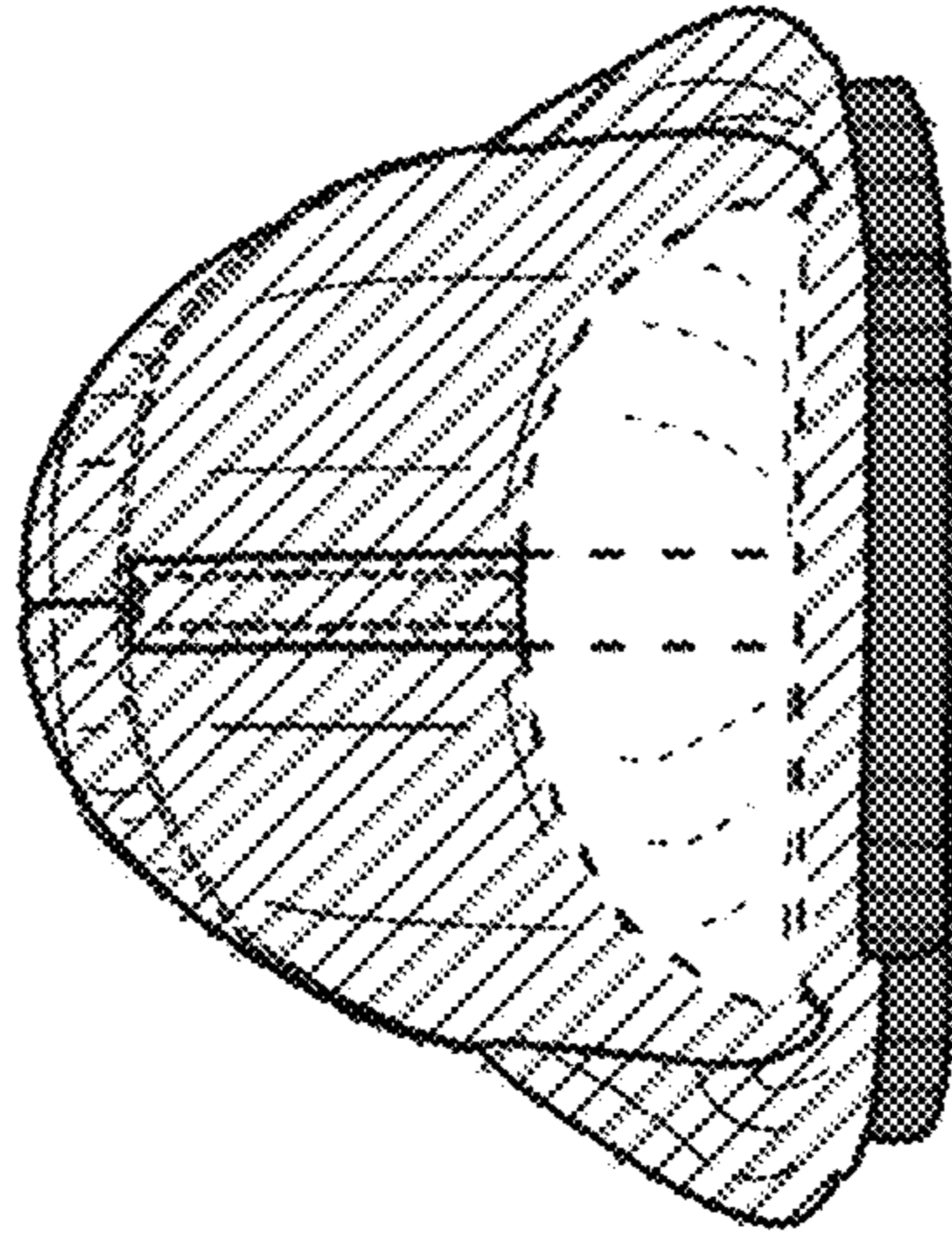

FIG. 21

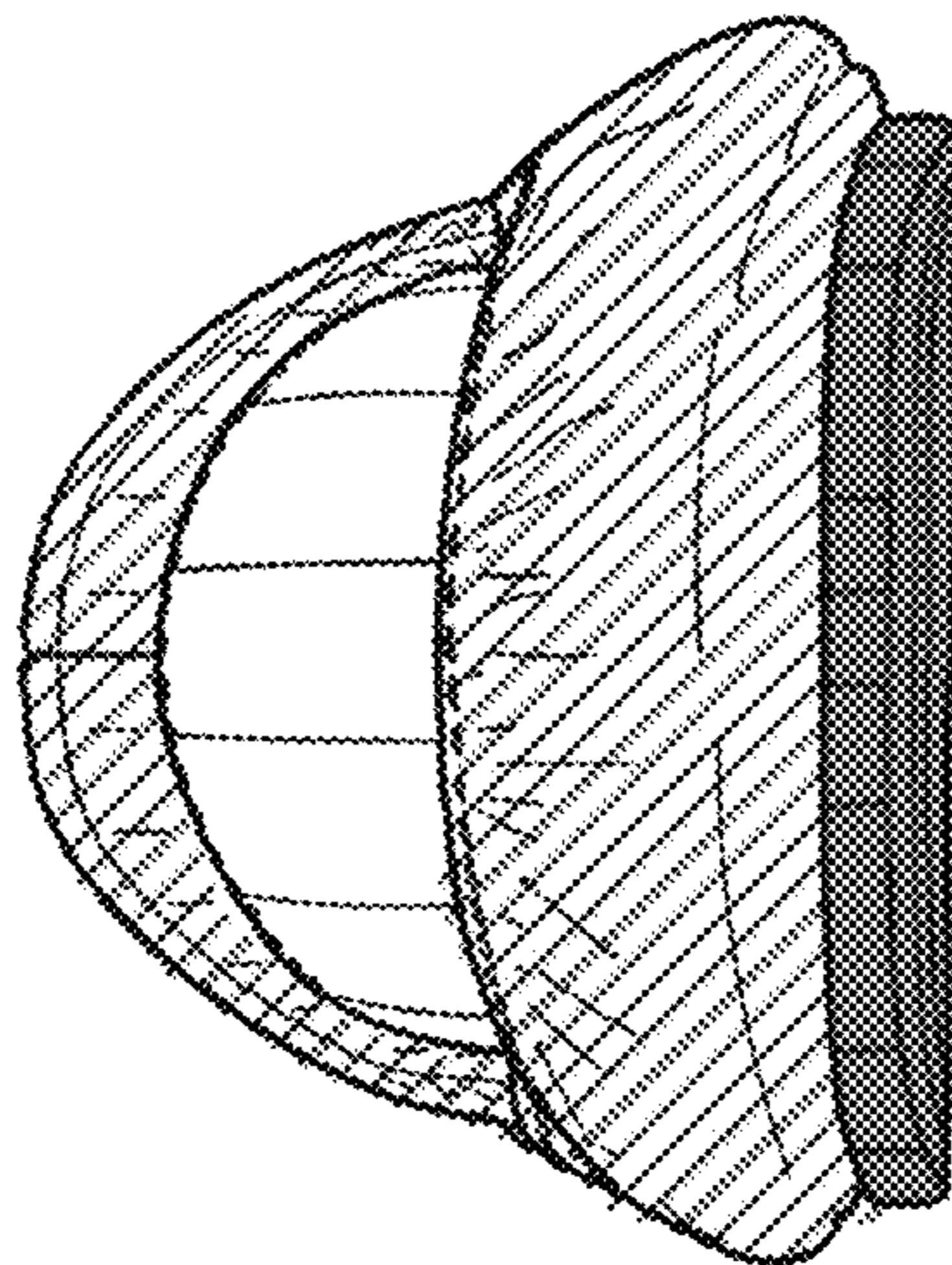

FIG. 20

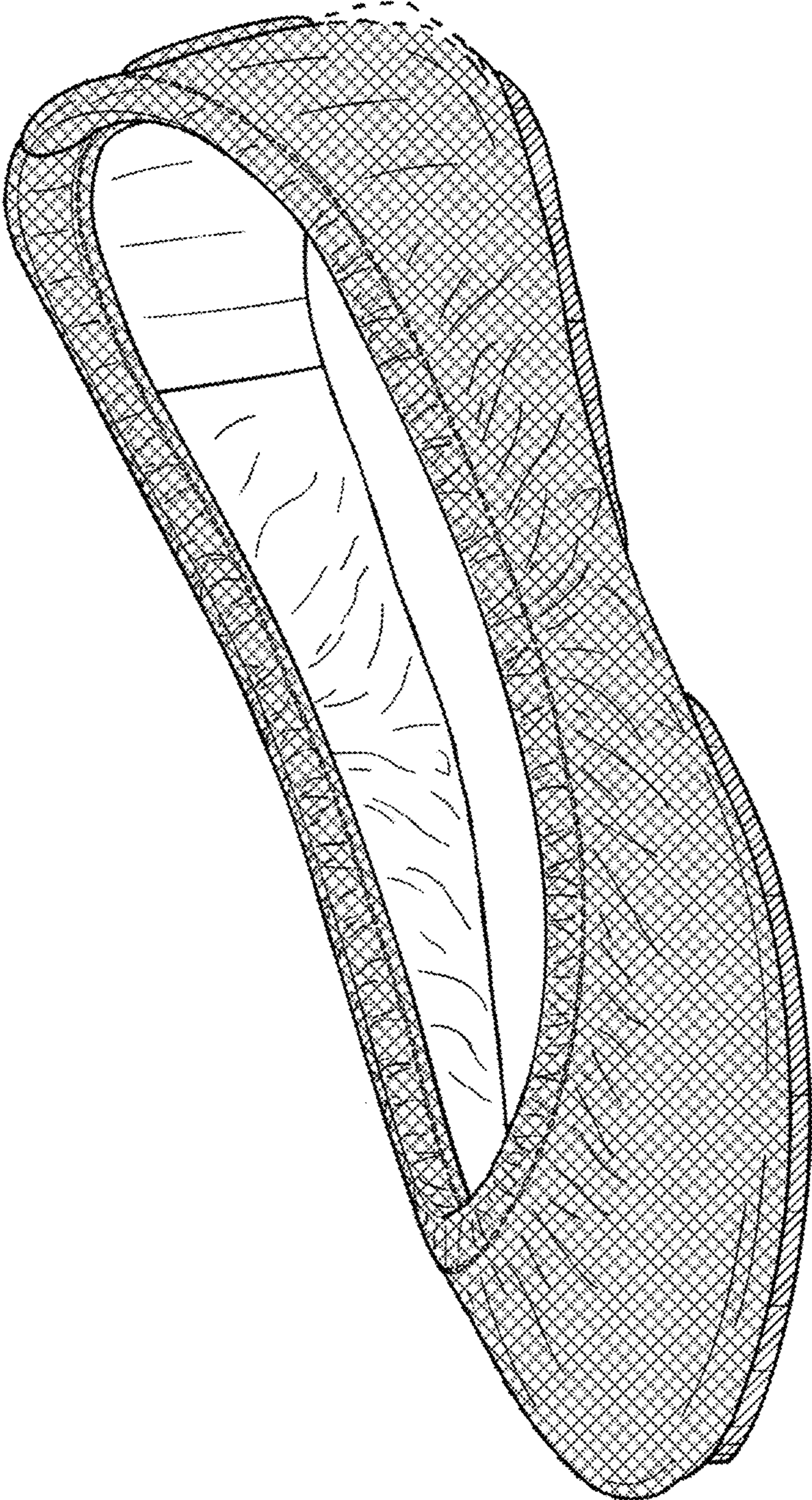

FIG. 22

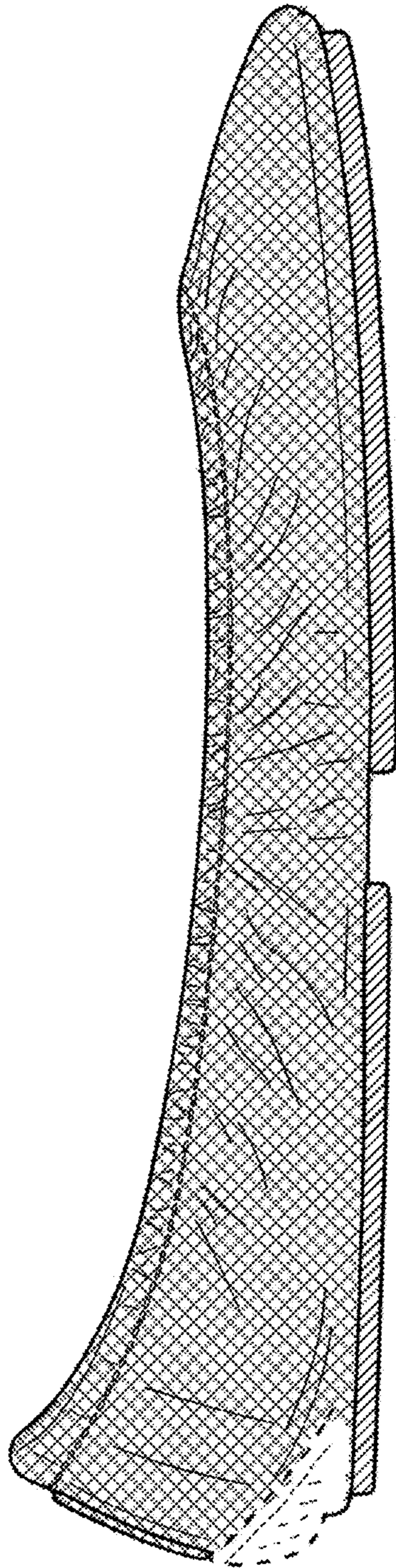

FIG. 23

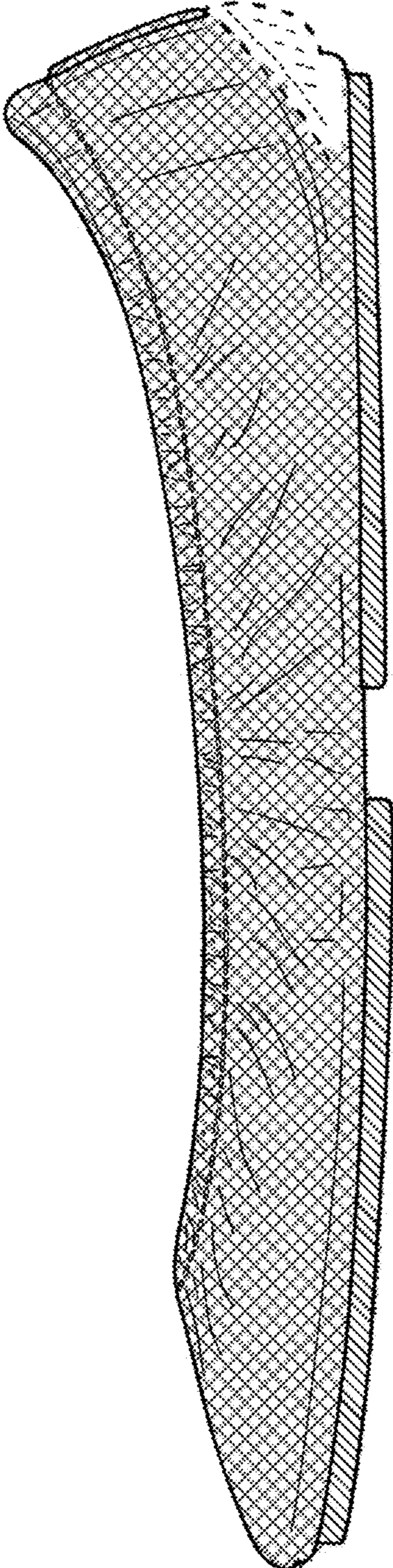

FIG. 24

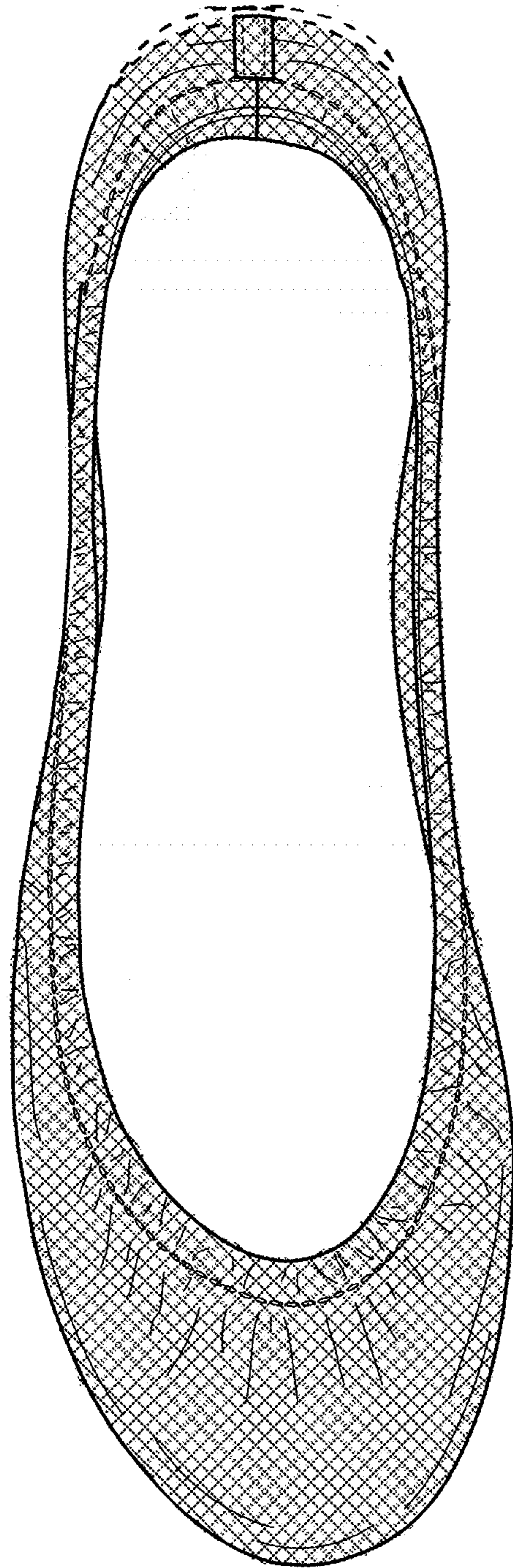

FIG. 25

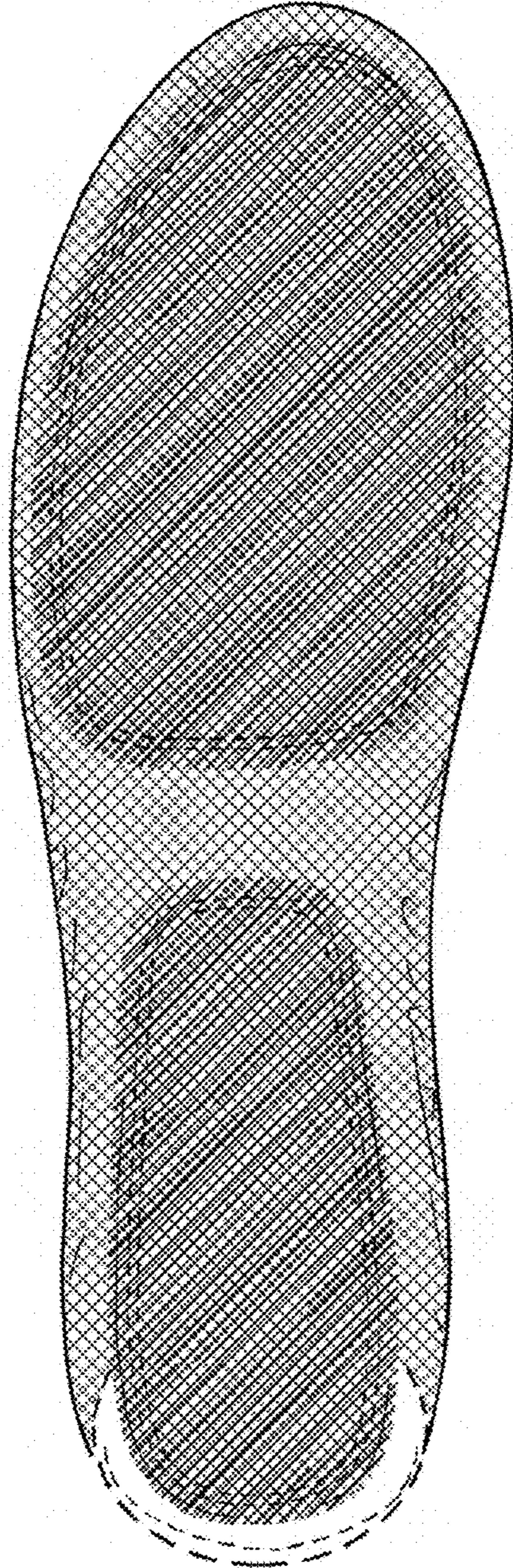

FIG. 26

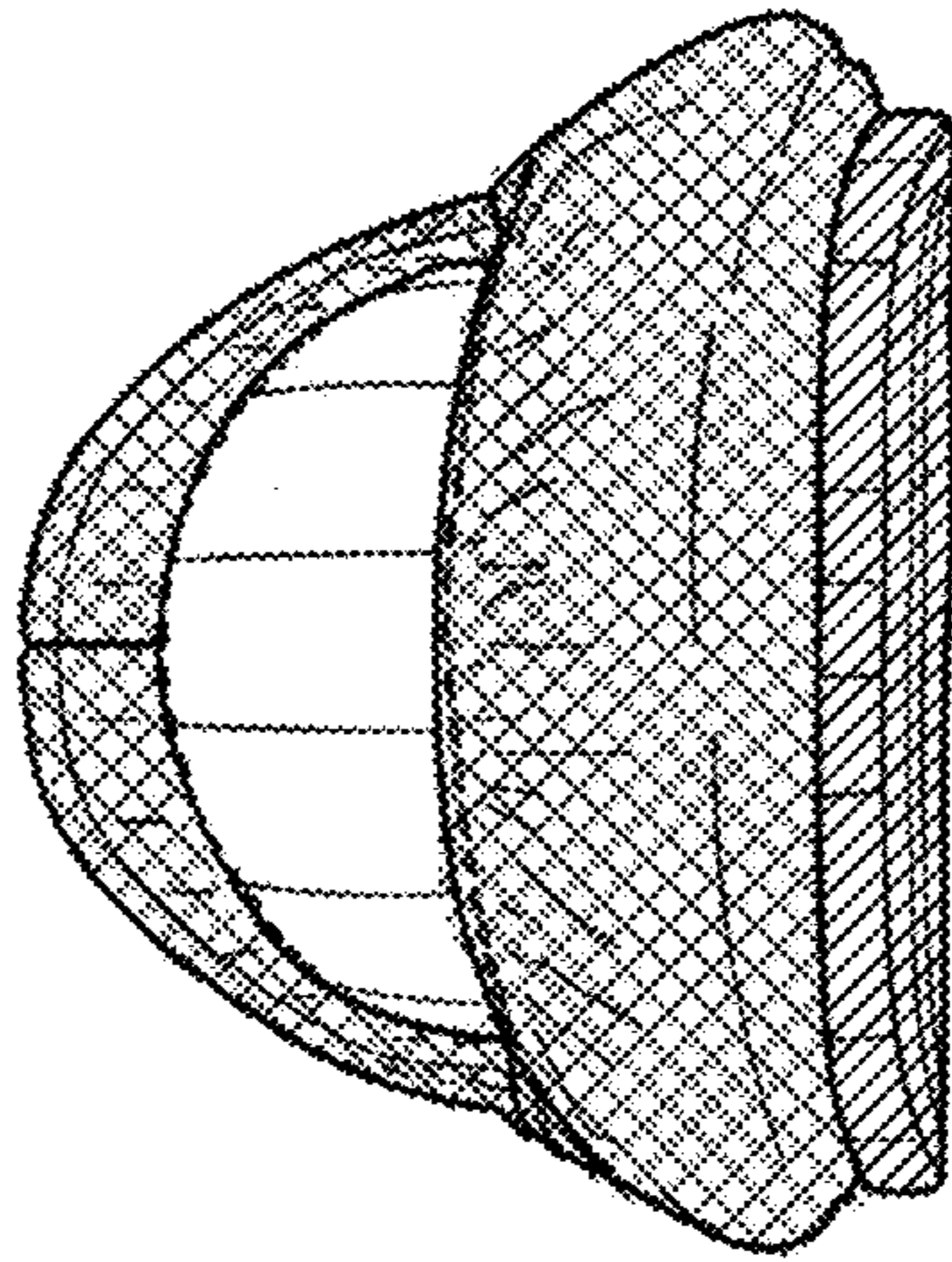

FIG. 27

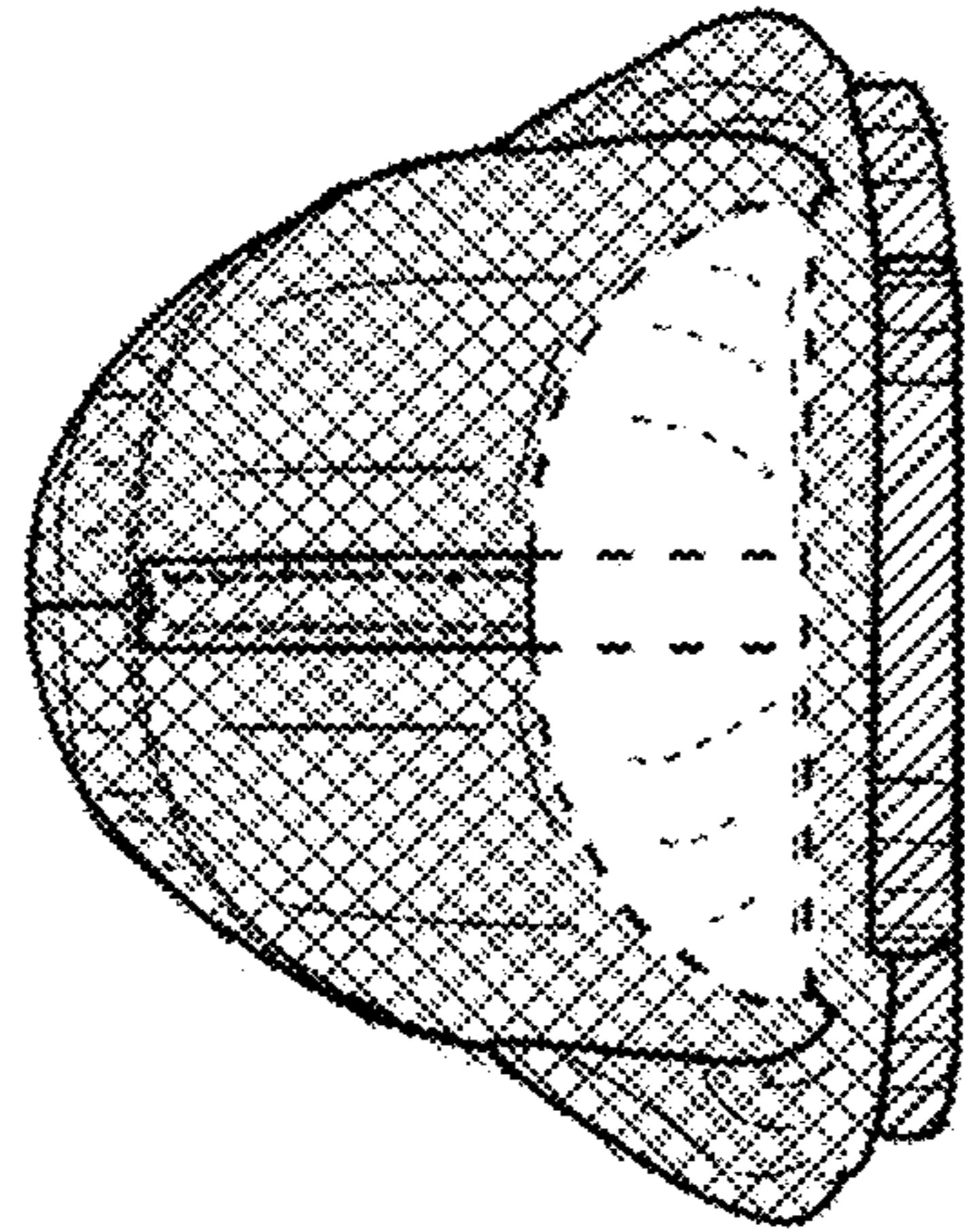

FIG. 28

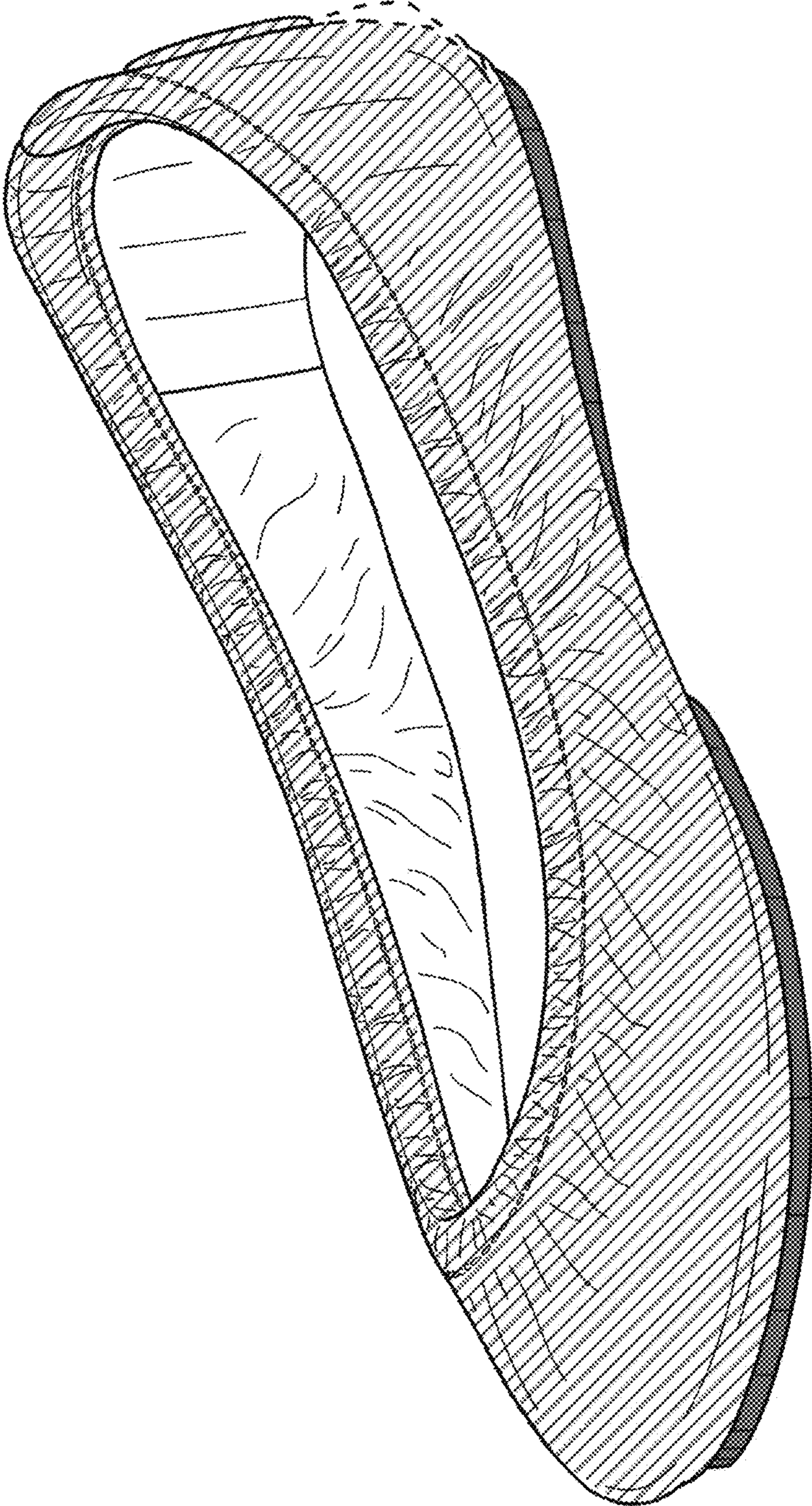

FIG. 29

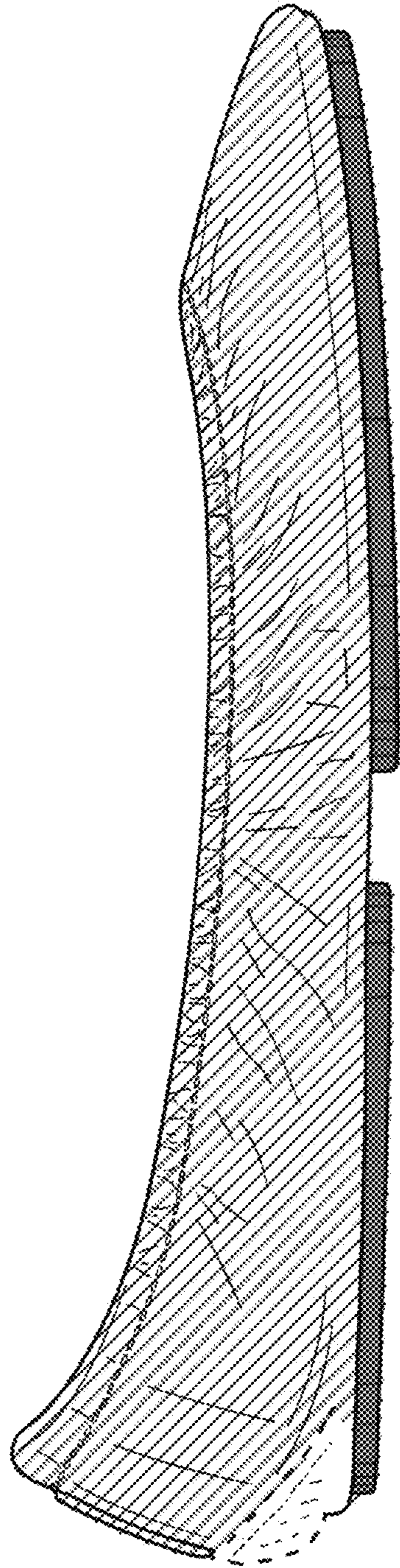

FIG. 30

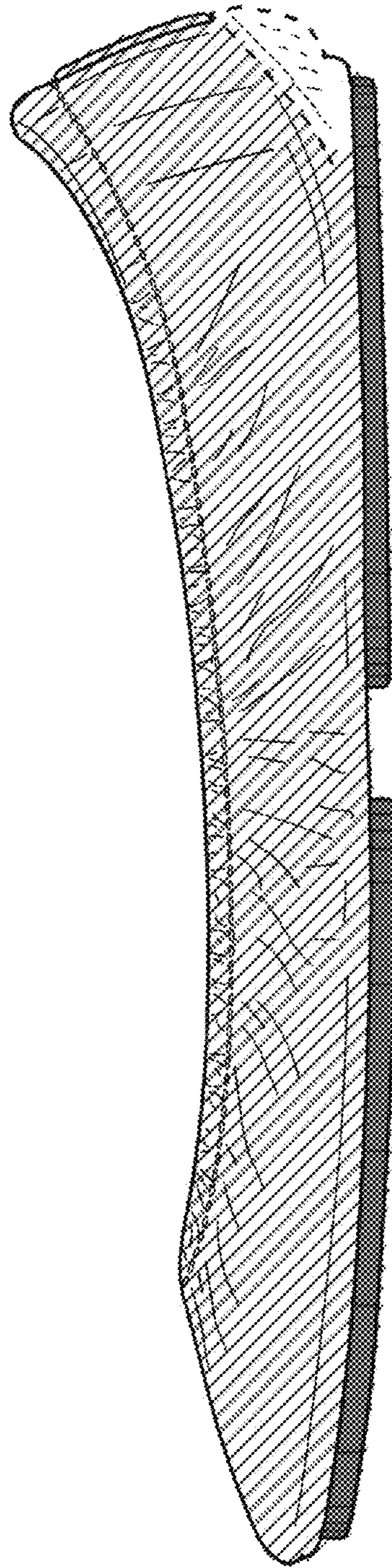

FIG. 31

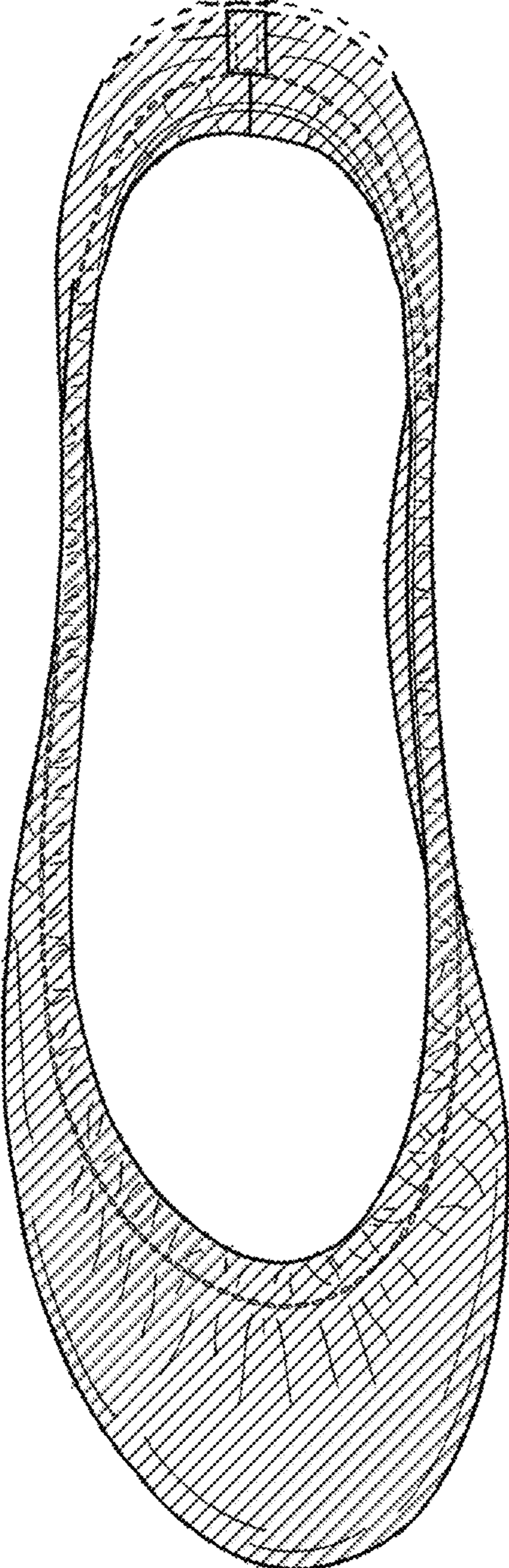

FIG. 32

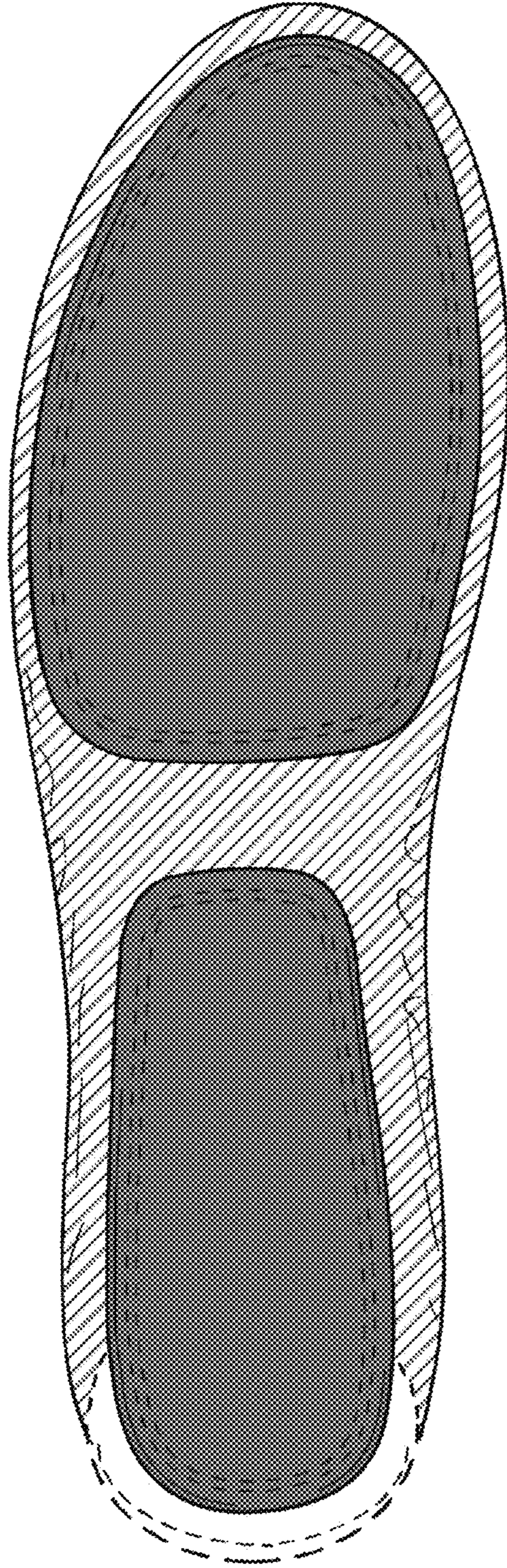

FIG. 33

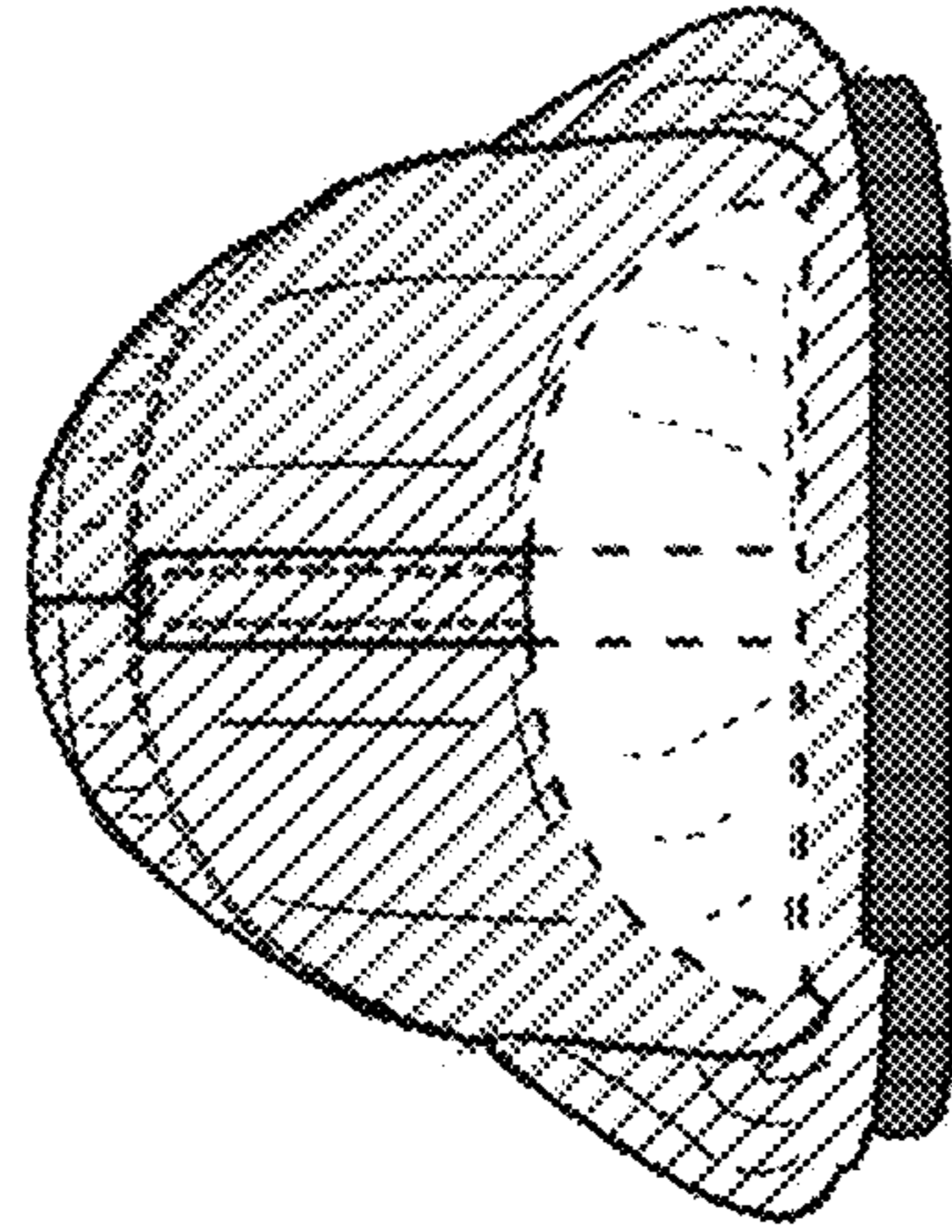

FIG. 34

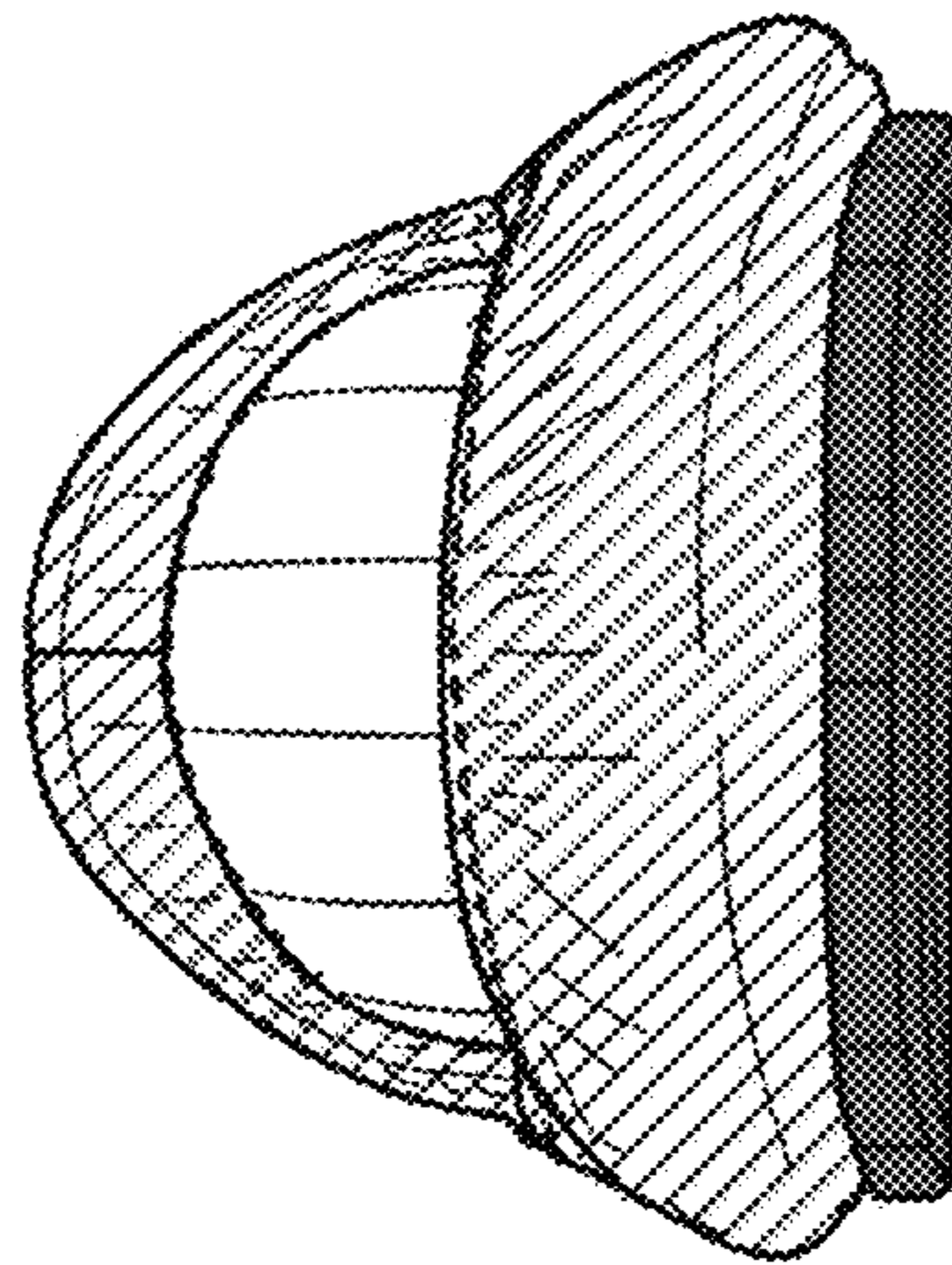

FIG. 35

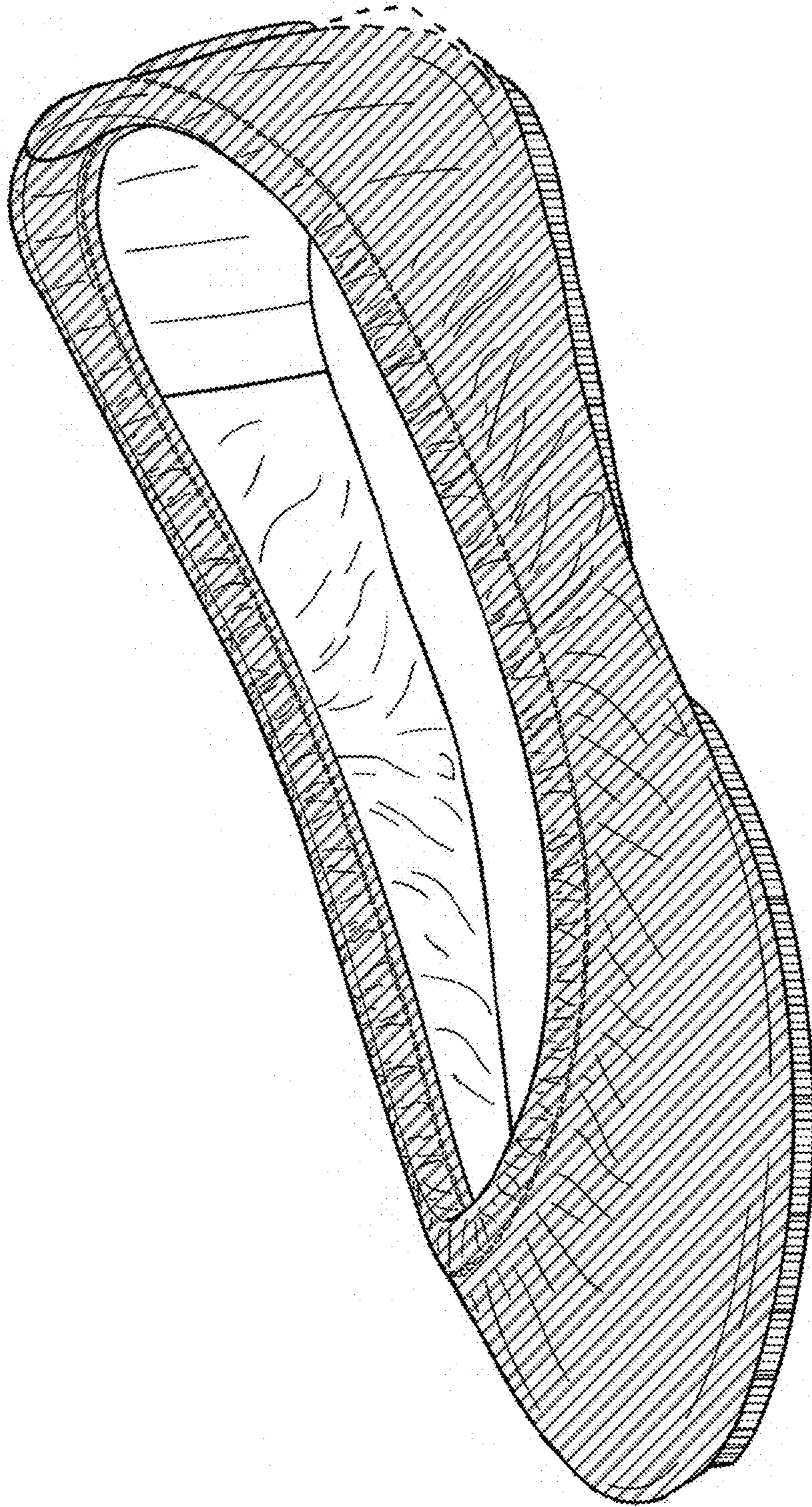

FIG. 36

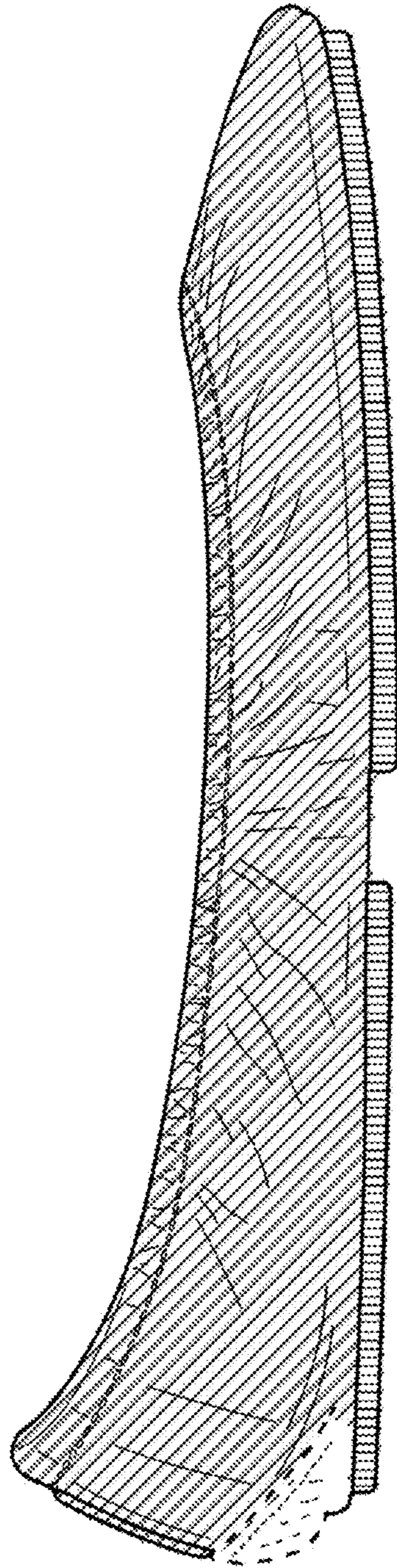

FIG. 37

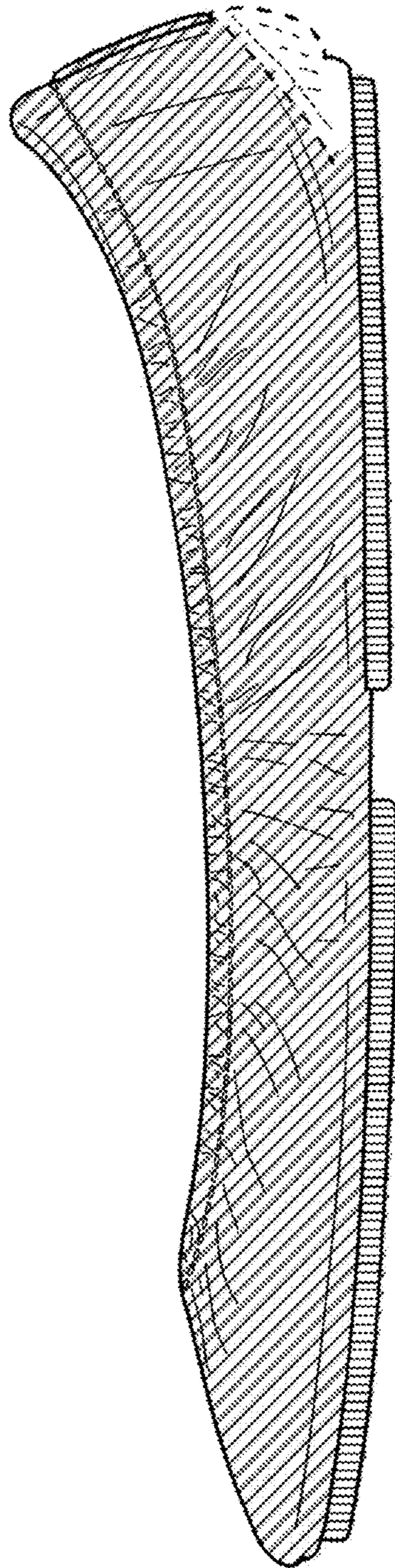

FIG. 38

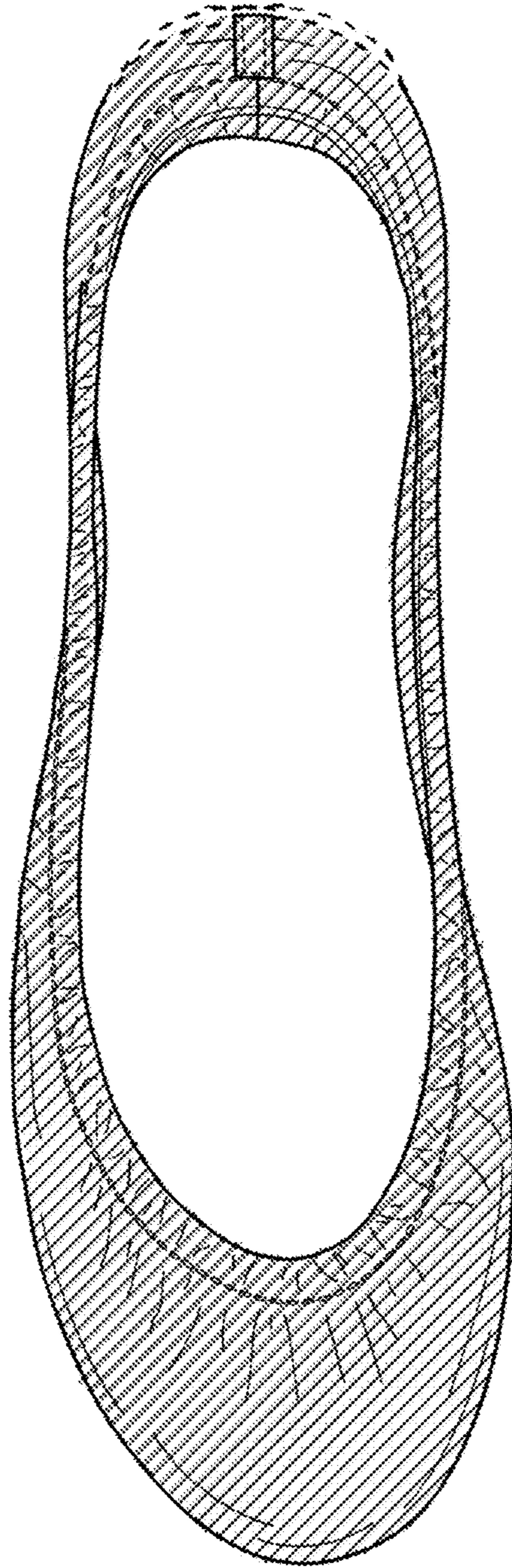

FIG. 39

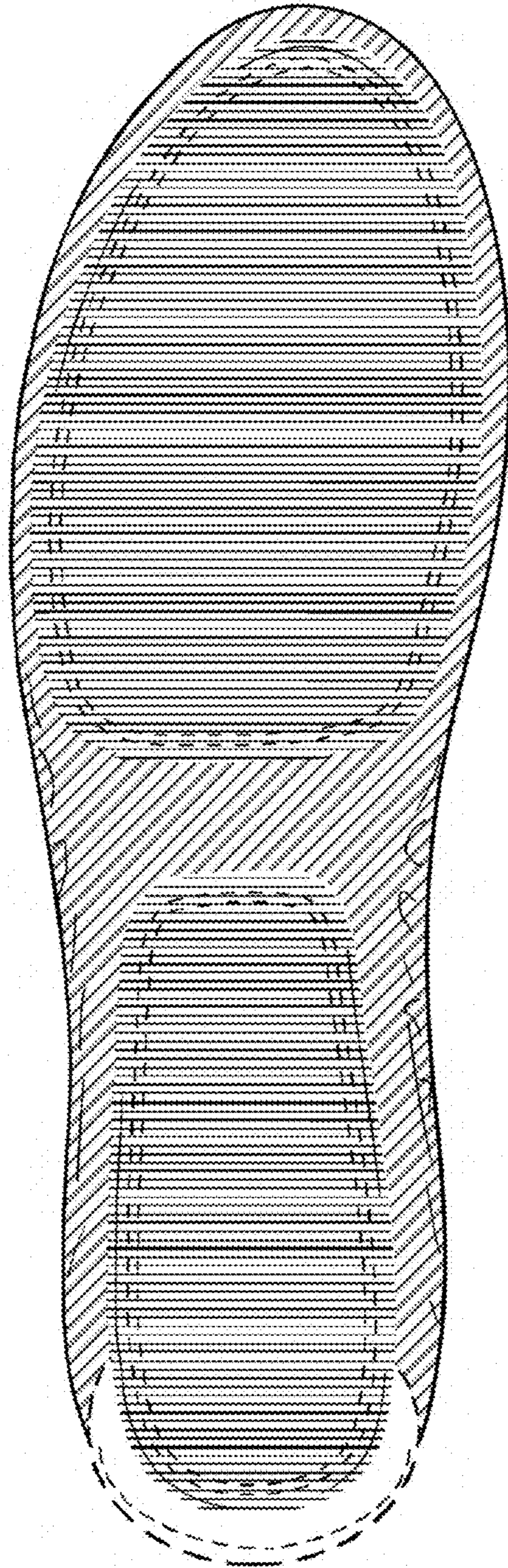

FIG. 40

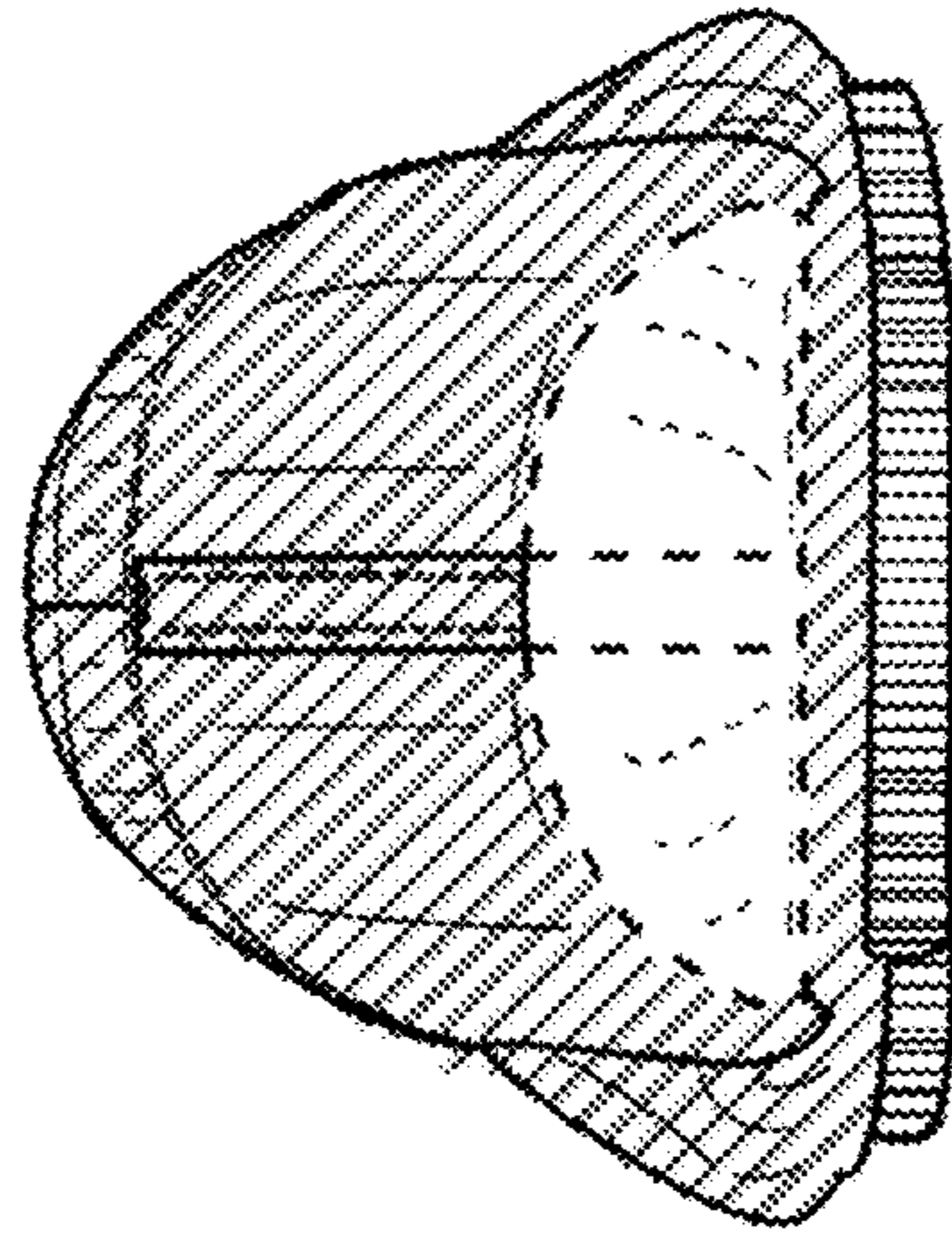

FIG. 42

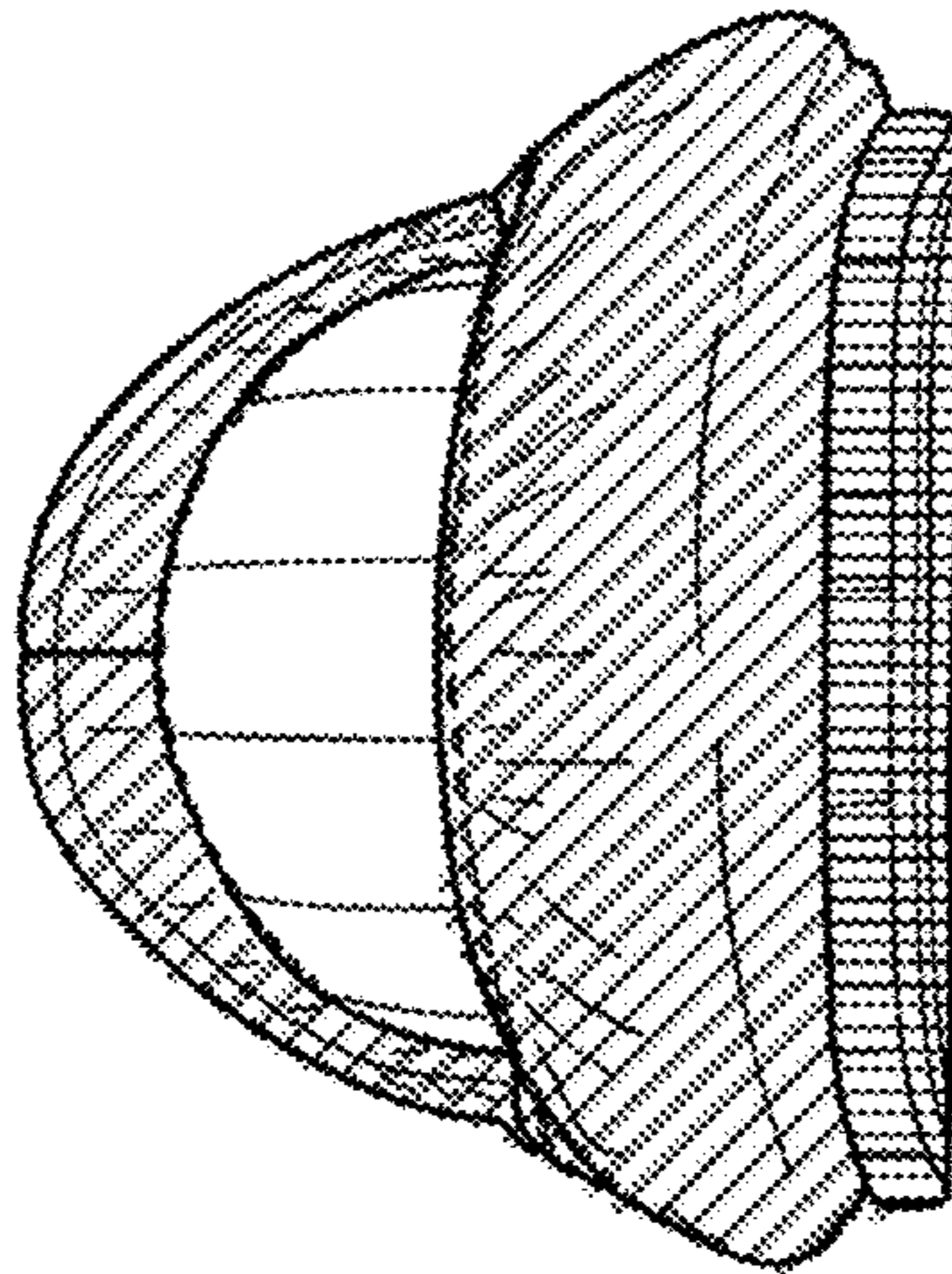

FIG. 41

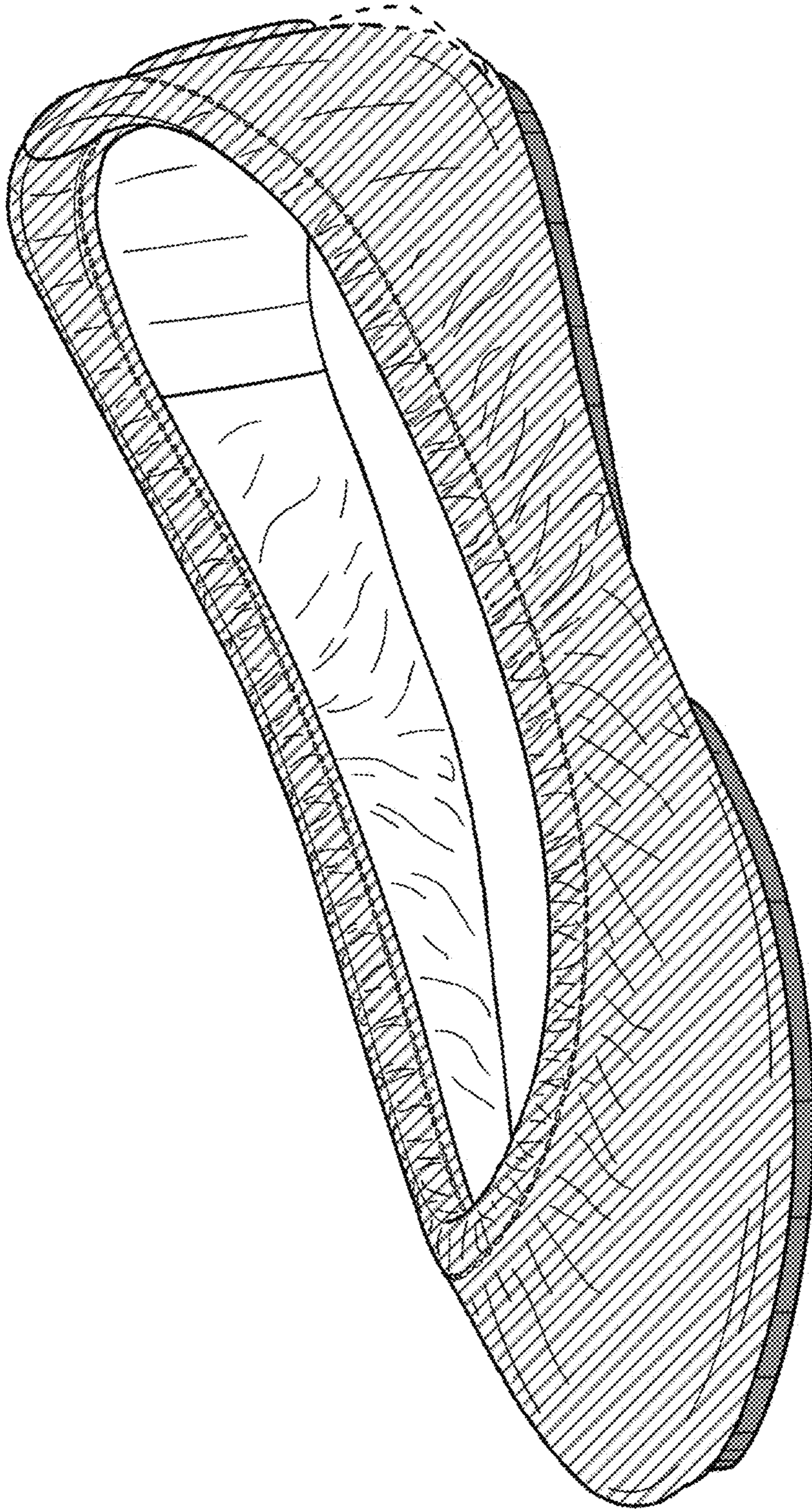

FIG. 43

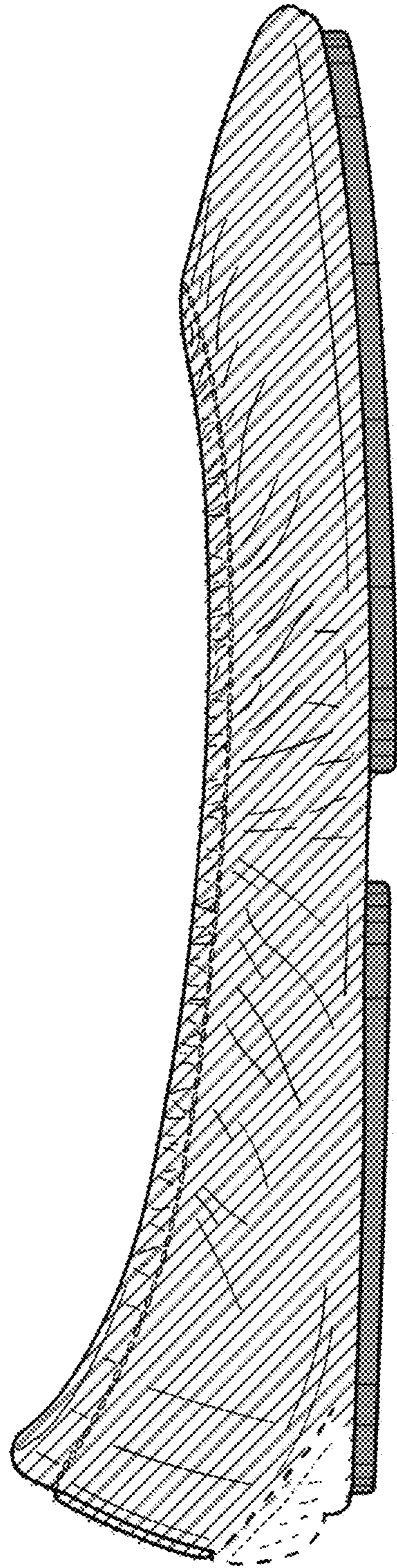

FIG. 44

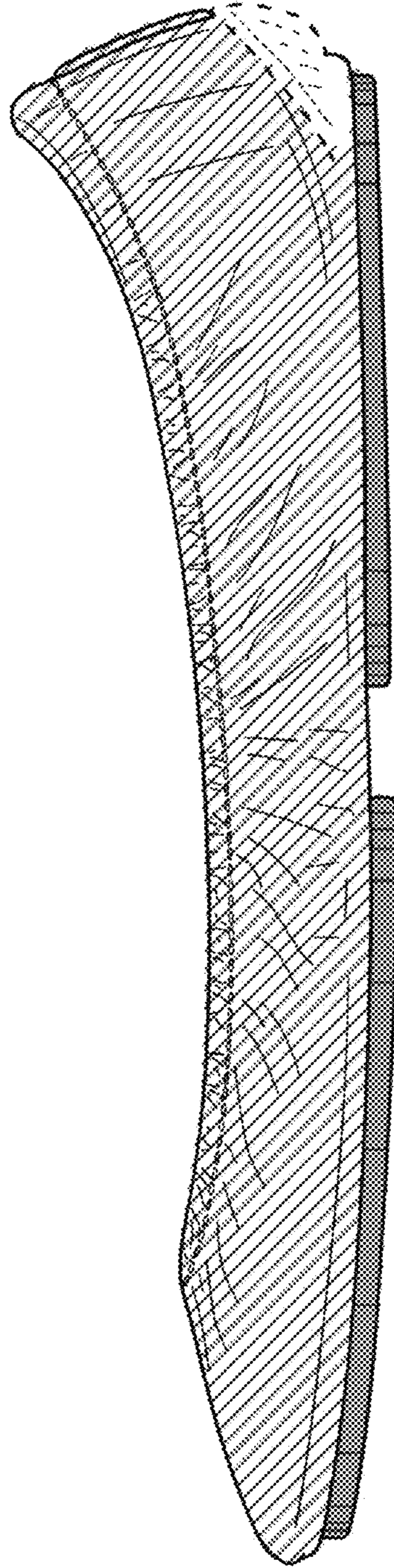

FIG. 45

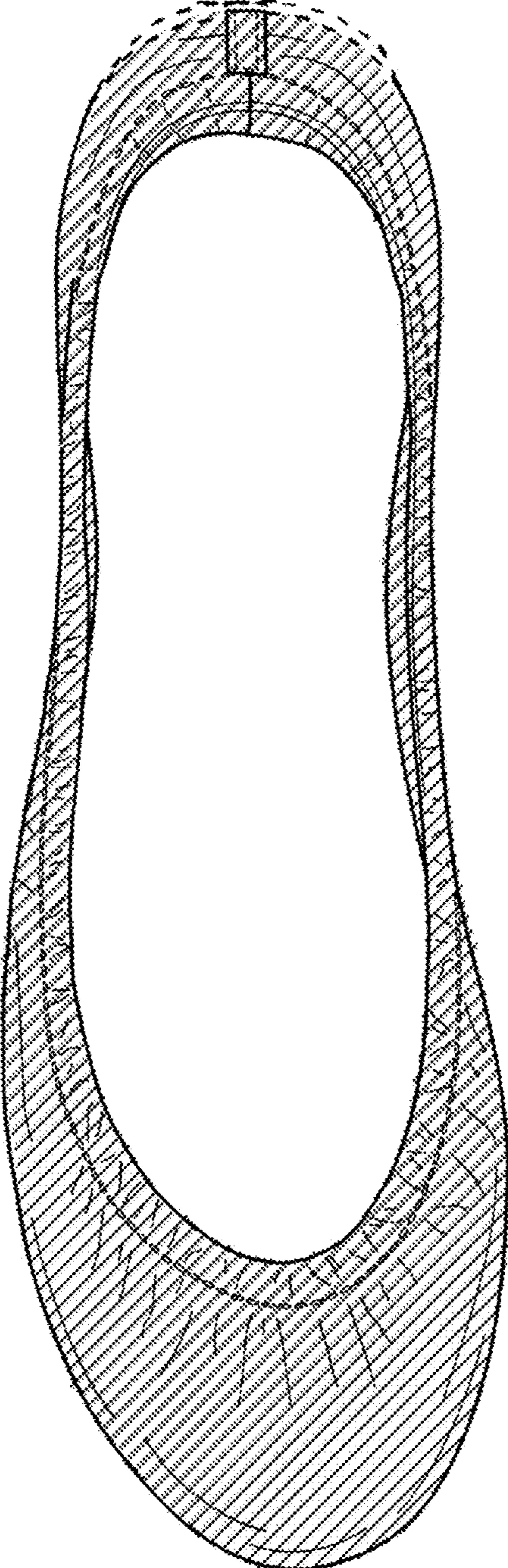

FIG. 46

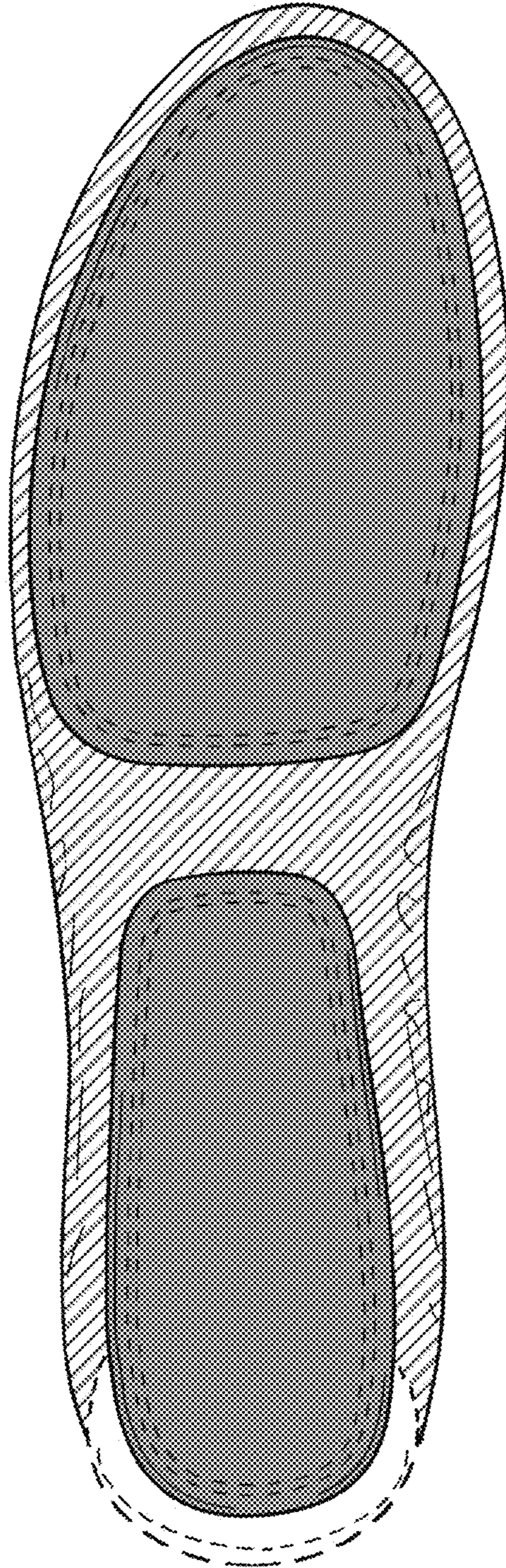

FIG. 47

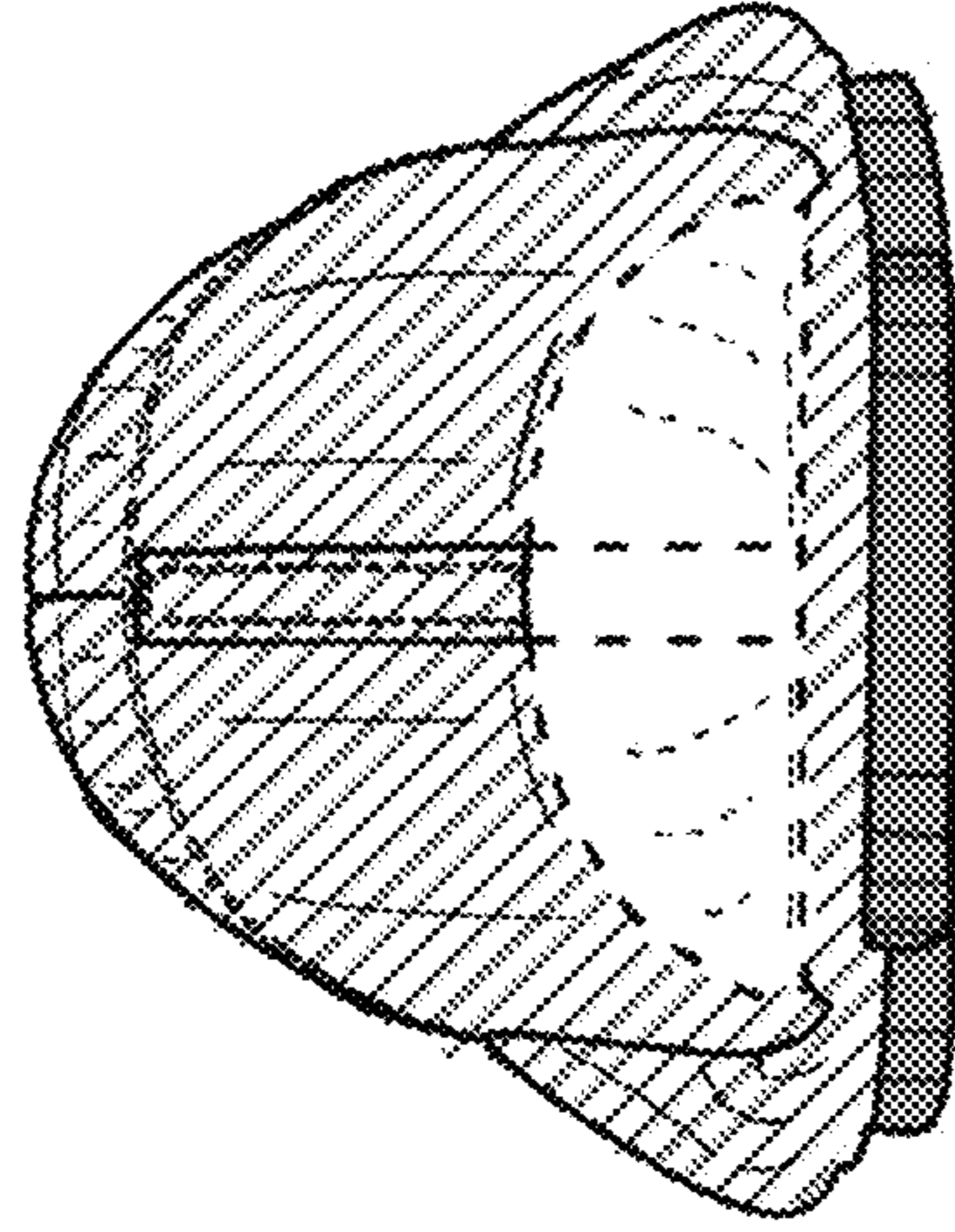

FIG. 48

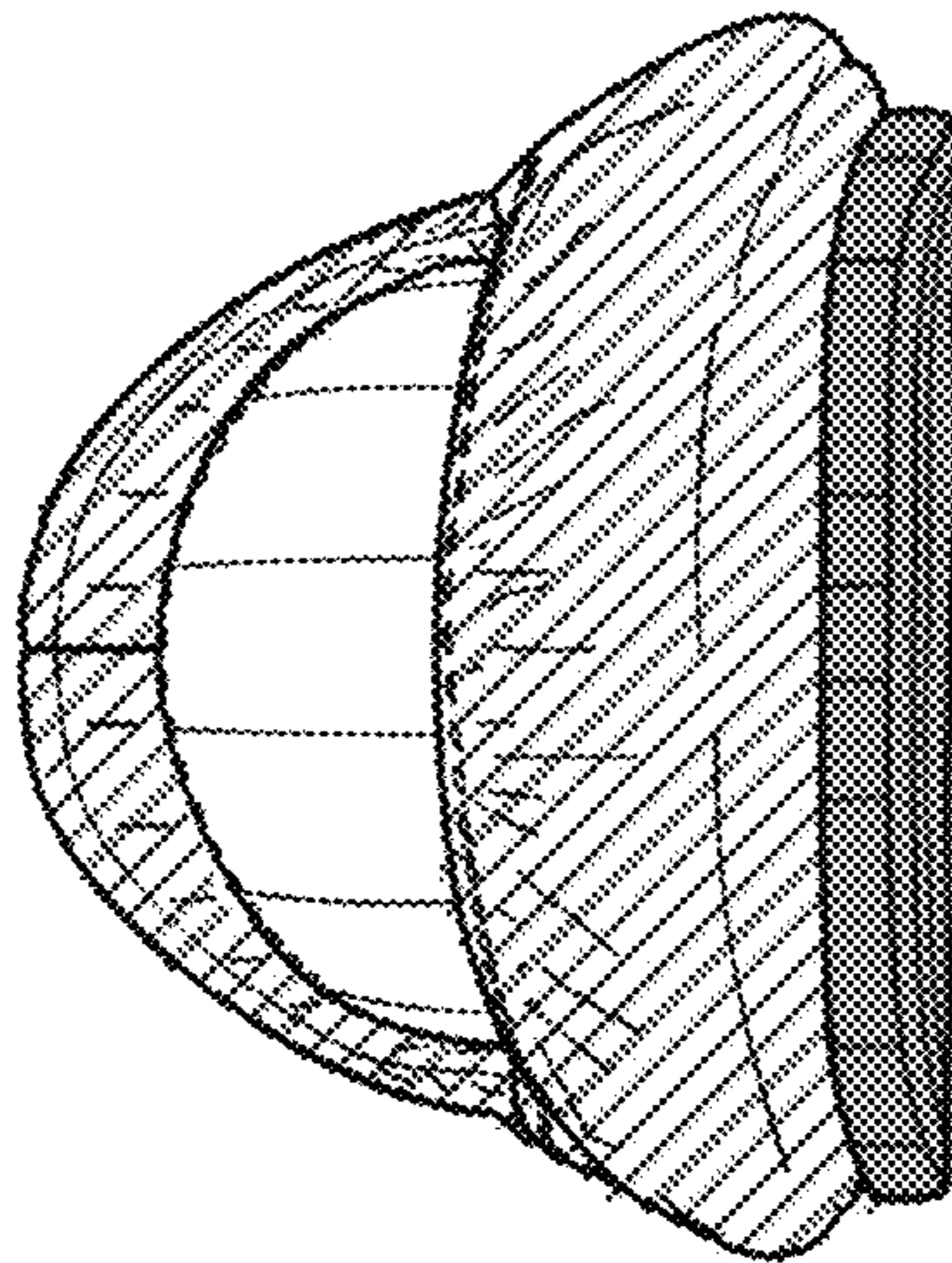

FIG. 49

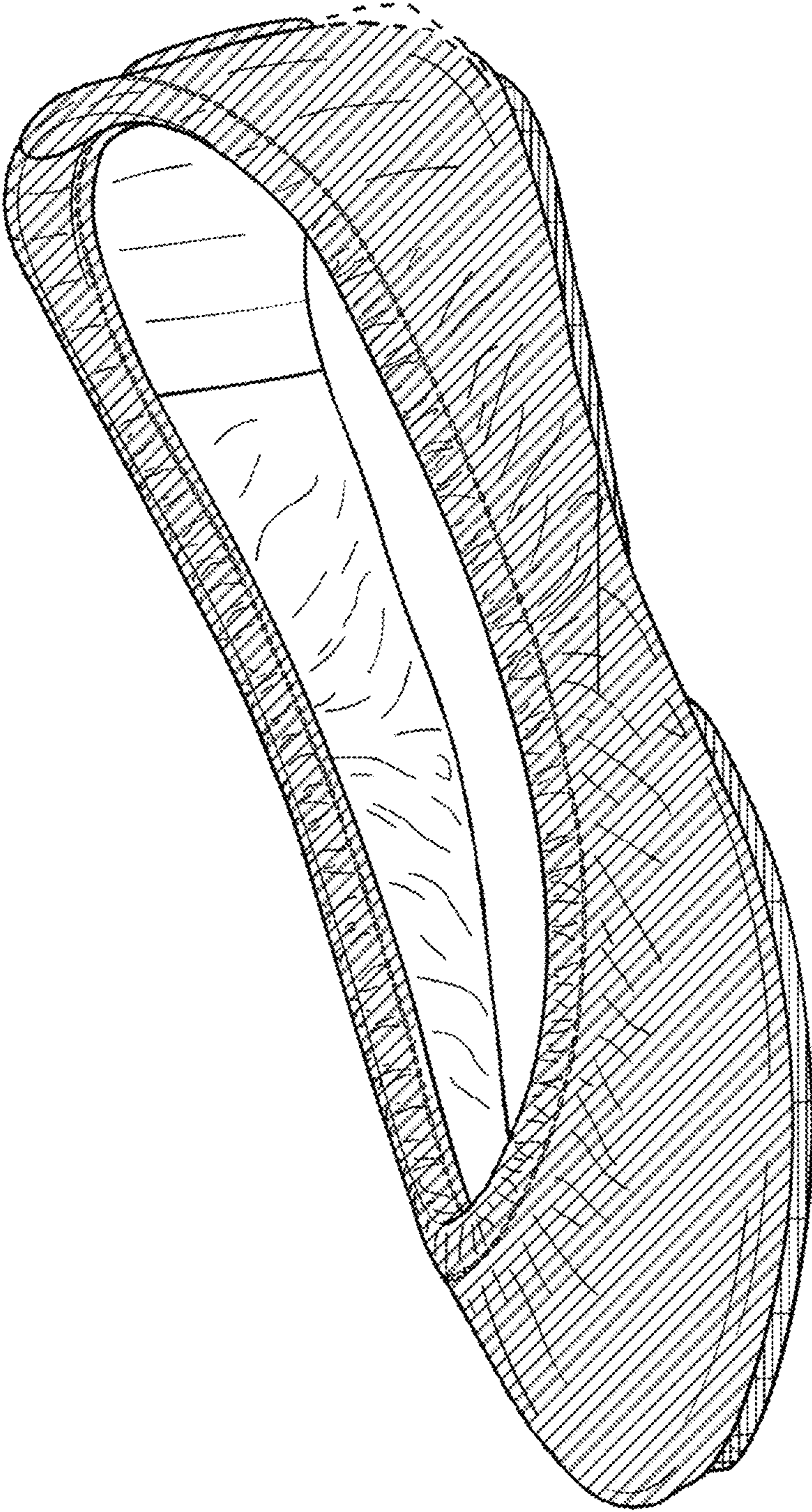

FIG. 50

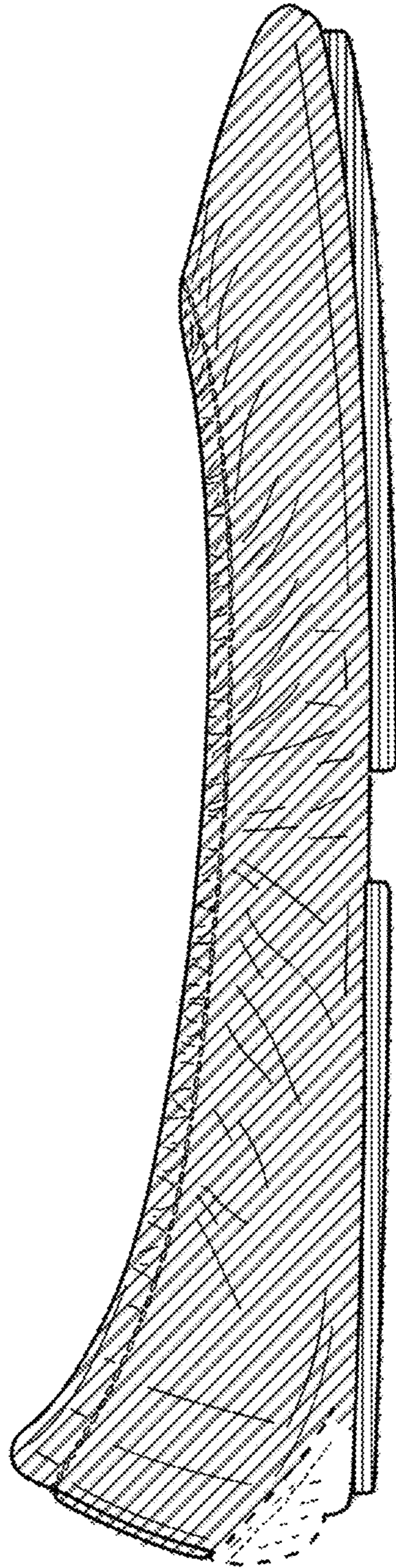

FIG. 51

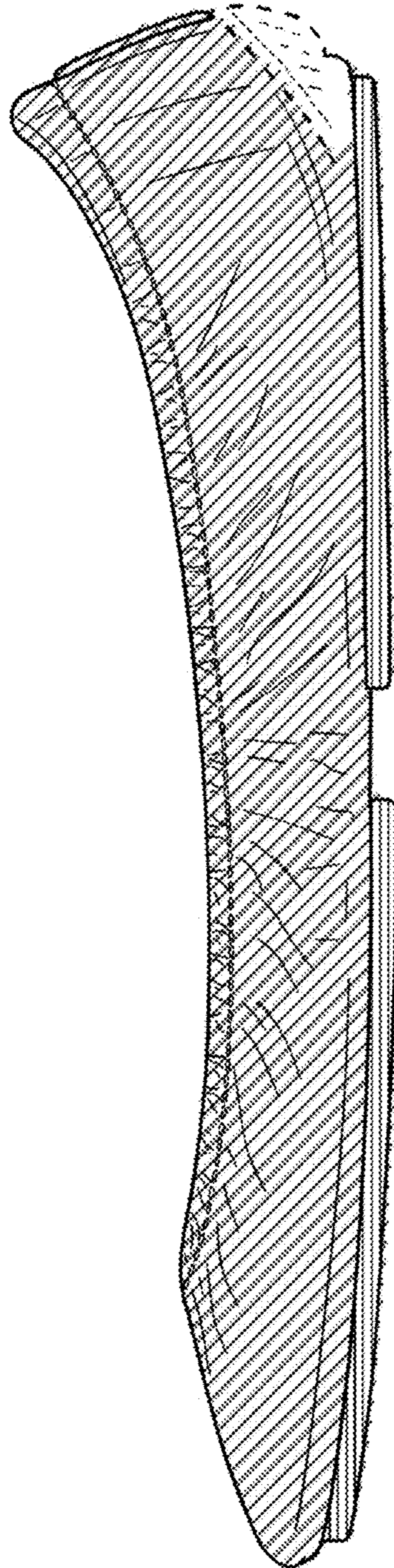

FIG. 52

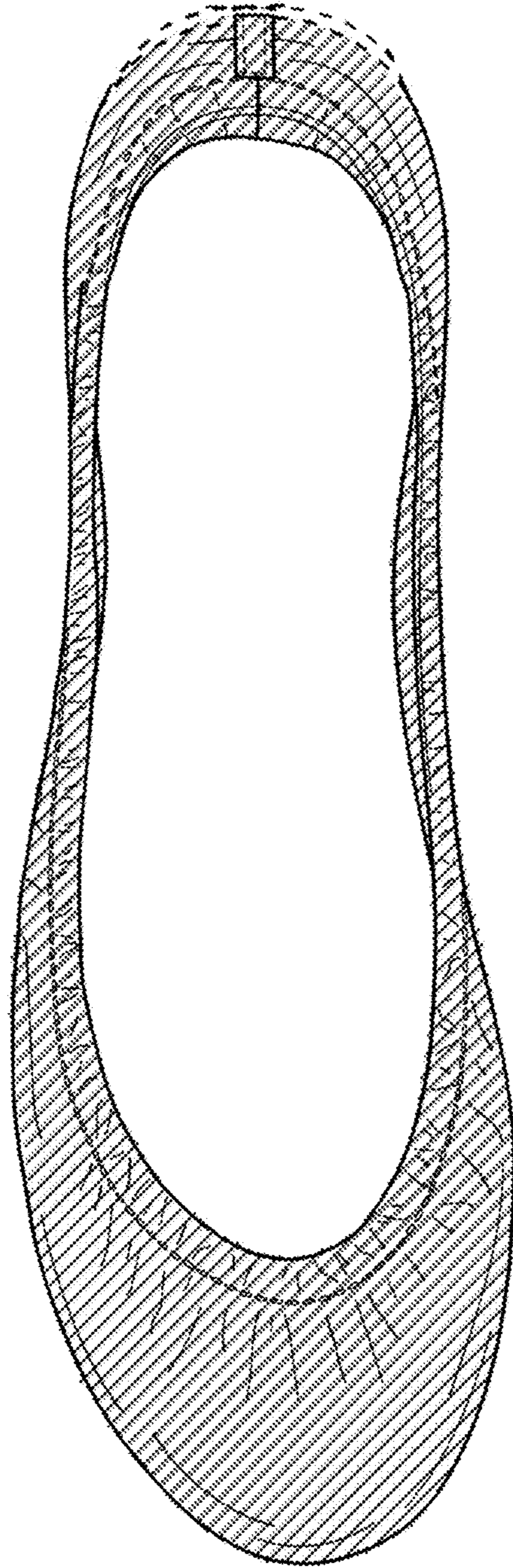

FIG. 53

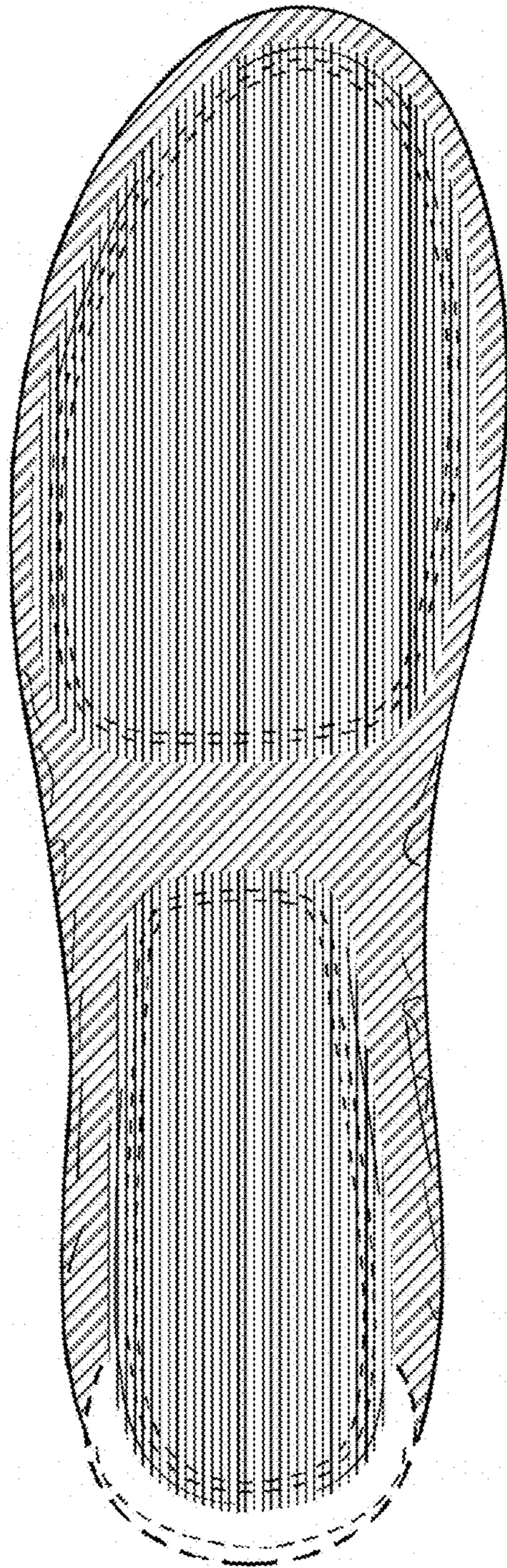

FIG. 54

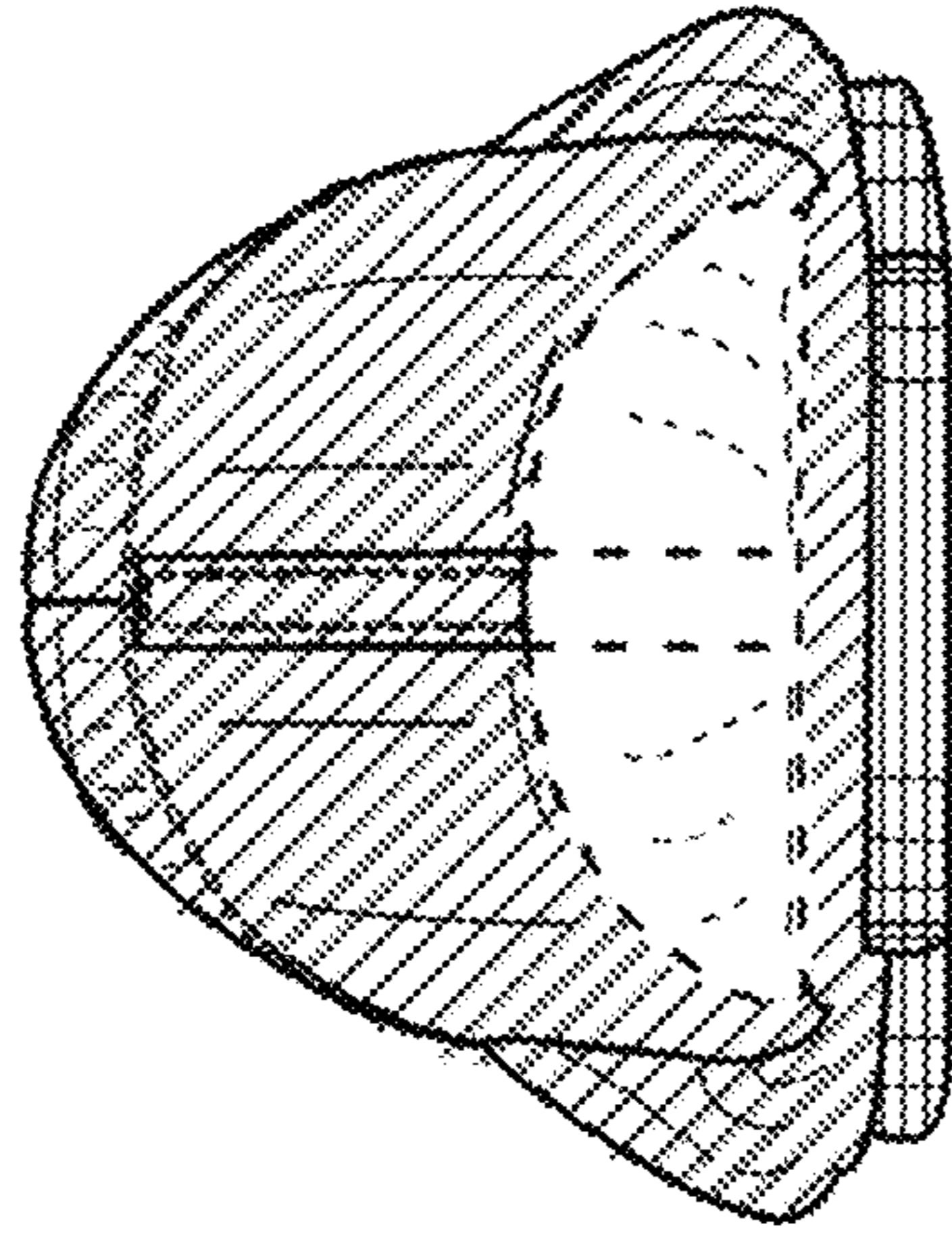

FIG. 55

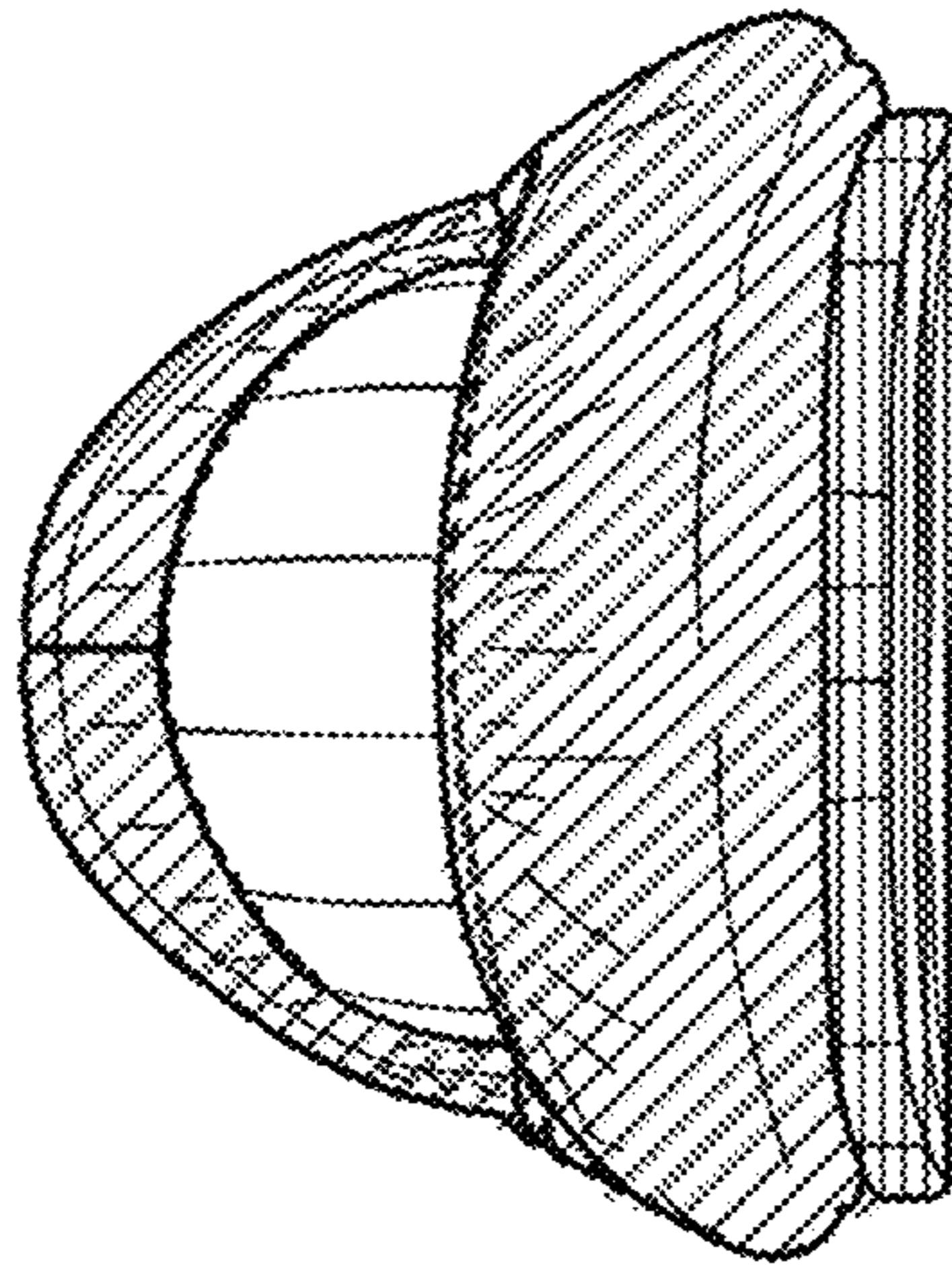

FIG. 56

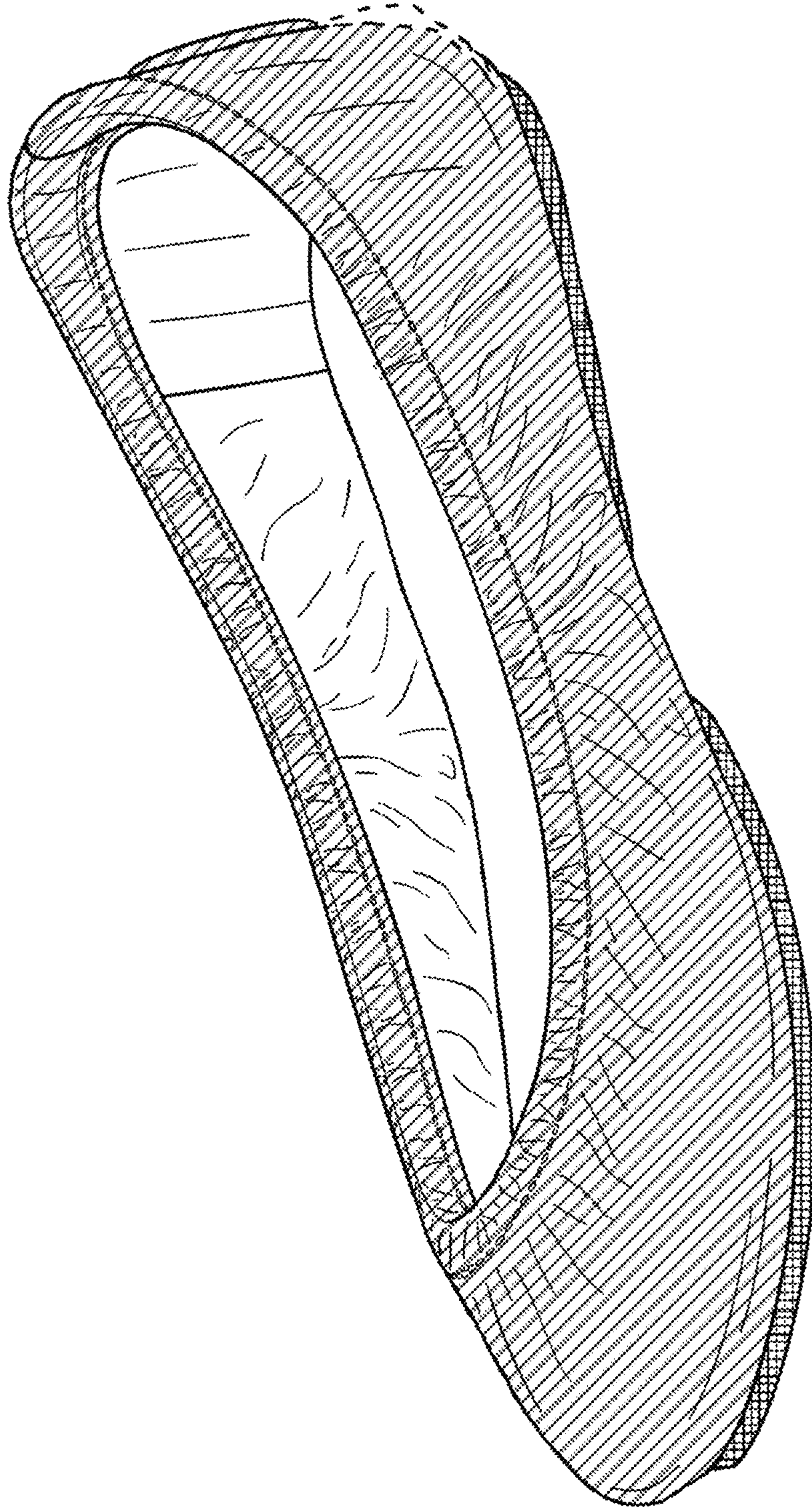

FIG. 57

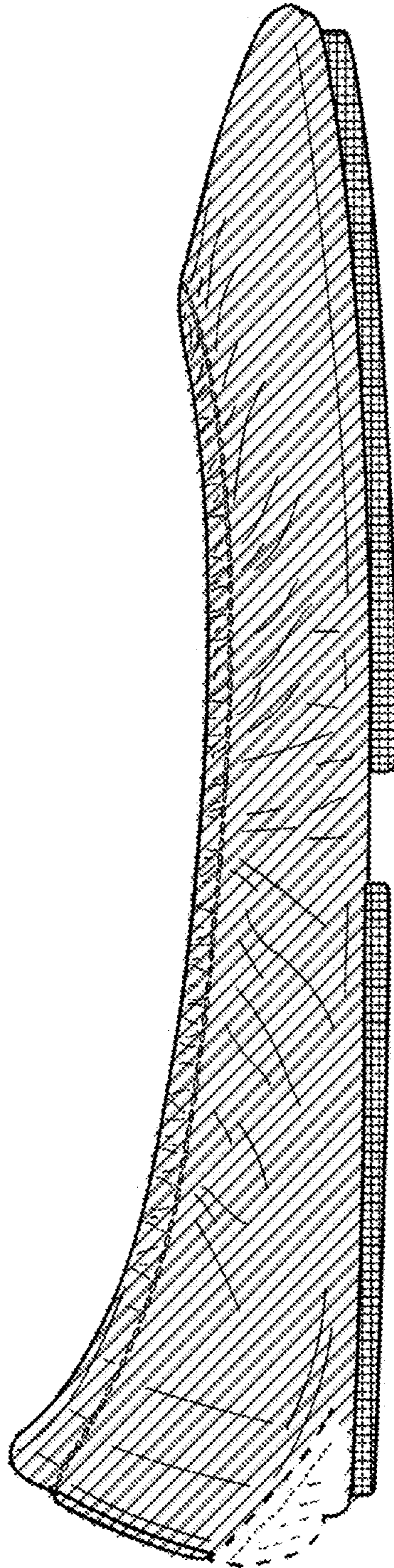

FIG. 58

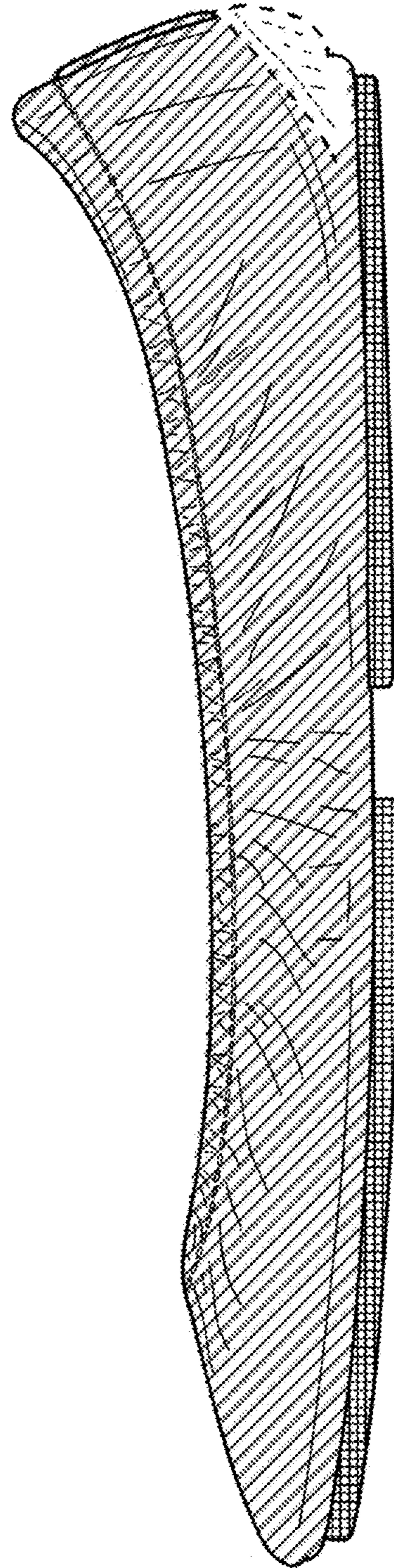

FIG. 59

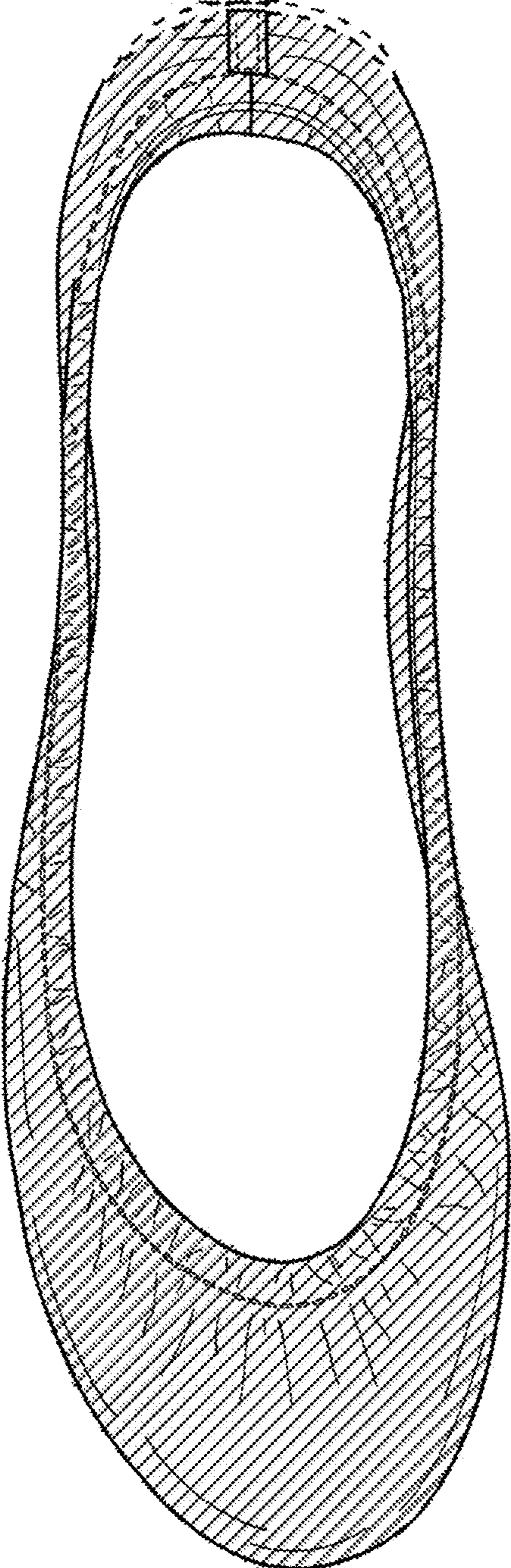

FIG. 60

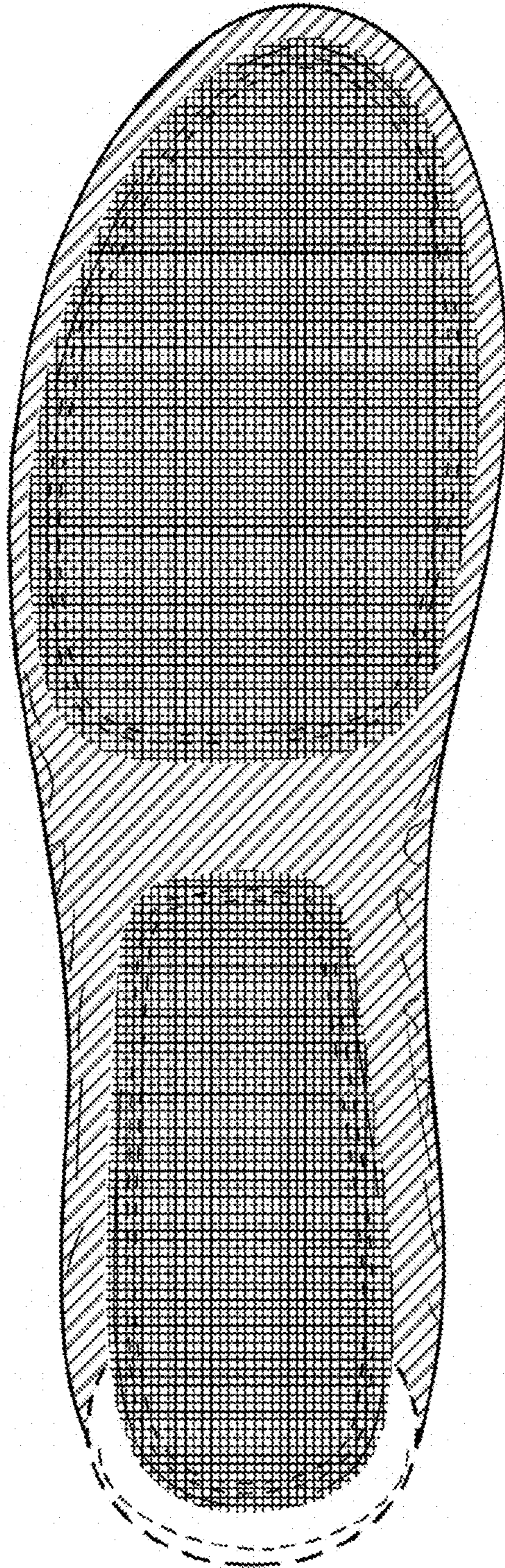

FIG. 61

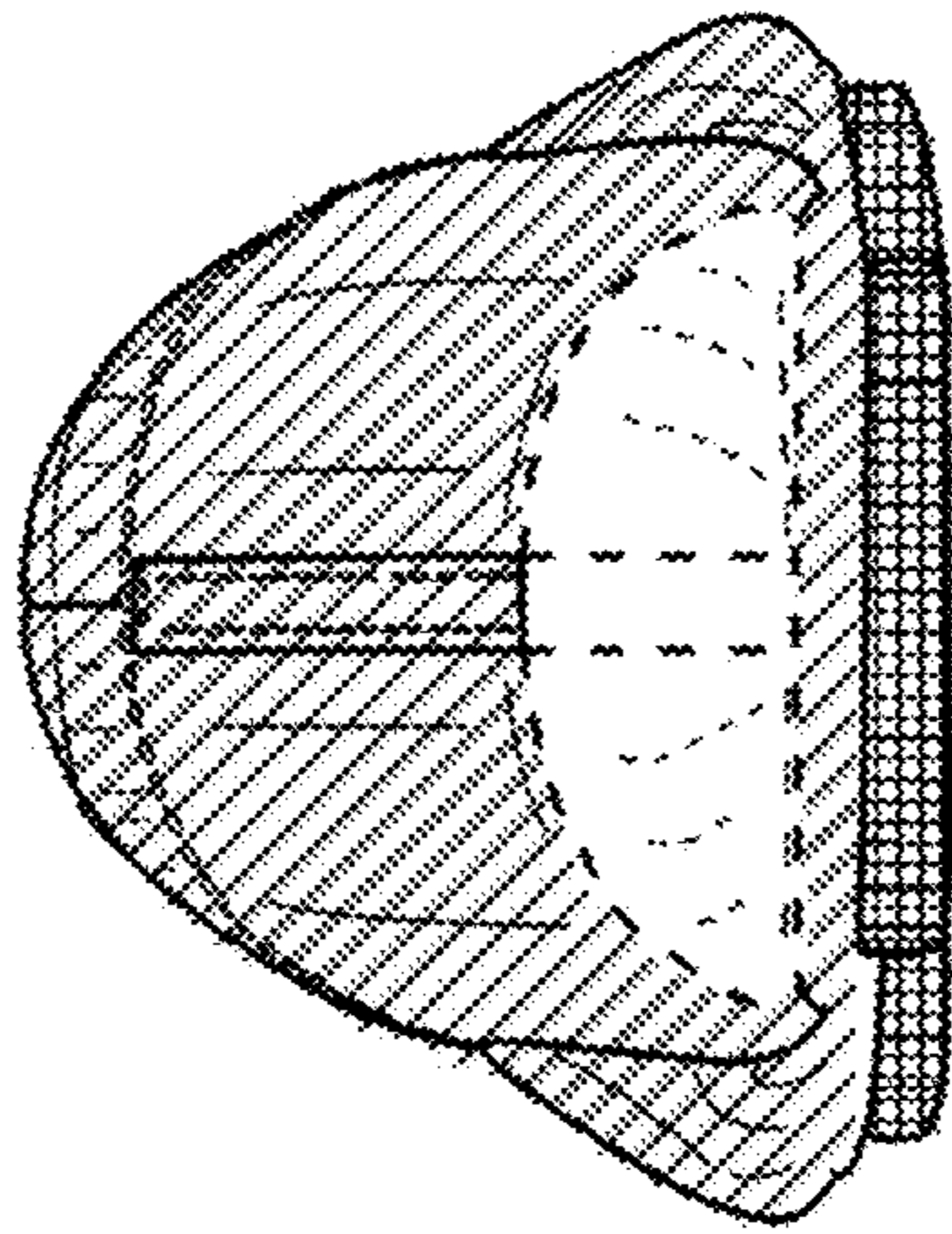

FIG. 62

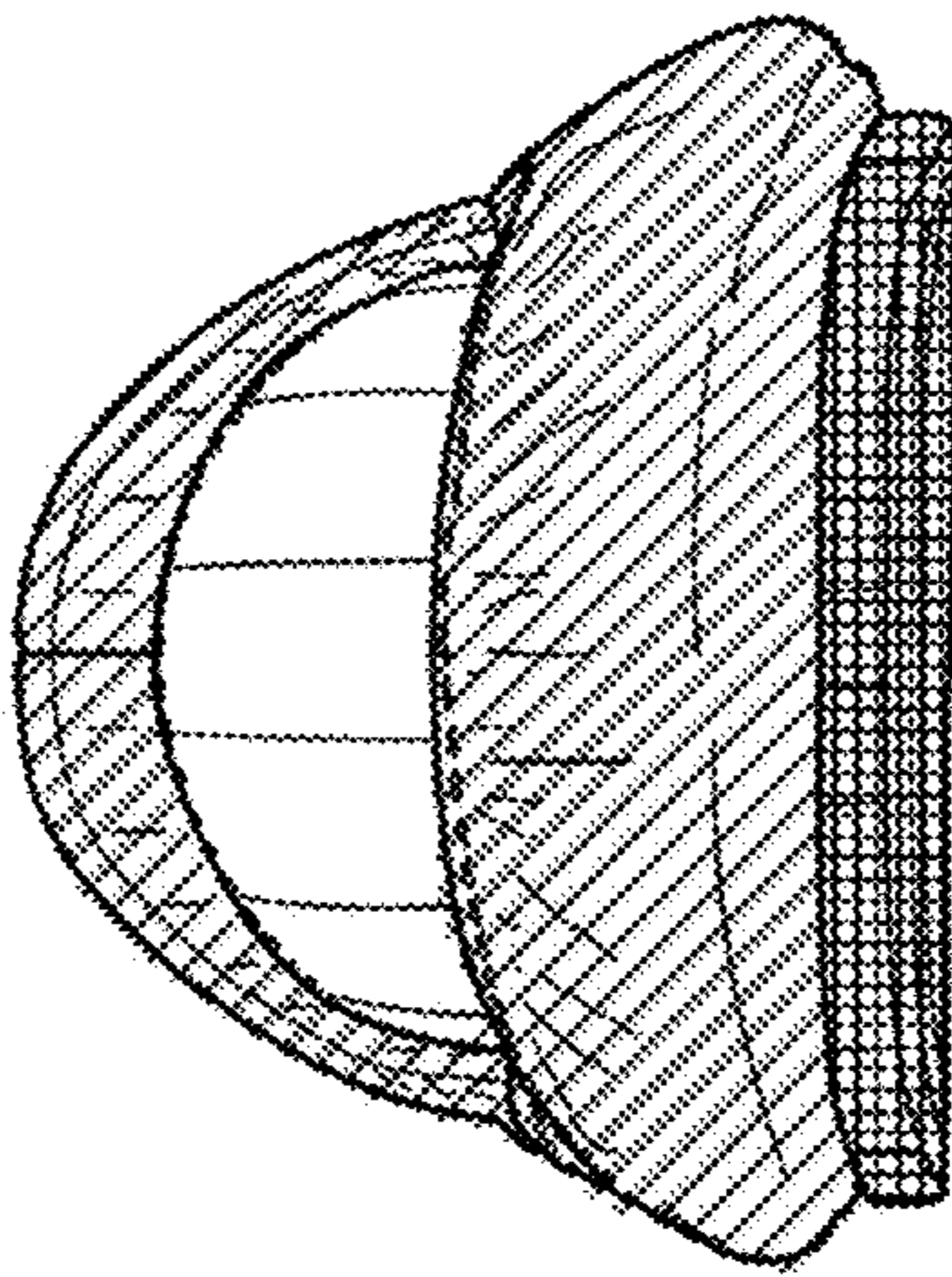

FIG. 63

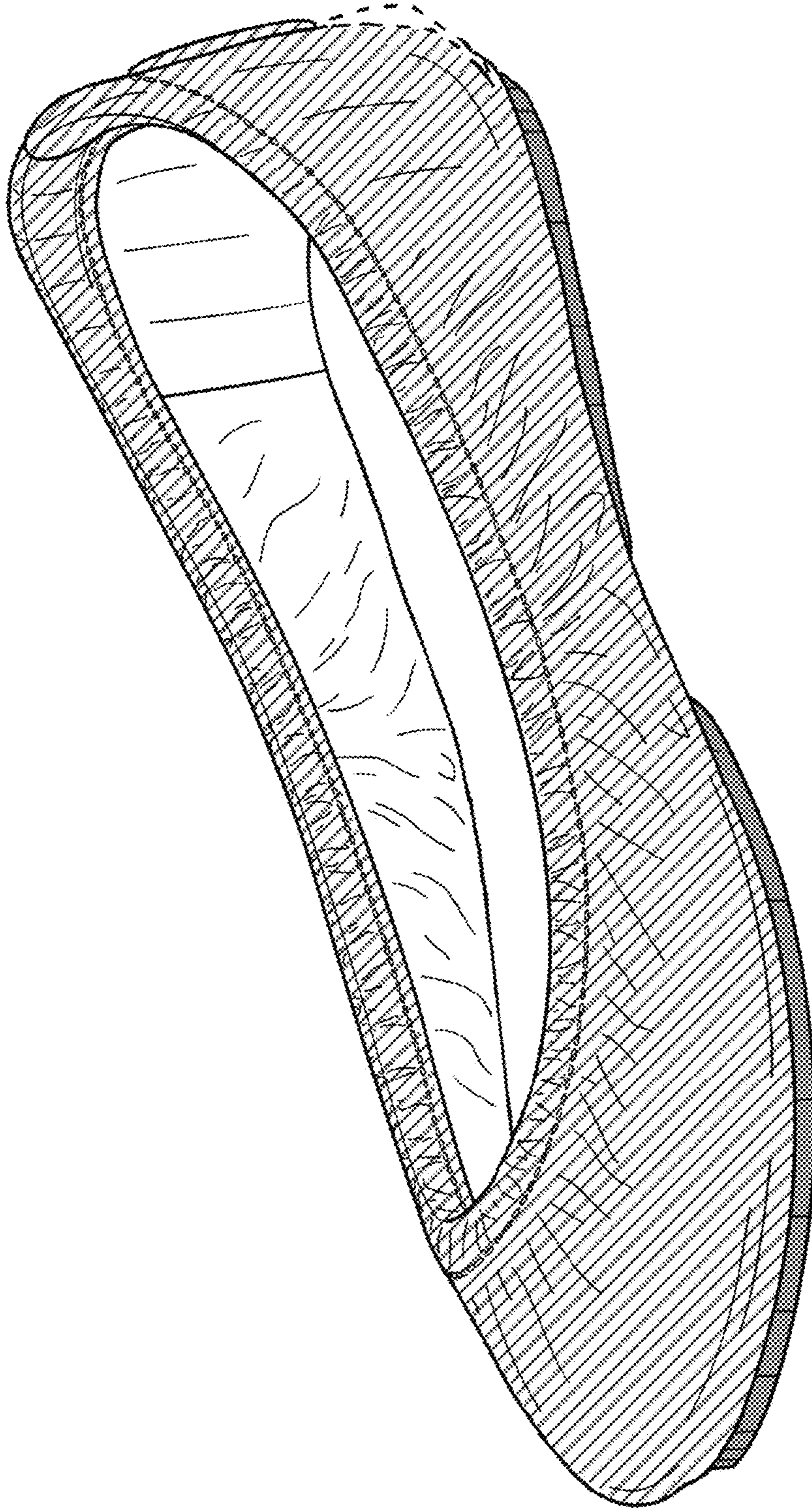

FIG. 64

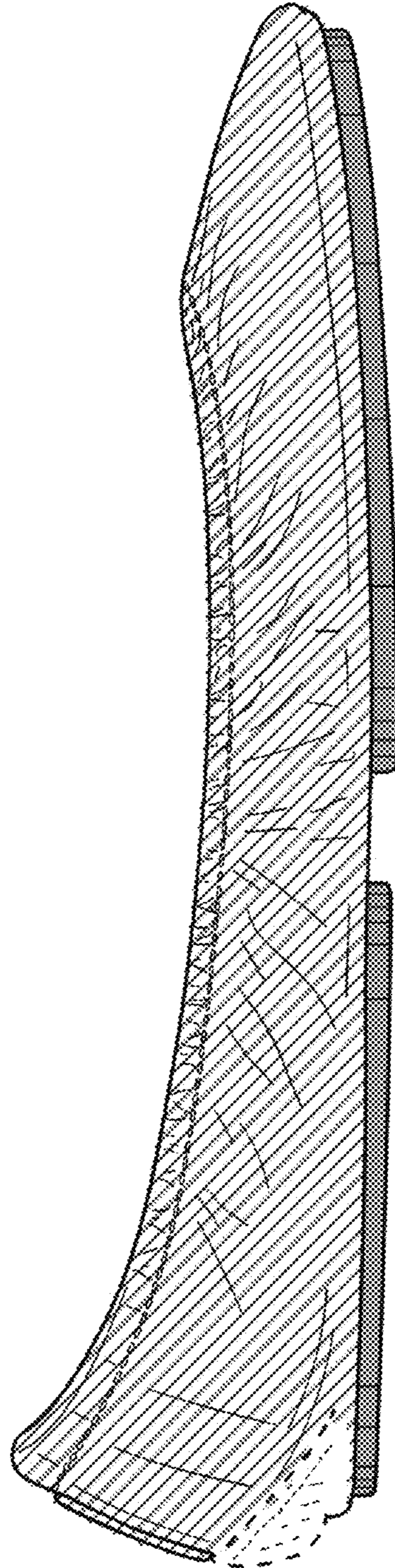

FIG. 65

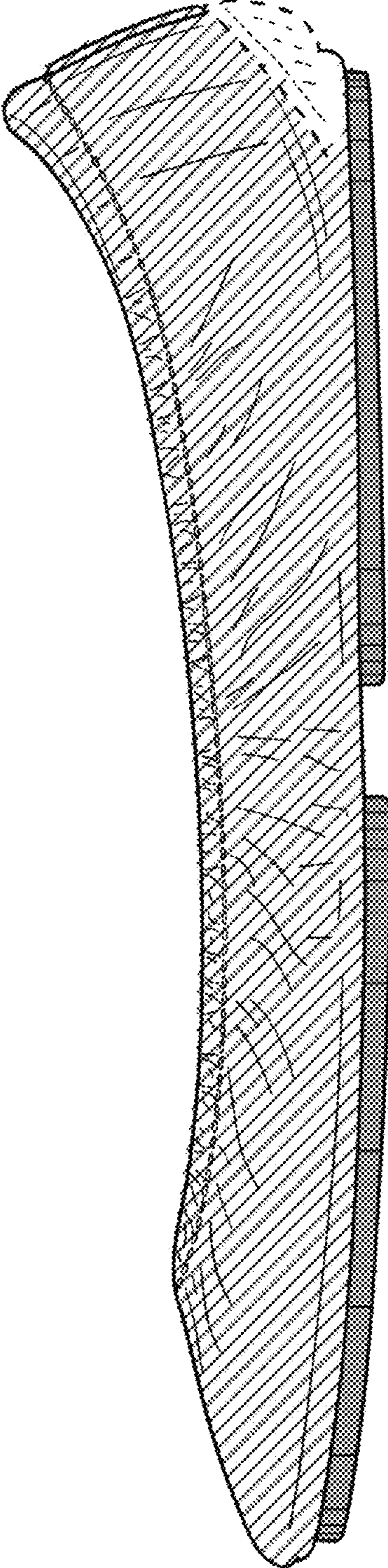

FIG. 66

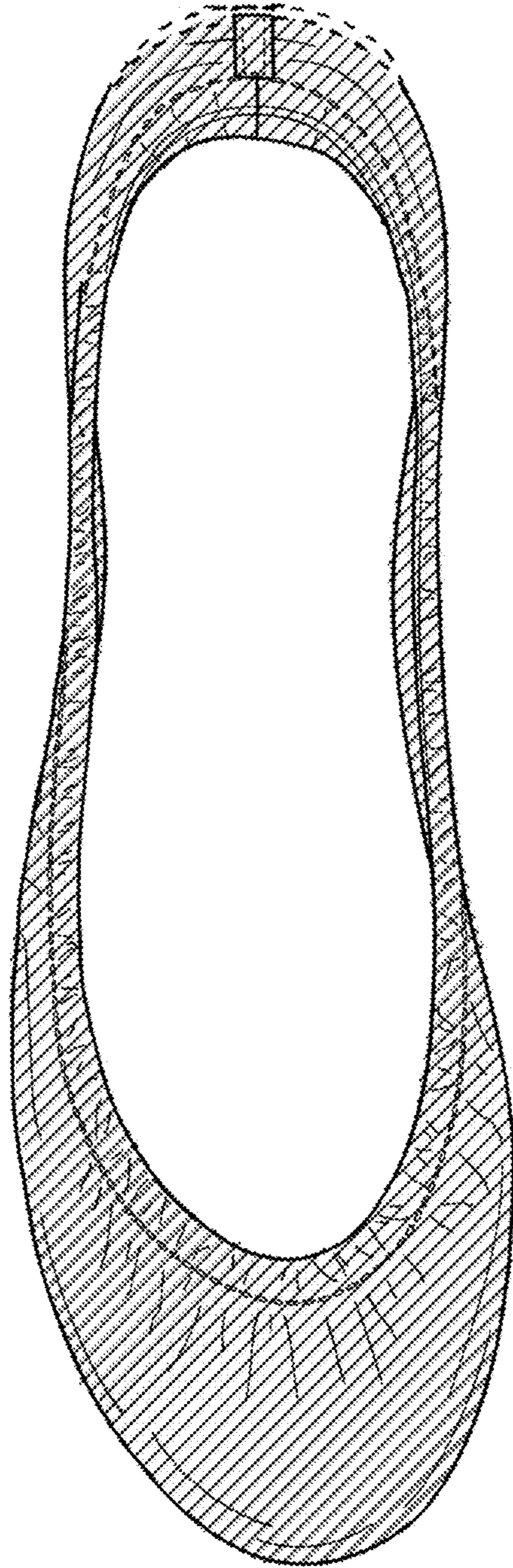

FIG. 67

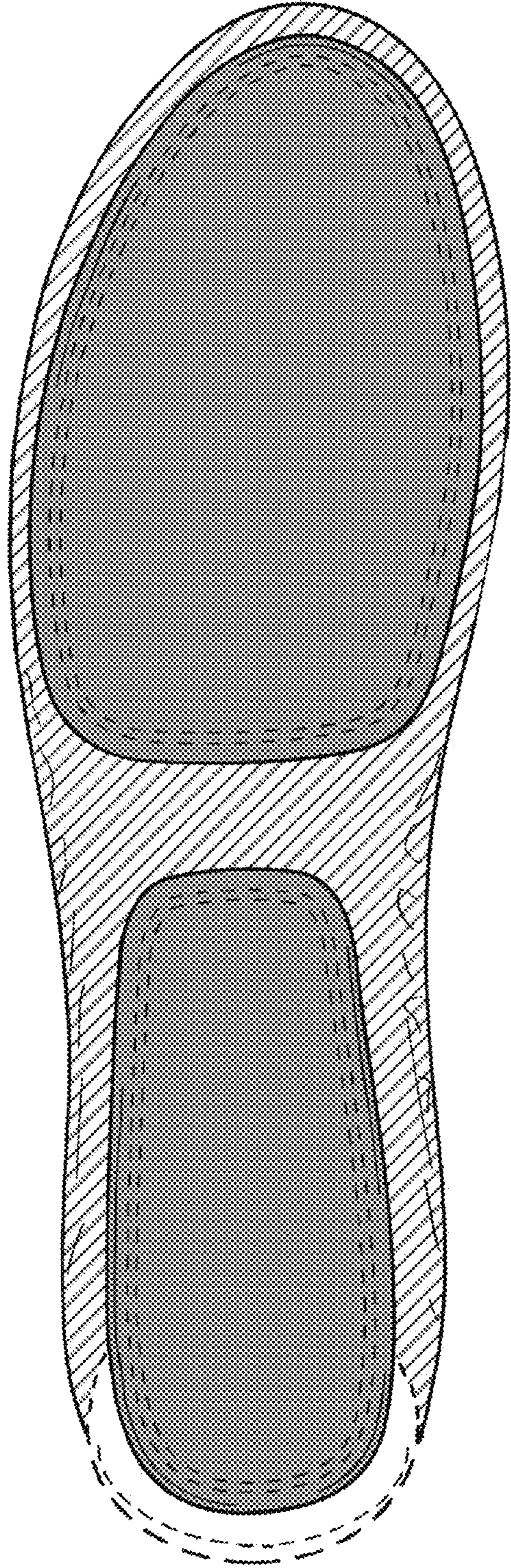

FIG. 68

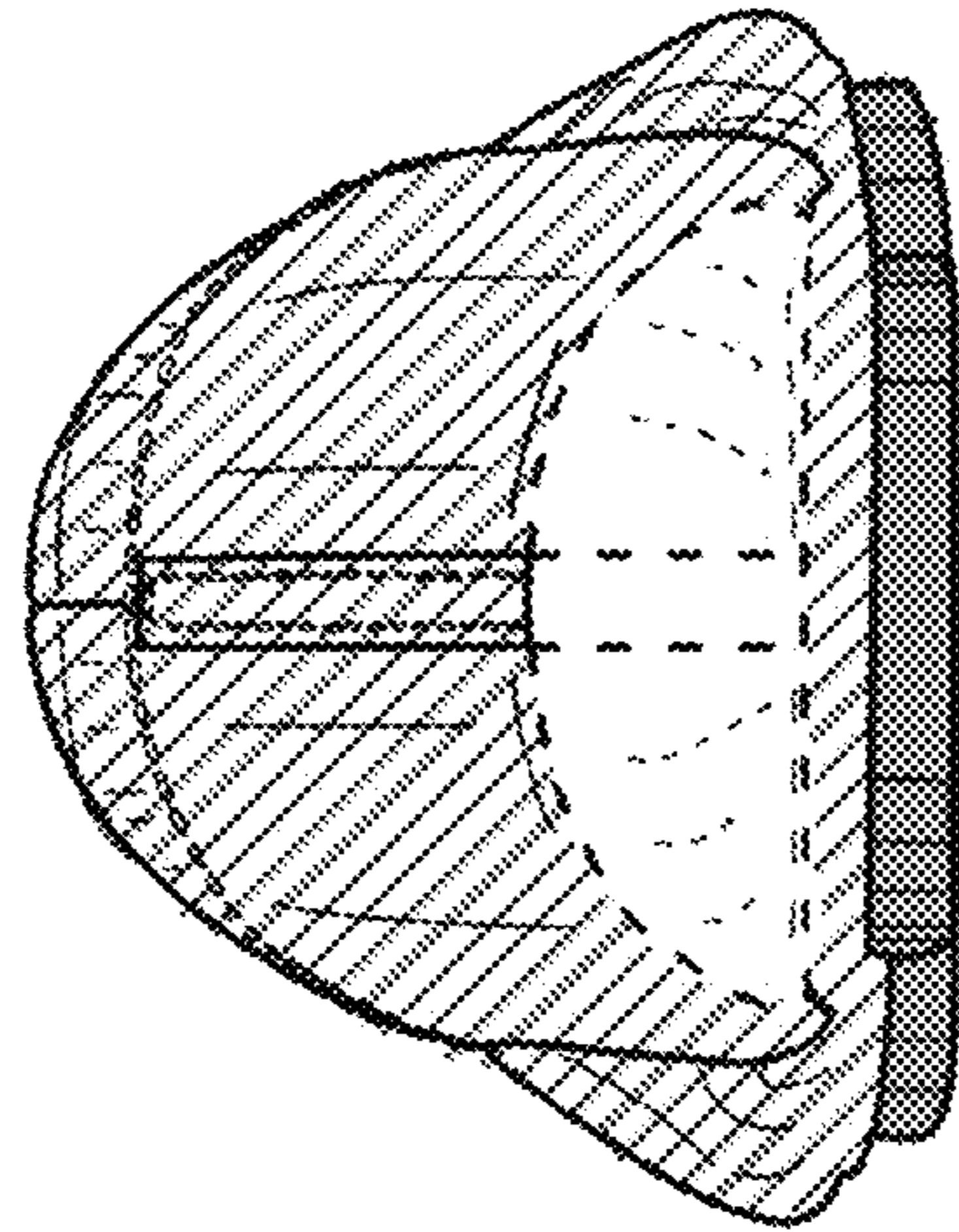

FIG. 69

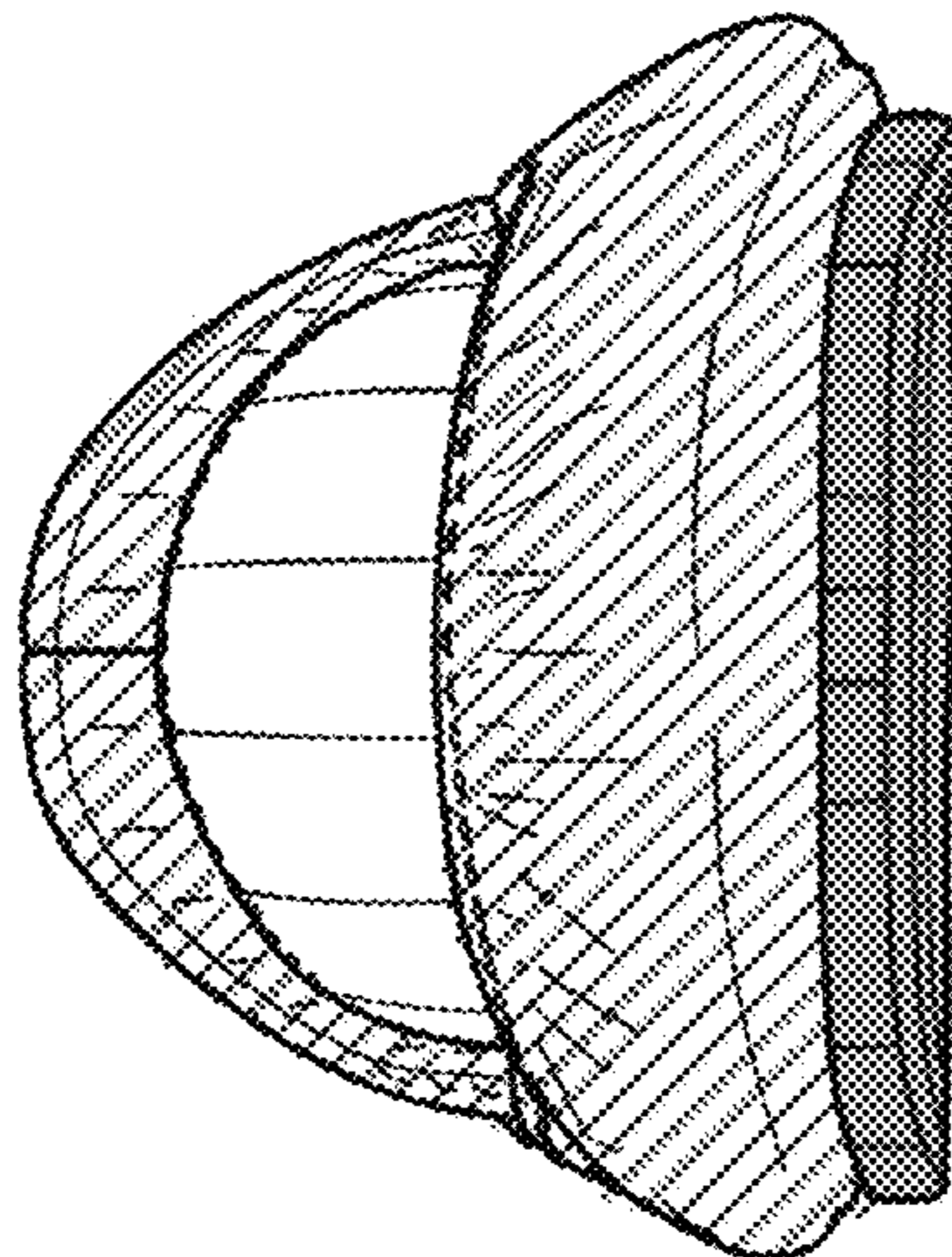

FIG. 70

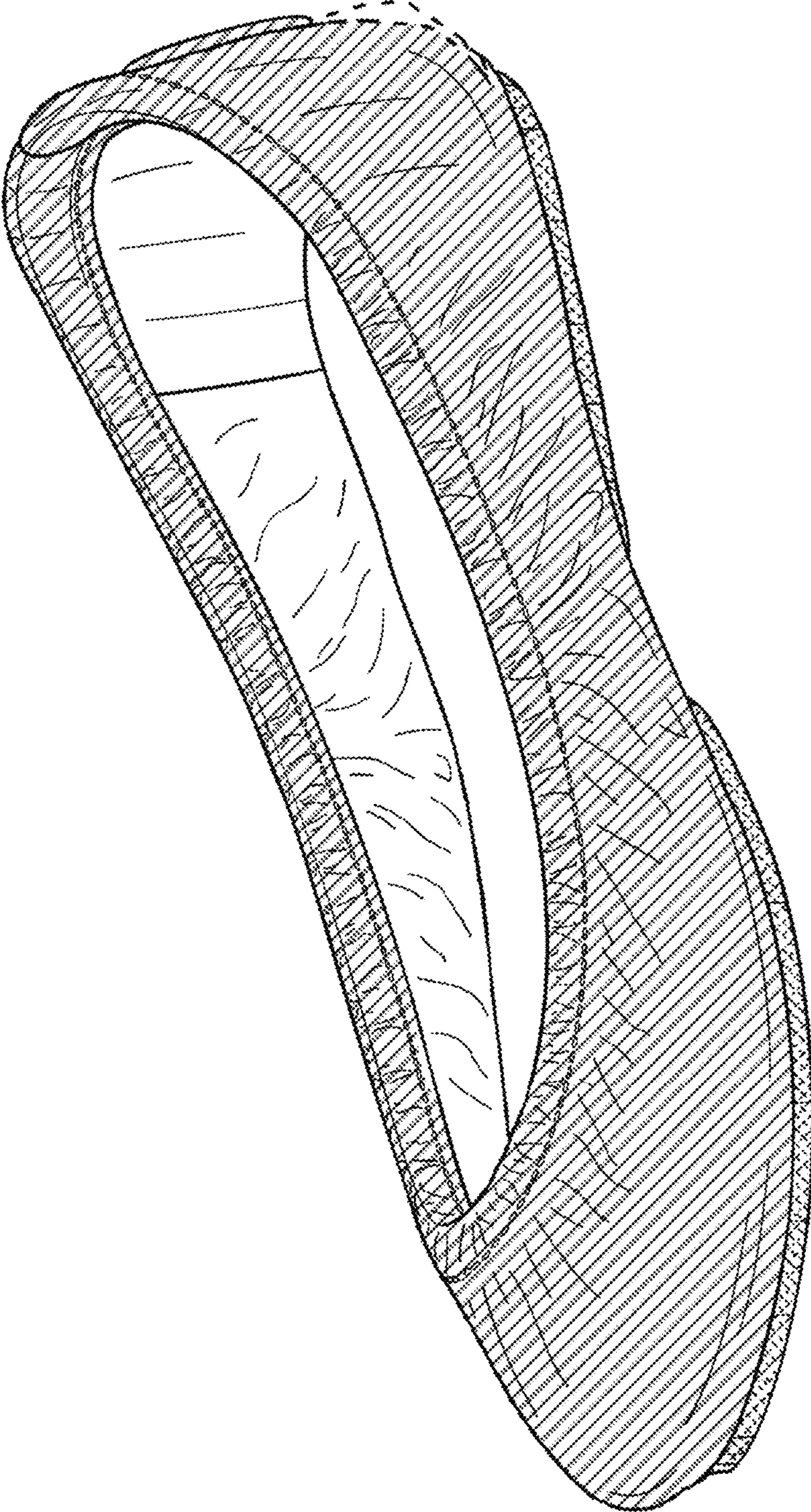

FIG. 71

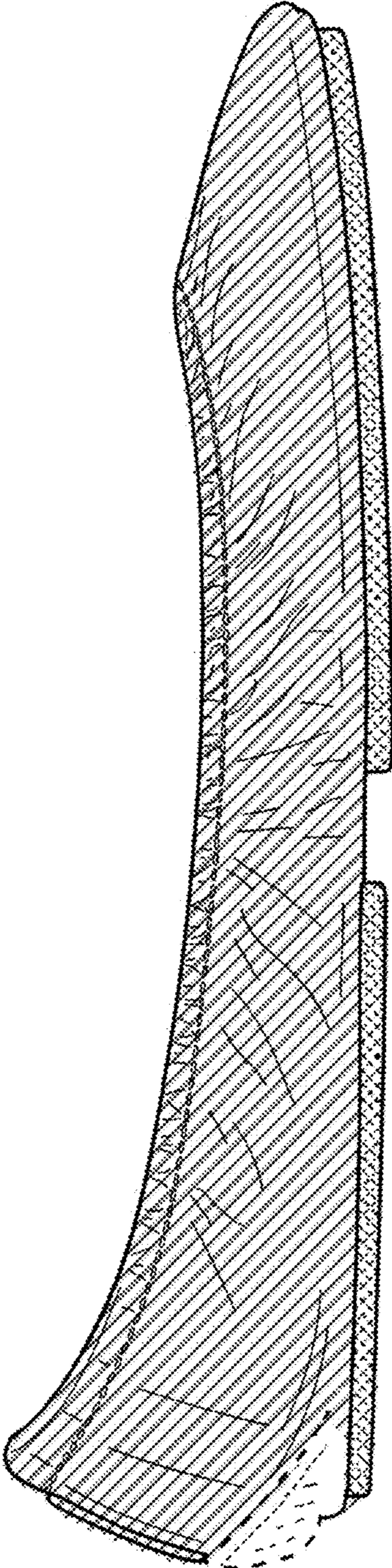

FIG. 72

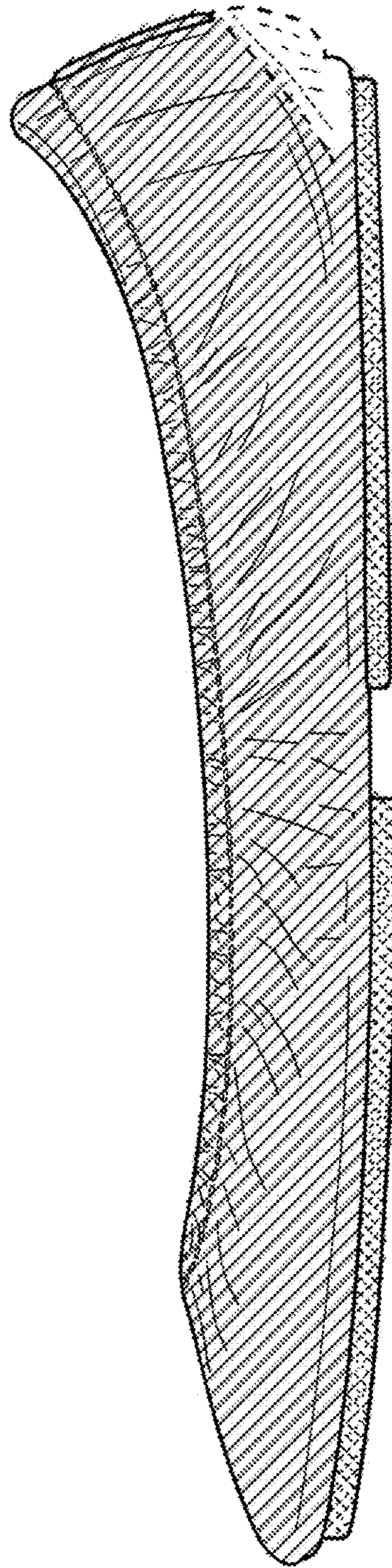

FIG. 73

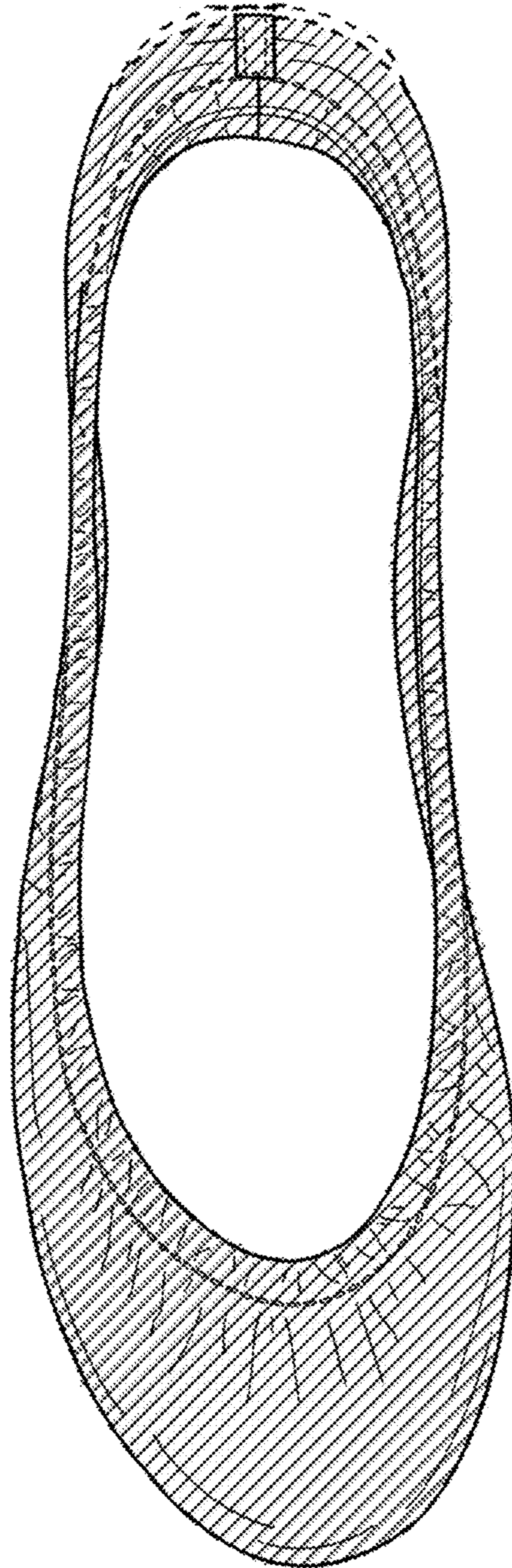

FIG. 74

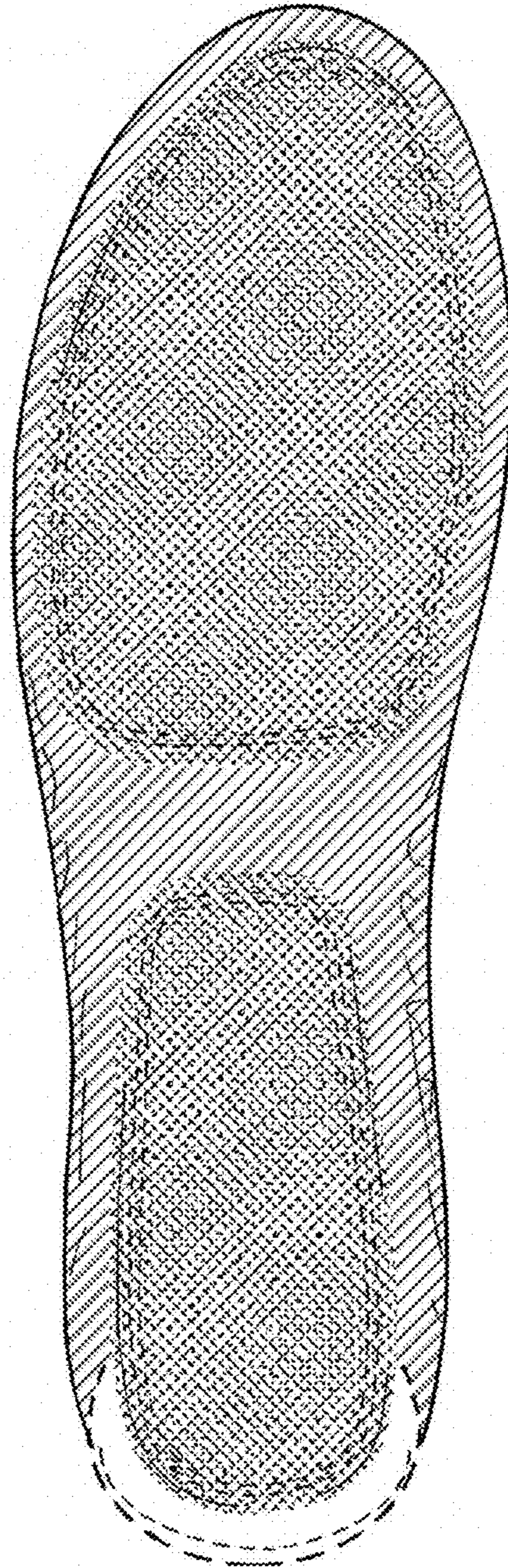

FIG. 75

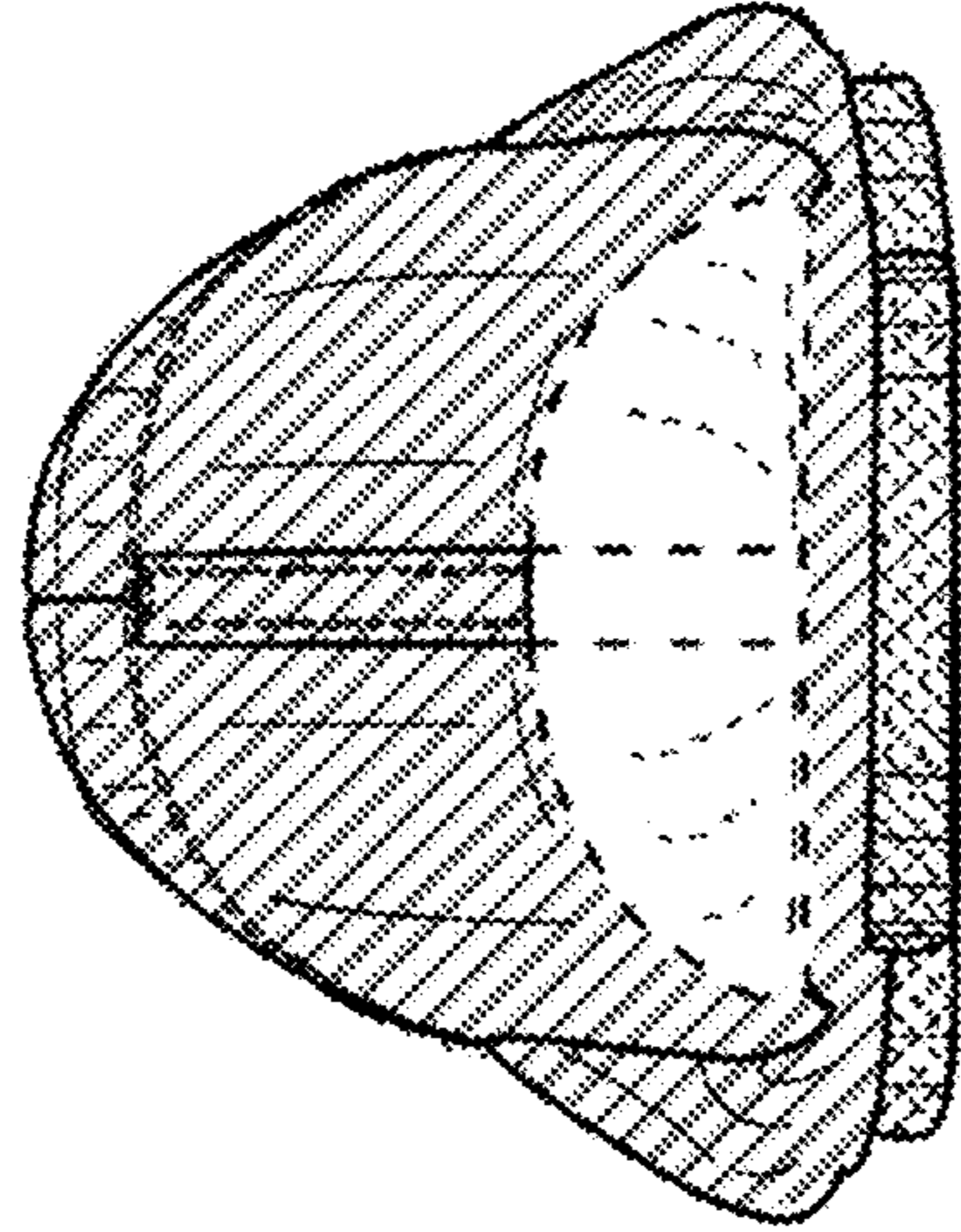

FIG. 77

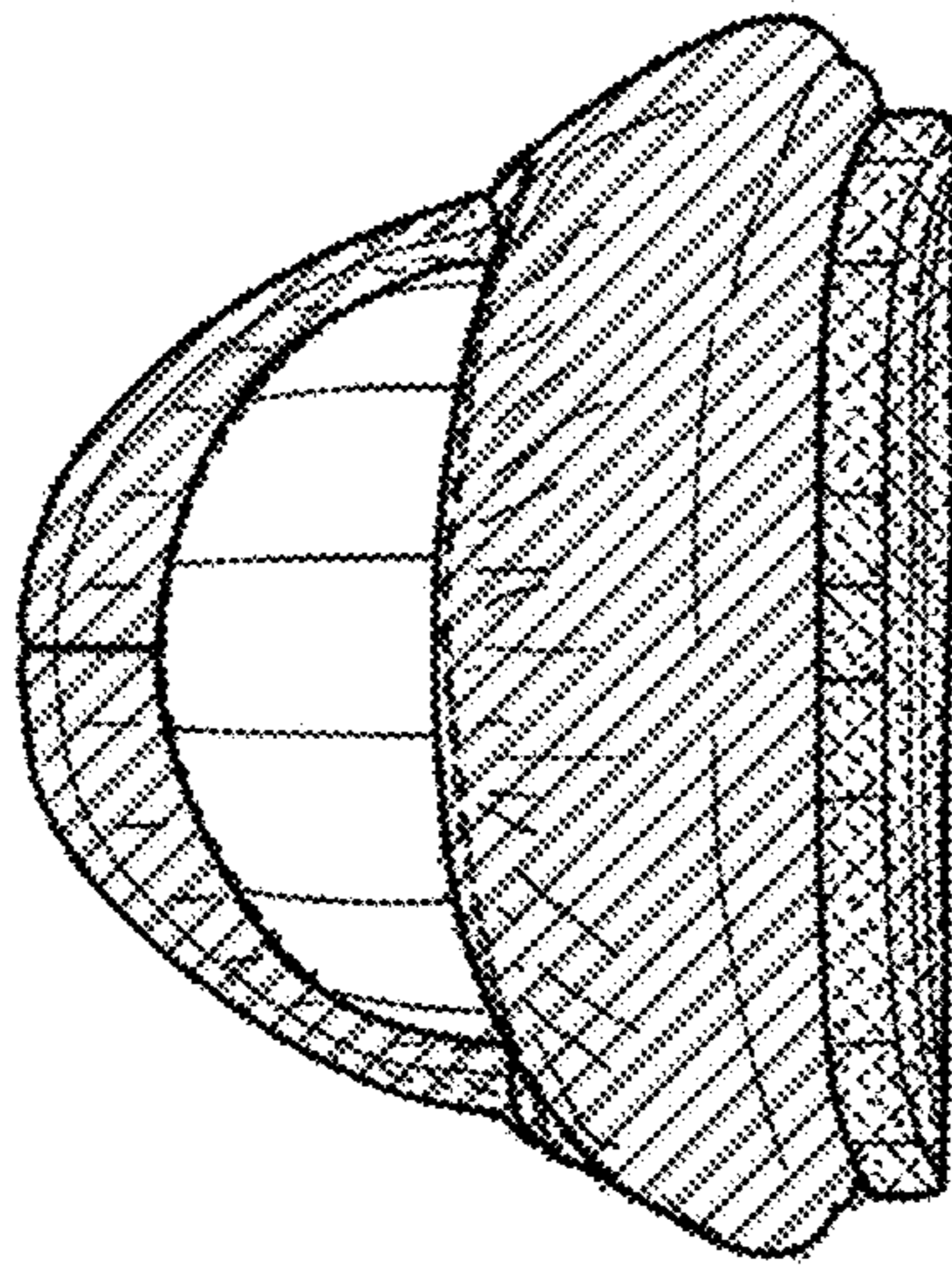

FIG. 76

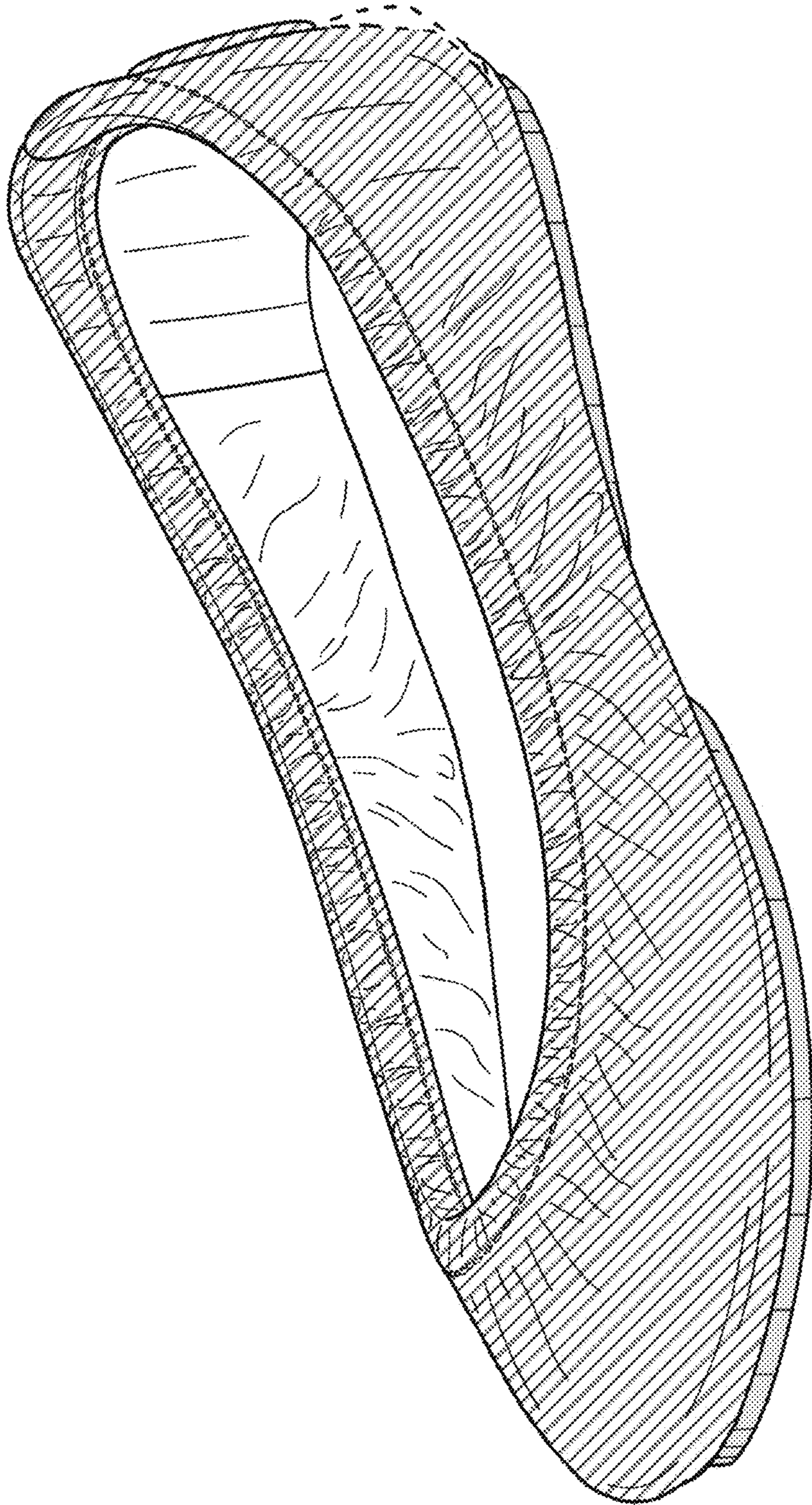

FIG. 78

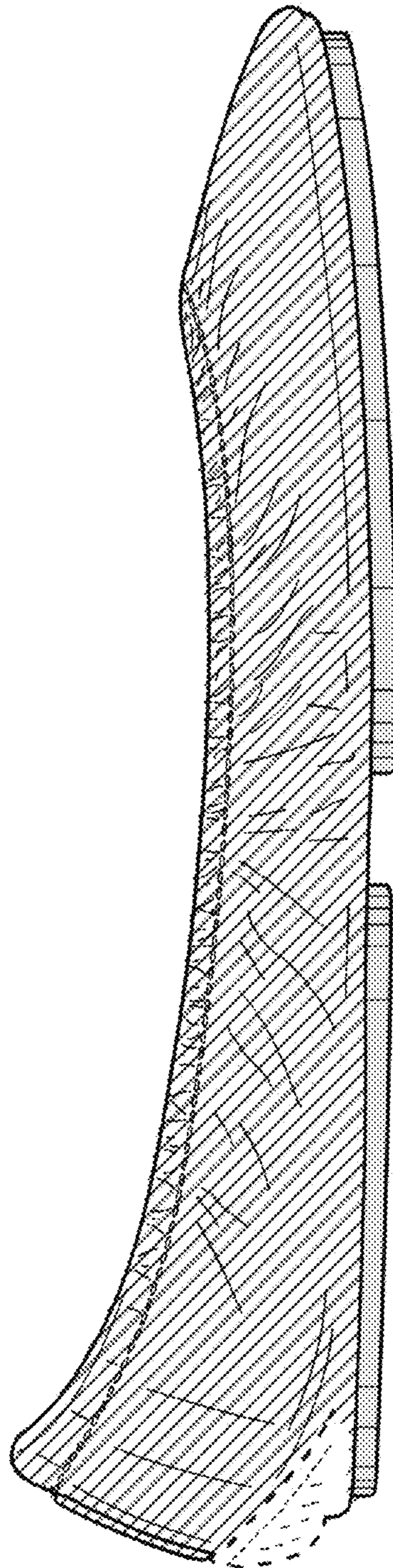

FIG. 79

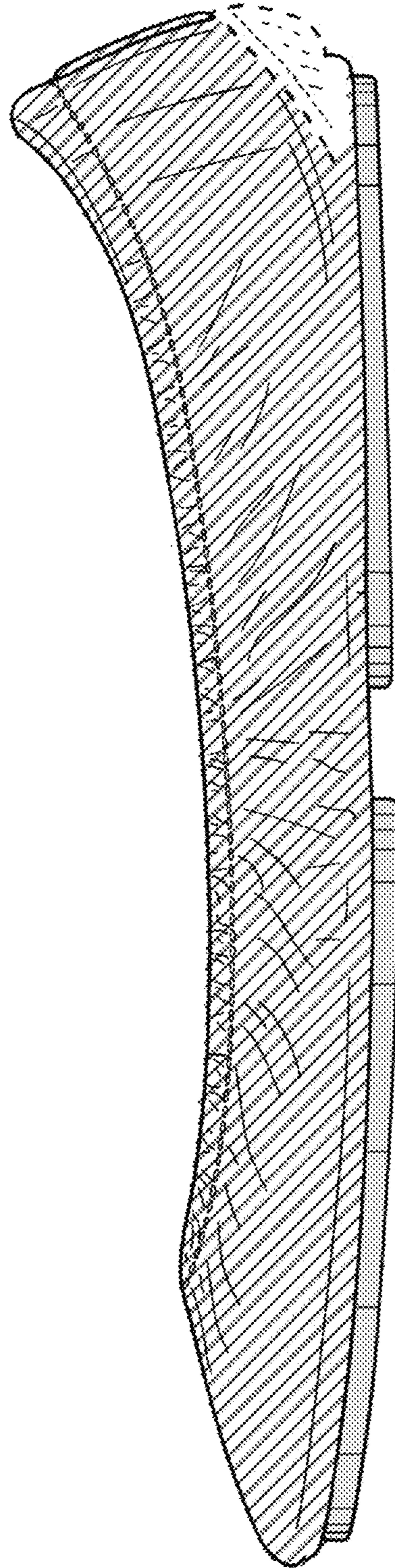

FIG. 80

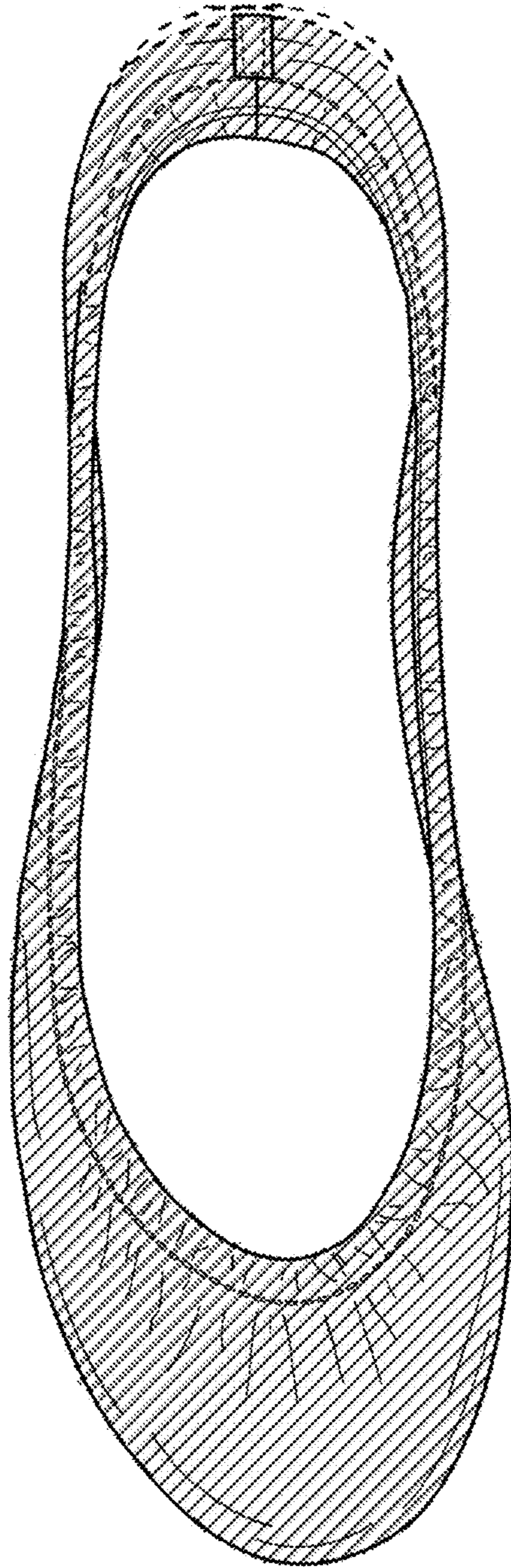

FIG. 81

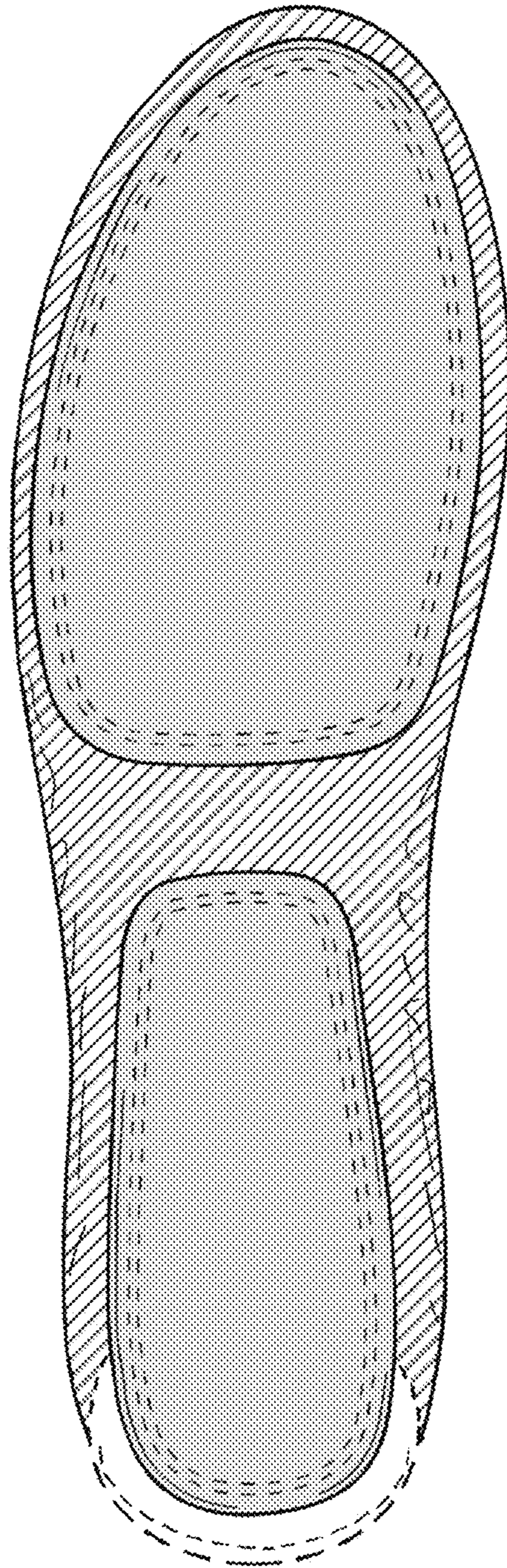

FIG. 82

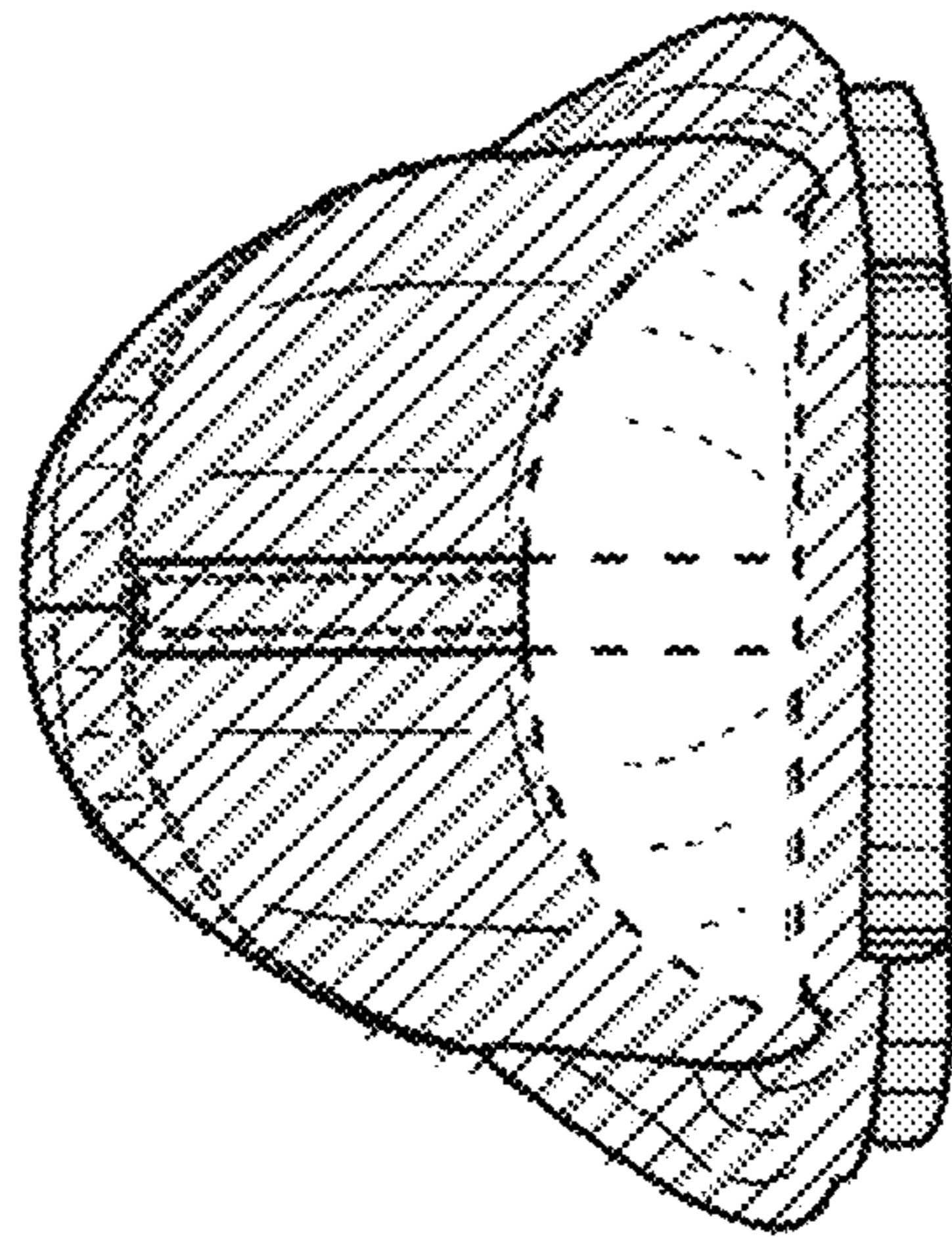

FIG. 84

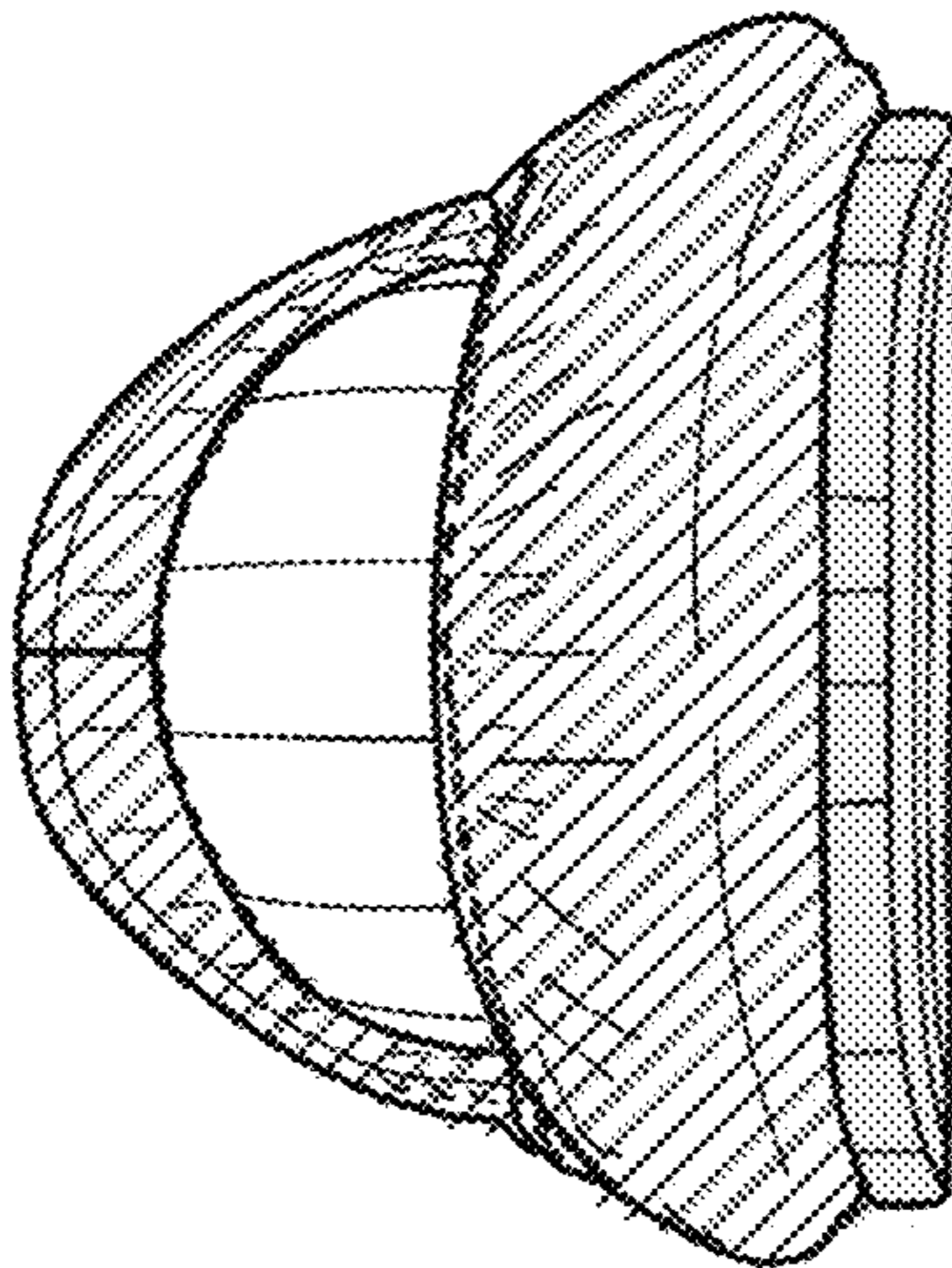

FIG. 83

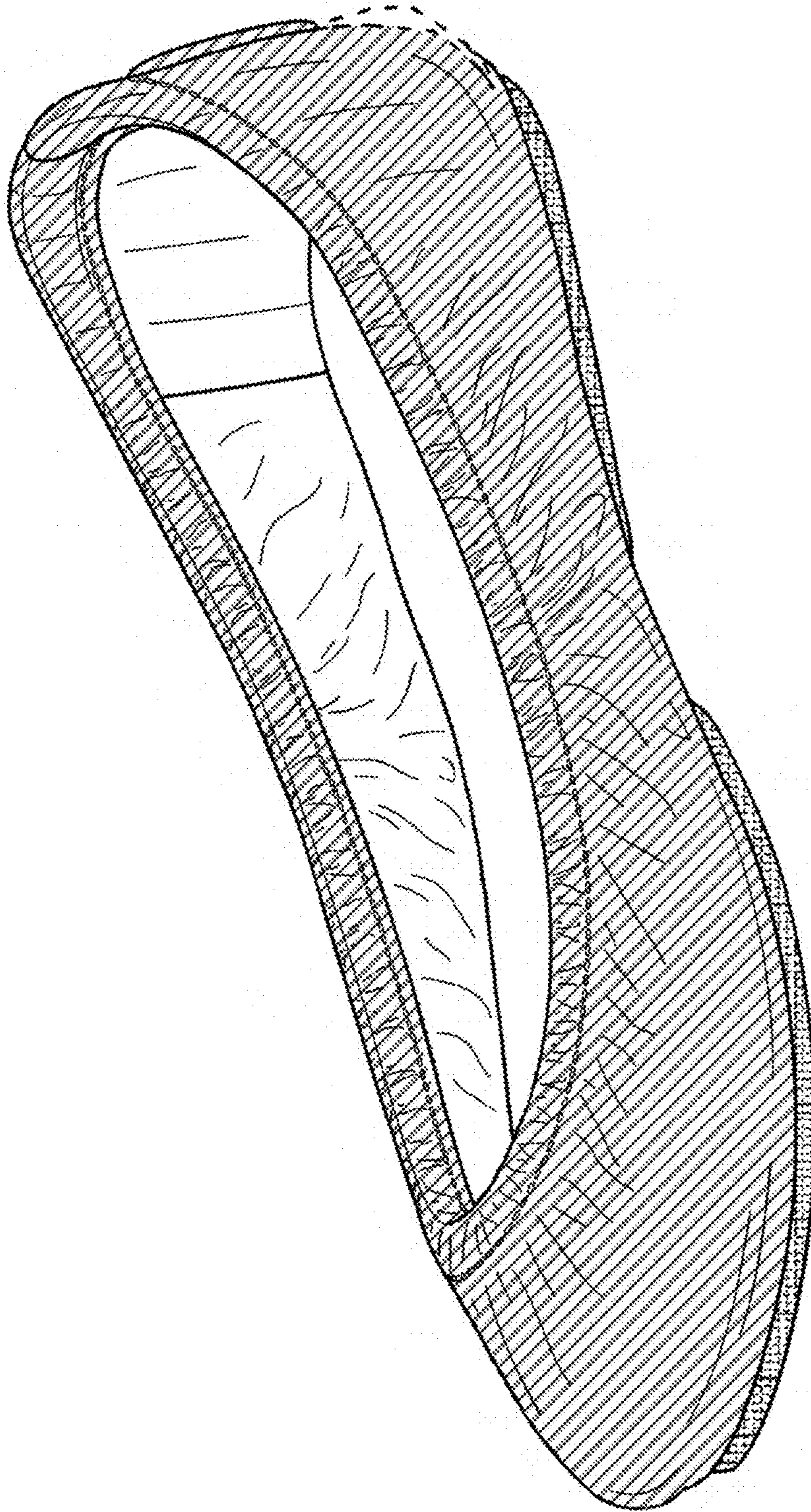

FIG. 85

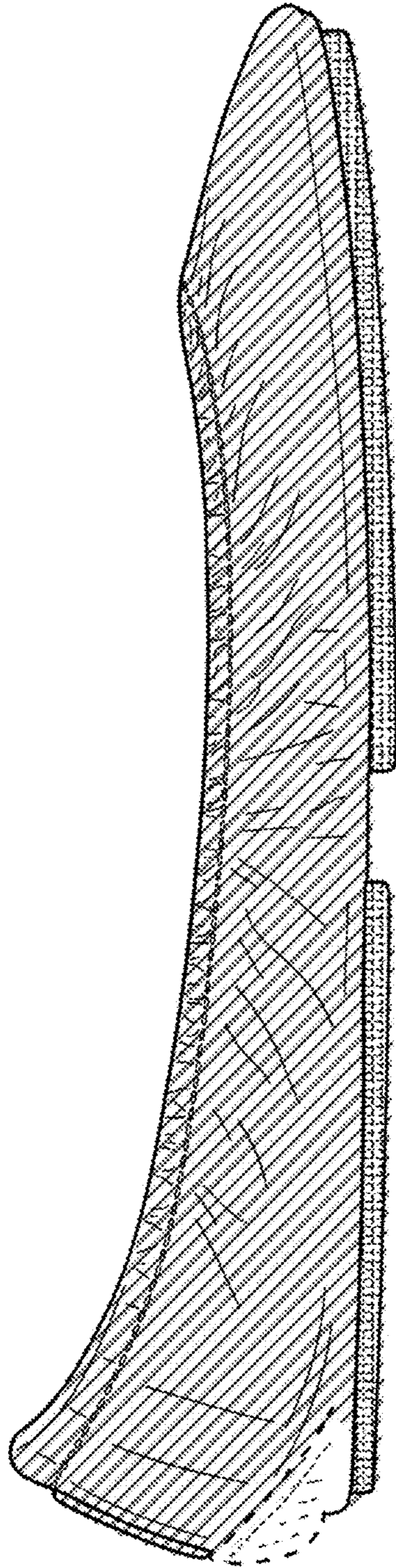

FIG. 86

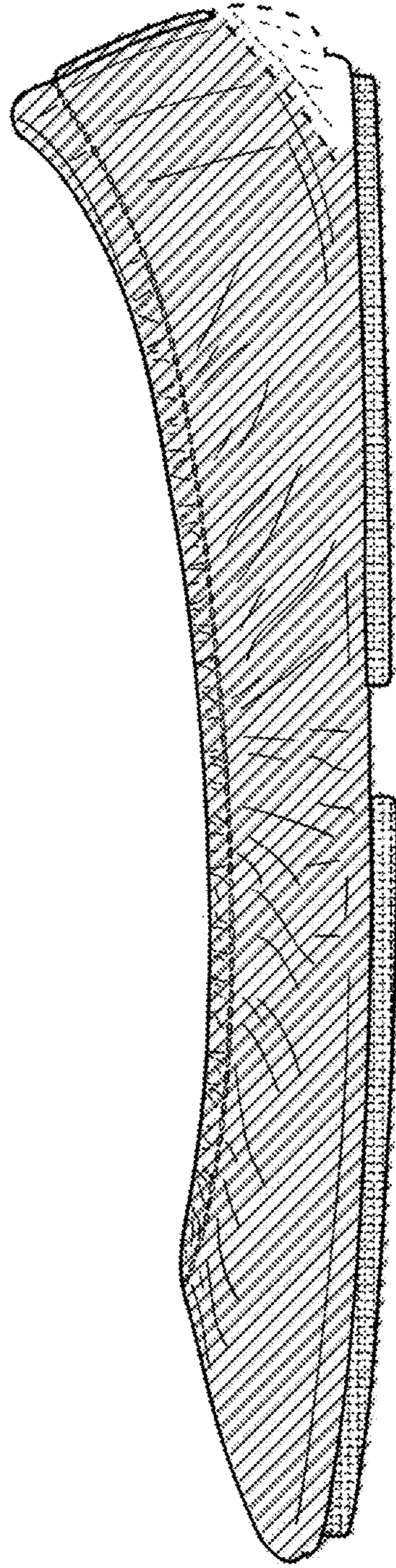

FIG. 87

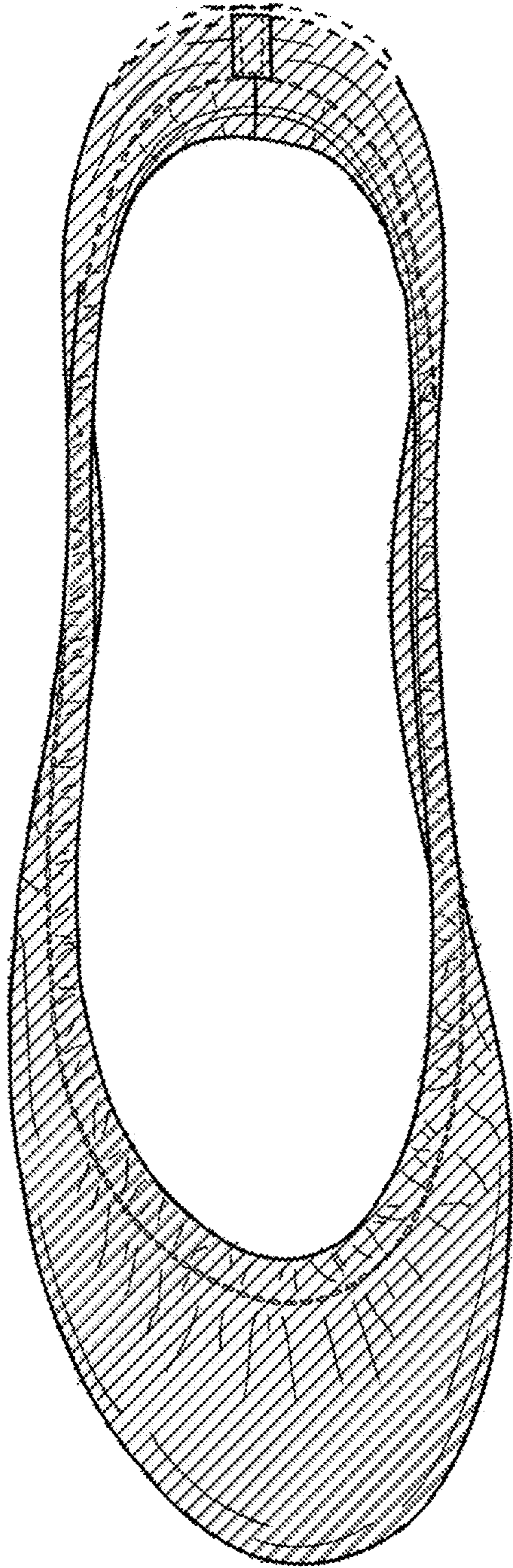

FIG. 88

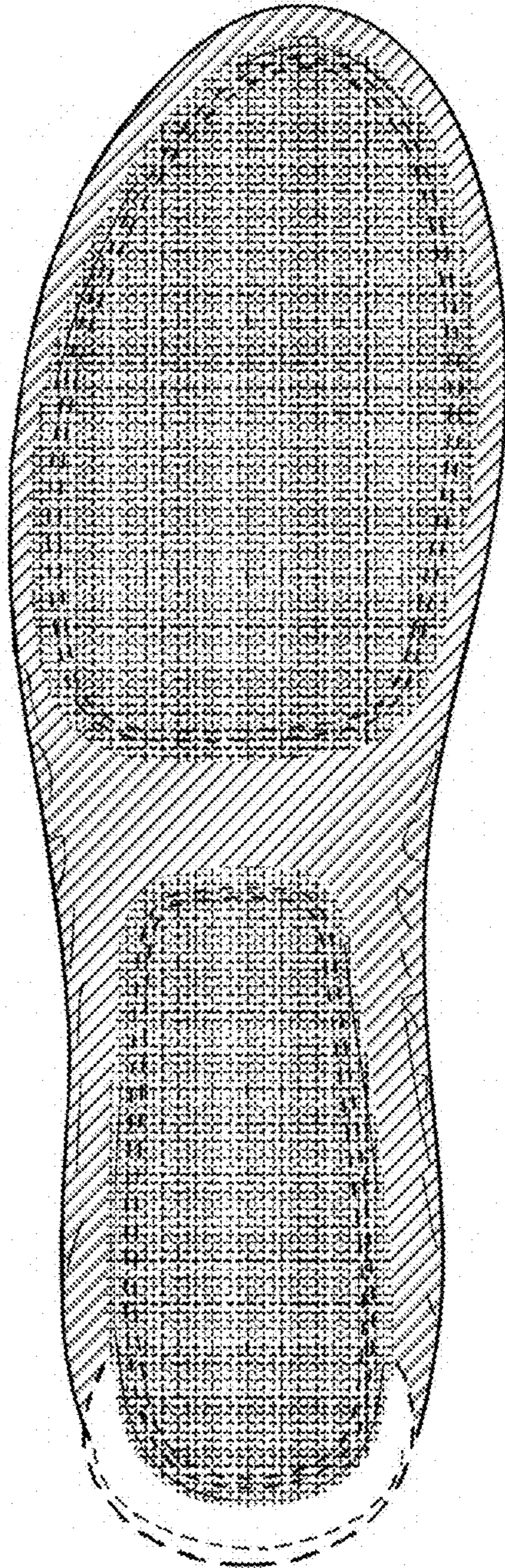

FIG. 89

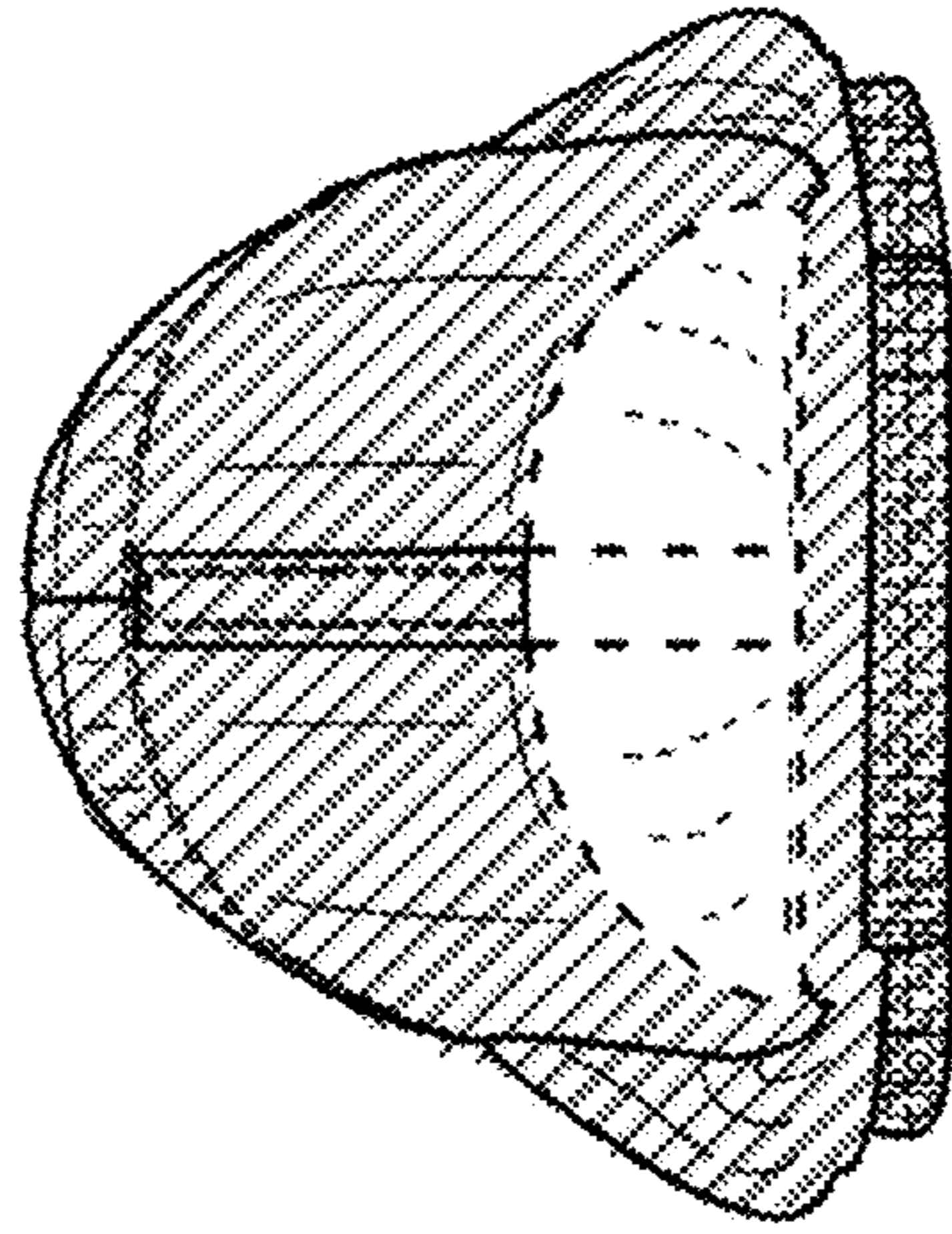

FIG. 91

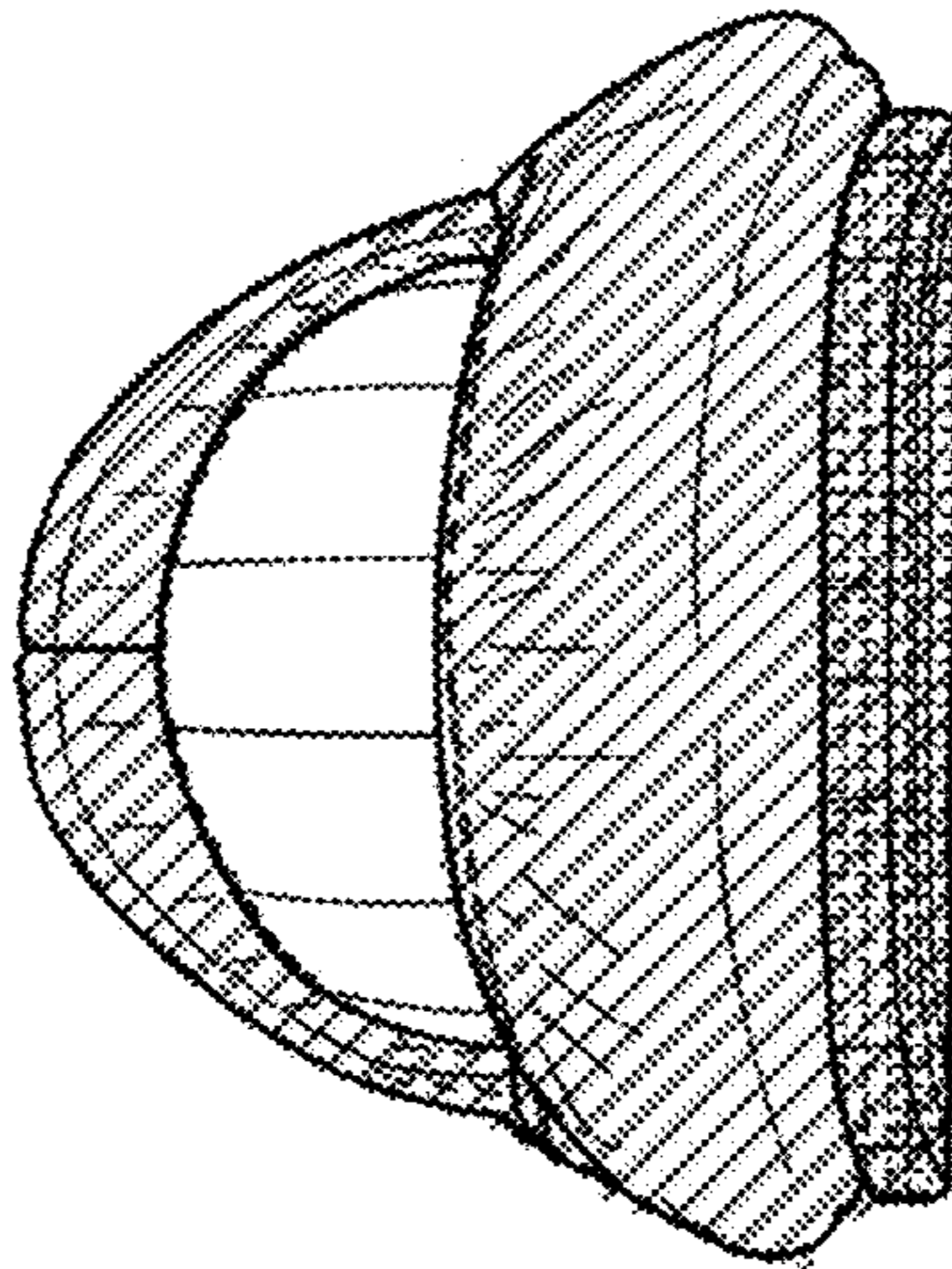

FIG. 90

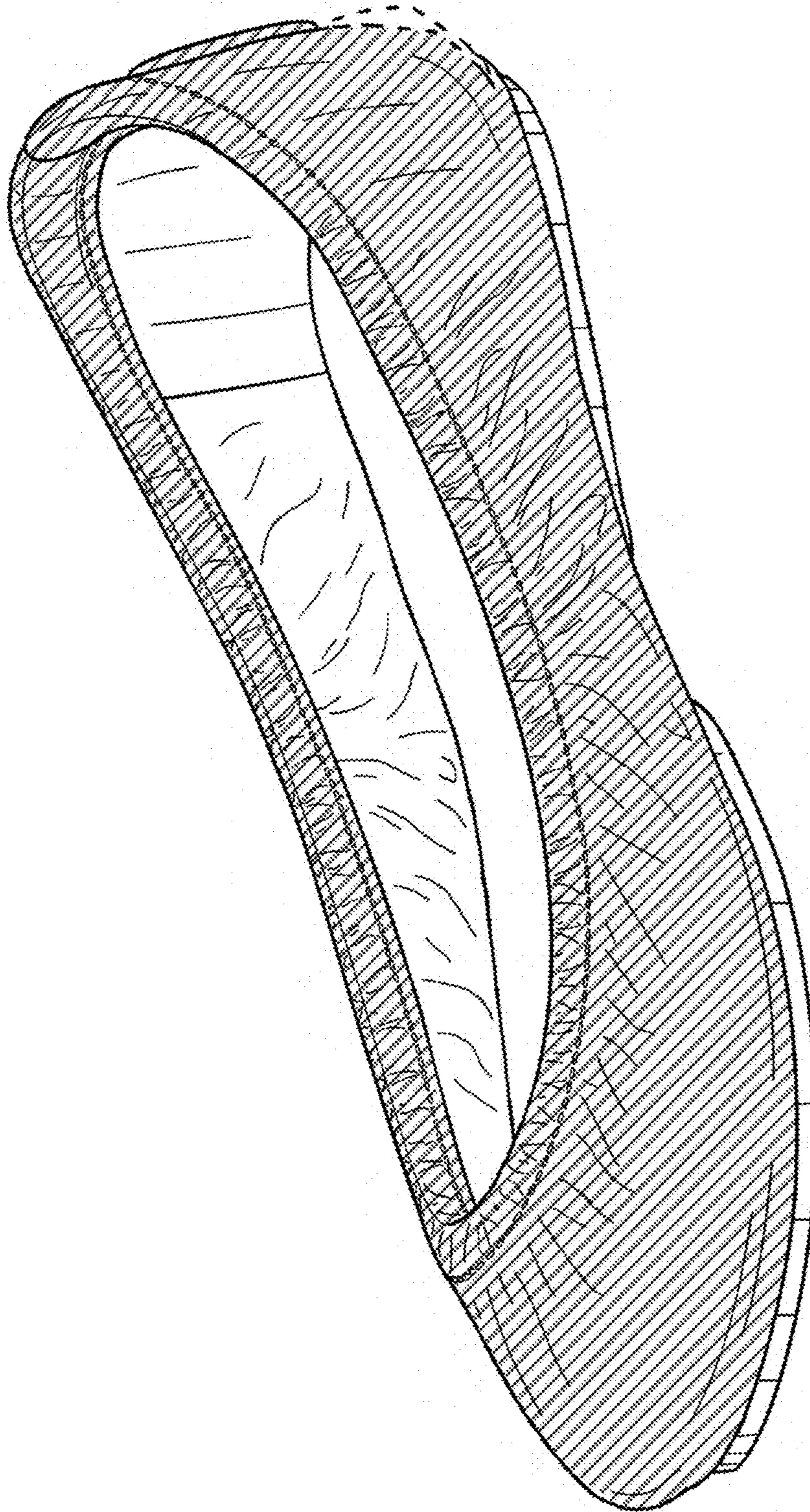

FIG. 92

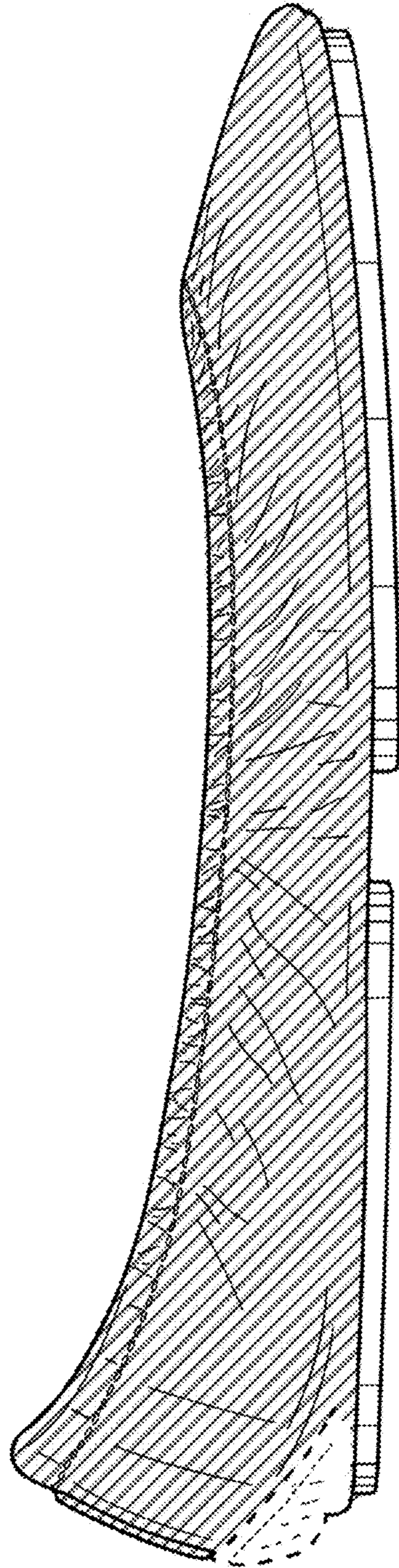

FIG. 93

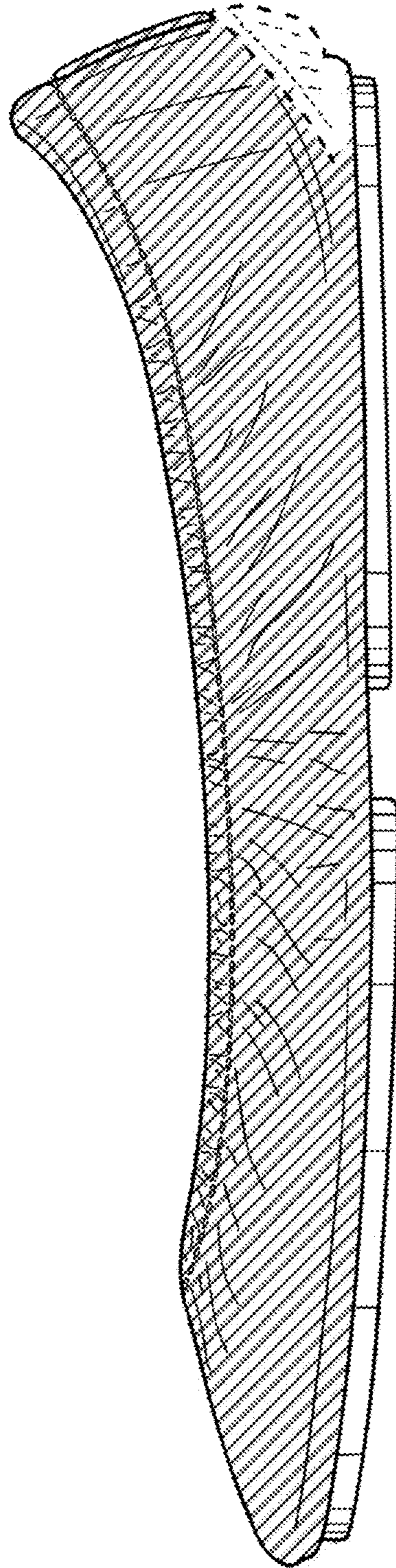

FIG. 94

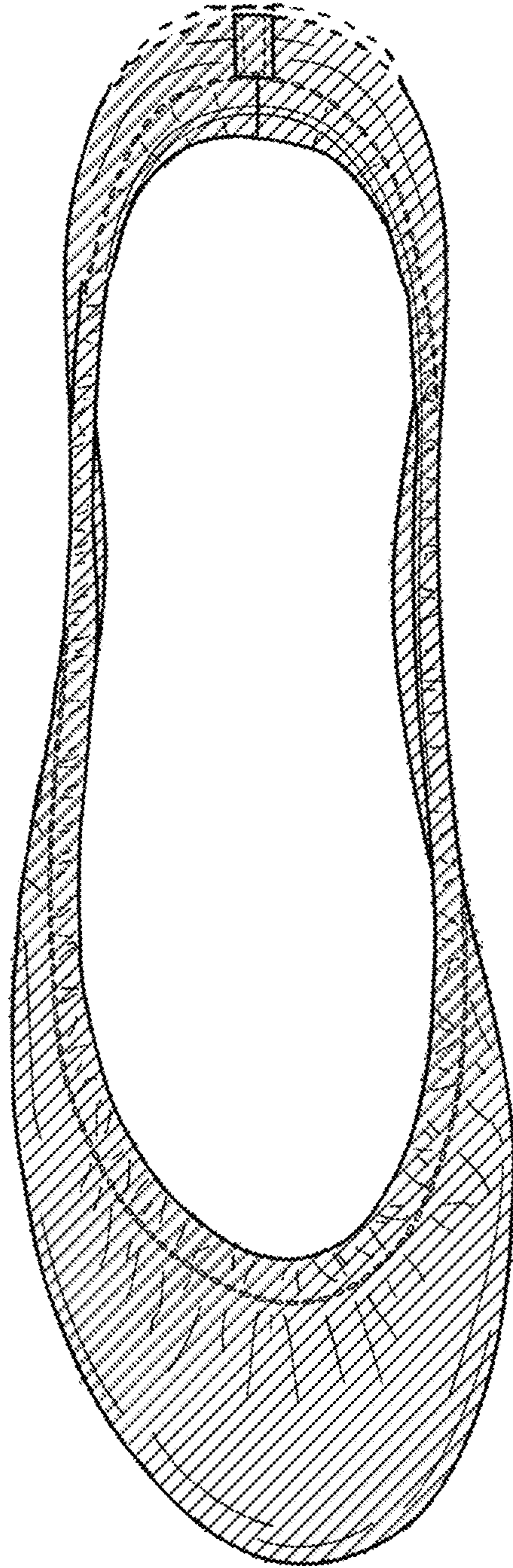

FIG. 95

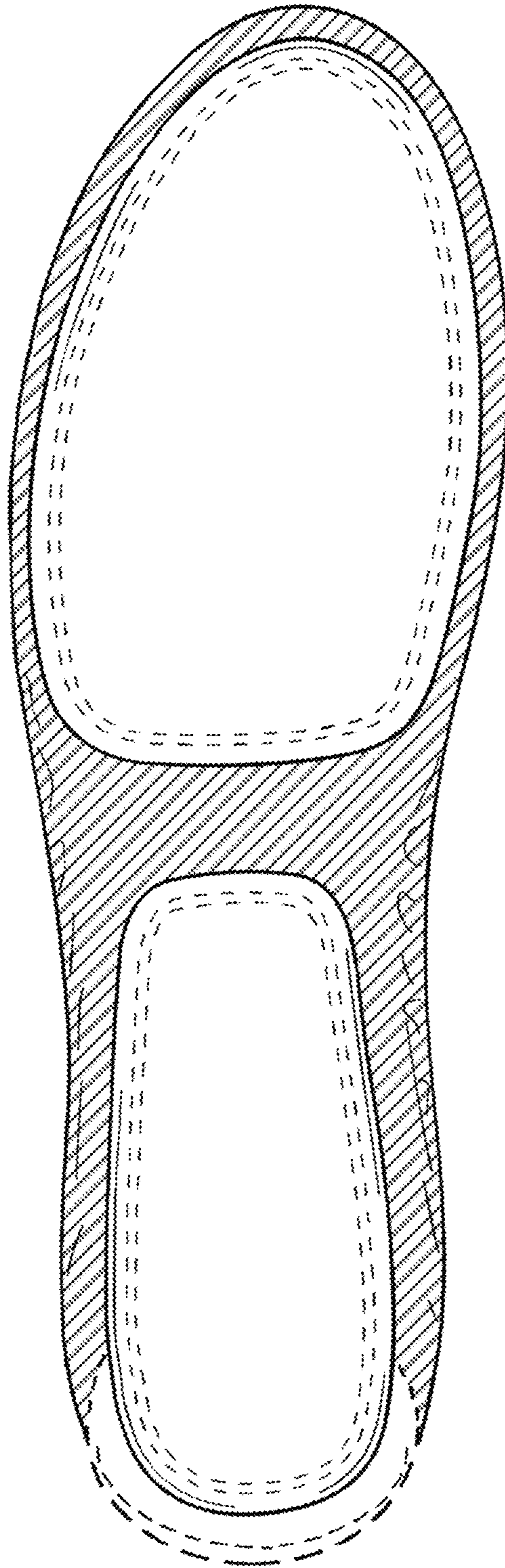

FIG. 96

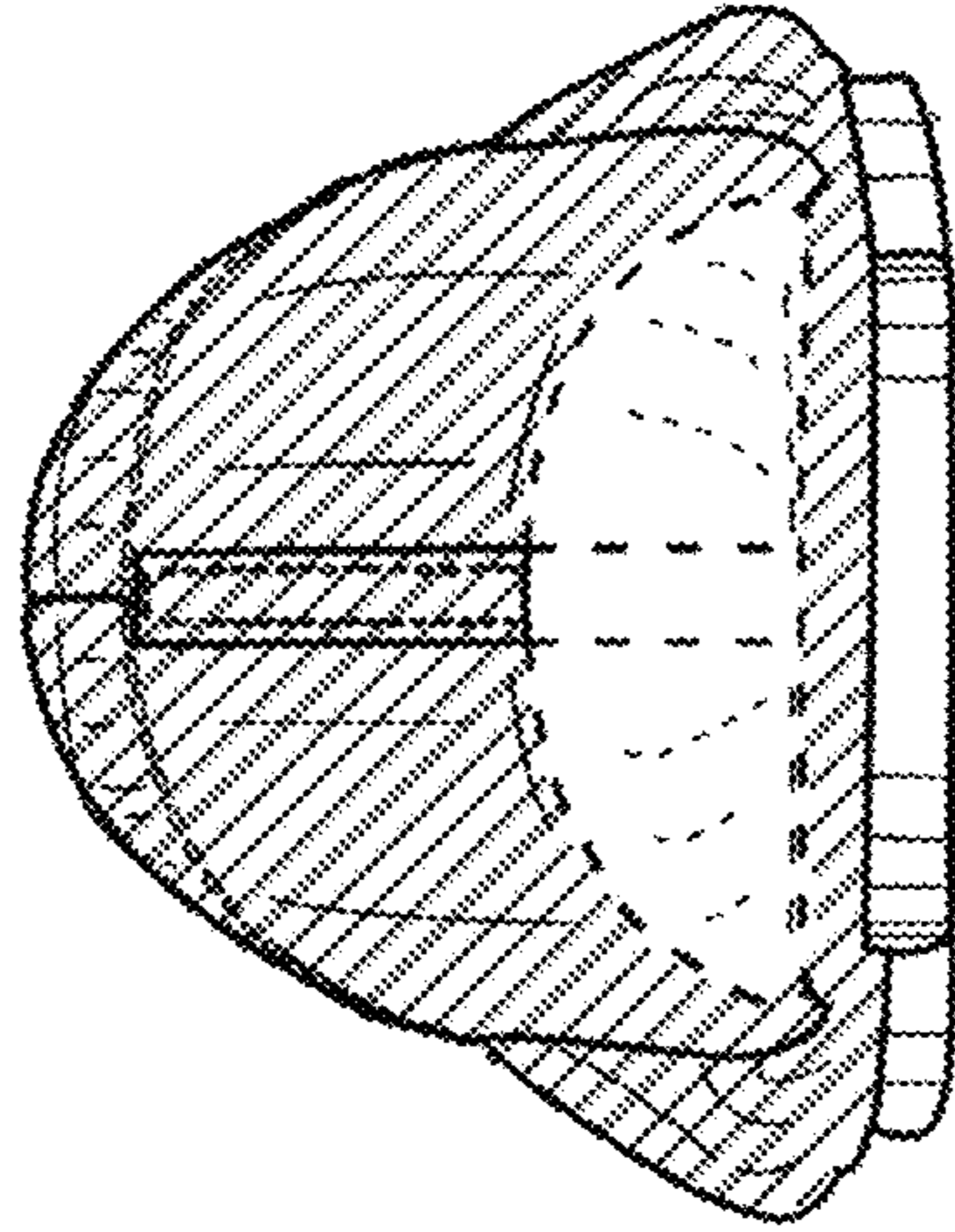

FIG. 97

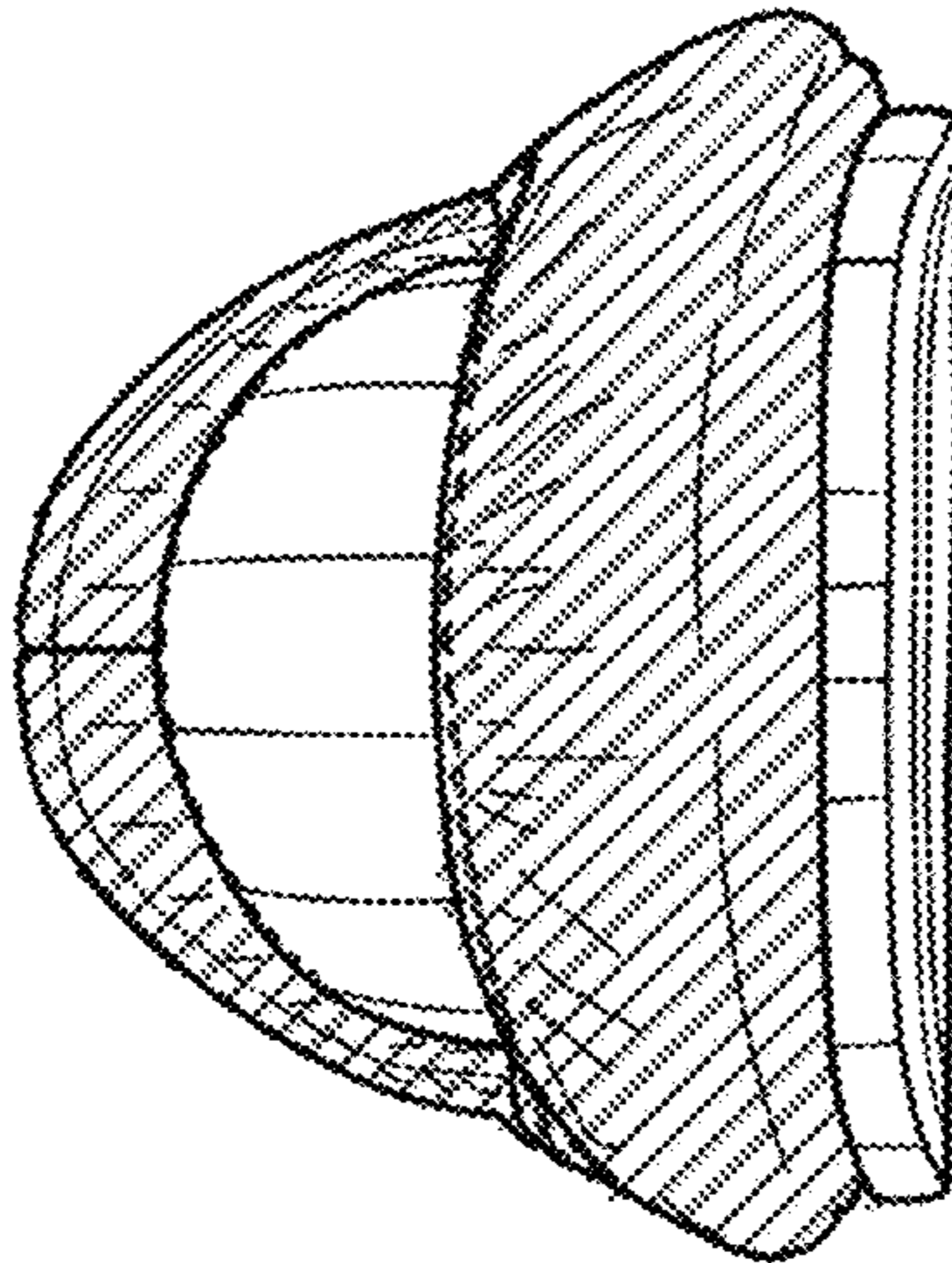

FIG. 98