



US00D890981S

(12) **United States Design Patent**
Toikka

(10) **Patent No.:** **US D890,981 S**
(45) **Date of Patent:** **** Jul. 21, 2020**

(54) **LAMP**
(71) Applicant: **Magis S.p.A.**, Torre di Mosto (IT)
(72) Inventor: **Oiva Toikka**, Helsinki (FI)
(**) Term: **15 Years**
(21) Appl. No.: **29/666,849**
(22) Filed: **Oct. 16, 2018**

D446,321 S * 8/2001 Lin D26/1
D479,623 S * 9/2003 Fu D26/118
D500,952 S * 1/2005 Moore D9/504
D563,593 S * 3/2008 Audrito D26/104
D615,818 S * 5/2010 Jansen D7/510
D659,024 S * 5/2012 Borghesi D9/688
D724,254 S * 3/2015 Sun D26/101
D744,695 S * 12/2015 Kwok D26/135
D796,725 S * 9/2017 Recker D26/104
D814,688 S * 4/2018 Chang D26/118
D826,464 S * 8/2018 Hendifar D26/111
D830,622 S * 10/2018 Galekop D26/118
D839,096 S * 1/2019 Fux D9/503

(30) **Foreign Application Priority Data**

May 14, 2018 (EM) 005268141-0005

(51) **LOC (12) Cl.** **26-05**

(52) **U.S. Cl.**
USPC **D26/93**

(58) **Field of Classification Search**

USPC D26/1, 21, 22, 24, 40, 51, 79, 83, 93,
D26/118, 123, 124, 128, 130, 135;
D6/329; D14/172; D13/184; D9/681,
D9/763, 767, 772; D24/100, 101, 104
CPC .. F21S 6/002; F21S 6/004; F21S 6/005; F21S
8/06; F21V 1/00; F21V 1/02; F21V 1/04;
F21V 15/01; F21V 15/02; F21V 15/012;
F21V 3/00; F21V 3/02; F21V 21/06;
F21V 21/08

See application file for complete search history.

(56) **References Cited**

U.S. PATENT DOCUMENTS

D261,048 S * 9/1981 Price D26/24
D298,573 S * 11/1988 Komamura D26/37
D411,322 S * 6/1999 Suzuki D20/10

* cited by examiner

Primary Examiner — Wan Laymon

Assistant Examiner — Clint A Samuel

(74) *Attorney, Agent, or Firm* — Themis Law

(57) **CLAIM**

The ornamental design for a lamp, as shown and described.

DESCRIPTION

FIG. 1 is a perspective view of a lamp showing my new design;

FIG. 2 is a front elevational view thereof;

FIG. 3 is a rear elevational view thereof;

FIG. 4 is a right side elevational view thereof;

FIG. 5 is a left side elevational view thereof;

FIG. 6 is a top plan view thereof; and,

FIG. 7 is a bottom view thereof.

The broken line showing in the drawings is included for the purpose of illustrating unclaimed portions of the lamp and forms no part of the claimed design.

1 Claim, 4 Drawing Sheets

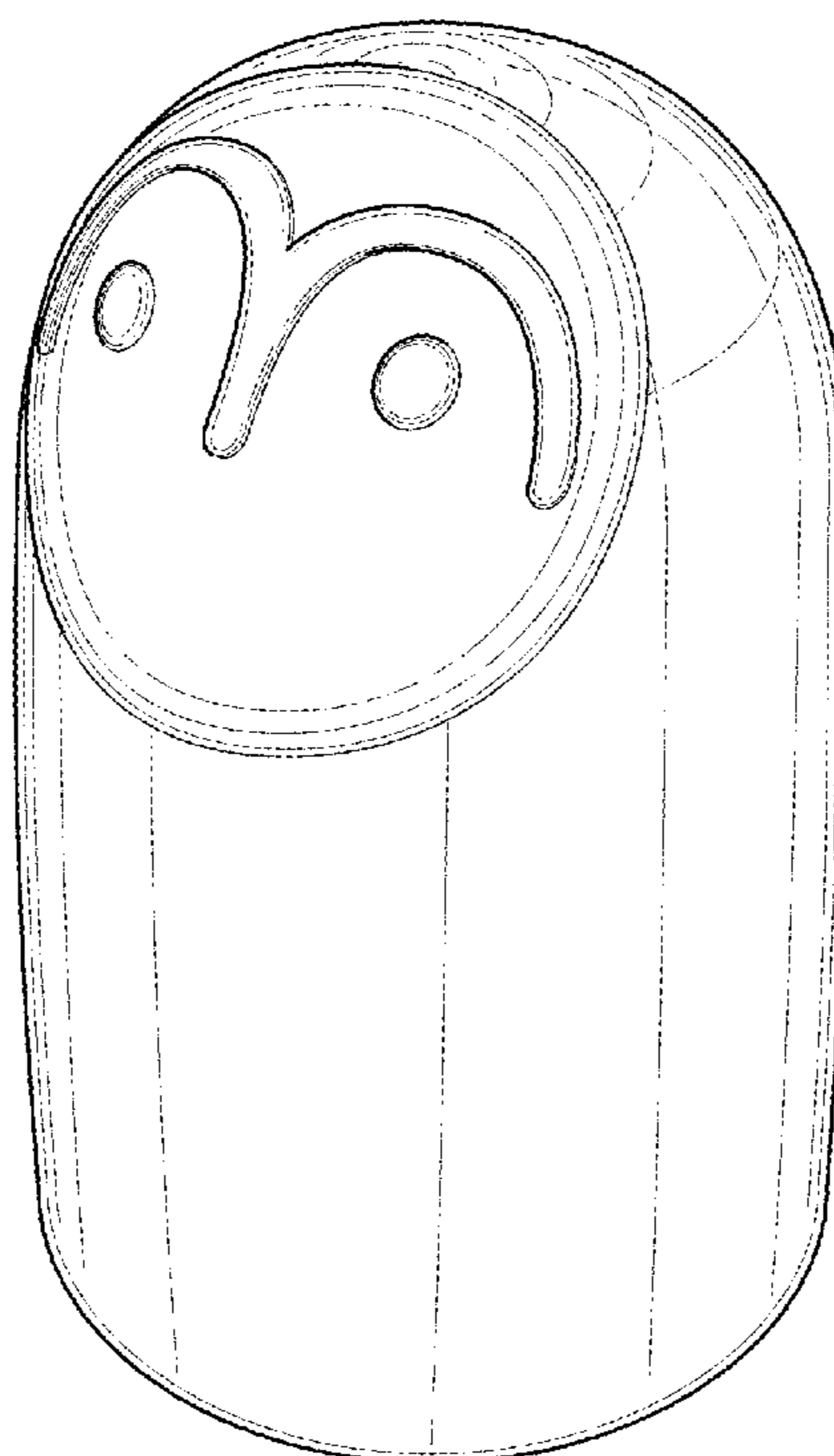

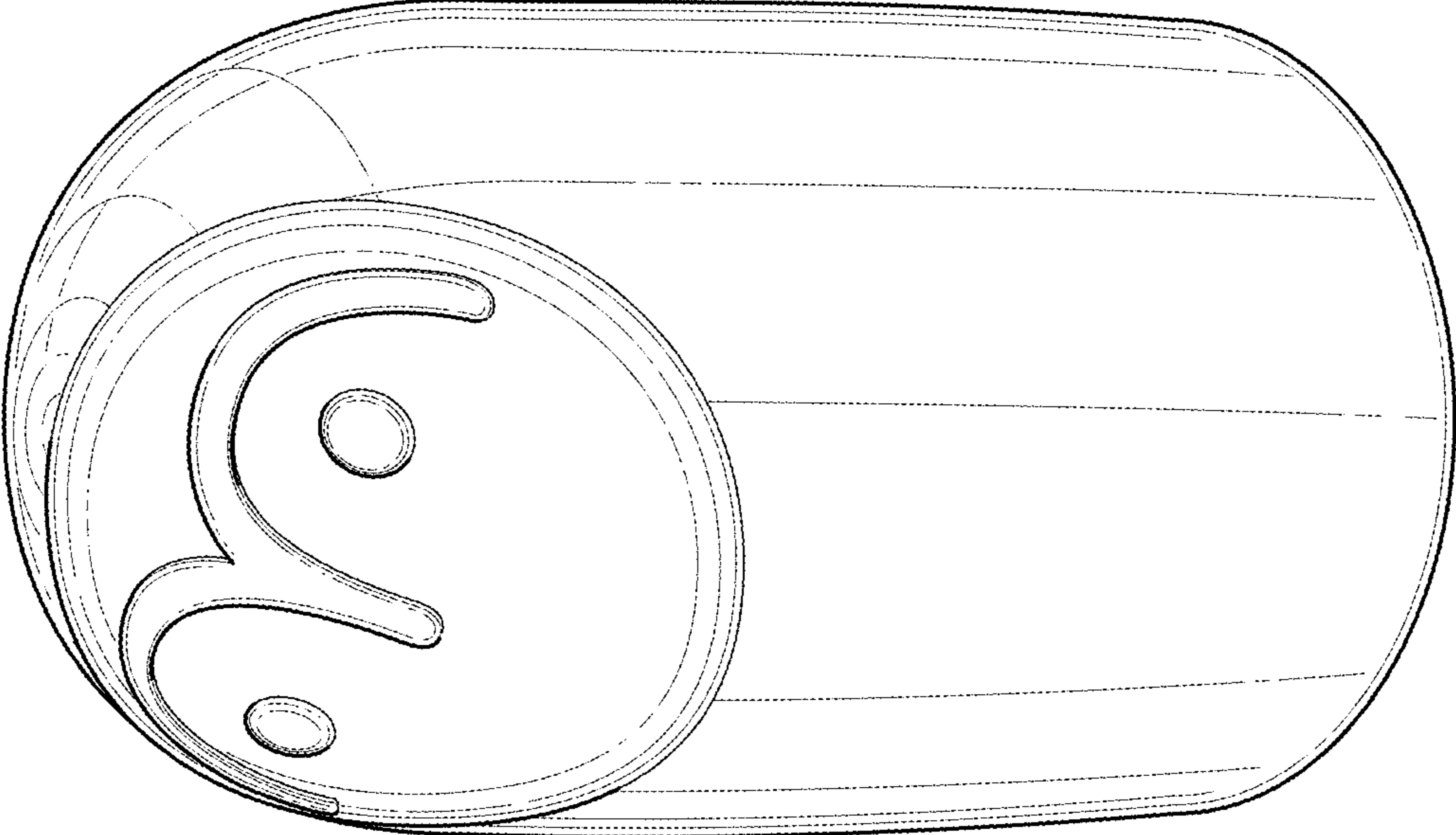

FIG. 1

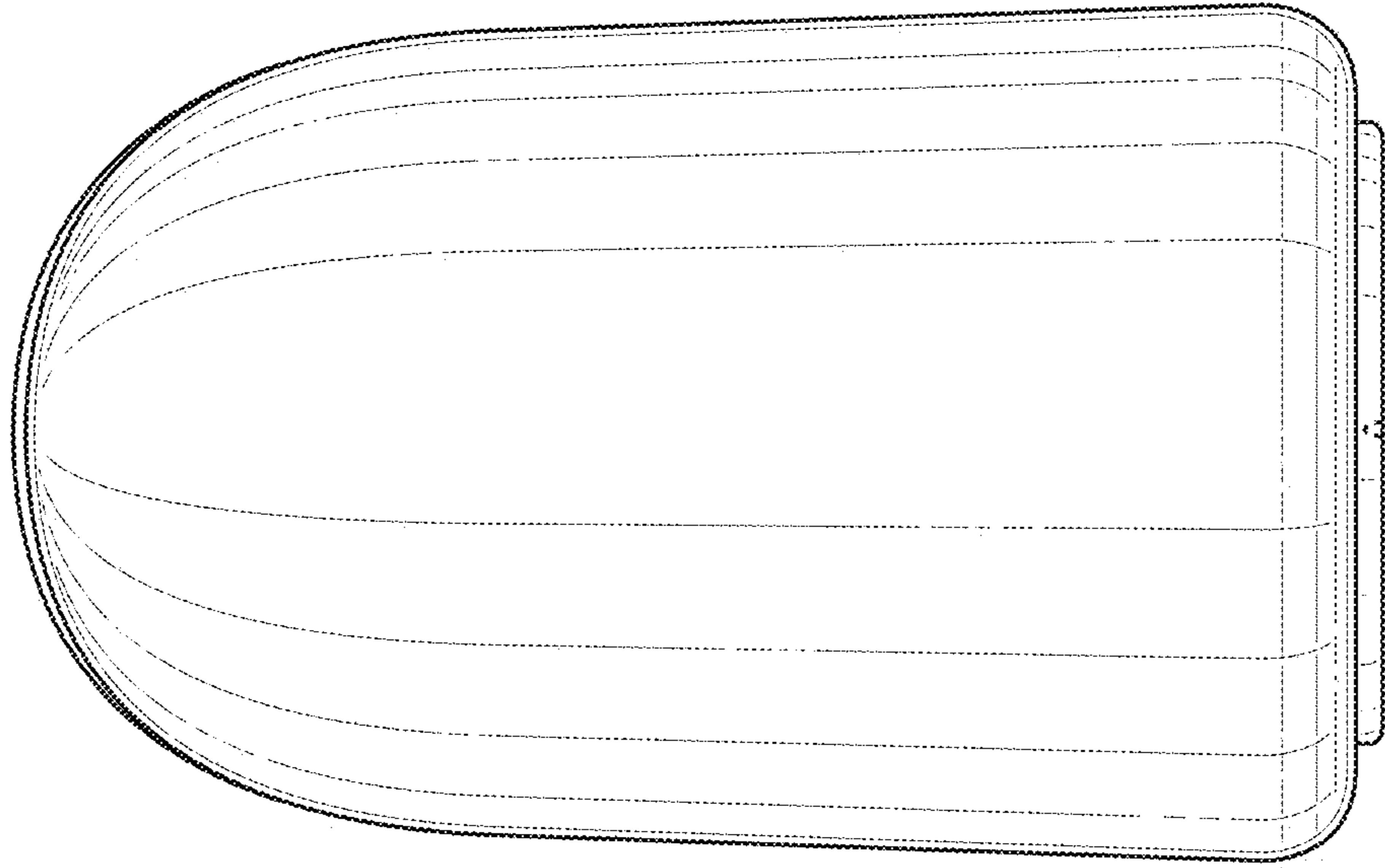

FIG. 3

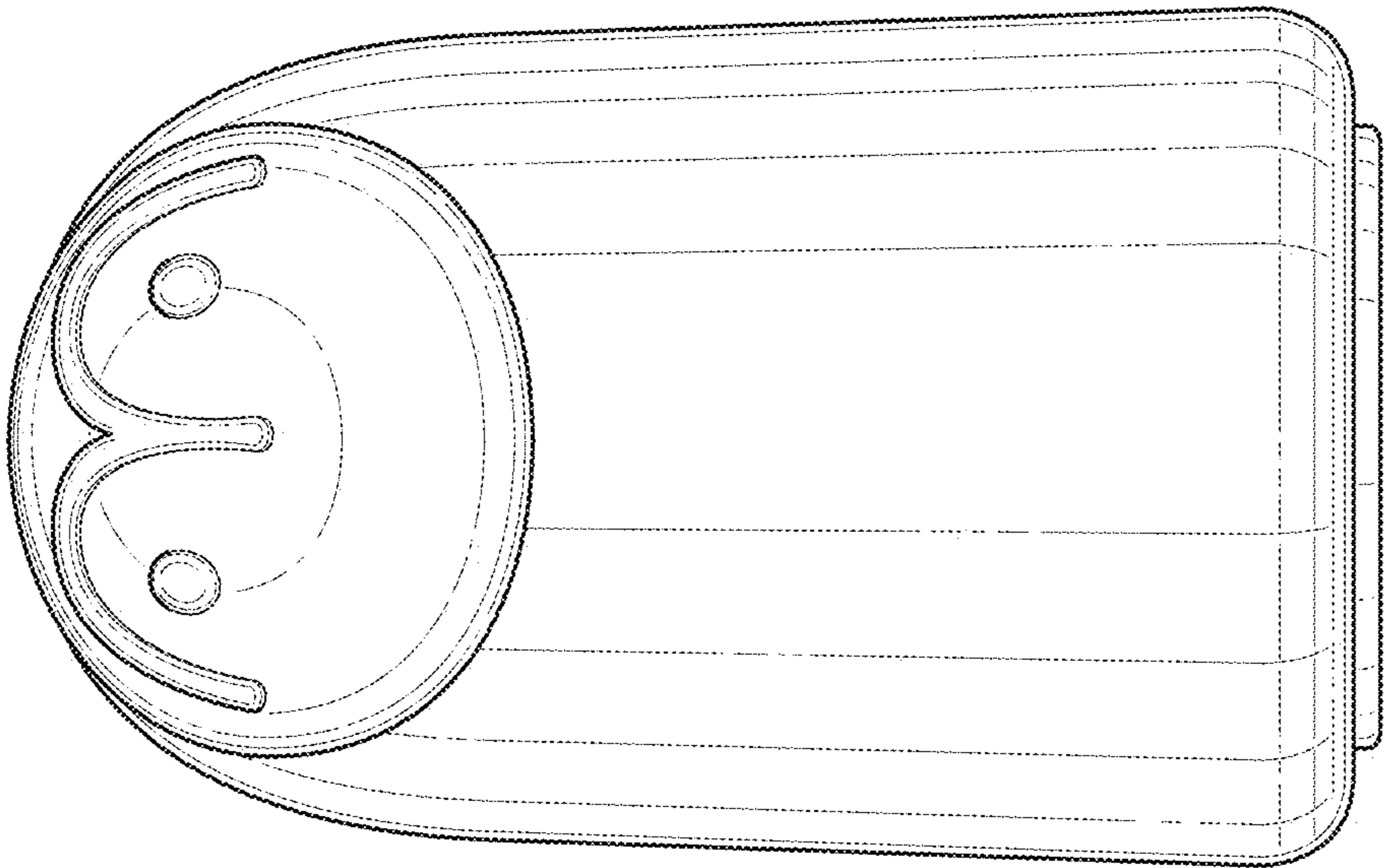

FIG. 2

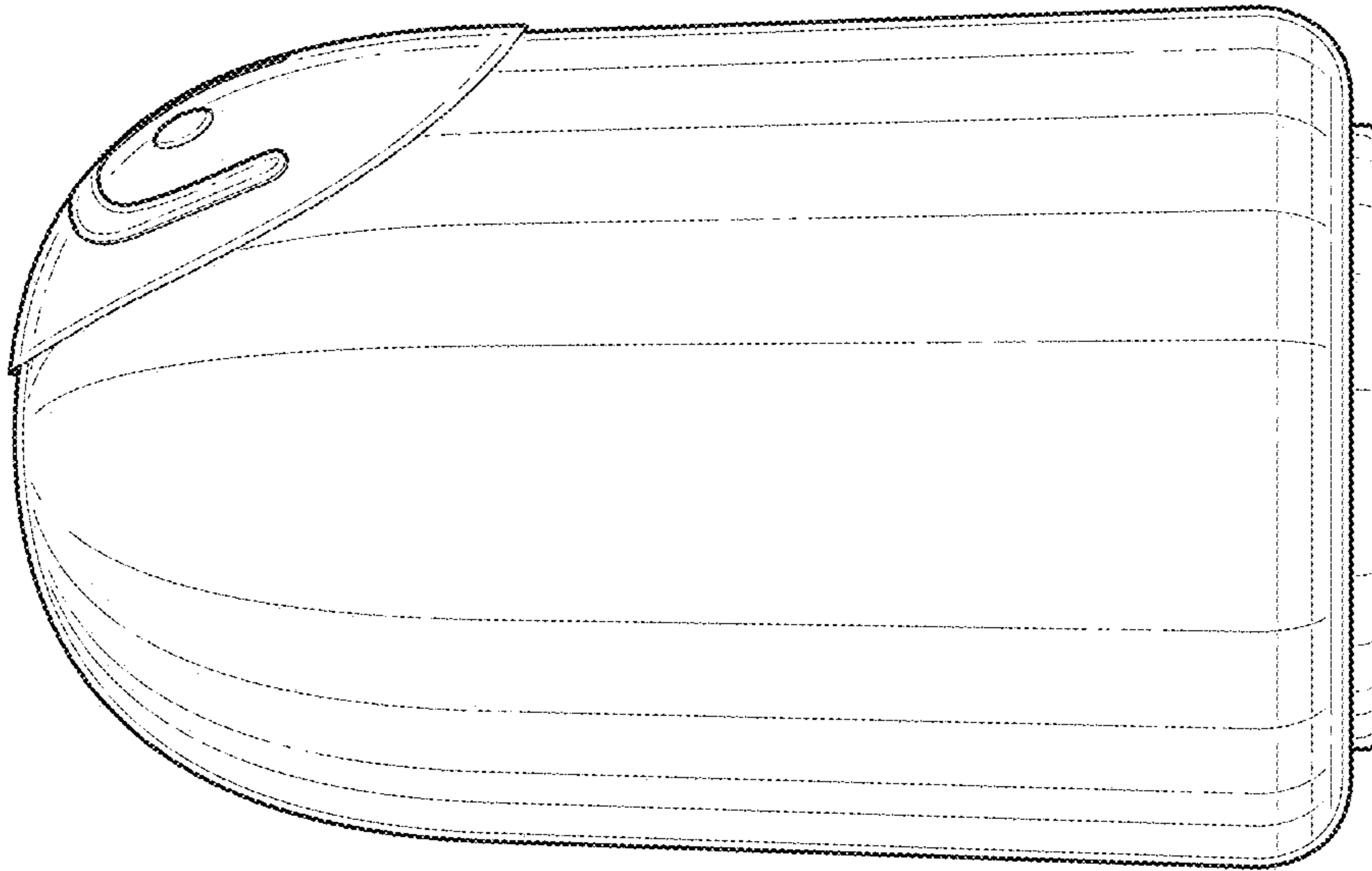

FIG. 5

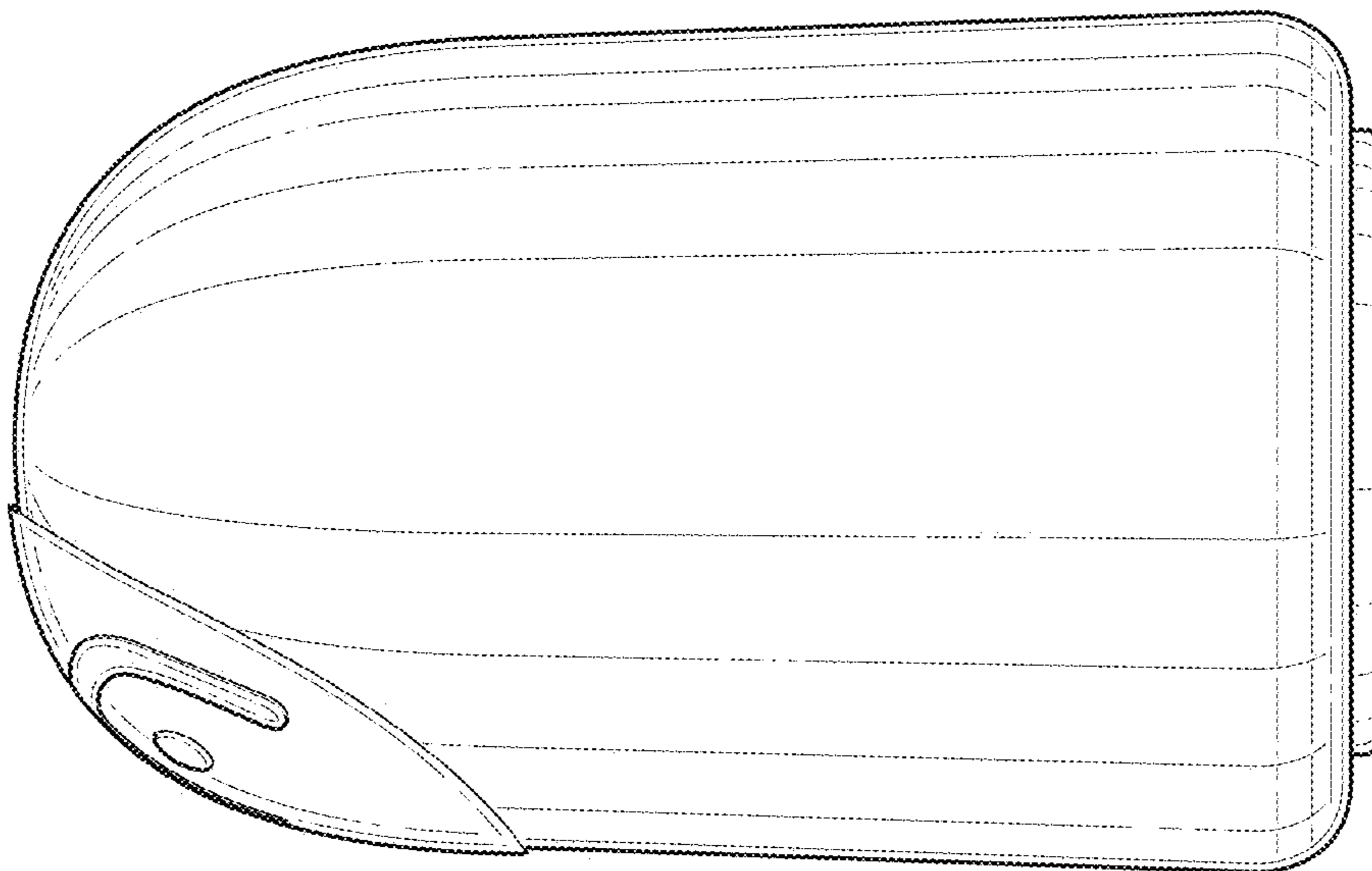

FIG. 4

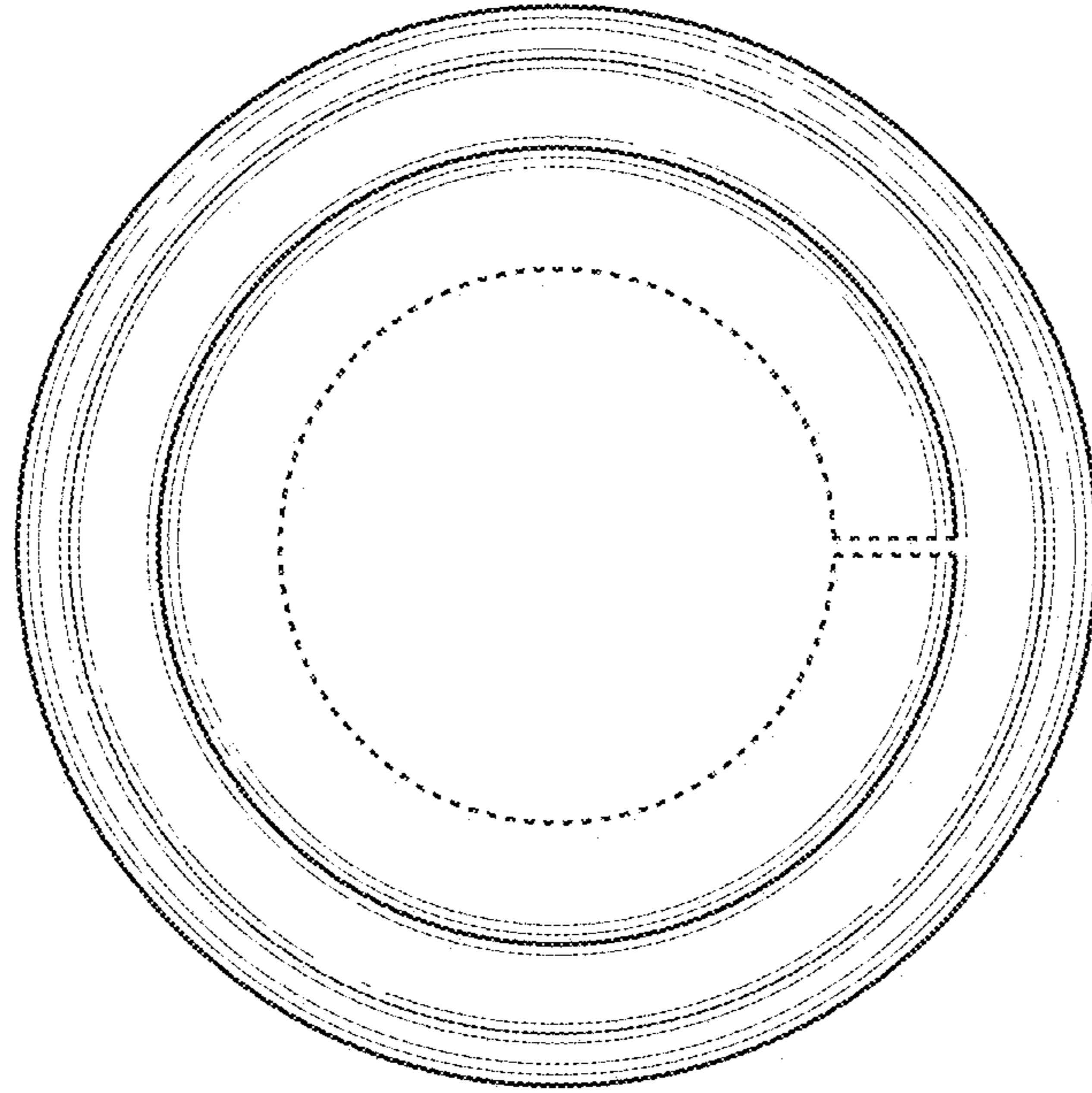

FIG. 6

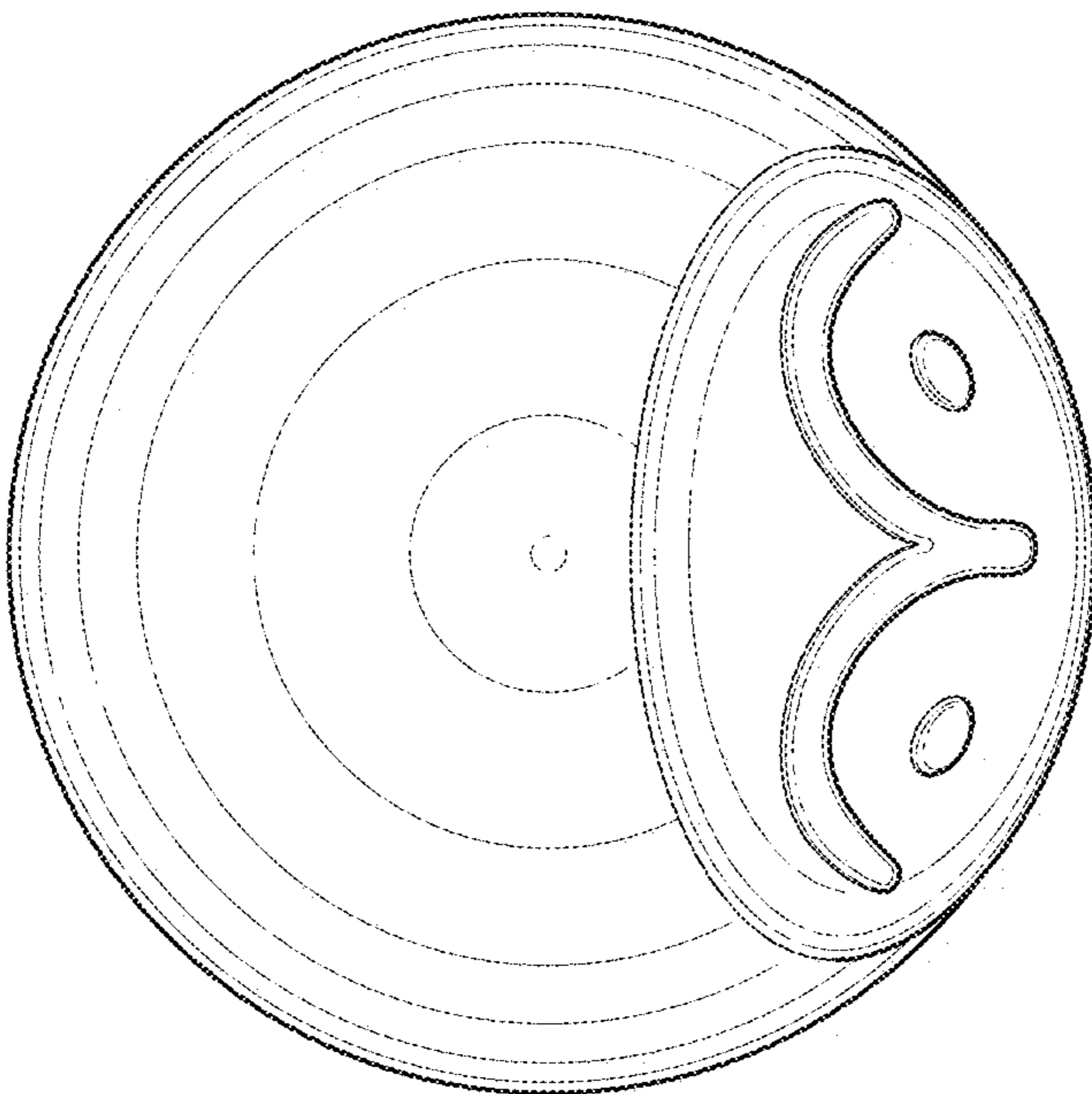

FIG. 7