



US00D890936S

(12) **United States Design Patent** (10) **Patent No.:** **US D890,936 S**  
**Hicken et al.** (45) **Date of Patent:** **\*\* Jul. 21, 2020**

- (54) **THERAPEUTIC ELASTIC SPORTS TAPE**
- (71) Applicant: **Blacktop Plus, LLC**, Carrollton, TX (US)
- (72) Inventors: **Matthew Hicken**, Frisco, TX (US);  
**Christian Hicken**, Prosper, TX (US);  
**Nathan Ellison**, Cedar Hills, UT (US);  
**Nicholas Hicken**, Prosper, TX (US);  
**Steven Silvey**, Dallas, TX (US)
- (73) Assignee: **BLACKTOP PLUS, LLC**, Carrollton, TX (US)
- (\*\*) Term: **15 Years**
- (21) Appl. No.: **29/649,123**
- (22) Filed: **May 25, 2018**
- (51) **LOC (12) Cl.** ..... **24-04**
- (52) **U.S. Cl.**  
USPC ..... **D24/189**
- (58) **Field of Classification Search**  
USPC ..... D24/112, 124–128, 132, 133, 185–193,  
D24/199, 200, 206, 209, 210, 212–215;  
(Continued)

(56) **References Cited**

**U.S. PATENT DOCUMENTS**

2,579,409 A 12/1951 Clark  
3,523,859 A 8/1970 Komp  
(Continued)

**FOREIGN PATENT DOCUMENTS**

EP 0392845 A2 10/1990  
EP 0392845 A3 9/1992

**OTHER PUBLICATIONS**

Youtube. Blacktop+ Informational by Nick Hicken. May 22, 2018.  
[https://www.youtube.com/watch?v=LR\\_mnAd0ERA](https://www.youtube.com/watch?v=LR_mnAd0ERA) (Year: 2018).\*

*Primary Examiner* — Darcey E Gottschalk  
(74) *Attorney, Agent, or Firm* — Goodhue, Coleman & Owens, P.C.

(57) **CLAIM**

The ornamental design for therapeutic elastic sports tape, as shown and described.

**DESCRIPTION**

FIG. 1 is a perspective view of therapeutic elastic sports tape;  
FIG. 2 is another perspective view thereof in use;  
FIG. 3 is a top view thereof;  
FIG. 4 is a bottom view thereof with shading for illustrating adhesive;  
FIG. 5 is a right side view thereof with the left side view being a mirror image;  
FIG. 6 is a front view thereof;  
FIG. 7 is a back view thereof;  
FIG. 8 is a perspective view of another therapeutic elastic sports tape;  
FIG. 9 is another perspective view thereof in use;  
FIG. 10 is a top view thereof;  
FIG. 11 is a bottom view thereof with shading for illustrating adhesive;  
FIG. 12 is a right side view thereof with the left side view being a mirror image;  
FIG. 13 is a front view thereof;  
FIG. 14 is a back view thereof;  
FIG. 15 is a perspective view of another therapeutic elastic sports tape;  
FIG. 16 is another perspective view thereof in use;  
FIG. 17 is a top view thereof;  
FIG. 18 is a bottom view thereof with shading for illustrating adhesive;  
FIG. 19 is a right side view thereof with the left side view being a mirror image;  
FIG. 20 is a front view thereof;  
FIG. 21 is a back view thereof;  
FIG. 22 is another perspective view thereof in use;  
FIG. 23 is a top view thereof;  
FIG. 24 is a bottom view thereof with shading for illustrating adhesive;

(Continued)

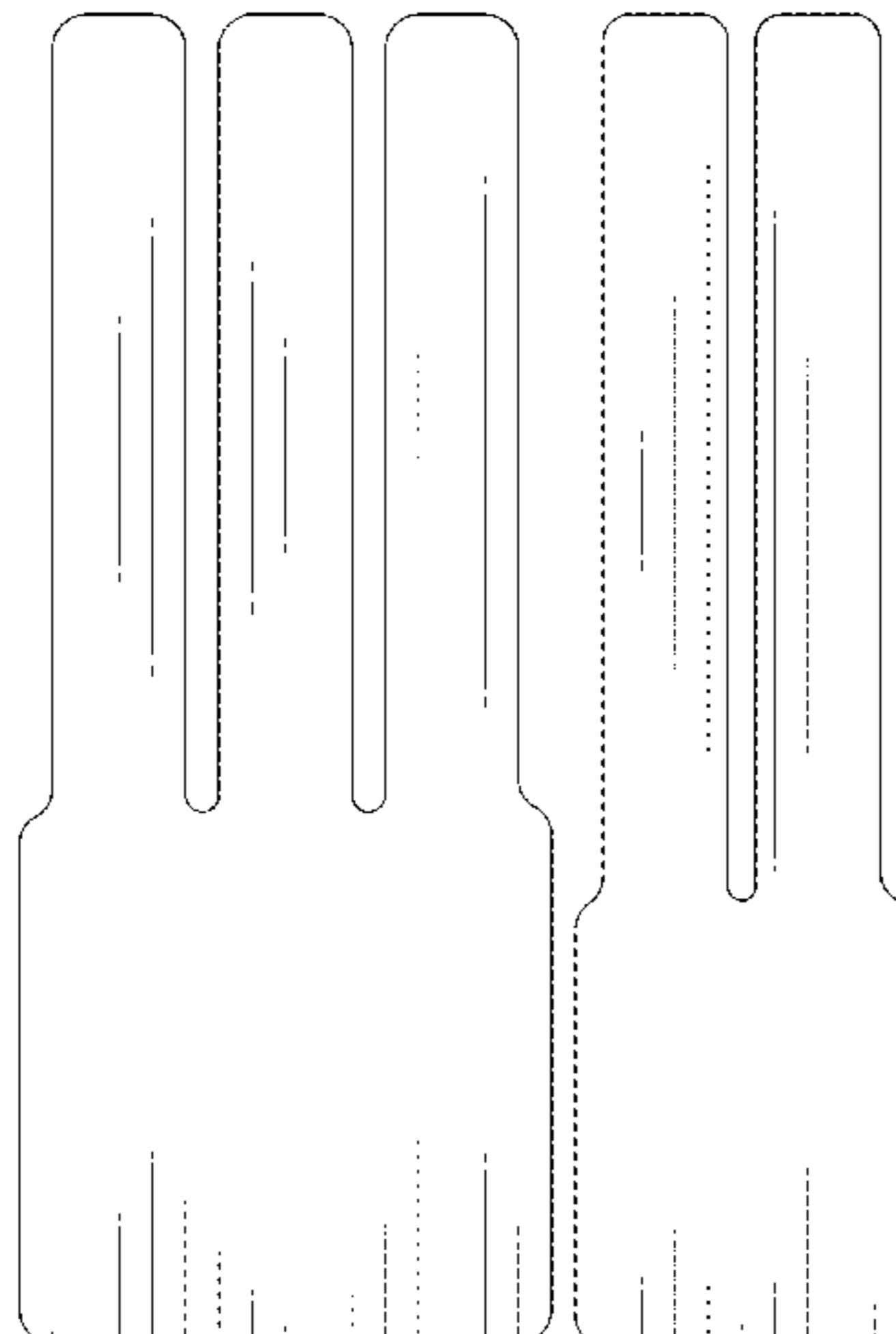

FIG. 25 is a right side view thereof with the left side view being a mirror image;  
 FIG. 26 is a front view thereof;  
 FIG. 27 is back view thereof;  
 FIG. 28 is a perspective view of a therapeutic elastic sports tape;  
 FIG. 29 is another perspective view thereof in use;  
 FIG. 30 is a top view thereof;  
 FIG. 31 is a bottom view thereof with shading for illustrating adhesive;  
 FIG. 32 is a right side view thereof with the left side view being a mirror image;  
 FIG. 33 is a front view thereof;  
 FIG. 34 is a back view thereof;  
 FIG. 35 is a perspective view of another therapeutic elastic sports tape;  
 FIG. 36 is a top view thereof;  
 FIG. 37 is a bottom view thereof with shading for illustrating adhesive;  
 FIG. 38 is a right side view thereof with the left side view being a mirror image;  
 FIG. 39 is a front view thereof;  
 FIG. 40 is a back view thereof;  
 FIG. 41 is a perspective view of another therapeutic elastic sports tape;  
 FIG. 42 is another perspective view thereof in use;  
 FIG. 43 is a top view thereof;  
 FIG. 44 is a bottom view thereof with shading for illustrating adhesive;  
 FIG. 45 is a right side view thereof with the left side view being a mirror image;  
 FIG. 46 is a front view thereof;  
 FIG. 47 is a back view thereof;  
 FIG. 48 is a perspective view of another therapeutic elastic sports tape; and,  
 FIG. 49 is another perspective view thereof in use.

1 Claim, 17 Drawing Sheets

(58) **Field of Classification Search**  
 USPC ..... D29/100, 108, 120.1, 121.1, 121.2;  
 D30/146

CPC . A61M 1/0088; A61F 13/00; A61F 13/00021;  
 A61F 13/066; A61F 13/0206; A61F  
 13/0203; A61F 13/00025; A61F  
 13/00038; A61F 13/023; A61F 13/0243;  
 A61F 13/0266

See application file for complete search history.

(56)

**References Cited**

U.S. PATENT DOCUMENTS

D239,981	S	*	5/1976	Arluck .....	D24/190
4,638,043	A		1/1987	Szycher et al.	
4,675,009	A		6/1987	Hymes et al.	
4,808,172	A		2/1989	Murata	
5,397,298	A		3/1995	Mazza et al.	
5,536,263	A		7/1996	Rolf et al.	
5,792,091	A	*	8/1998	Staudinger .....	A61F 13/10 602/20
5,861,348	A		1/1999	Kase	
6,447,470	B2		9/2002	Bodenschatz et al.	
D612,505	S	*	3/2010	Arbesman .....	D24/190
D612,506	S	*	3/2010	Arbesman .....	D24/190
D612,944	S	*	3/2010	Arbesman .....	D24/190
D616,553	S	*	5/2010	Arbesman .....	D24/190
D625,422	S	*	10/2010	Arbesman .....	D24/189
D625,825	S	*	10/2010	Arbesman .....	D24/189
D625,826	S	*	10/2010	Arbesman .....	D24/190
D625,827	S	*	10/2010	Arbesman .....	D24/190
D625,828	S	*	10/2010	Arbesman .....	D24/190
D625,829	S	*	10/2010	Arbesman .....	D24/190
D639,964	S	*	6/2011	Kase .....	D24/189
D649,255	S	*	11/2011	Kase .....	D24/189
D691,276	S	*	10/2013	Bushby .....	D24/189
D737,986	S	*	9/2015	Arbesman .....	D24/189
D743,566	S	*	11/2015	Arbesman .....	D24/189
D804,679	S	*	12/2017	Kase .....	D24/189
D832,428	S	*	10/2018	Kyvik .....	D24/128
D842,986	S	*	3/2019	Parkhurst .....	D24/128
2006/0034904	A1		2/2006	Weimann	
2007/0148214	A1		6/2007	Cullen et al.	
2008/0076722	A1		3/2008	Roberts et al.	
2008/0131488	A1		6/2008	Kawamura et al.	
2008/0167535	A1		7/2008	Stivoric et al.	
2009/0297590	A1		12/2009	Yamaji et al.	
2011/0275969	A1		11/2011	Quinn	
2013/0060209	A1		3/2013	Tyler et al.	
2015/0217098	A1		8/2015	Hicken et al.	

\* cited by examiner

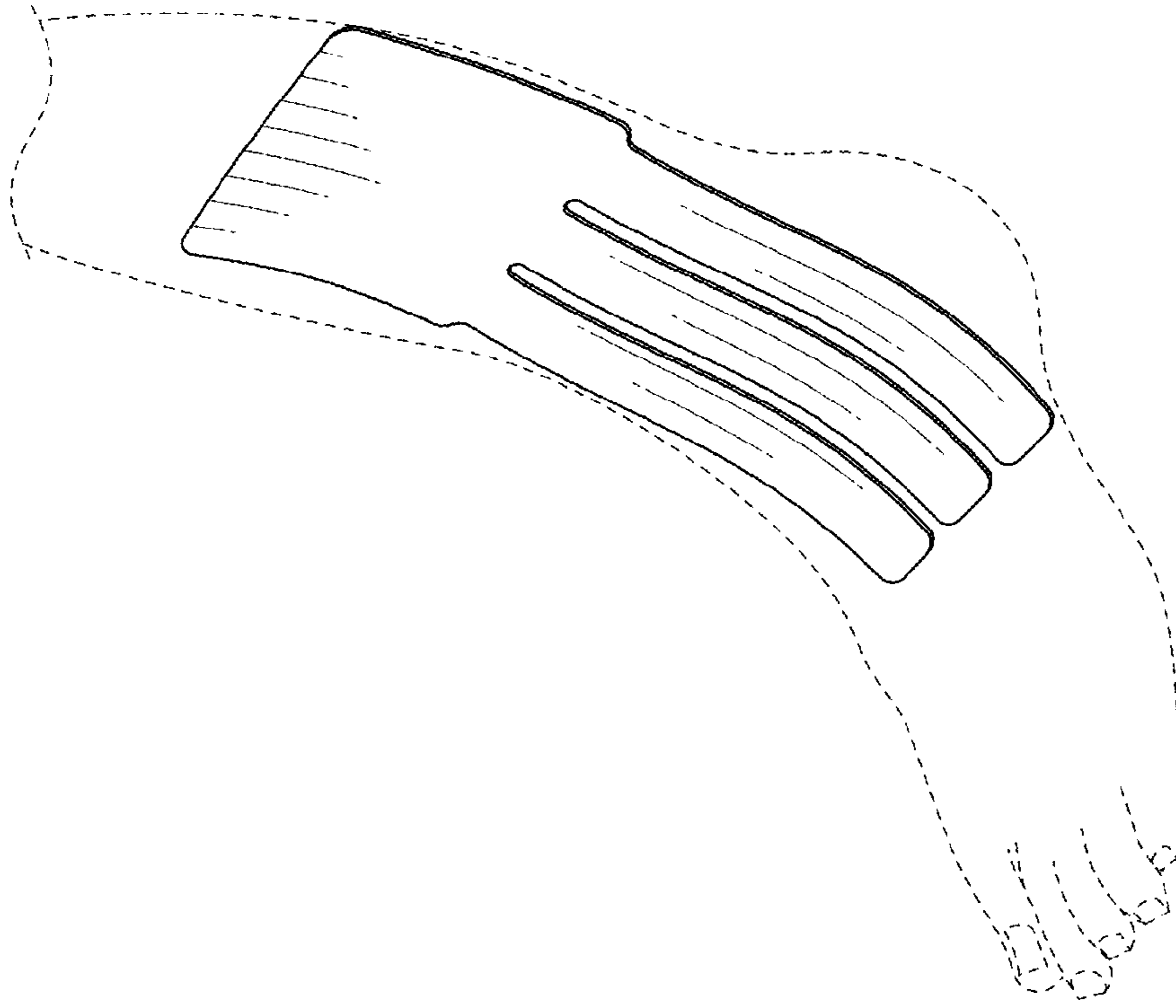

FIG. 2

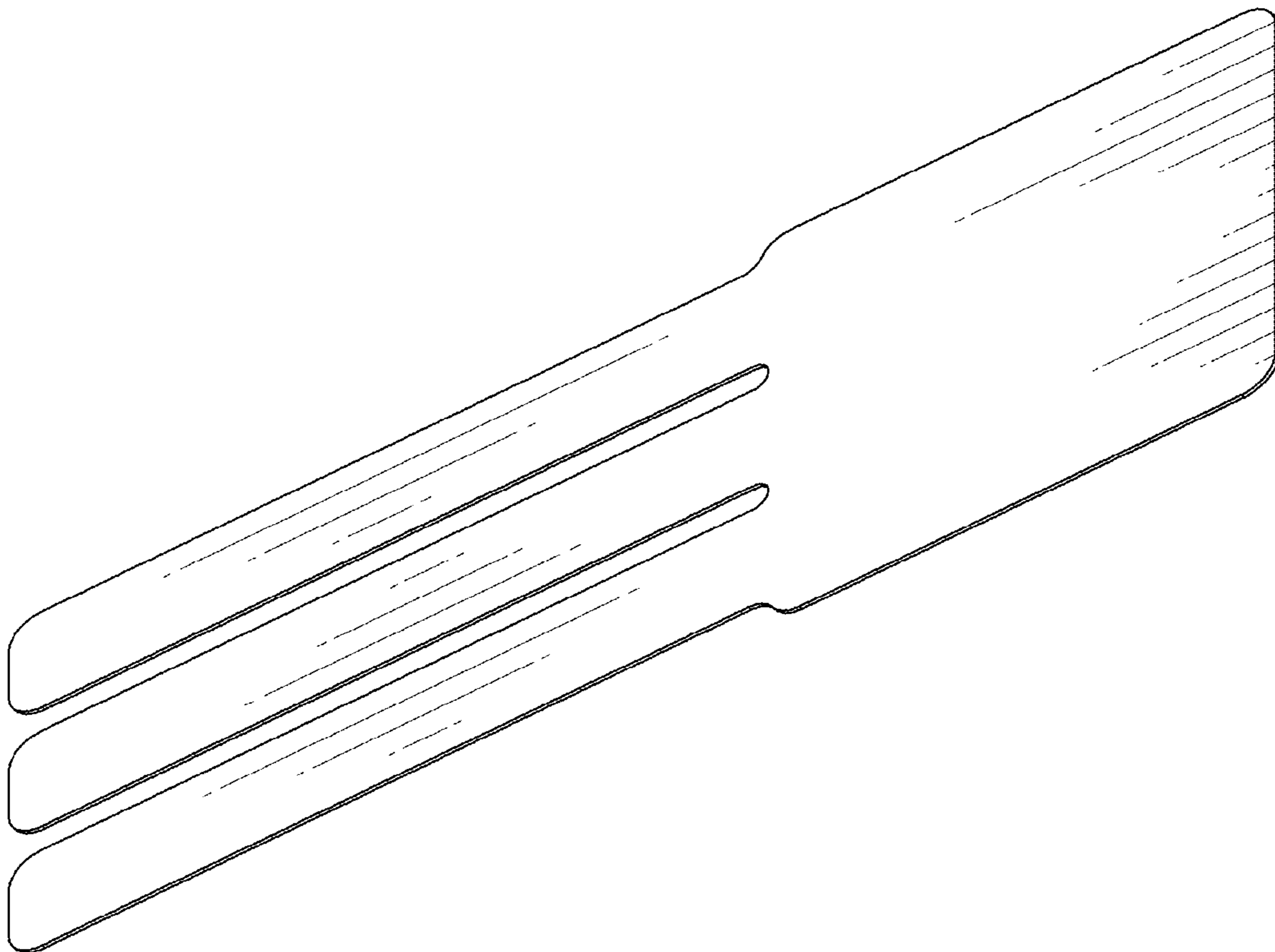
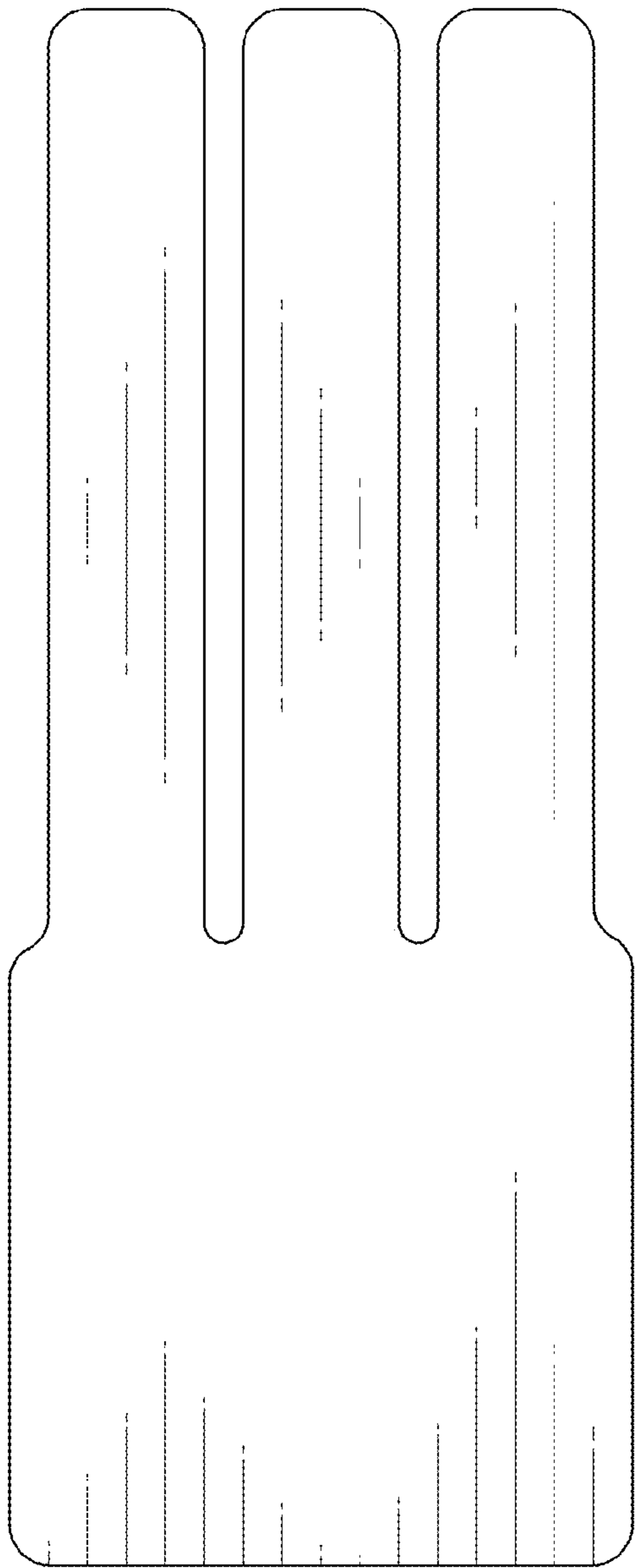
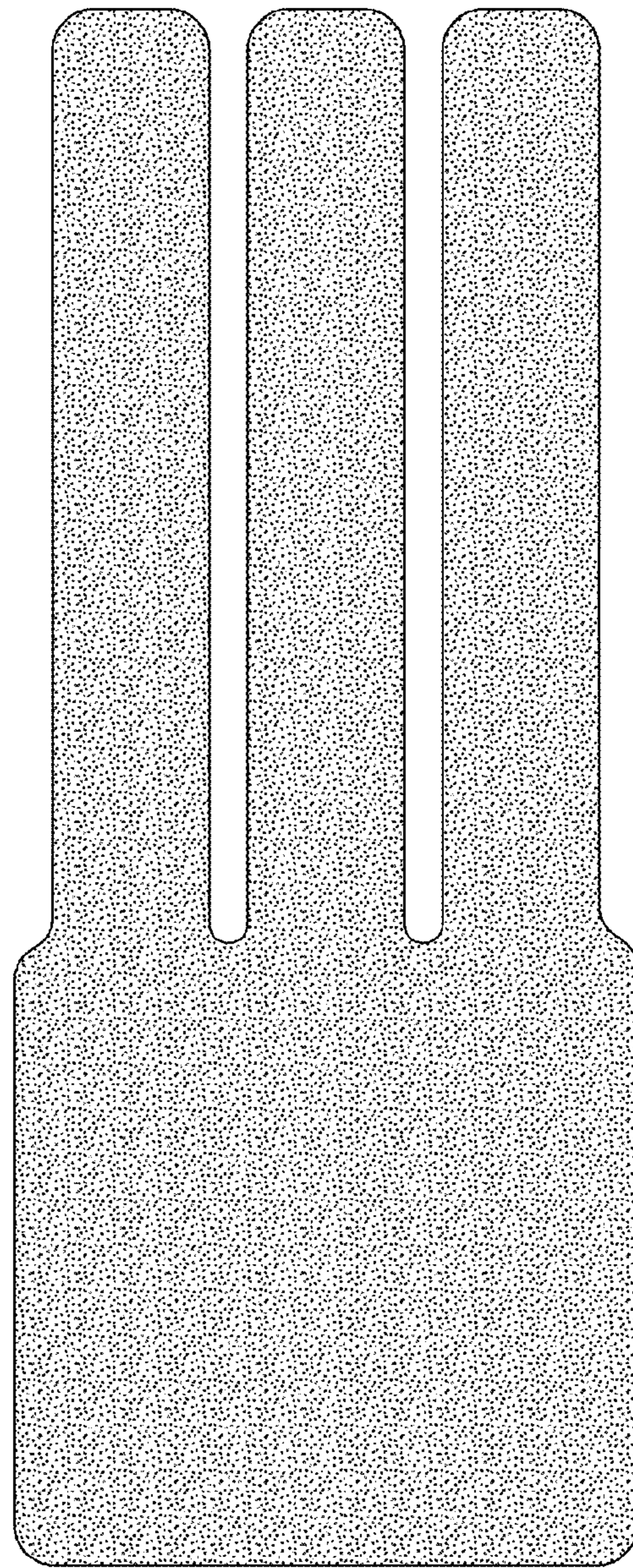

FIG. 1



**FIG. 3**



**FIG. 4**



**FIG. 5**

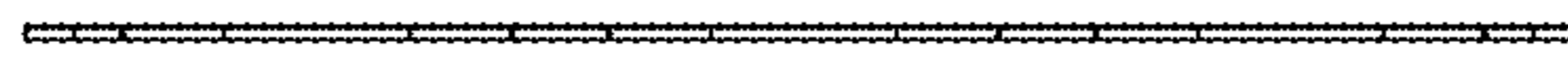

**FIG. 6**

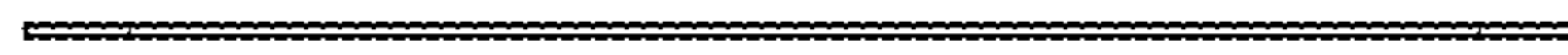

**FIG. 7**

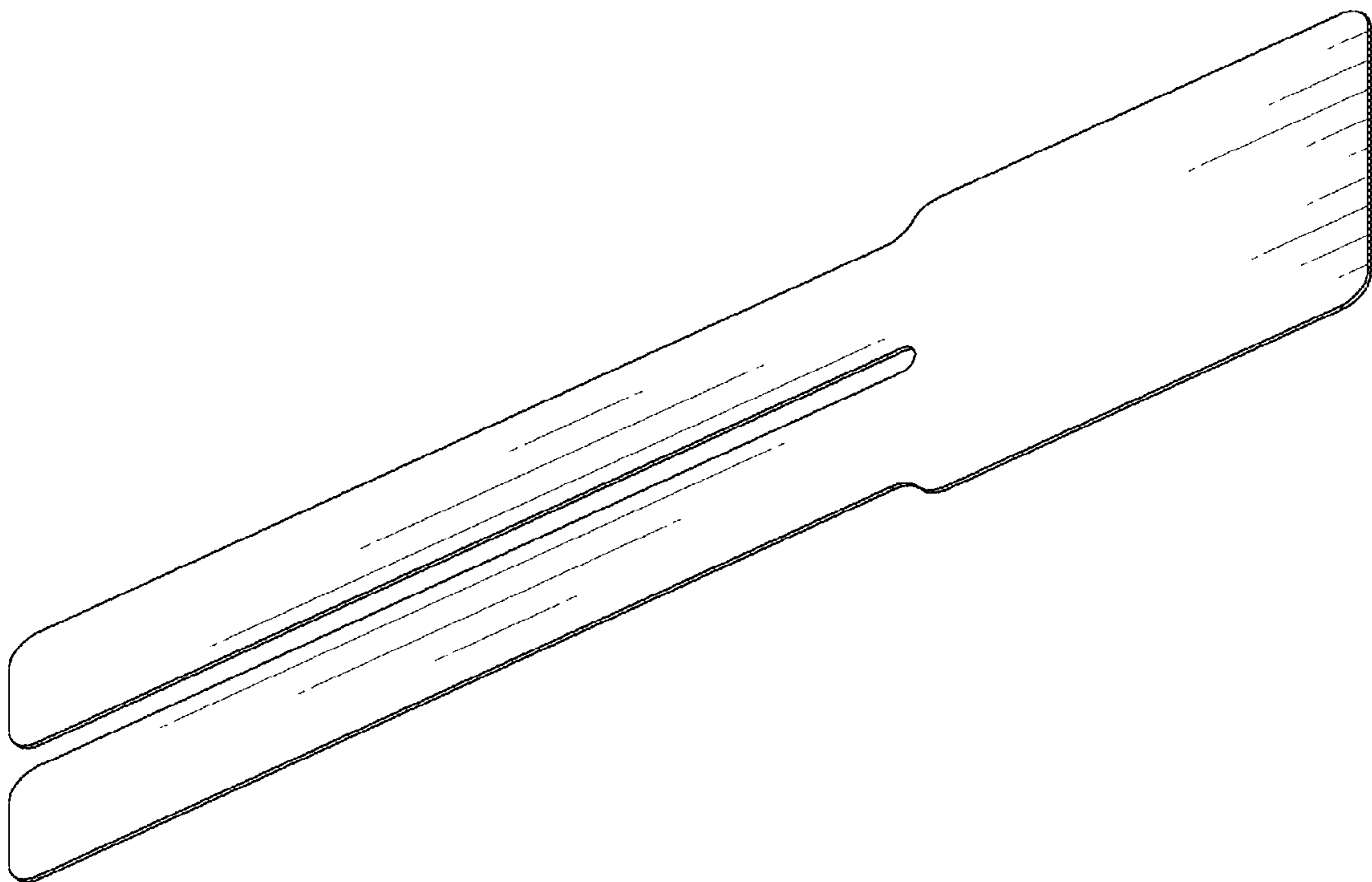

FIG. 8

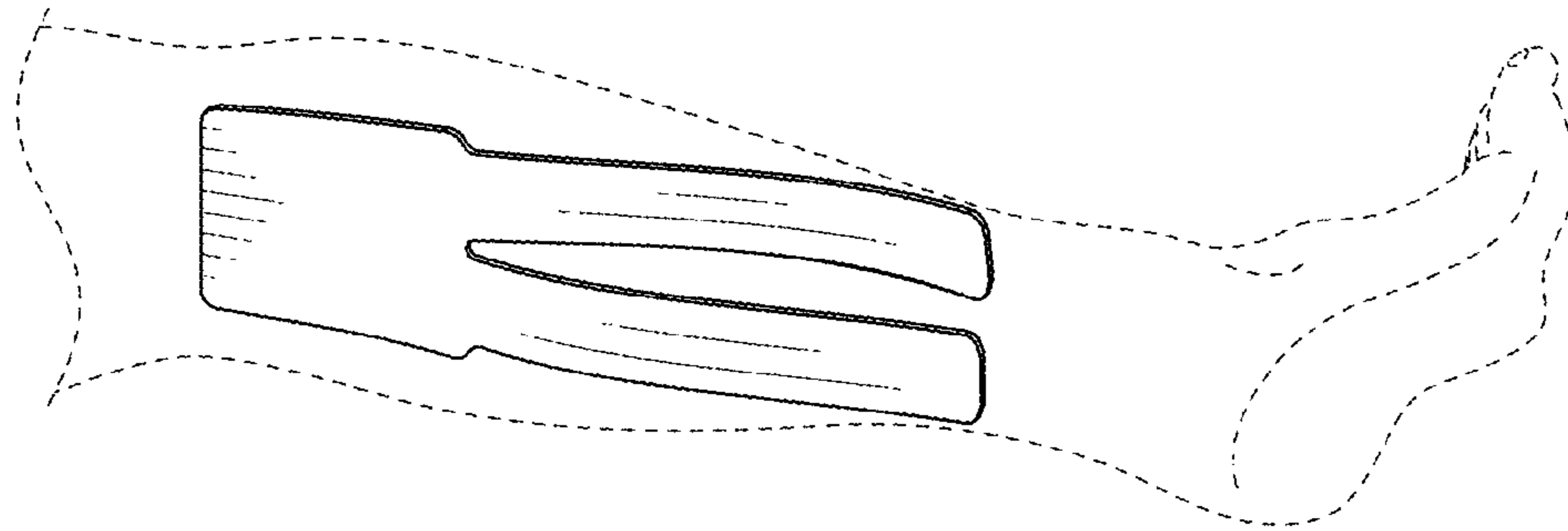
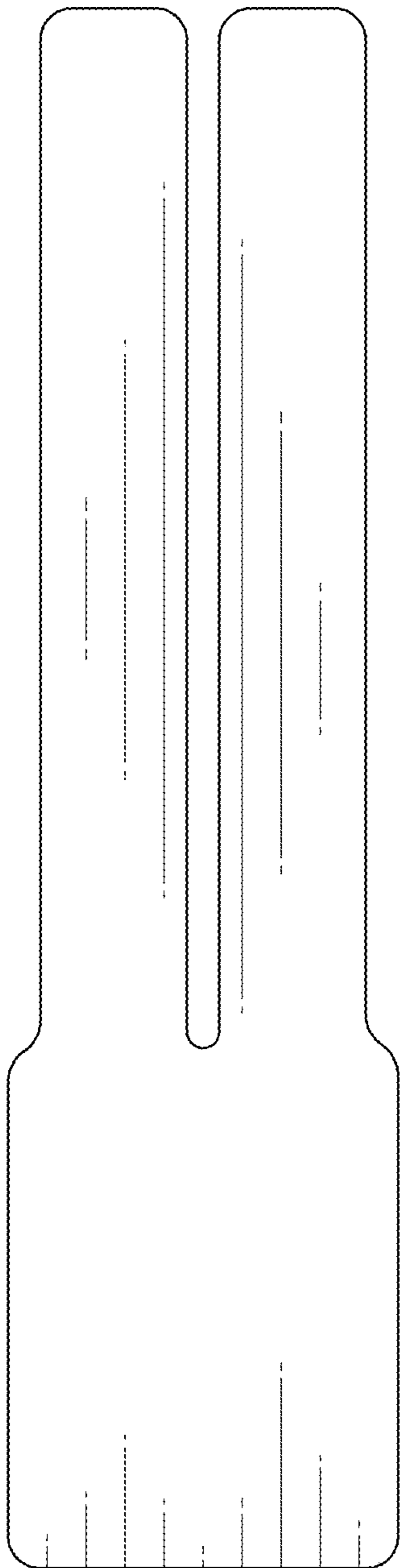
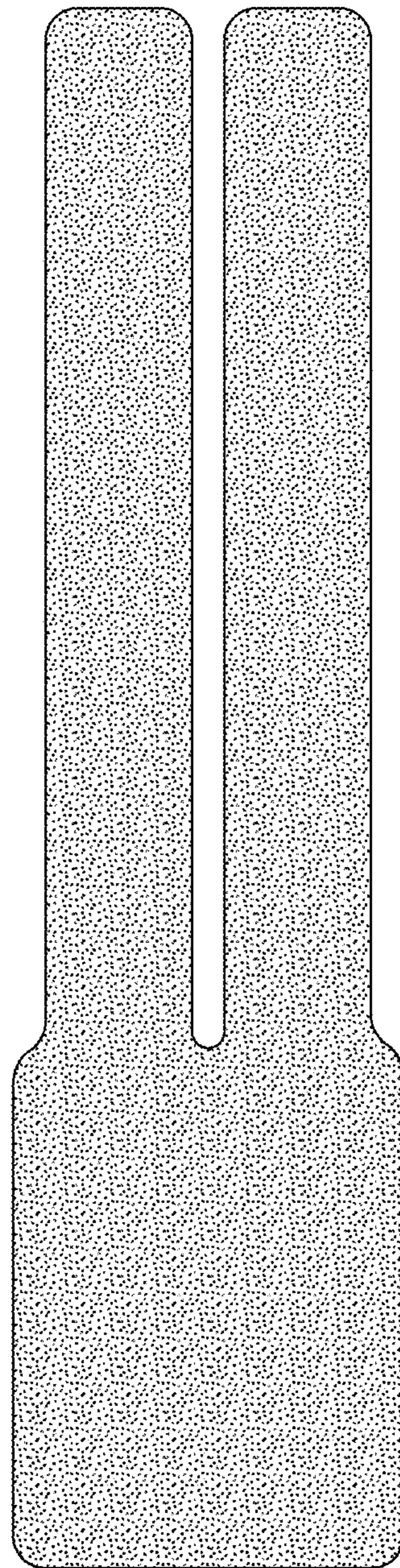

FIG. 9



**FIG. 10**



**FIG. 11**



**FIG. 12**



**FIG. 13**



**FIG. 14**

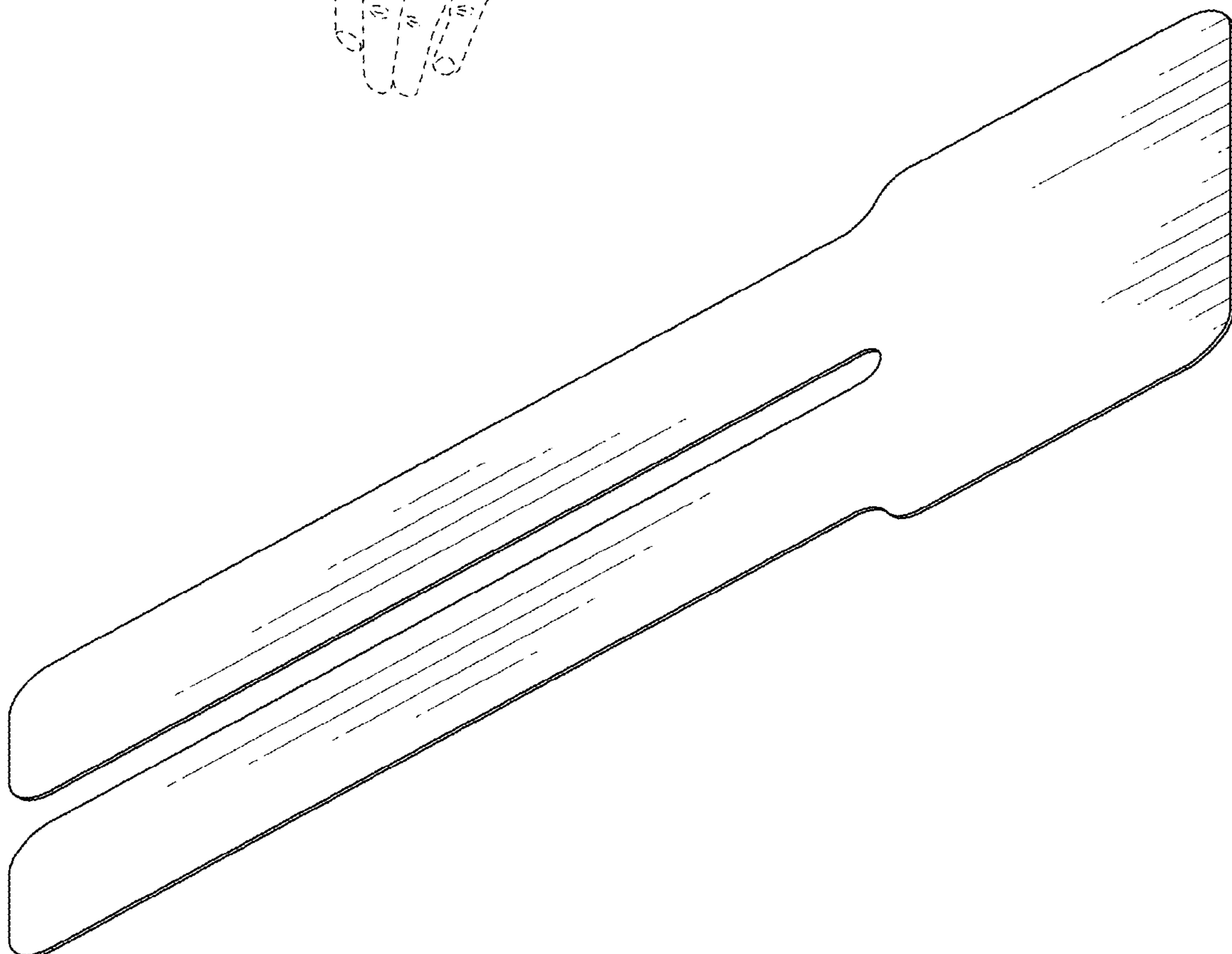

FIG. 15

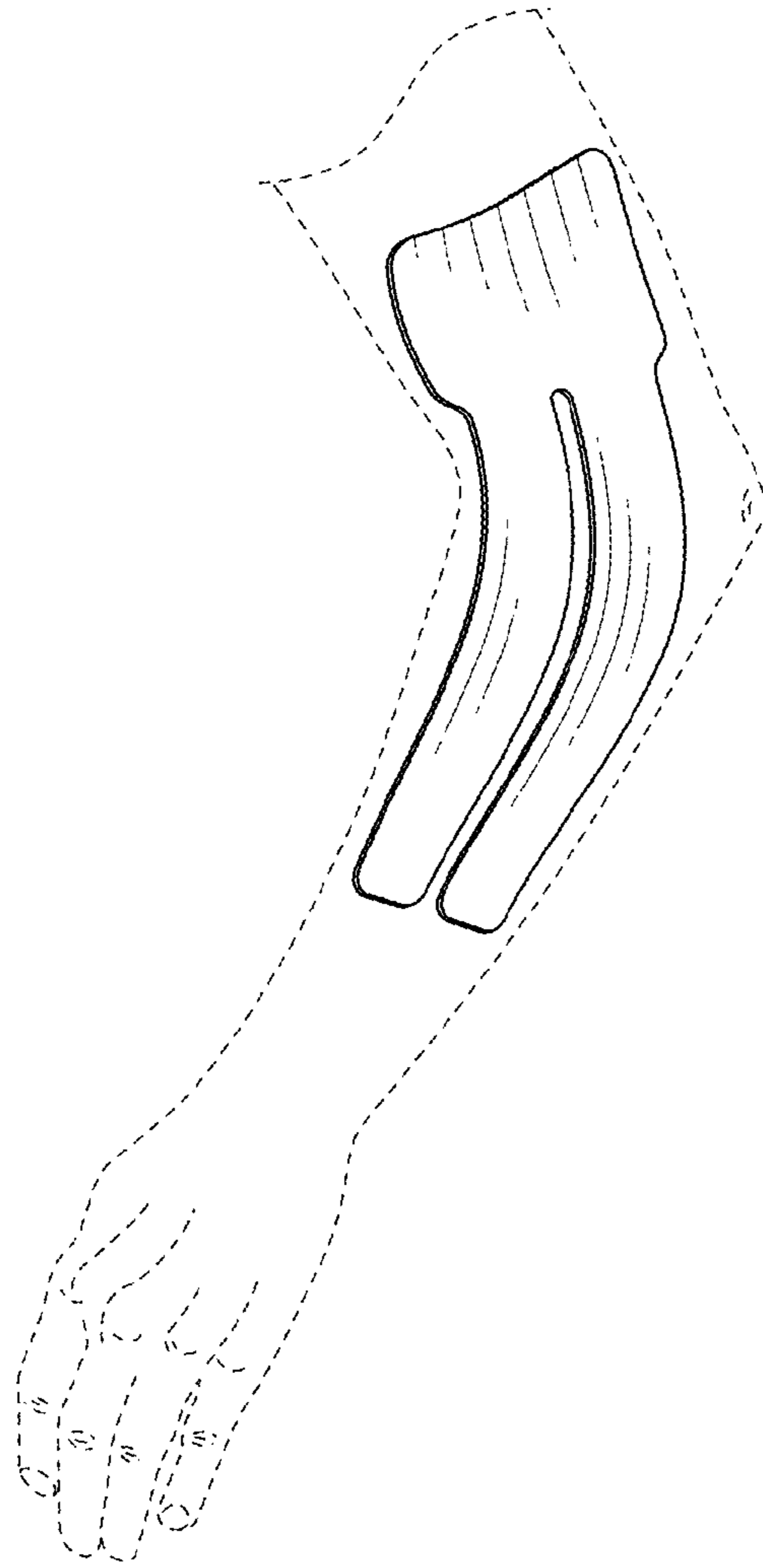

FIG. 16

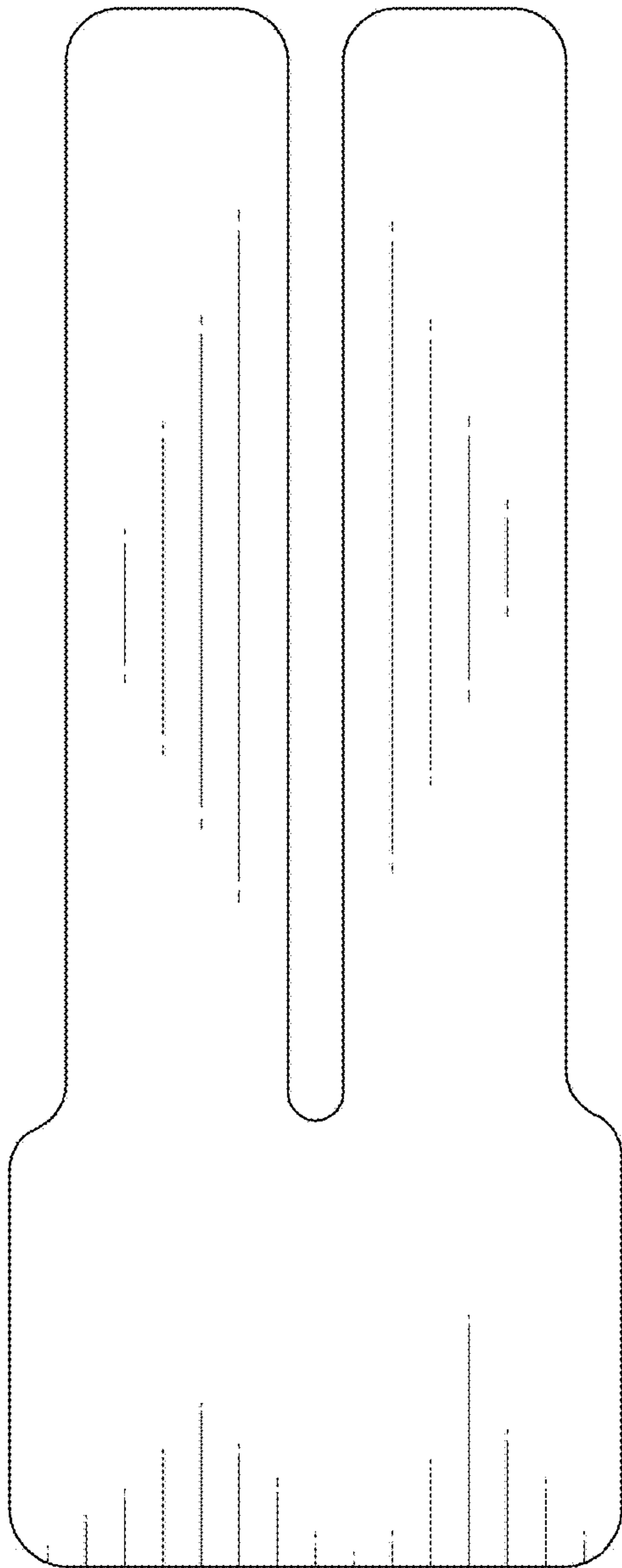

FIG. 17

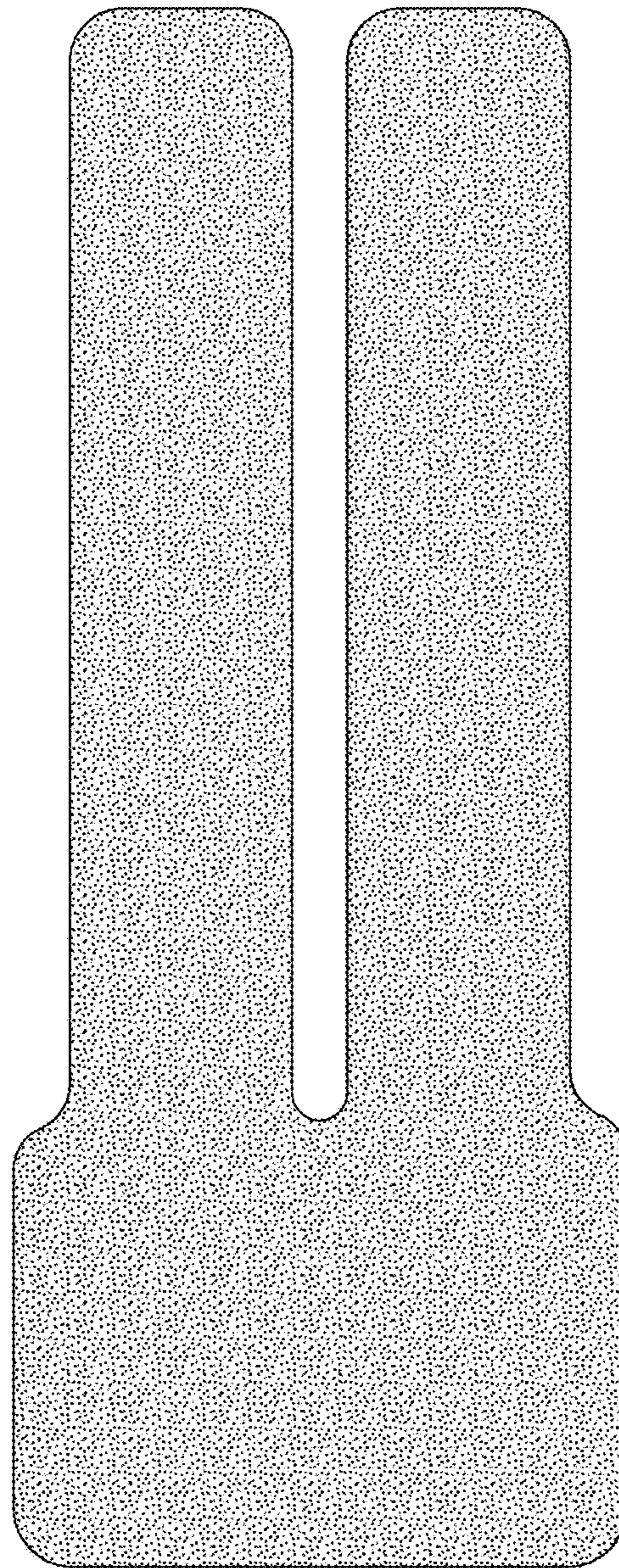

FIG. 18



FIG. 19

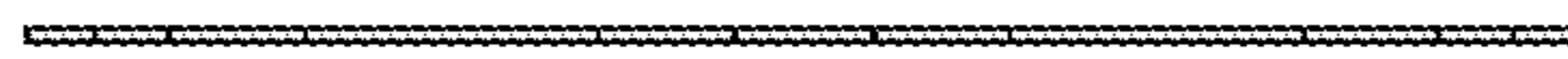

FIG. 20



FIG. 21



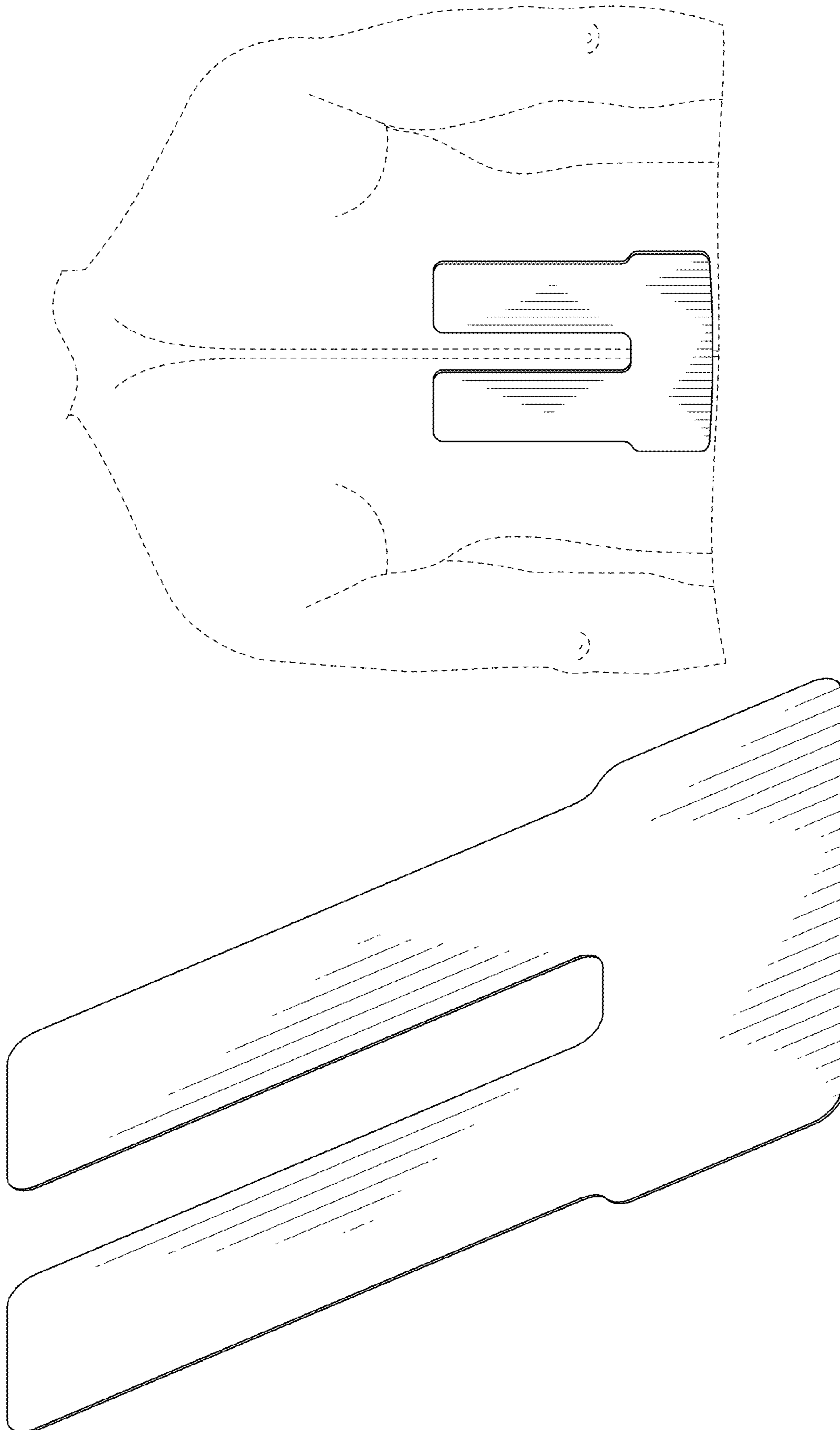

FIG. 23

FIG. 22

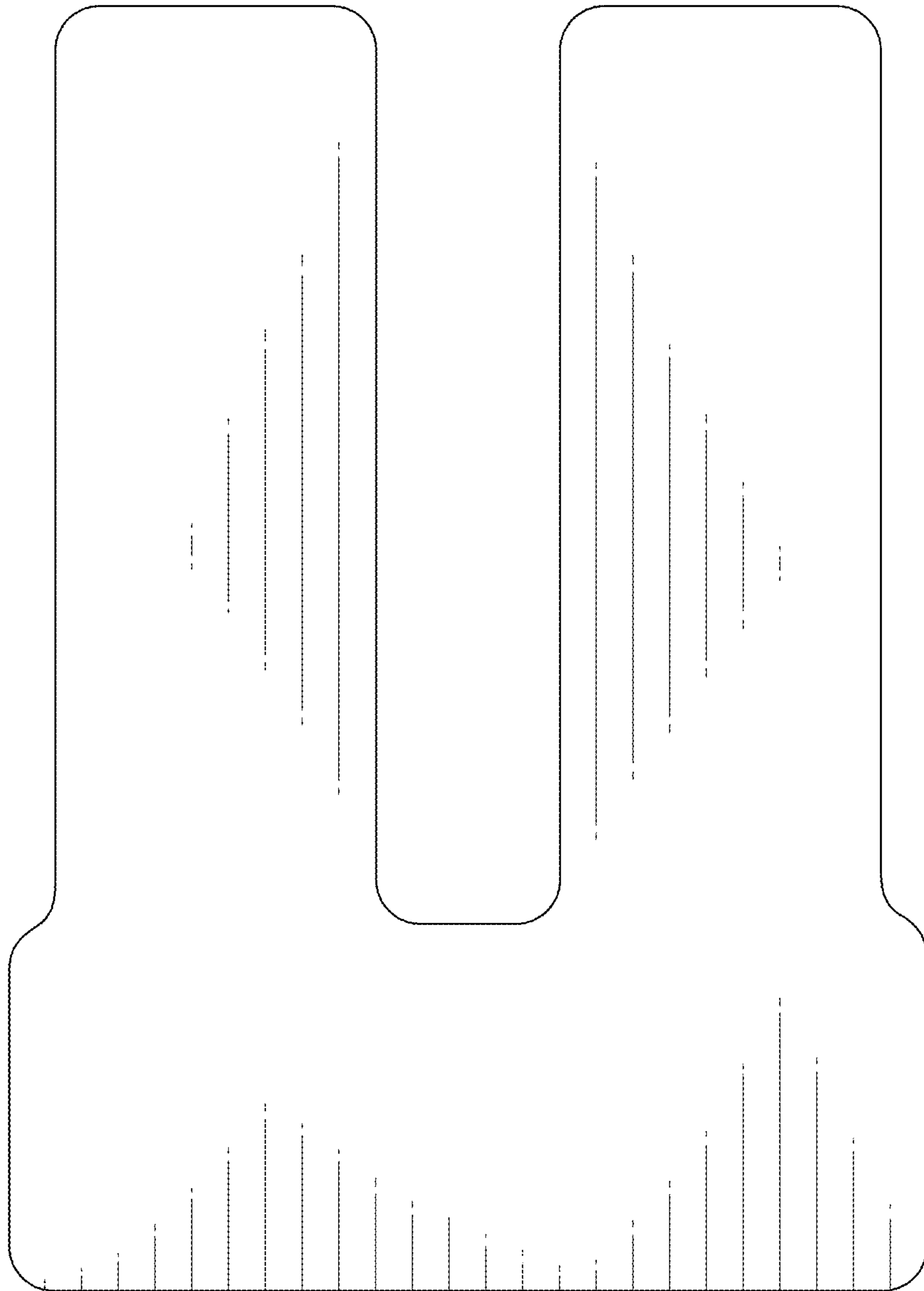

FIG. 24

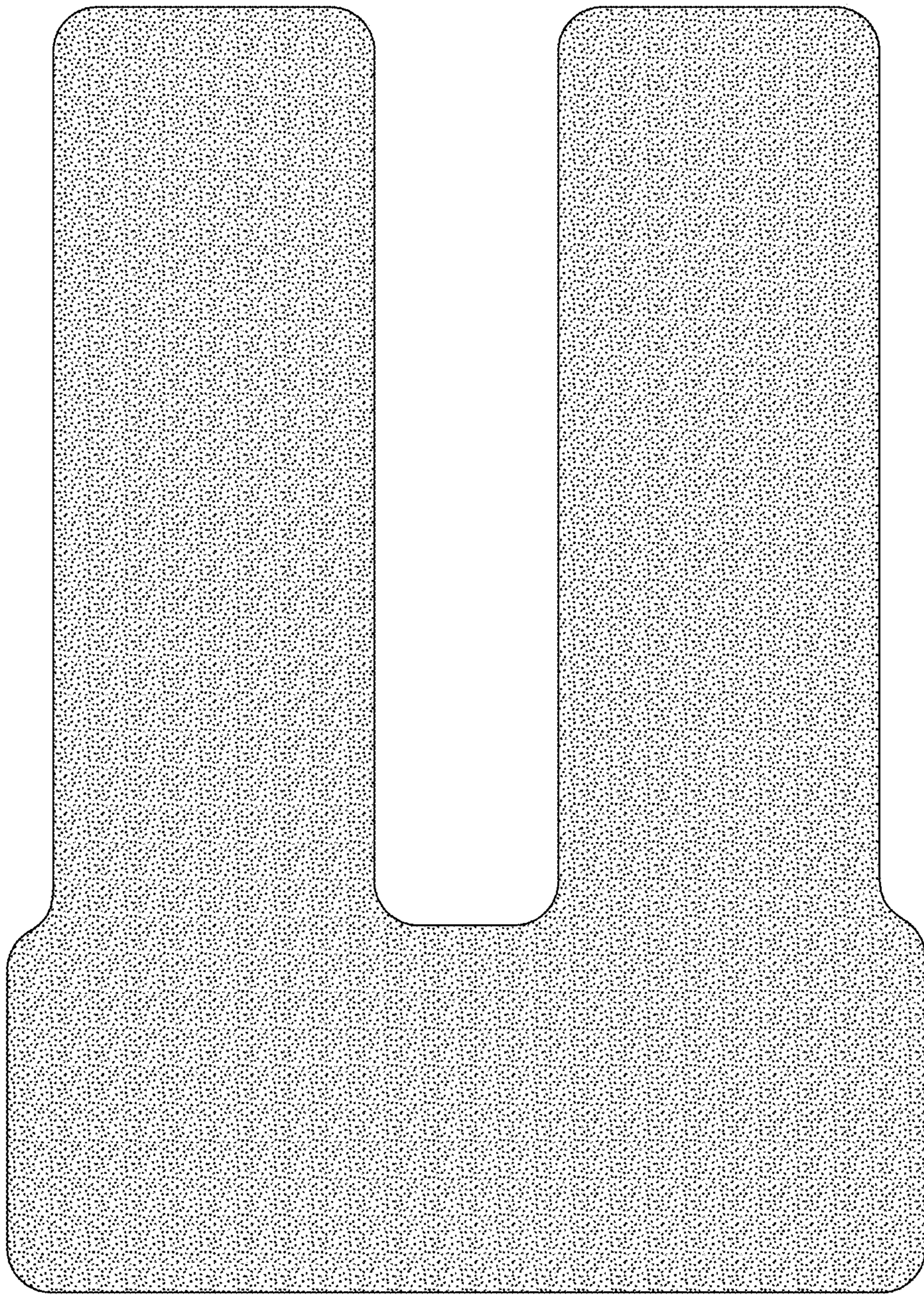

FIG. 25



FIG. 26

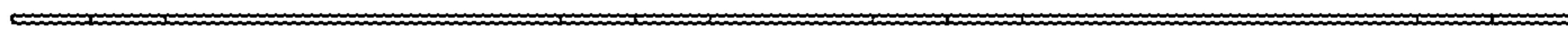

FIG. 27

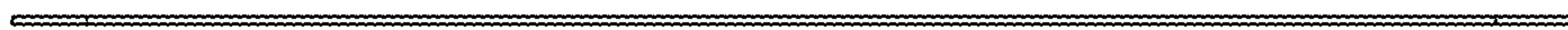

FIG. 28

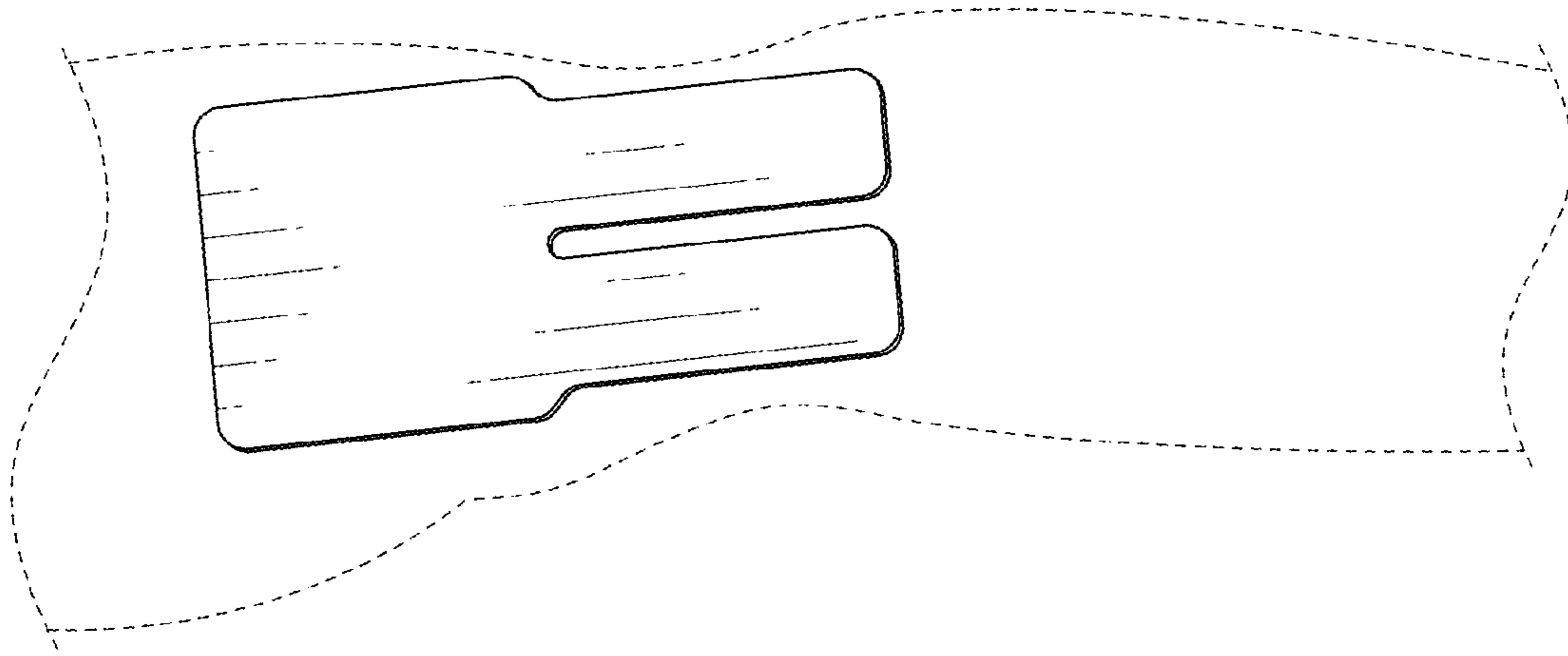

FIG. 30

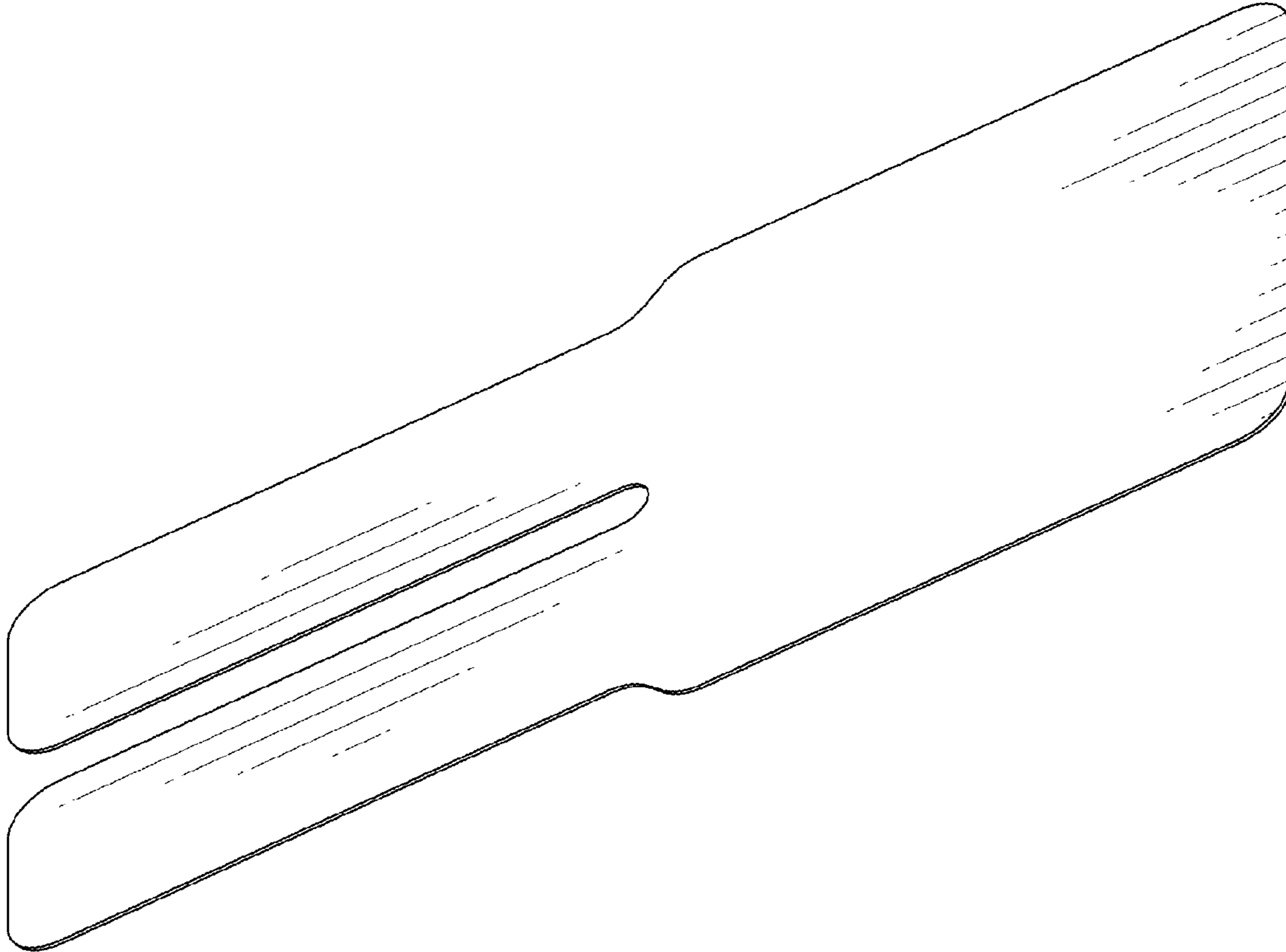
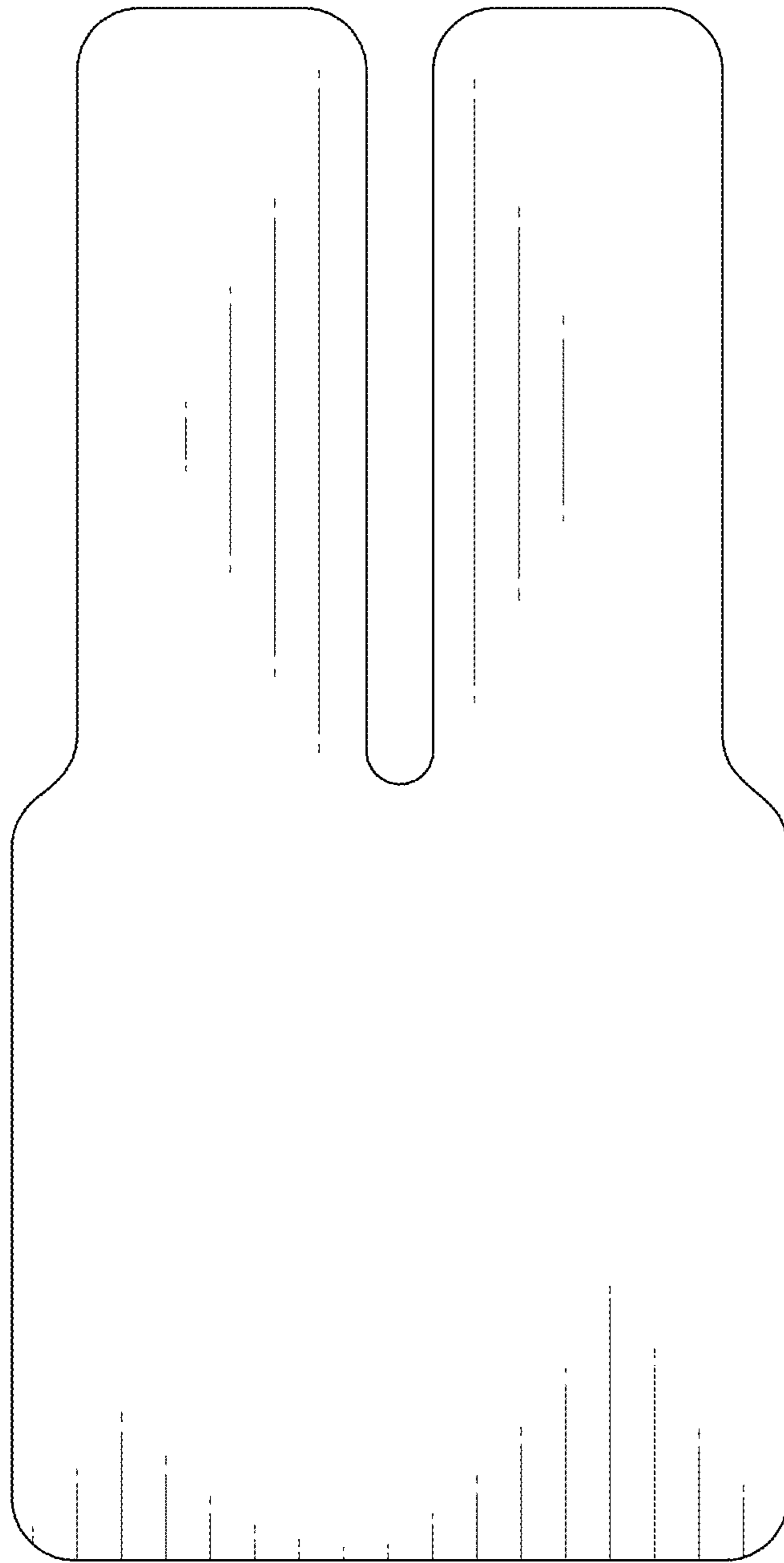
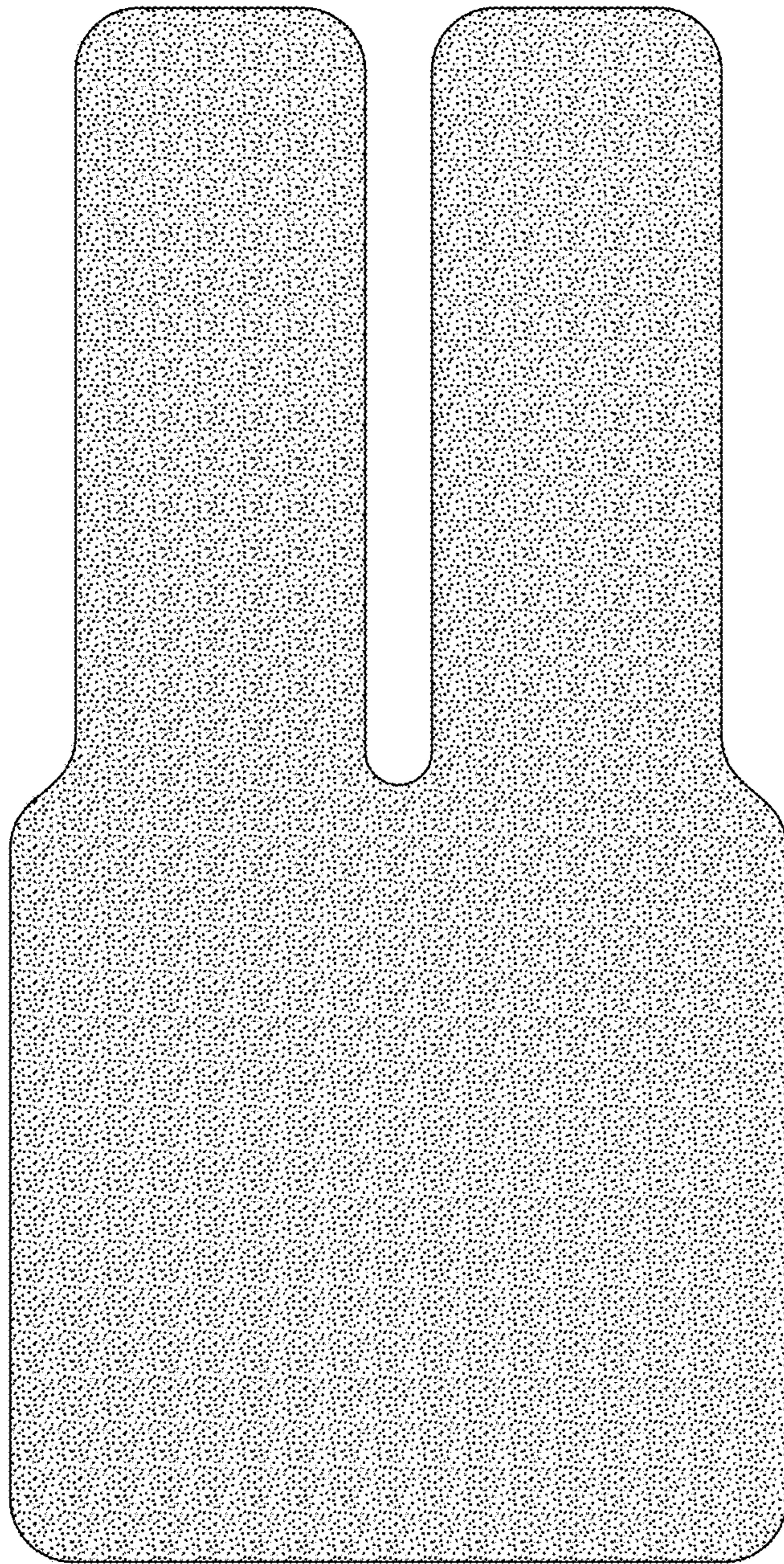

FIG. 29



**FIG. 31**



**FIG. 32**

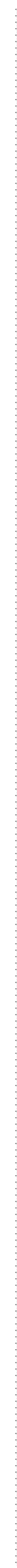

**FIG. 33**

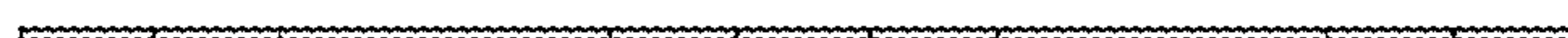

**FIG. 34**



**FIG. 35**

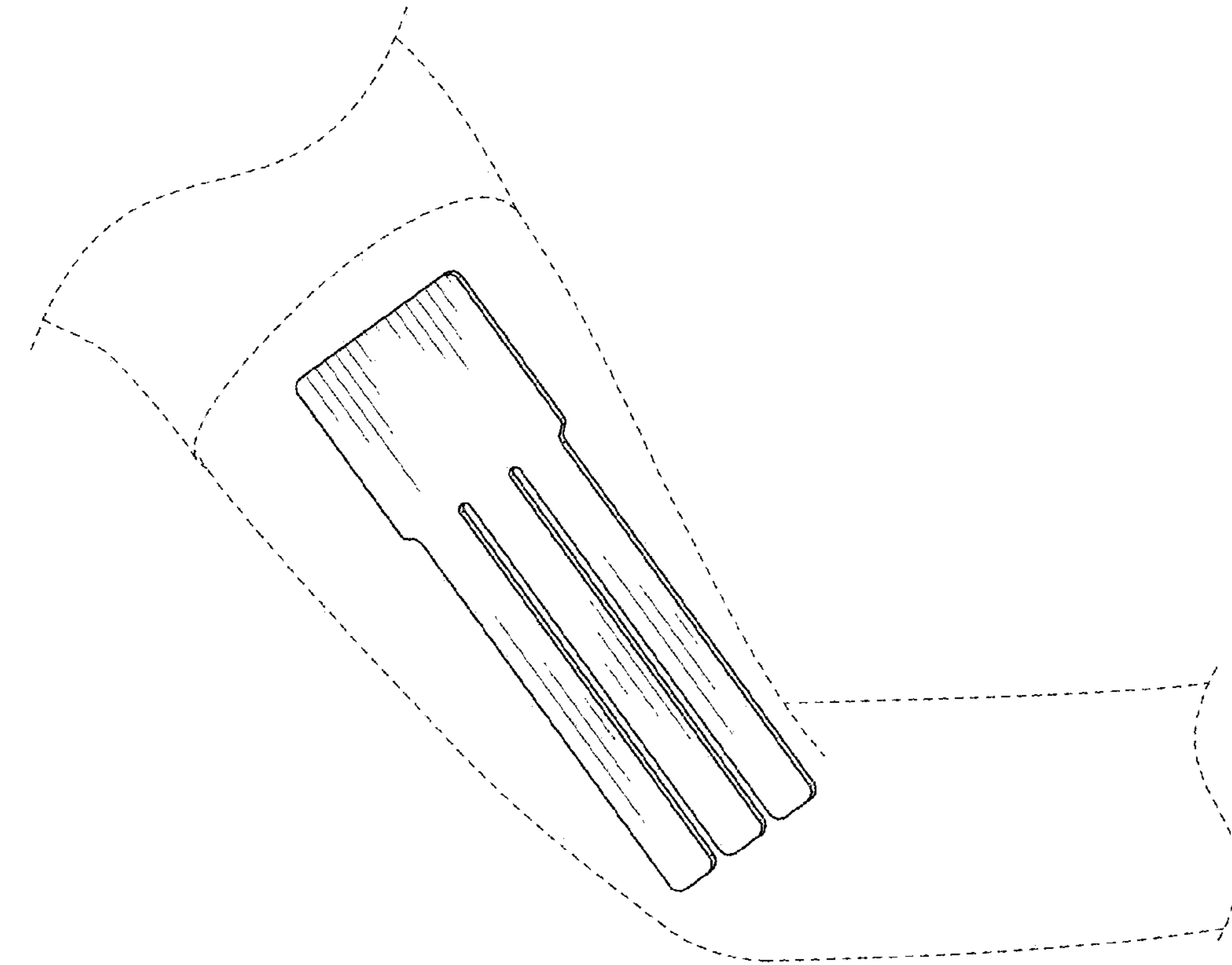

FIG. 37

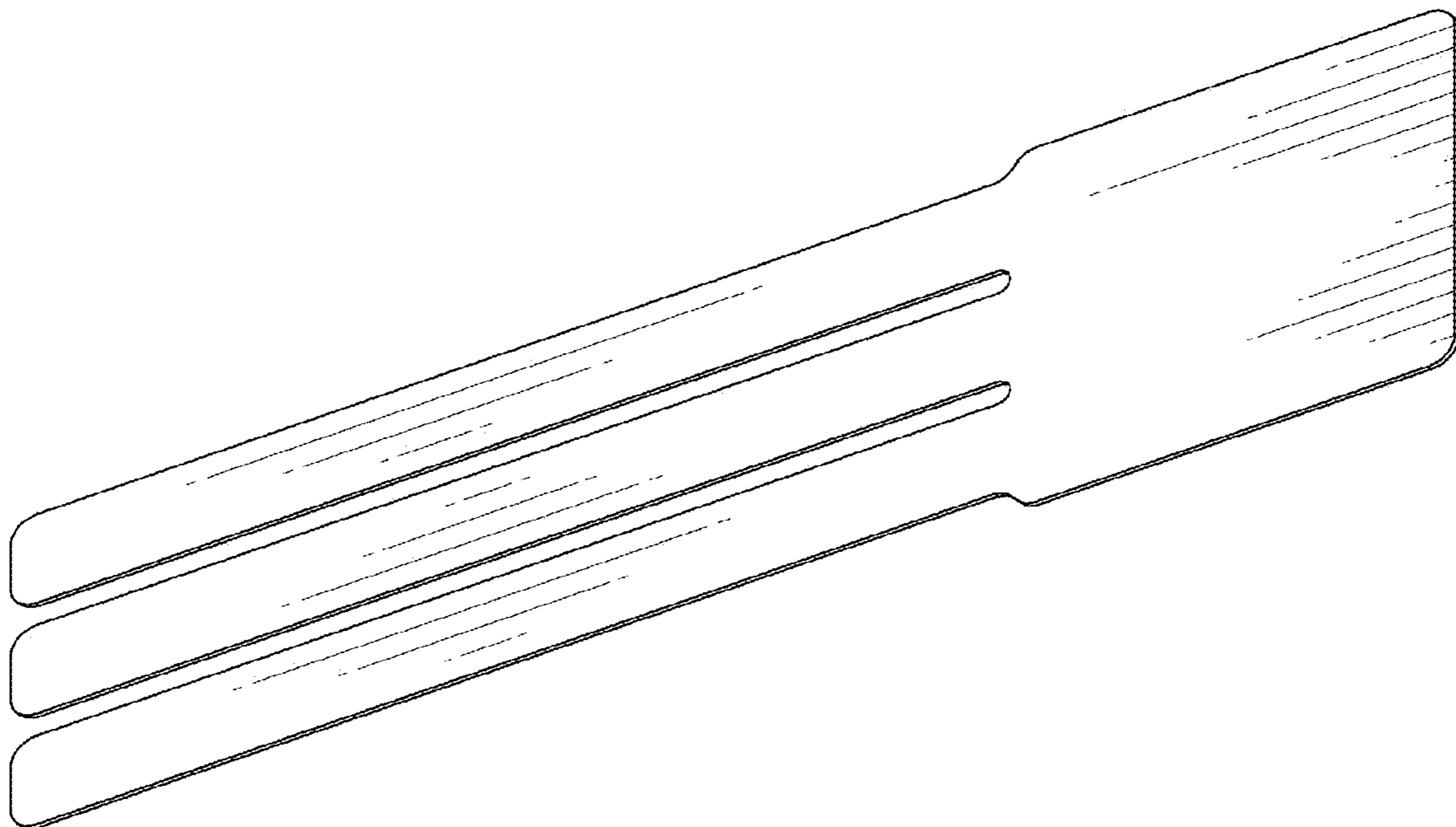

FIG. 36

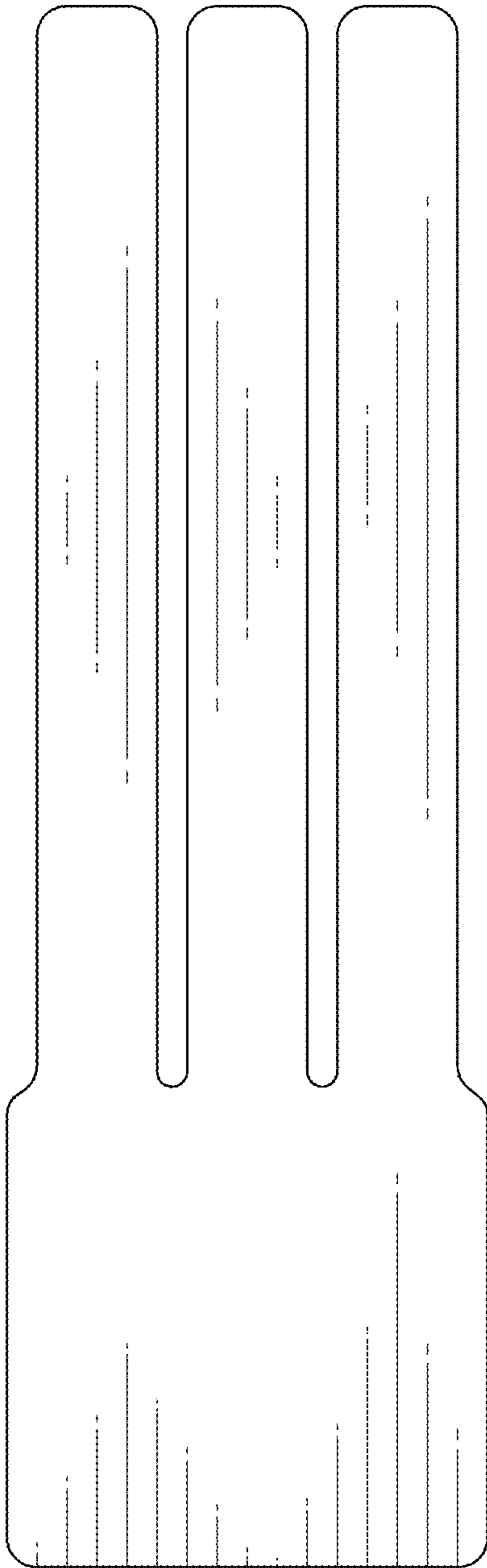

FIG. 38

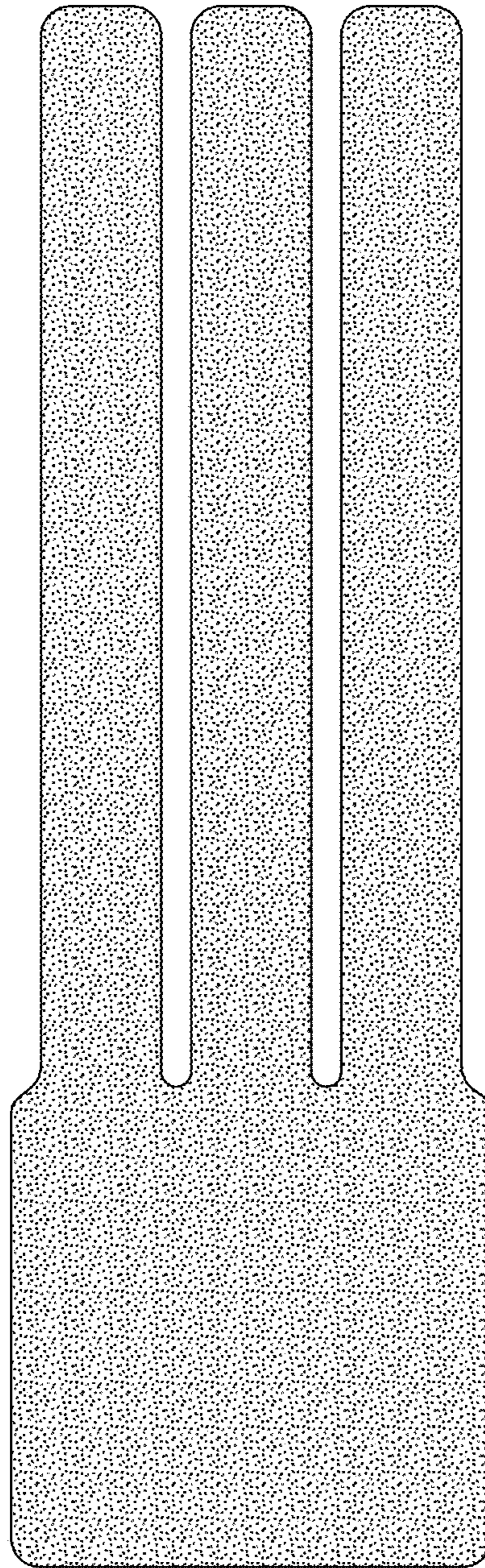

FIG. 39



FIG. 40

---

FIG. 41

---

FIG. 42



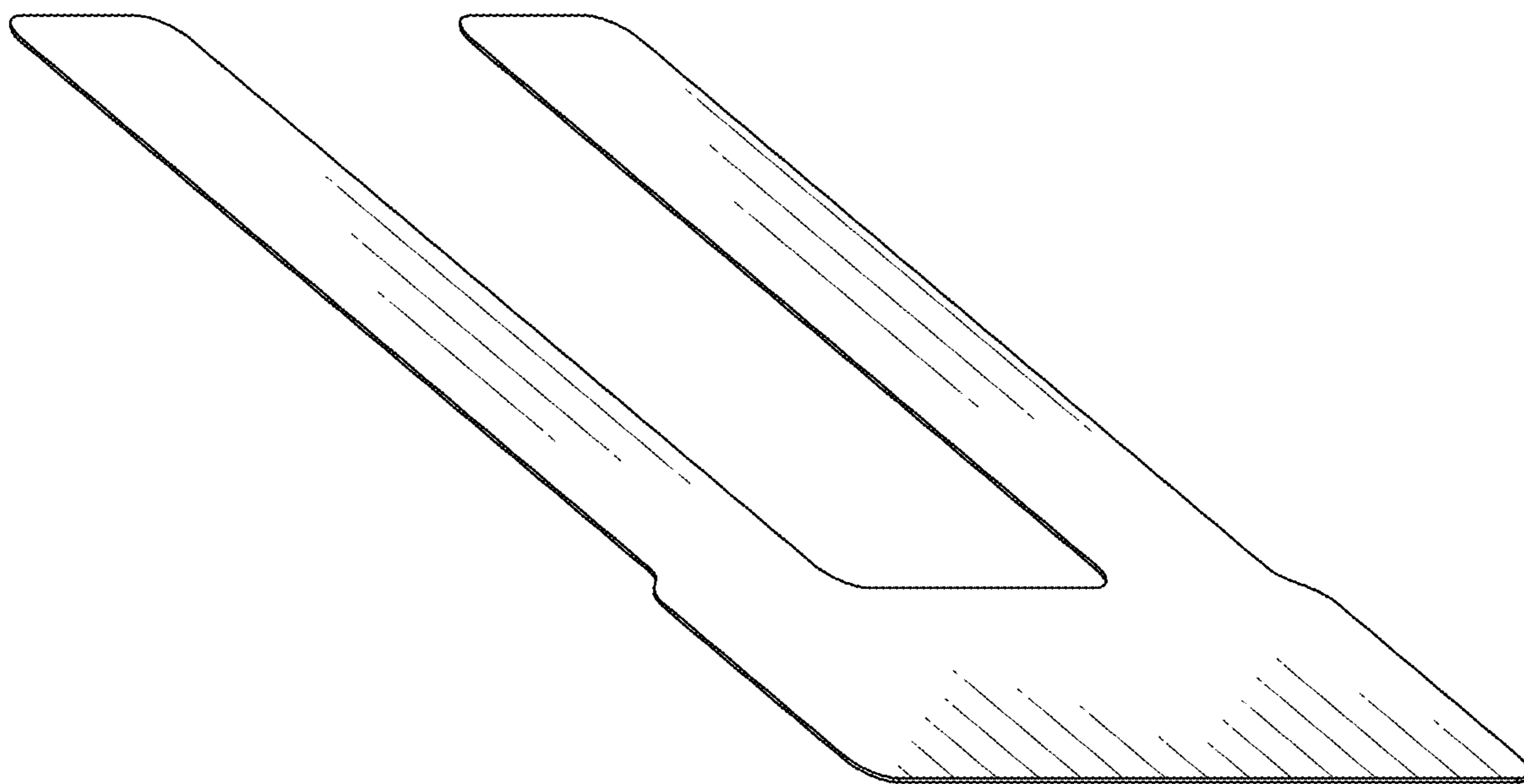

FIG. 43

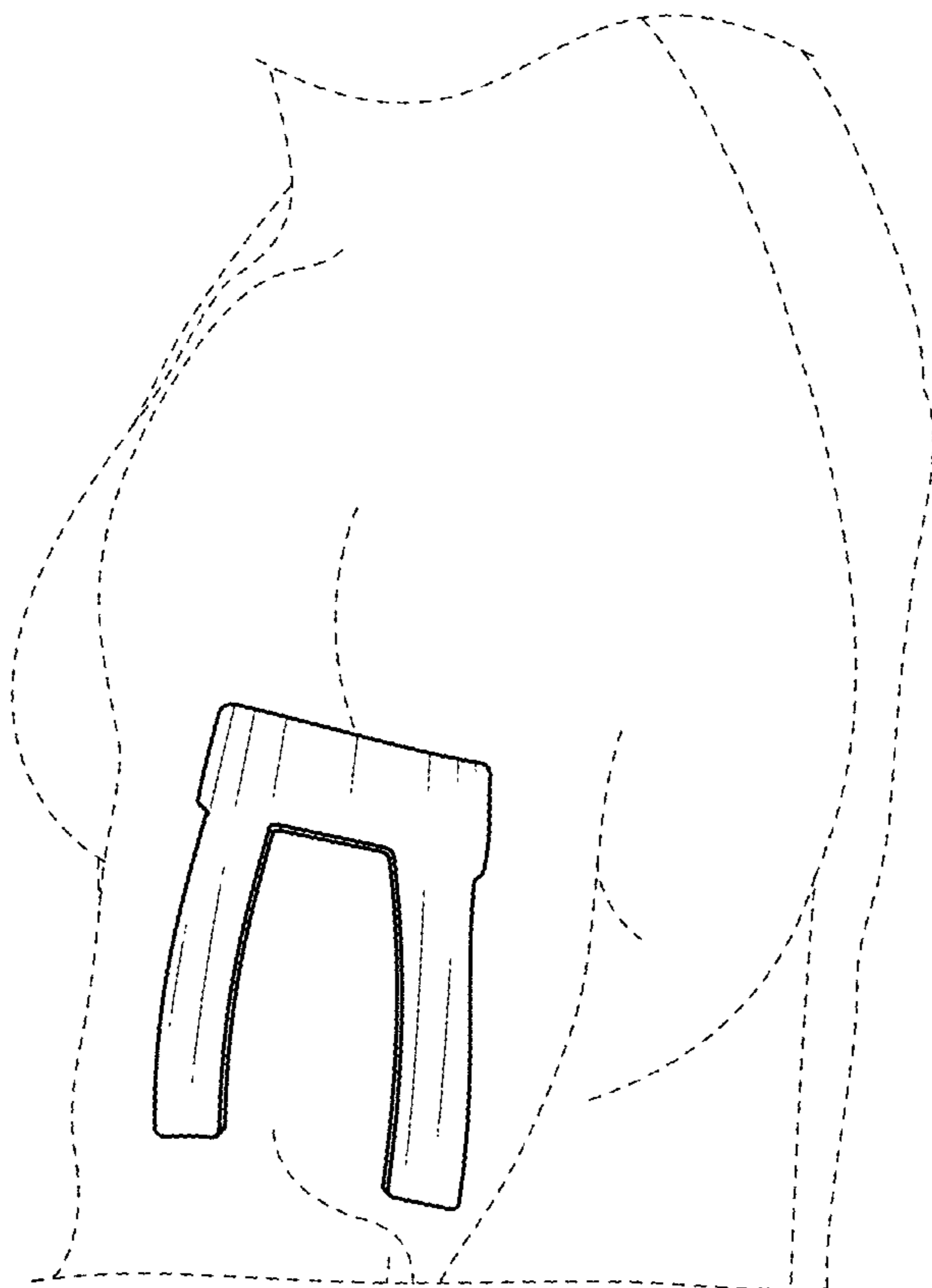

FIG. 44

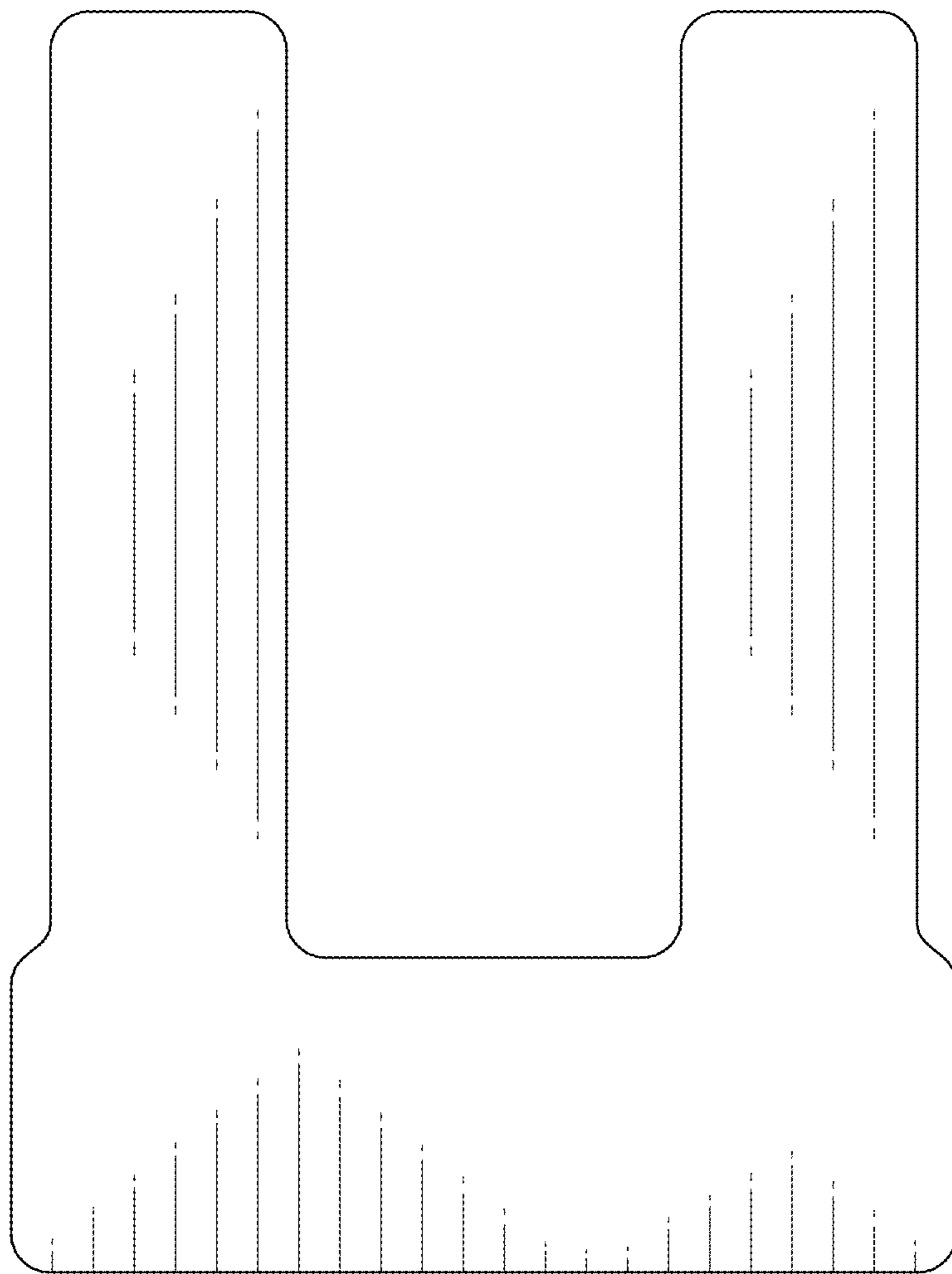
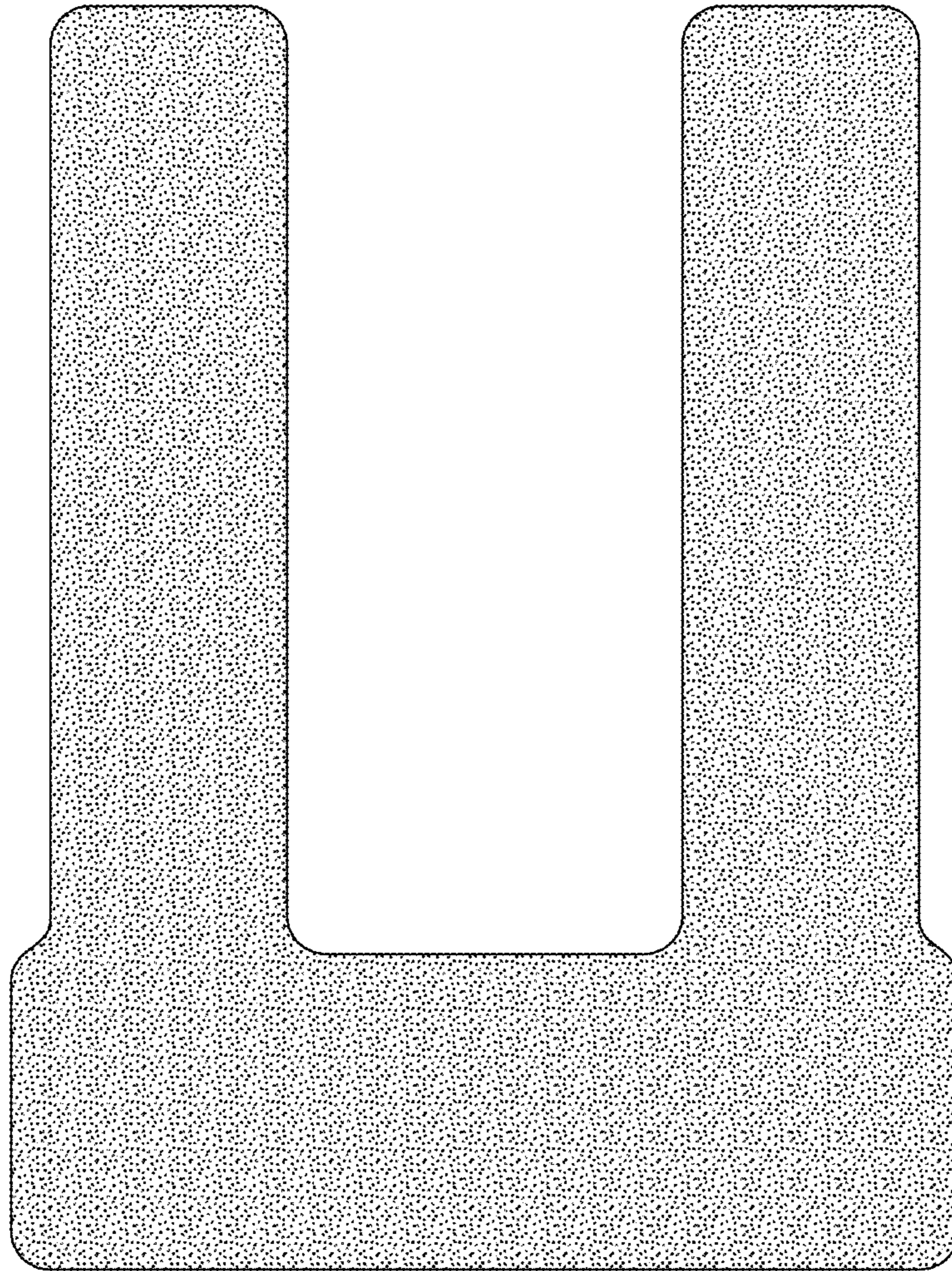
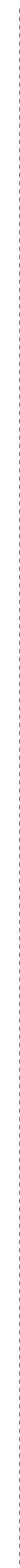

FIG. 45



**FIG. 46**



**FIG. 47**

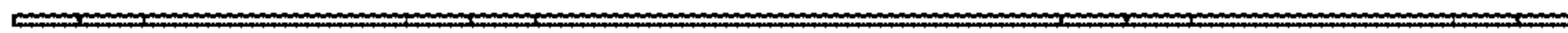

**FIG. 48**



**FIG. 49**