



US00D890835S

(12) **United States Design Patent**  
**Nguyen et al.**

(10) **Patent No.:** **US D890,835 S**

(45) **Date of Patent:** **\*\* Jul. 21, 2020**

(54) **CAMERA**

(71) Applicant: **GoPro, Inc.**, San Mateo, CA (US)

(72) Inventors: **Huy Phuong Nguyen**, San Mateo, CA (US); **Senka Agic Bergman**, Montara, CA (US); **Daniel J. Coster**, San Francisco, CA (US)

(73) Assignee: **GoPro, Inc.**, San Mateo, CA (US)

(\*\*) Term: **15 Years**

(21) Appl. No.: **29/699,945**

(22) Filed: **Jul. 30, 2019**

**Related U.S. Application Data**

(62) Division of application No. 29/631,230, filed on Dec. 28, 2017, now abandoned.

(51) **LOC (12) Cl.** ..... **16-05**

(52) **U.S. Cl.**  
USPC ..... **D16/219; D16/218; D16/202**

(58) **Field of Classification Search**  
USPC ..... D16/200–220, 131, 237, 242, 239, 250, D16/235, 130, 134, 136, 238; D14/138 C, 240, 248, 203.1, 203.3, D14/203.7; D10/104.1, 50, 65, 74, 70, D10/118.2  
CPC ... G02B 7/02; G02B 7/04; G02B 7/14; G02B 3/14; G03B 17/00; G03B 17/02; G03B 17/56; G03B 17/04; G03B 17/14; G03B 15/03; G03B 9/08; H04N 5/2251; H04N 5/2252; H04N 5/2253; H04N 5/2254; H04N 7/00; H04N 2101/00; F16M 13/00  
See application file for complete search history.

(56) **References Cited**

**U.S. PATENT DOCUMENTS**

D392,659 S ‡ 3/1998 Takano ..... D16/20  
D407,098 S ‡ 3/1999 Goto ..... D16/20

D487,765 S ‡ 3/2004 Dow ..... D16/20  
D622,591 S \* 8/2010 Biesecker ..... D9/435  
8,014,656 B2 ‡ 9/2011 Woodman ..... B63B 25/002  
396/25  
D657,808 S ‡ 4/2012 Woodman ..... D16/200

(Continued)

*Primary Examiner* — T Chase Nelson

*Assistant Examiner* — Mary Claire Ramirez

(74) *Attorney, Agent, or Firm* — Young Basile Hanlon & MacFarlane, P.C.

(57) **CLAIM**

The ornamental design for a camera, as shown and described.

**DESCRIPTION**

FIG. 1 is a front, top, right perspective view of a camera showing the new design.

FIG. 2 is a front elevation view of the camera shown in FIG. 1.

FIG. 3 is a rear elevation view of the camera shown in FIG. 1.

FIG. 4 is a right elevation view of the camera shown in FIG. 1.

FIG. 5 is a left elevation view of the camera shown in FIG. 1.

FIG. 6 is a top plan view of the camera shown in FIG. 1; and, FIG. 7 is a bottom plan view of the camera shown in FIG. 1.

The broken lines formed by equal length dashes (i.e., dash-dash) depict portions of the camera that form no part of the claimed design. The broken lines formed by unequal length dashes (i.e., dash-dot) define the bounds of the claim and form no part of the claimed design. The camera is shown with symbolic breaks. The appearance of any portion of the camera between the broken away symbols forms no part of the claimed design.

**1 Claim, 6 Drawing Sheets**

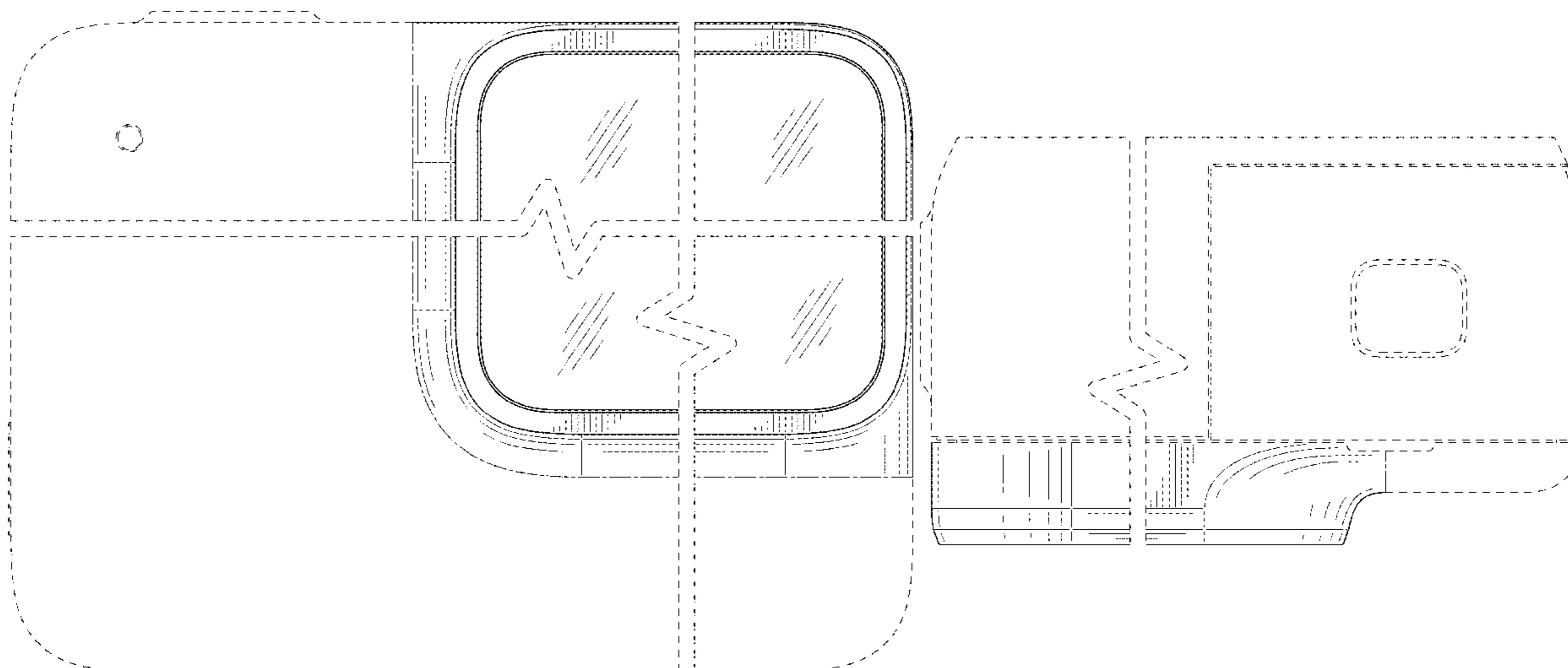

(56)

## References Cited

## U.S. PATENT DOCUMENTS

D664,995	S †	8/2012	Akana	.....	D14/203.3	D789,435	S †	6/2017	Nguyen	.....	D16/20
8,544,643	B2 †	10/2013	Yim	.....	G03B 17/08	D790,001	S †	6/2017	Parfitt	.....	D16/20
					206/31	D790,002	S †	6/2017	Nguyen	.....	D16/21
D710,921	S †	8/2014	Gioscia	.....	D16/20	D791,848	S †	7/2017	Zhu	.....	D16/200
D710,922	S †	8/2014	Gioscia	.....	D16/20	D792,919	S *	7/2017	Ryu	.....	D16/218
8,837,928	B1 *	9/2014	Clearman	.....	E05B 17/2019	D794,696	S †	8/2017	Nguyen	.....	D16/21
					396/25	D798,929	S †	10/2017	Zhou	.....	D16/200
D715,347	S *	10/2014	Troxel	.....	D16/202	D800,202	S †	10/2017	Hu	.....	D16/218
D721,395	S †	1/2015	Woodman	.....	D16/21	D803,705	S †	11/2017	Read	.....	D10/50
D725,169	S †	3/2015	Gioscia	.....	D16/20	D804,560	S †	12/2017	Costa	.....	D16/200
8,992,102	B1 †	3/2015	Samuels	.....	G03B 17/02	D805,117	S †	12/2017	Nguyen	.....	D16/218
					396/41	D805,569	S †	12/2017	Daugela	.....	D16/200
9,033,596	B2 †	5/2015	Samuels	.....	F16F 7/00	D806,775	S †	1/2018	Nguyen	.....	D16/218
					396/421	D808,163	S †	1/2018	Song	.....	D3/269
D732,593	S †	6/2015	Woodman	.....	B63B 25/002	D816,753	S †	5/2018	Zhang	.....	D16/202
					D16/20	D818,028	S †	5/2018	Ramones	.....	D16/214
D733,781	S *	7/2015	Chen	.....	D16/202	D821,480	S †	6/2018	Gioscia	.....	D16/219
D733,788	S *	7/2015	Baker	.....	D16/237	D821,481	S †	6/2018	Gioscia	.....	D16/219
D734,799	S †	7/2015	Woodman	.....	D16/20	D824,982	S †	8/2018	Lee	.....	D16/202
D737,879	S †	9/2015	Woodman	.....	D16/21	D832,905	S †	11/2018	Liu	.....	D16/202
D739,451	S †	9/2015	Gioscia	.....	D16/20	D832,906	S †	11/2018	Hasegawa	.....	D16/203
D740,868	S *	10/2015	Gioscia	.....	D16/200	D836,696	S †	12/2018	Zhang	.....	D16/202
D741,394	S †	10/2015	Gioscia	.....	D16/200	D837,861	S †	1/2019	Luo	.....	D16/200
D741,932	S †	10/2015	Huang	.....	D16/202	D839,335	S †	1/2019	Zhang	.....	D16/202
D742,952	S †	11/2015	Nakajima	.....	D16/20	D840,463	S †	2/2019	Nguyen	.....	D16/218
D744,572	S †	12/2015	Tabuchi	.....	D16/218	D842,142	S †	3/2019	Recker	.....	D10/70
D745,589	S *	12/2015	Lee	.....	D16/218	D849,084	S †	5/2019	Hu	.....	D16/202
D750,146	S †	2/2016	Costa	.....	D16/20	D849,730	S †	5/2019	Charette	.....	D14/240
D750,680	S †	3/2016	Chen	.....	D16/20	D850,513	S *	6/2019	Gan	.....	D16/218
D750,686	S †	3/2016	Chen	.....	D16/21	D852,255	S *	6/2019	Guo	.....	D16/202
D750,687	S †	3/2016	Samuels	.....	G03B 17/02	D855,675	S †	8/2019	Luo	.....	D16/202
					D16/21	D861,761	S *	10/2019	Bergman	.....	D16/200
D751,131	S †	3/2016	Woodman	.....	D16/21	D861,766	S *	10/2019	Lim	.....	D16/237
D753,749	S †	4/2016	Zhu	.....	D16/20	D865,843	S *	11/2019	Hu	.....	D16/218
D755,270	S †	5/2016	Vehlewald	.....	D16/20	D868,871	S *	12/2019	Nguyen	.....	D16/218
D755,874	S †	5/2016	Yang	.....	D16/20	D871,480	S *	12/2019	Hu	.....	D16/202
D758,467	S †	6/2016	Zhang	.....	D16/20	2007/0019948	A1 †	1/2007	Terada	.....	G03B 17/04
D760,309	S †	6/2016	Parfitt	.....	D16/20						396/349
9,360,742	B1 †	6/2016	Harrison	.....	G03B 17/561	2015/0022717	A1 *	1/2015	Coons	.....	E05C 19/14
9,395,031	B1 *	7/2016	Clearman	.....	F16M 13/00						348/373
D762,759	S †	8/2016	Wu	.....	D16/21	2016/0119516	A1 *	4/2016	Clearman	.....	G03B 17/02
D763,346	S †	8/2016	Jenkins	.....	D18/4						348/373
D769,346	S †	10/2016	Nguyen	.....	D16/21	2016/0131963	A1 *	5/2016	Clearman	.....	G03B 17/561
9,507,245	B1 *	11/2016	Druker	.....	G03B 17/566						224/267
D773,546	S †	12/2016	Nguyen	.....	D16/21	2017/0059967	A1 †	3/2017	Harrison	.....	G03B 17/561
D773,547	S *	12/2016	Lee	.....	D16/218	2017/0150236	A1 †	5/2017	Newman	.....	H04N 5/91
D775,254	S †	12/2016	Parfitt	.....	D16/20	2017/0195550	A1 †	7/2017	Kim	.....	G06F 3/0483
D776,741	S †	1/2017	Parfitt	.....	D16/20	2017/0289413	A1 †	10/2017	Samuels	.....	G03B 17/02
D777,236	S *	1/2017	Mai	.....	D16/218	2017/0324890	A1 †	11/2017	Moskovchenko	...	H04N 5/2252
D777,821	S *	1/2017	Gioscia	.....	D16/219	2018/0039162	A1 †	2/2018	Ali	.....	G03B 17/55
D778,335	S †	2/2017	Gioscia	.....	D16/20	2018/0081258	A1 †	3/2018	Clyne	.....	G03B 17/08
D778,336	S †	2/2017	Gioscia	.....	D16/21	2018/0084194	A1 †	3/2018	Woodman	.....	H04N 5/23241
D779,576	S *	2/2017	Ikegame	.....	D16/211	2018/0084215	A1 †	3/2018	Jing	.....	H04N 5/225
D785,696	S †	5/2017	Parfitt	.....	D16/242	2018/0102123	A1 †	4/2018	Tisch	.....	H04R 1/08
D785,697	S †	5/2017	Costa	.....	D16/242	2018/0103189	A1 †	4/2018	Nguyen	.....	H04N 5/23206
D788,835	S †	6/2017	Wu	.....	D16/21	2018/0103190	A1 †	4/2018	Nguyen	.....	H04N 5/23206
						2018/0198989	A1 †	7/2018	Macmillan	.....	H04N 5/247

\* cited by examiner

† imported from a related application

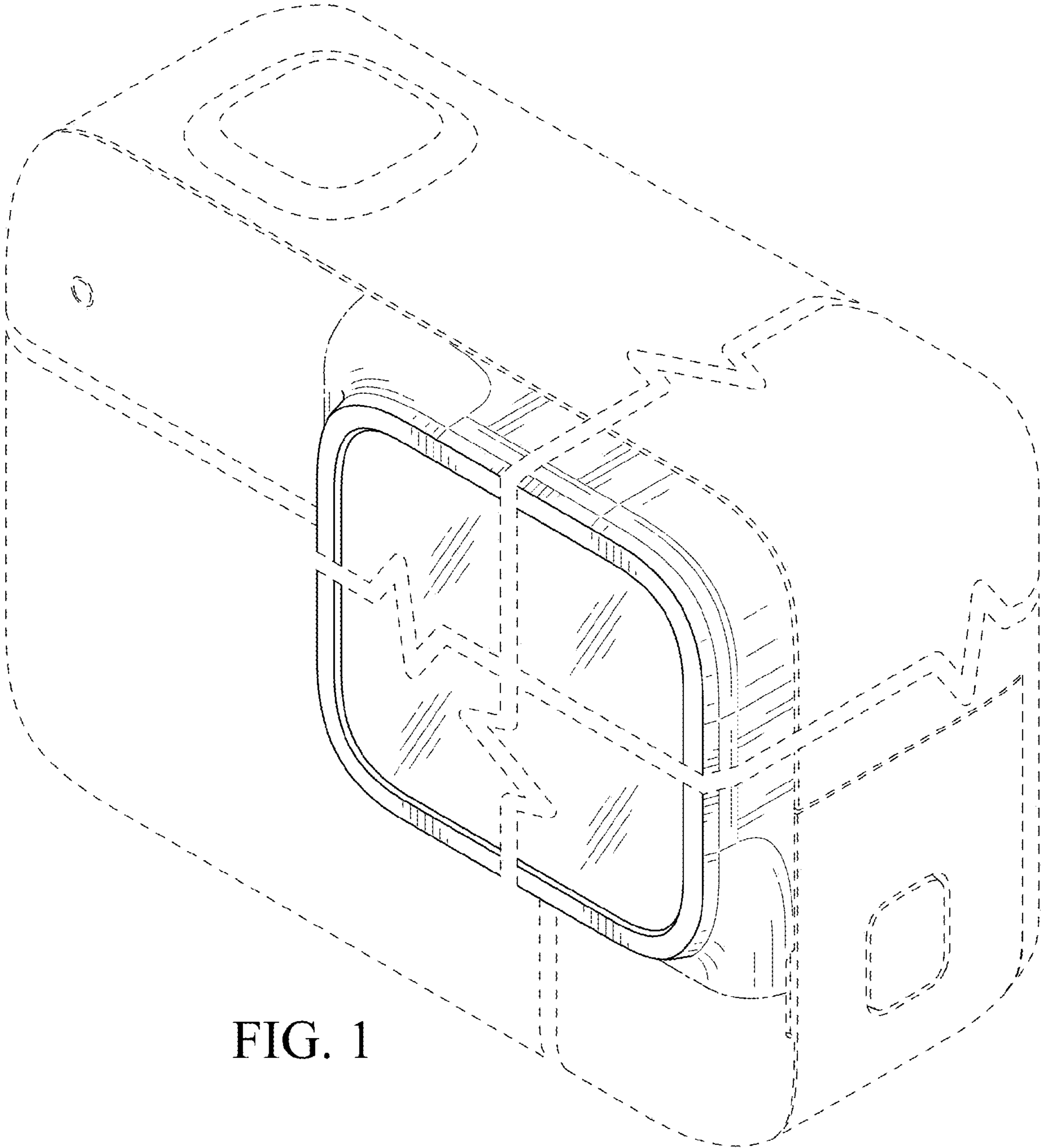

FIG. 1

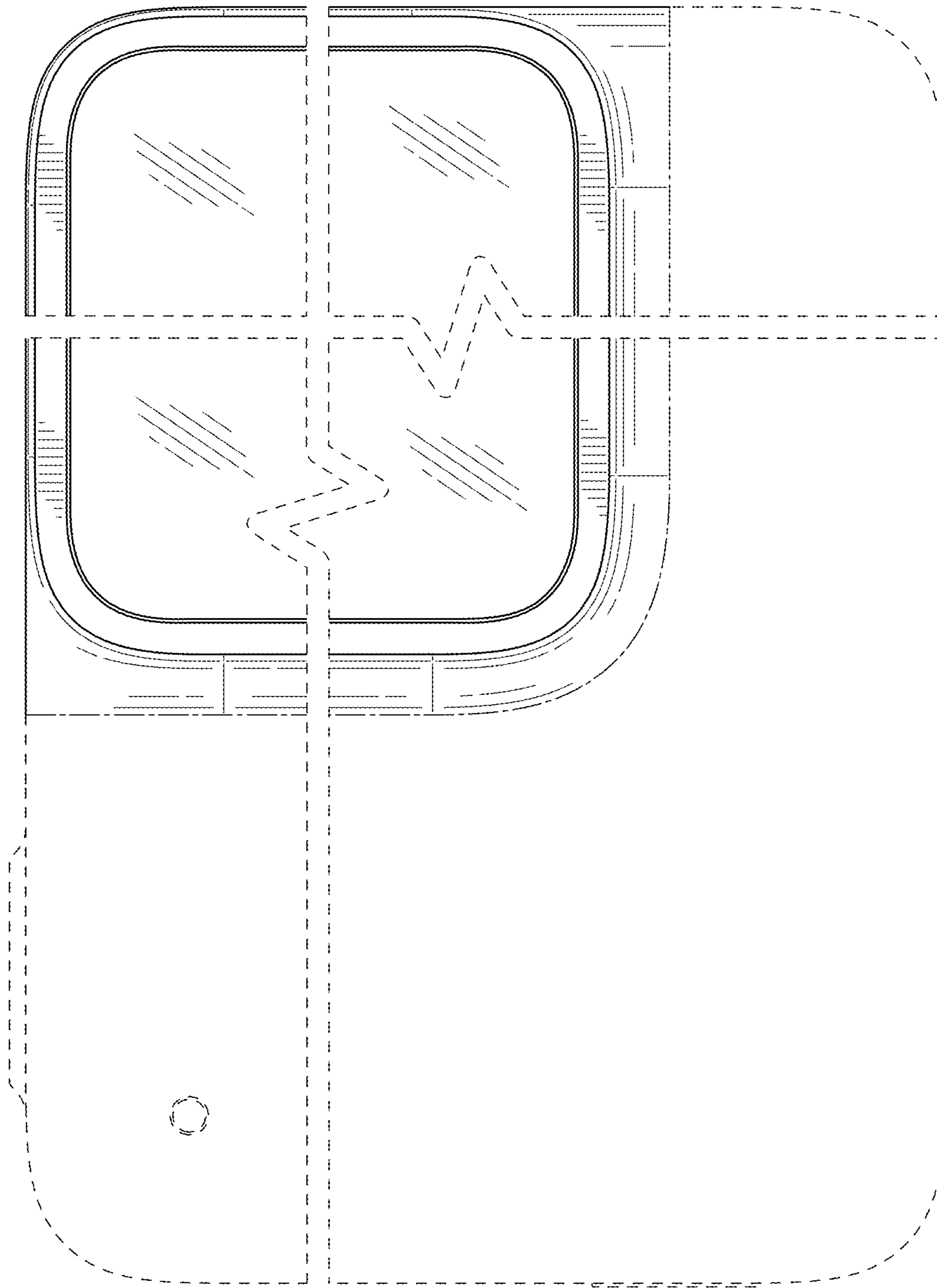

FIG. 2

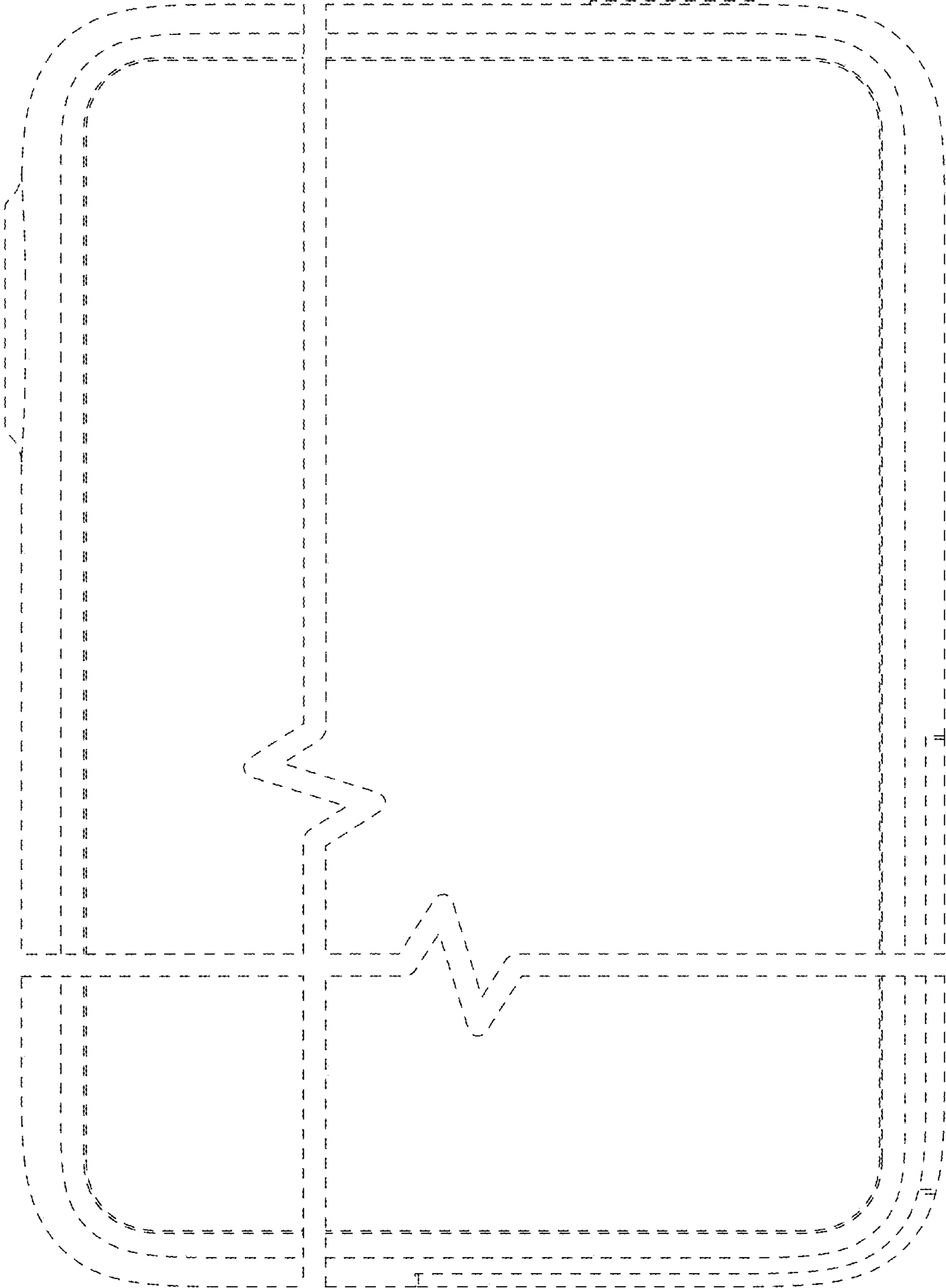

FIG. 3

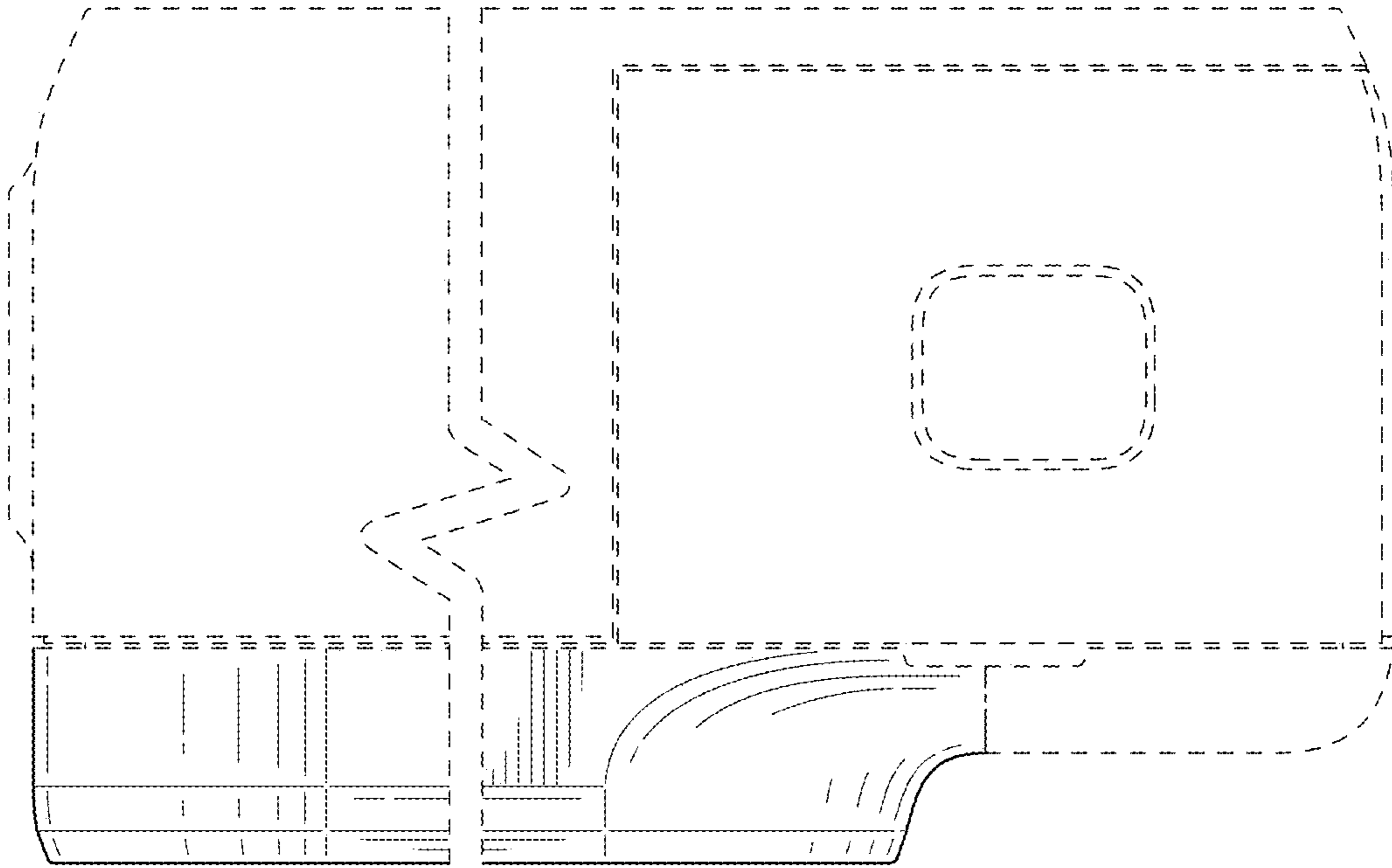

FIG. 4

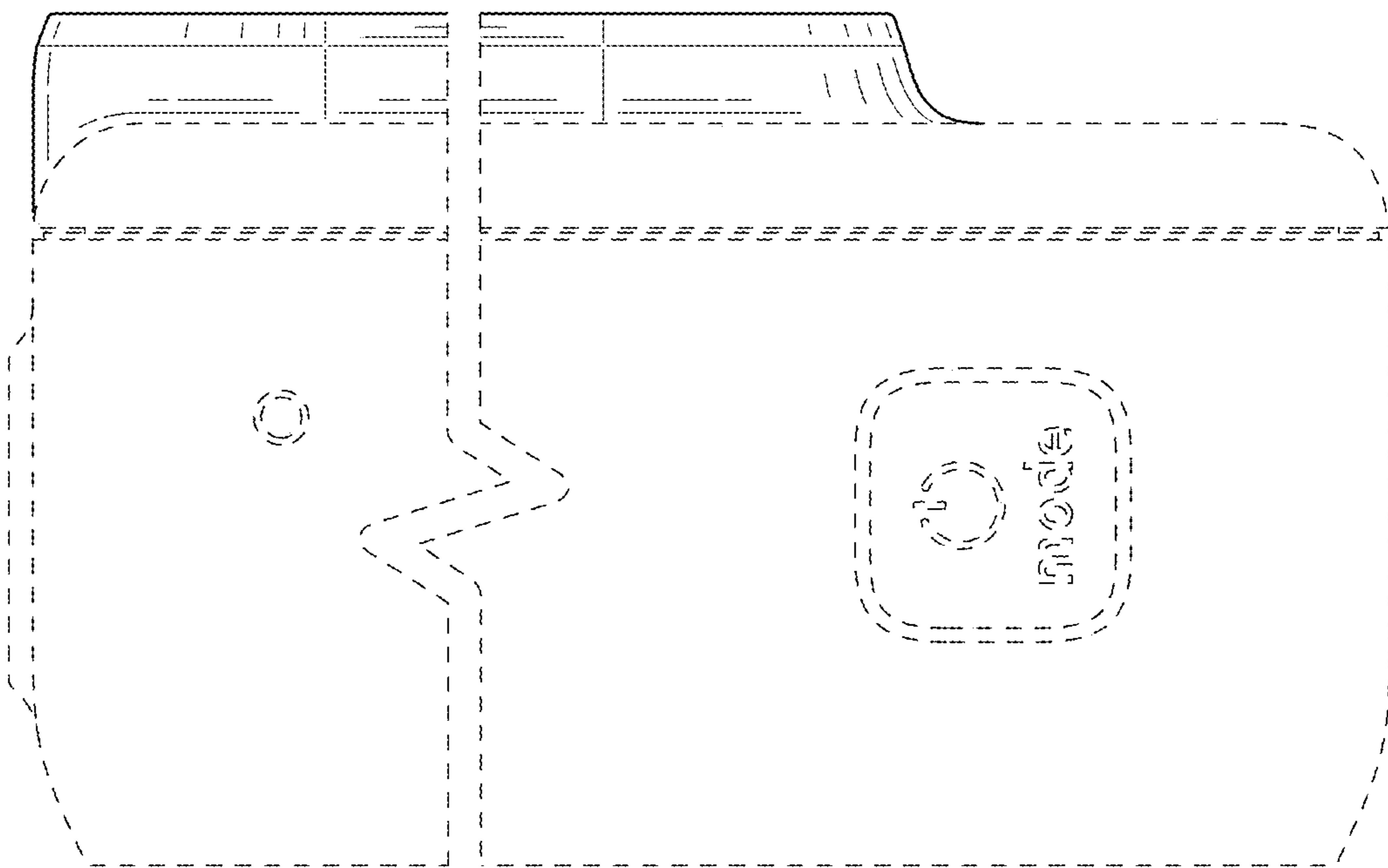

FIG. 5

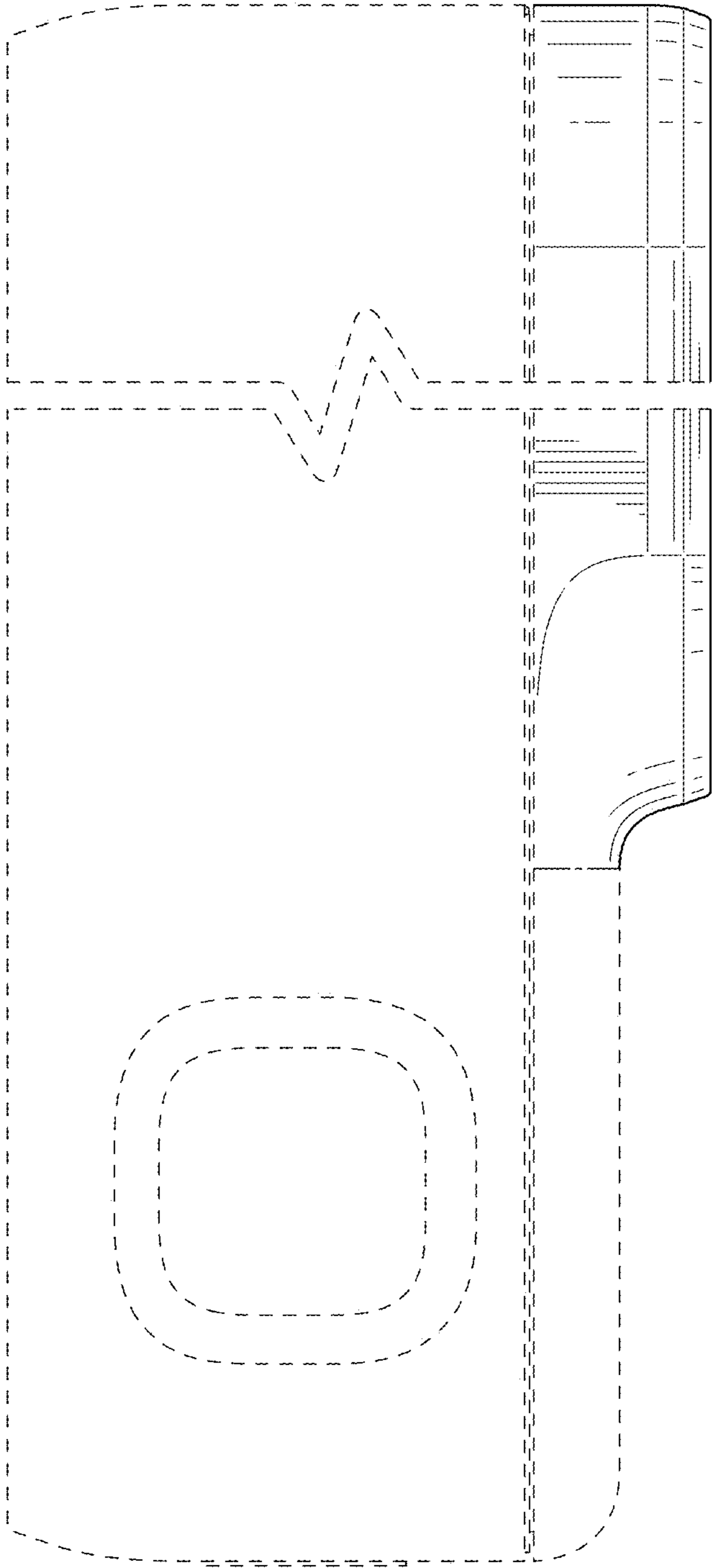

FIG. 6

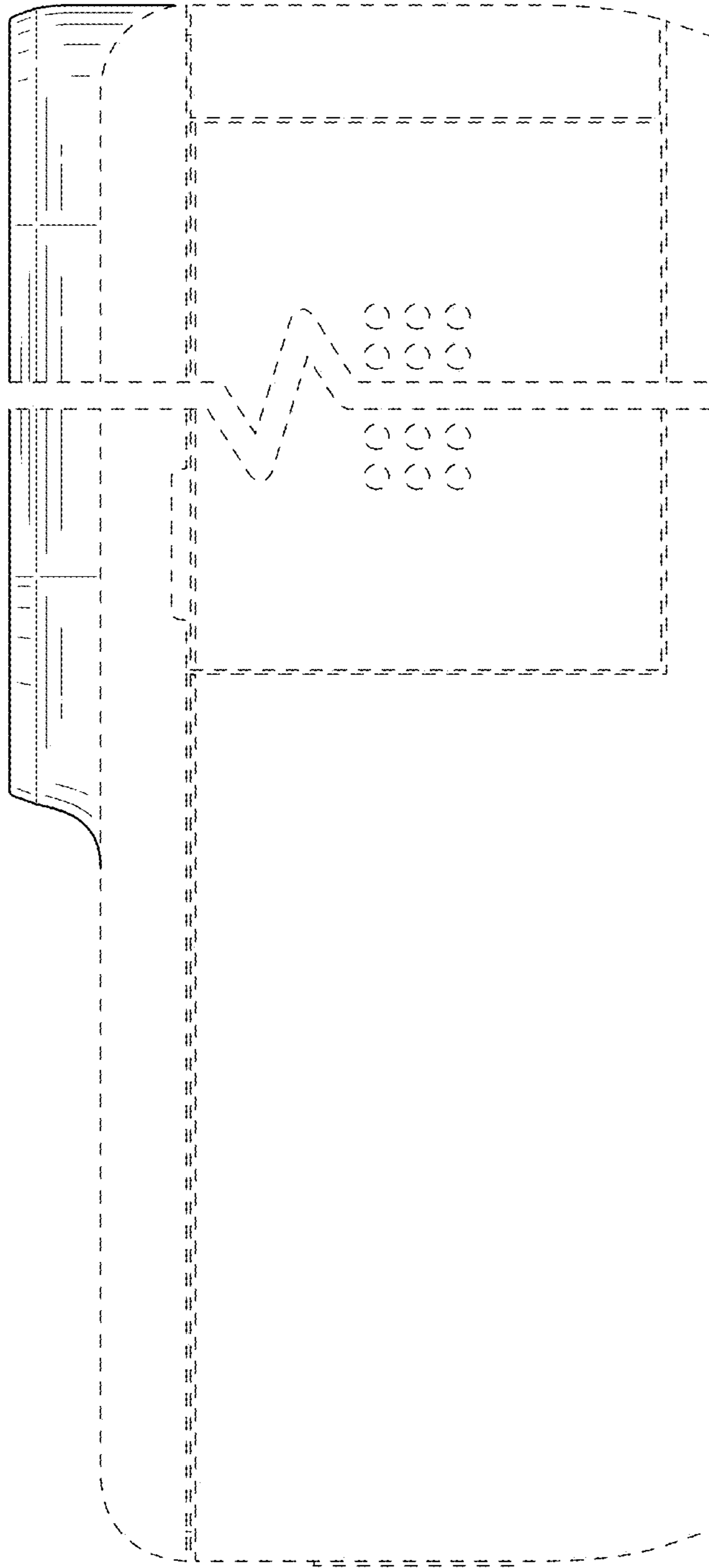

FIG. 7