

US00D890637S

(12) **United States Design Patent**
McCuskey

(10) **Patent No.:** **US D890,637 S**

(45) **Date of Patent:** **** Jul. 21, 2020**

- (54) **DROP DOWN TRAILER HITCH**
- (71) Applicant: **Scott McCuskey**, Boardman, OH (US)
- (72) Inventor: **Scott McCuskey**, Boardman, OH (US)
- (**) Term: **15 Years**
- (21) Appl. No.: **29/679,812**
- (22) Filed: **Feb. 11, 2019**
- (51) **LOC (12) Cl.** **12-16**
- (52) **U.S. Cl.**
USPC **D12/162**
- (58) **Field of Classification Search**
USPC D12/159-162
CPC . B60D 1/60; B60D 1/065; B60D 1/00; B60D
1/06; B60D 1/36
See application file for complete search history.

- D857,565 S * 8/2019 McCuskey D12/162
- D862,306 S * 10/2019 Porath B60D 1/605
D12/162
- D862,308 S * 10/2019 Siegel D12/162
- D873,723 S * 1/2020 Borkholder D12/162
- D876,290 S * 2/2020 Kirkland D12/162
- D881,078 S * 4/2020 Rebick D12/162

* cited by examiner

Primary Examiner — Katrina A Betton

(74) *Attorney, Agent, or Firm* — Harpman & Harpman

(57) **CLAIM**

The ornamental design for a drop down trailer hitch, as shown and described.

DESCRIPTION

FIG. 1 is a front and right side perspective view of a fixed drop down trailer hitch showing my new design;
 FIG. 2 is a right side elevational view thereof;
 FIG. 3 is a left side elevational view thereof;
 FIG. 4 is a top plan view thereof;
 FIG. 5 is a bottom plan view thereof;
 FIG. 6 is a rear elevational view thereof;
 FIG. 7 is a front elevational view thereof; and,
 FIG. 8 is a front and right side perspective view of the fixed drop down trailer hitch with related environment in broken lines. The broken lines form no part of the claim and are shown only as relatable environment.

(56) **References Cited**

U.S. PATENT DOCUMENTS

- D794,515 S * 8/2017 McCuskey D12/162
- D847,697 S * 5/2019 McCuskey D12/162
- D851,545 S * 6/2019 McCuskey D12/162
- D851,546 S * 6/2019 McCuskey D12/162
- D854,970 S * 7/2019 McCuskey D12/162
- D857,564 S * 8/2019 McCuskey D12/162

1 Claim, 6 Drawing Sheets

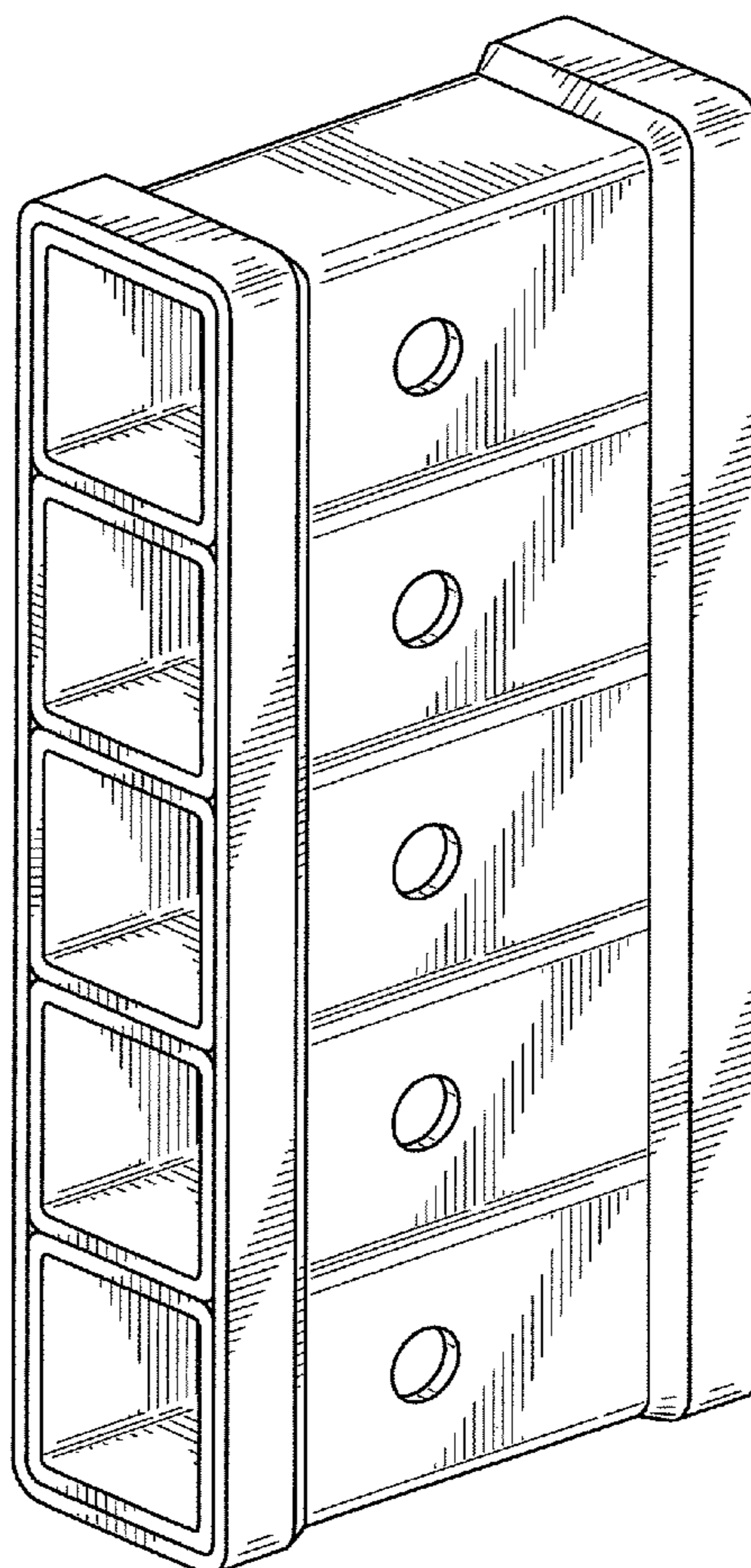

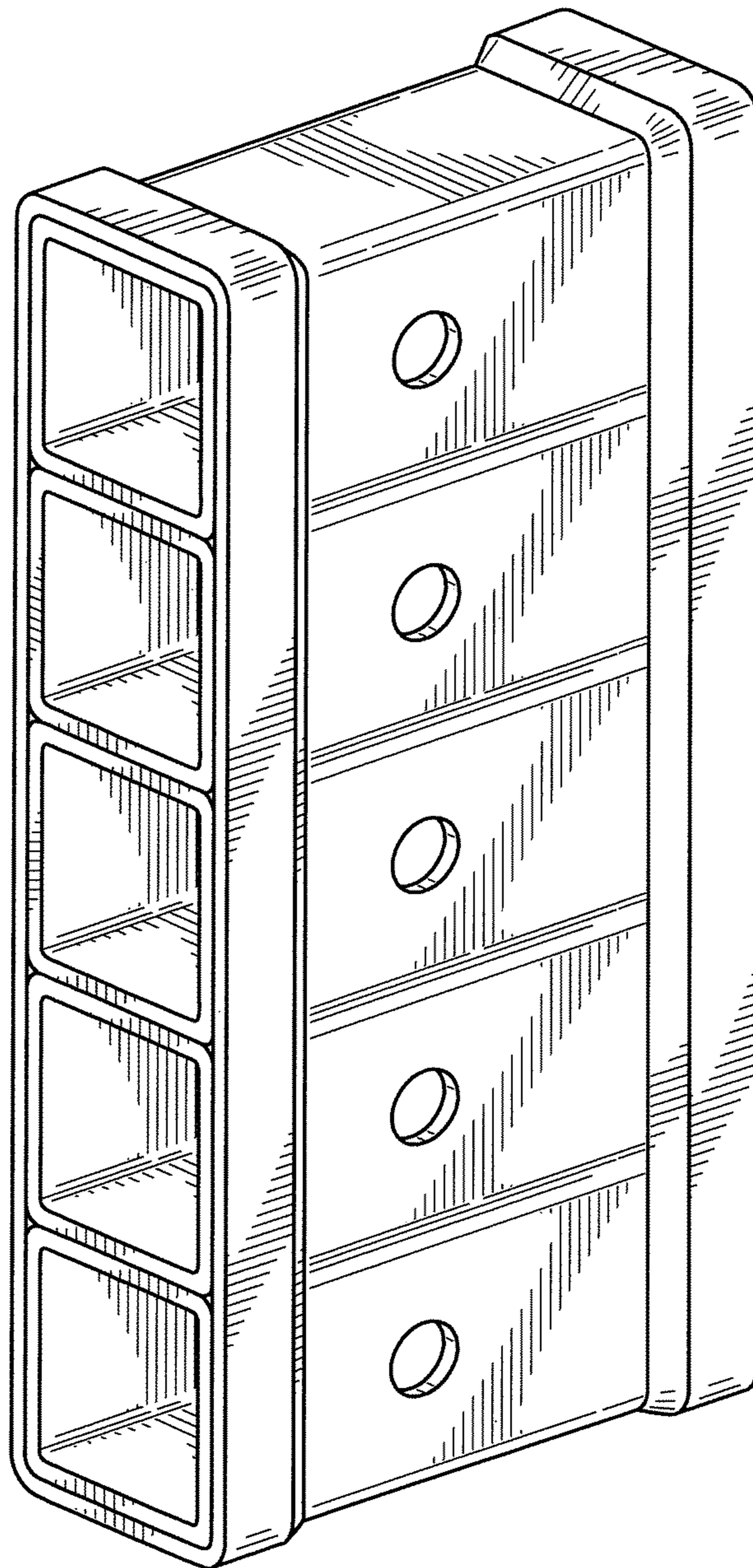

FIG. 1

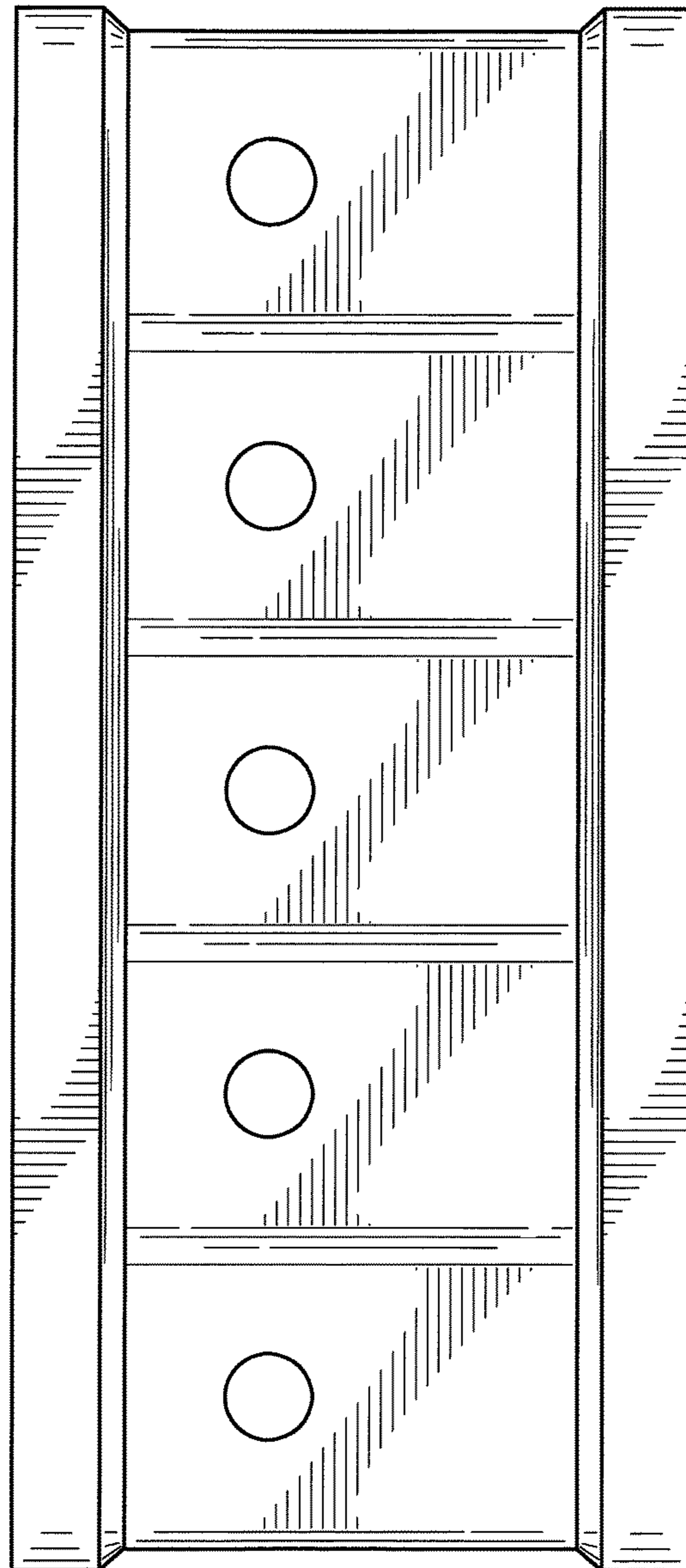

FIG. 2

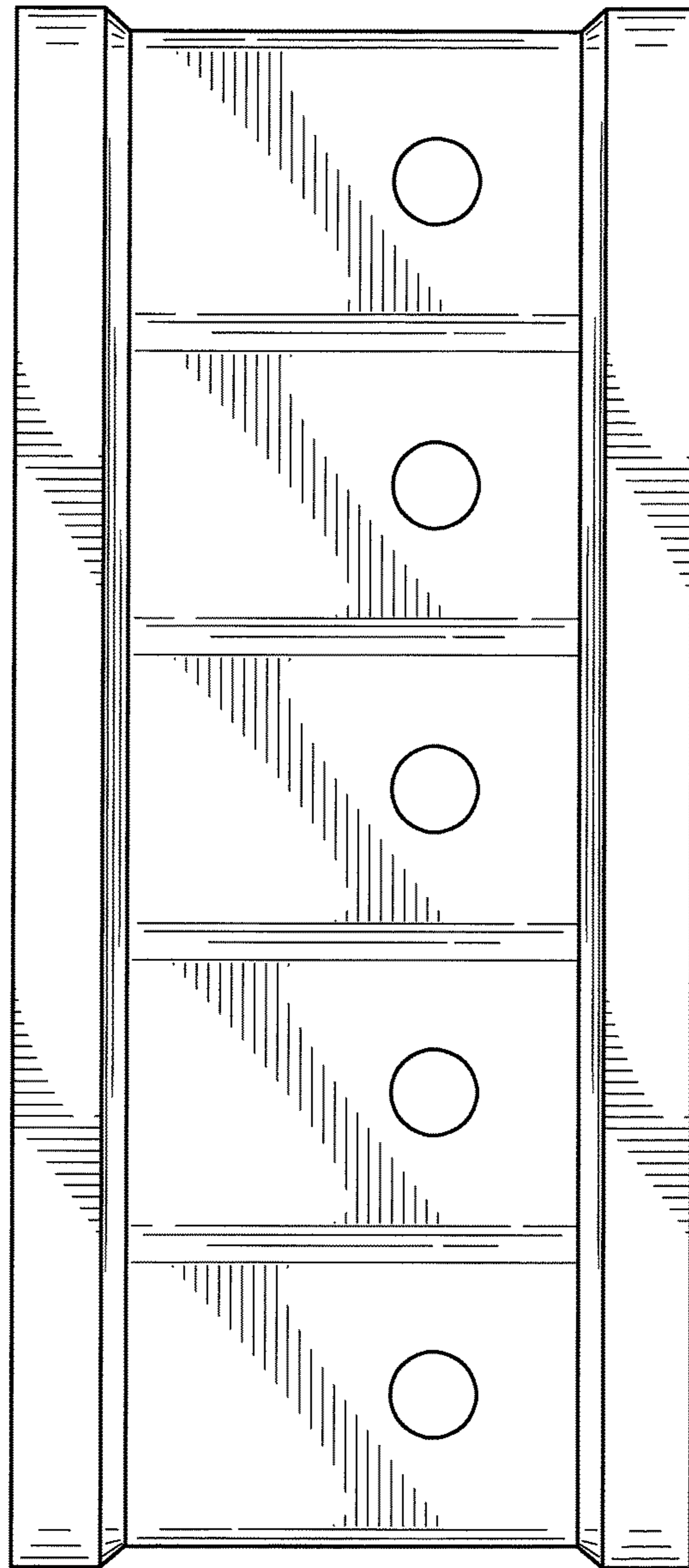

FIG. 3

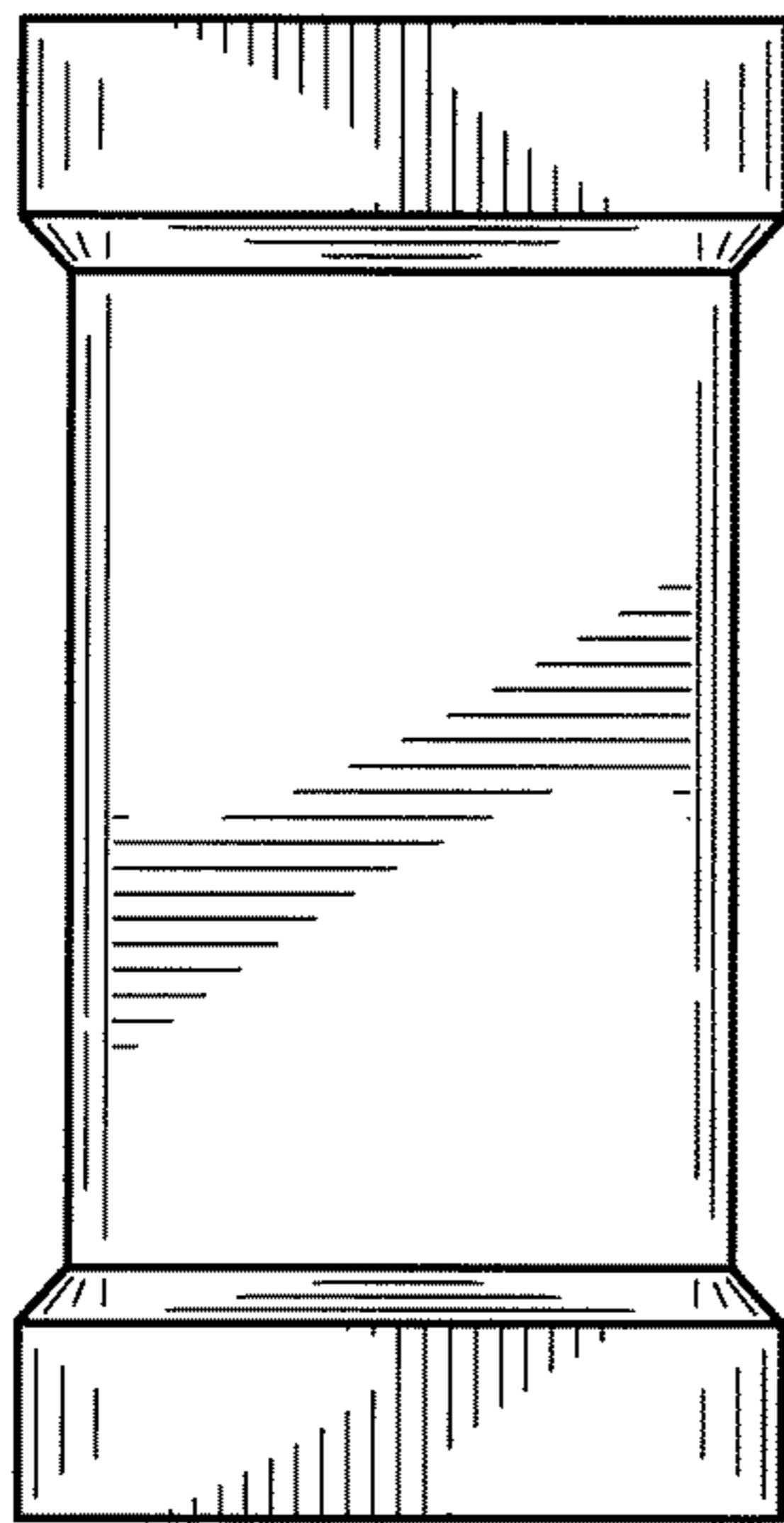

FIG. 4

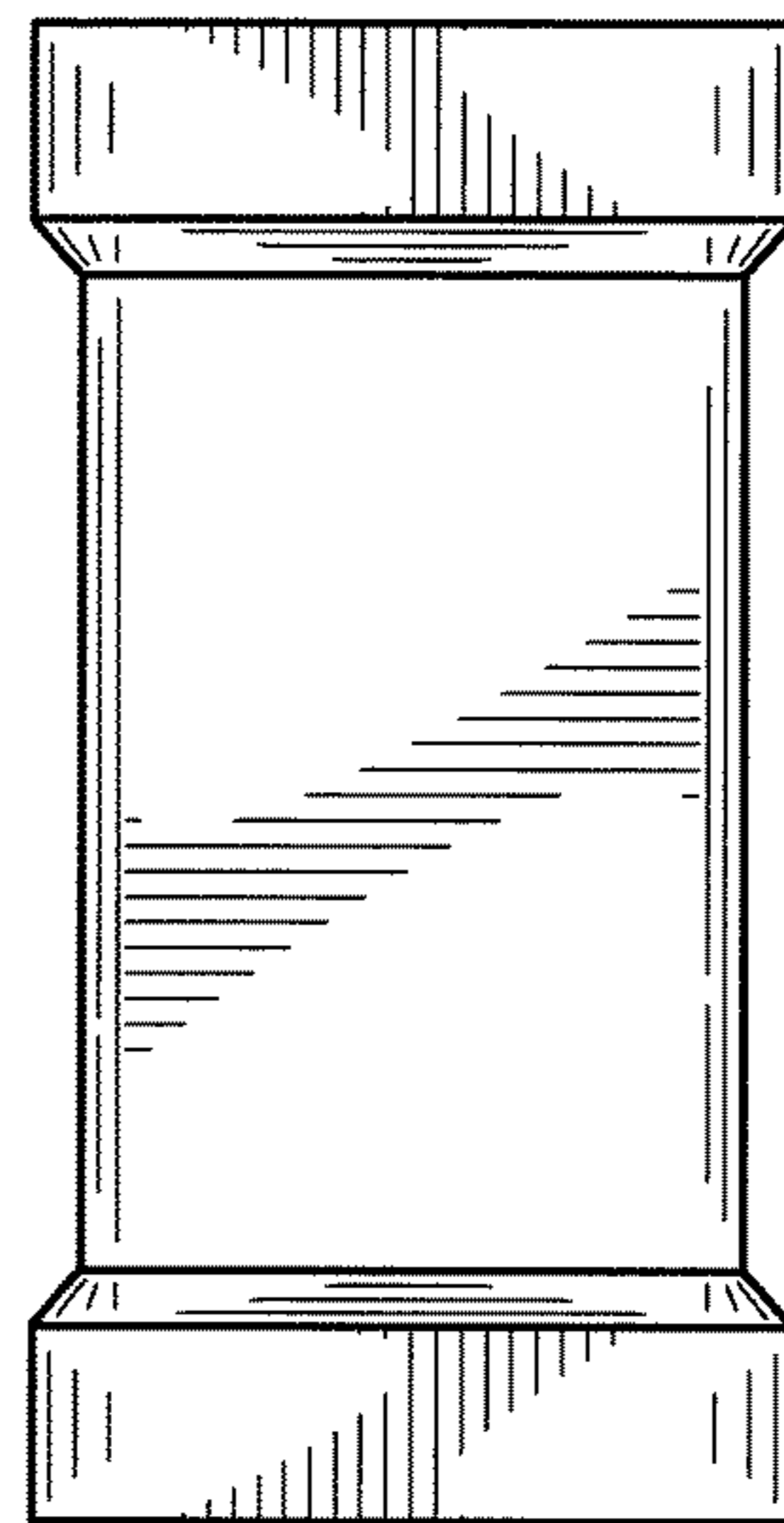

FIG. 5

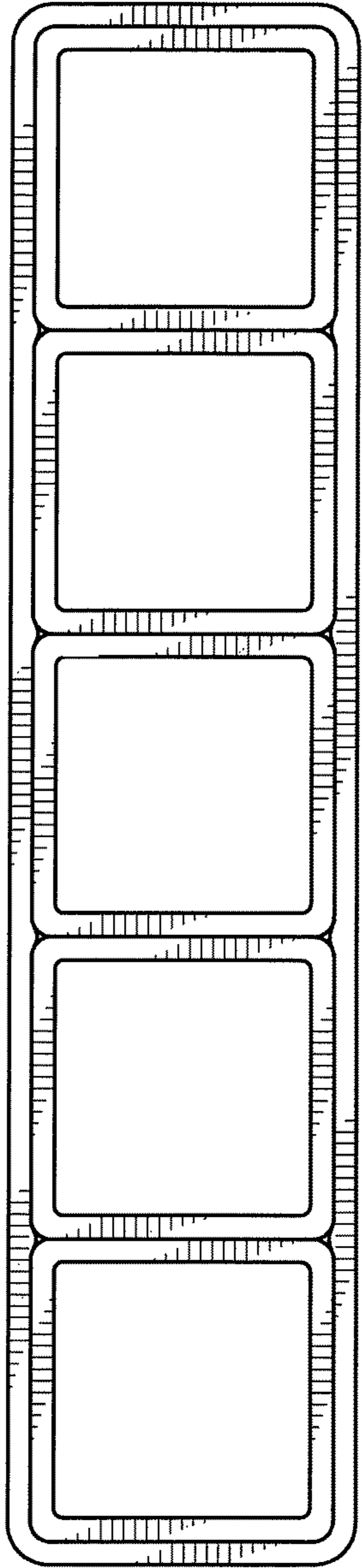

FIG. 6

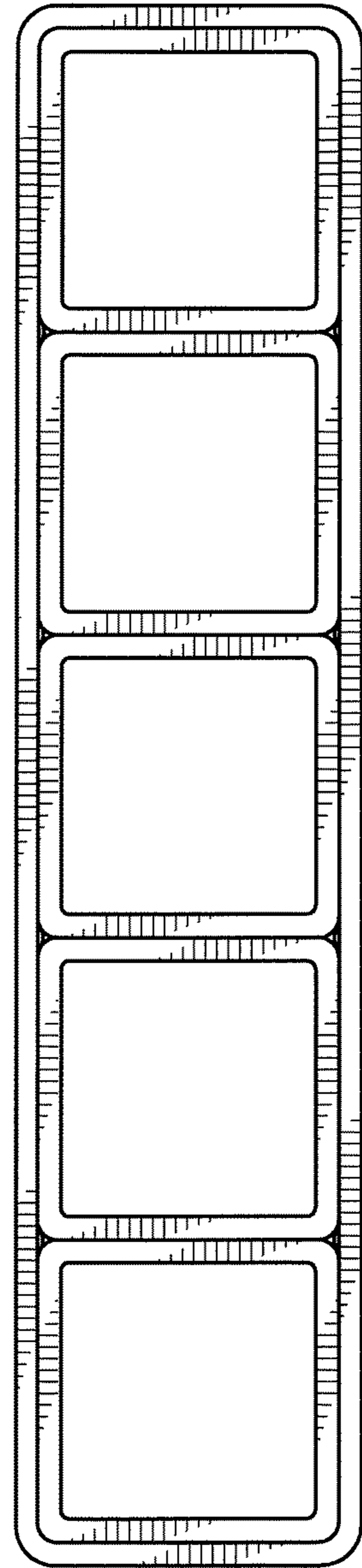

FIG. 7

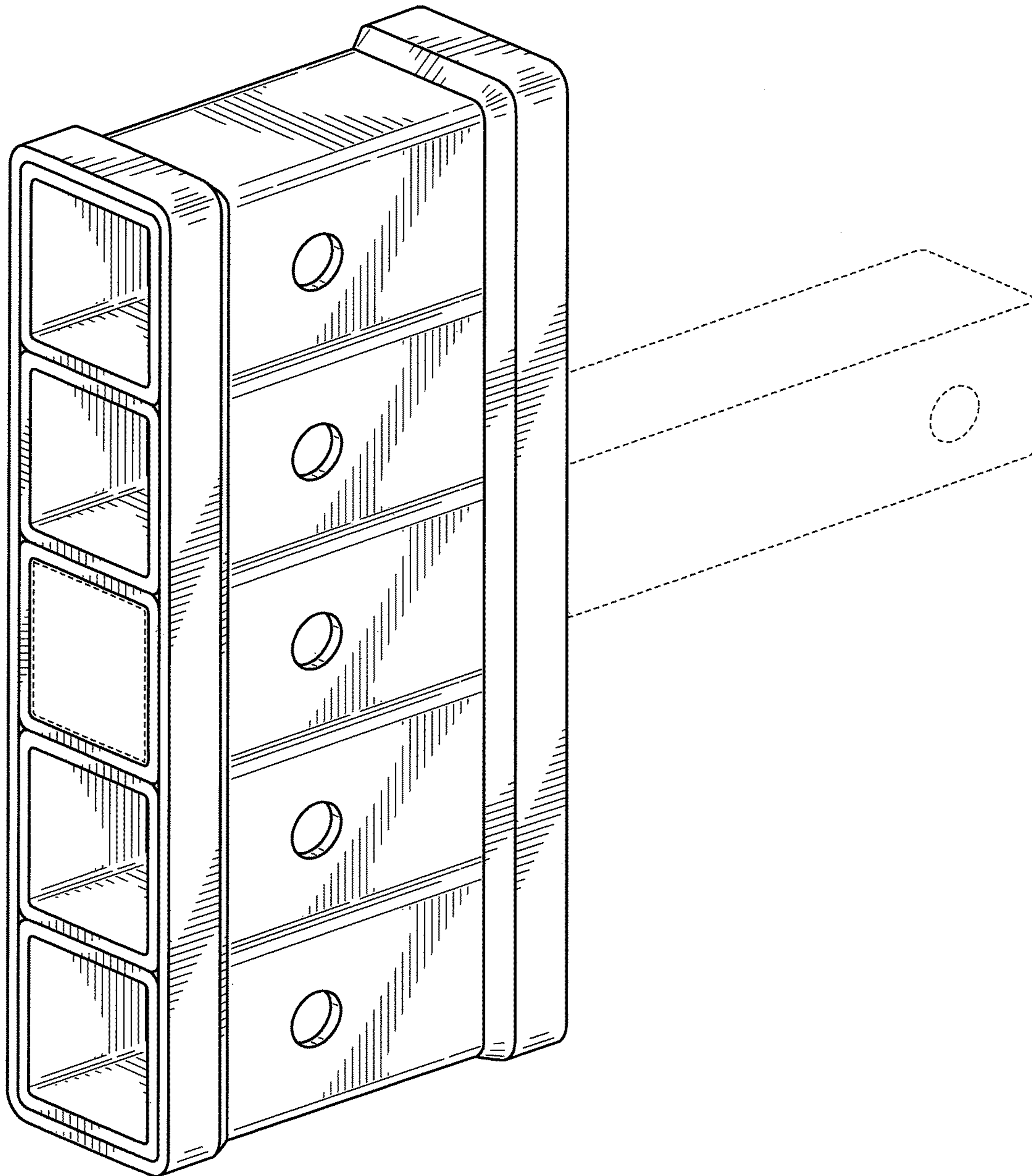

FIG. 8