



US00D890496S

(12) **United States Design Patent**
Le

(10) **Patent No.:** **US D890,496 S**
(45) **Date of Patent:** **** Jul. 21, 2020**

(54) **SHOE**
(71) Applicant: **PUMA SE**, Herzogenaurach (DE)
(72) Inventor: **Thomas Le**, Boston, MA (US)
(73) Assignee: **PUMA SE**, Herzogenaurach (DE)
(**) Term: **15 Years**

D263,518 S 3/1982 Cohen
D265,019 S 6/1982 Vermonet
4,345,387 A 8/1982 Daswick
(Continued)

FOREIGN PATENT DOCUMENTS

CN 303732506 S 7/2016
EM 002219956-0020 S 4/2013

OTHER PUBLICATIONS

Hi Octn Sports Design Men's Motorsport Shoes, Puma.com, [online], [site visited Mar. 24, 2020]. <URL: https://us.puma.com/en/us/pd/hi-octn-sports-design-mens-motorsport-shoes/372106.html?dwvar_372106_color=02> (Year: 2020).*

(Continued)

Primary Examiner — T Chase Nelson
Assistant Examiner — Jonathan J. Han
(74) *Attorney, Agent, or Firm* — Quarles & Brady LLP

(21) Appl. No.: **29/680,242**
(22) Filed: **Feb. 14, 2019**
(51) **LOC (12) Cl.** **02-04**
(52) **U.S. Cl.**
USPC **D2/959**; D2/947; D2/948; D2/951;
D2/957; D2/960
(58) **Field of Classification Search**
USPC D2/902, 906, 908, 916, 918, 925,
D2/946-962, 977; 36/1, 1.5, 3 B, 22 R,
36/24.5, 25 R, 28, 32 R, 34 R, 59 C,
36/67 A, 103, 101-107, 114-116, 117.3,
36/117.4, 124-136
CPC A43B 13/00; A43B 13/02; A43B 13/023;
A43B 13/026; A43B 13/04; A43B 13/08;
A43B 13/10; A43B 13/12; A43B 13/14;
A43B 13/141; A43B 13/143; A43B
13/16; A43B 13/18; A43B 13/181; A43B
13/187; A43B 13/189; A43B 13/20; A43B
13/22; A43B 13/223; A43B 13/24; A43B
13/28; A43B 13/30; A43B 13/32; A43B
13/34; A43B 13/36
See application file for complete search history.

(57) **CLAIM**

The ornamental design for a shoe, as shown and described.

DESCRIPTION

FIG. 1 is a top, left, and front perspective view of an ornamental design for a shoe;
FIG. 2 is a front elevational view of the shoe of FIG. 1;
FIG. 3 is a rear elevational view of the shoe of FIG. 1;
FIG. 4 is a left side elevational view of the shoe of FIG. 1;
FIG. 5 is a right side elevational view of the shoe of FIG. 1;
FIG. 6 is a top plan view of the shoe of FIG. 1;
FIG. 7 is a bottom plan view of the shoe of FIG. 1; and,
FIG. 8 is a bottom, right, and rear perspective view of the shoe of FIG. 1.

The dash-dash-dash broken lines are included for the purpose of illustrating portions of the shoe that form no part of the claimed design.

1 Claim, 8 Drawing Sheets

(56) **References Cited**
U.S. PATENT DOCUMENTS
2,090,881 A 8/1937 Wilson
D237,323 S 10/1975 Inohara
D244,967 S 7/1977 Famolare, Jr.
4,089,069 A 5/1978 Vistins
D263,348 S 3/1982 Cohen

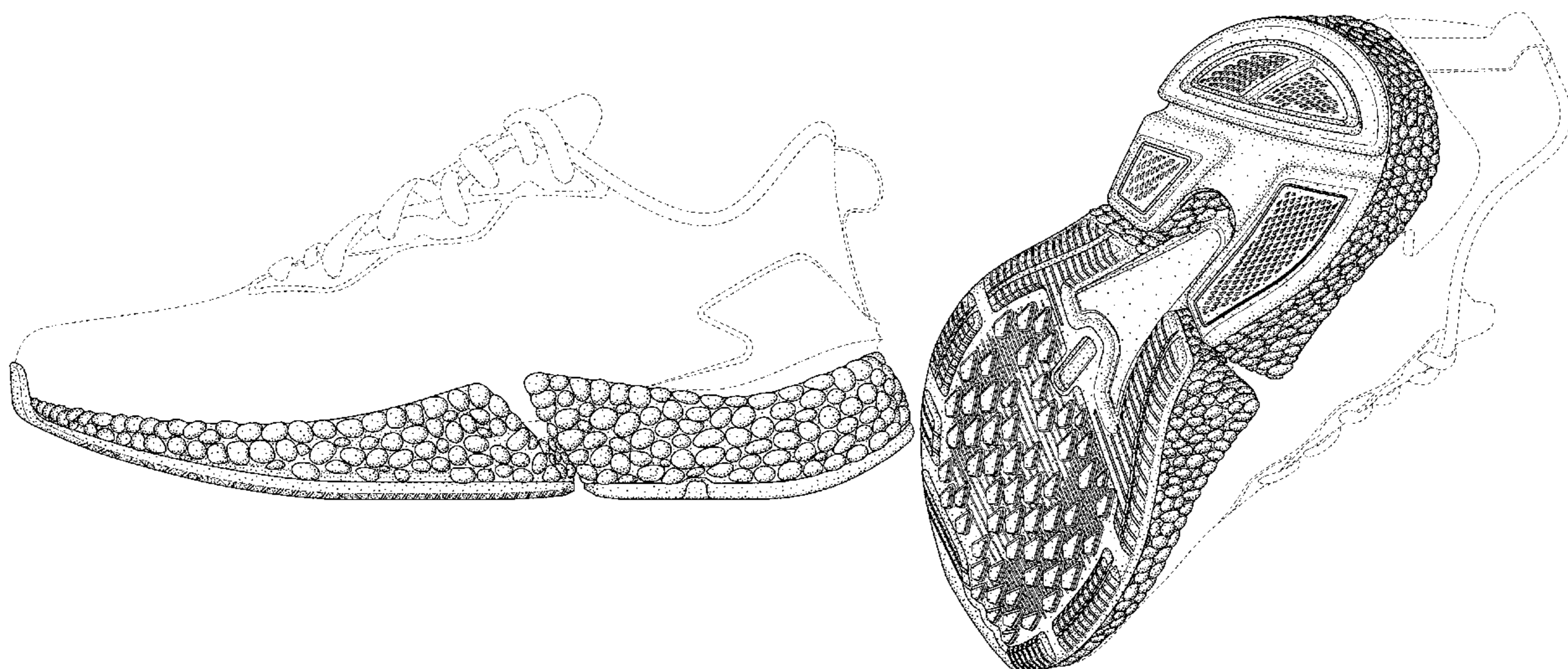

(56)

References Cited

U.S. PATENT DOCUMENTS

4,378,641	A	4/1983	Tarlow	D581,634	S	12/2008	Hickman	
D297,682	S	9/1988	Le	D586,090	S	2/2009	Turner et al.	
D305,278	S	1/1990	Kiyosawa	D596,384	S	7/2009	Andersen et al.	
D306,372	S	3/1990	Diaz et al.	D597,286	S	8/2009	Della Valle et al.	
D307,971	S	5/1990	Maccano et al.	D601,333	S	10/2009	McClaskie	
D319,337	S	8/1991	Hatfield	D606,733	S	12/2009	McClaskie	
D321,973	S	12/1991	Hatfield	D607,190	S	1/2010	McClaskie	
D323,059	S	1/1992	Hatfield	D607,634	S	1/2010	Andersen et al.	
D327,164	S	6/1992	Hatfield	7,703,219	B2	4/2010	Beck	
D327,976	S	7/1992	Biotteau	D631,239	S	1/2011	Loverin et al.	
D329,528	S	9/1992	Hatfield	D631,646	S	2/2011	Muller	
D334,279	S	3/1993	Teague	D633,286	S	3/2011	Skaja	
D350,222	S	9/1994	Hase	D634,918	S	3/2011	Katz et al.	
D353,708	S	12/1994	Crowley, II	D636,571	S	4/2011	Avar	
D353,935	S	1/1995	Pollack	D636,588	S	4/2011	Avar	
D356,438	S	3/1995	Opie et al.	D641,142	S	7/2011	Lindseth et al.	
D357,347	S	4/1995	Leick	D642,777	S	8/2011	Walsh et al.	
D373,013	S	8/1996	Rosetta	D644,418	S	9/2011	Yi	
D379,113	S	5/1997	McDonald et al.	D645,649	S	9/2011	McClaskie	
D379,114	S	5/1997	Merceron	D645,650	S	9/2011	McClaskie	
D382,692	S	8/1997	Carlson	D650,567	S	12/2011	Badegruber	
D389,991	S	2/1998	Elliott	D655,487	S	3/2012	Blakeslee	
D390,349	S	2/1998	Murai et al.	D662,695	S	7/2012	McVicker et al.	
D391,748	S	3/1998	Koh	D663,933	S	7/2012	Lane	
D392,446	S	* 3/1998	Fogg D2/954	D664,340	S	7/2012	McClaskie	
D393,538	S	4/1998	Marshall	D664,750	S	8/2012	McClaskie	
D394,342	S	* 5/1998	Schneider D2/959	D666,392	S	* 9/2012	Shaffer D2/951	
D394,742	S	6/1998	Gaudio	D671,718	S	12/2012	McVicker et al.	
D394,945	S	6/1998	Doxey	D672,543	S	12/2012	Williams, Jr.	
D395,738	S	7/1998	Hatfield et al.	D680,710	S	4/2013	Sundberg	
D414,920	S	10/1999	Cahill	D684,343	S	6/2013	Sundberg	
D415,610	S	10/1999	Cahill	D684,344	S	6/2013	Sundberg	
6,035,554	A	3/2000	Duncan	8,533,977	B2	9/2013	Hide et al.	
D423,199	S	4/2000	Cahill	D690,490	S	10/2013	Riddell	
D424,287	S	5/2000	Edwards	D693,553	S	11/2013	McClaskie	
D429,874	S	8/2000	Gumbert	D702,031	S	* 4/2014	Nakano D2/951	
D432,294	S	10/2000	Wilson	D708,829	S	7/2014	Taylor	
D433,560	S	11/2000	Pawlus	D709,680	S	7/2014	Herath	
6,187,837	B1	2/2001	Pearce	D710,078	S	* 8/2014	Joseph D2/951	
6,199,302	B1	3/2001	Kayano	D713,624	S	9/2014	Petrie	
D440,032	S	4/2001	Madden	D717,033	S	* 11/2014	Law D2/951	
D441,519	S	5/2001	Erickson et al.	D721,478	S	1/2015	Avent et al.	
D444,620	S	7/2001	Della Valle	D722,425	S	2/2015	Cin	
D445,561	S	7/2001	Bramani	D724,296	S	* 3/2015	Law D2/951	
D447,616	S	9/2001	Bandini et al.	D728,912	S	5/2015	Taestensen	
6,314,661	B1	11/2001	Chern	D729,393	S	5/2015	Dunn et al.	
D460,852	S	7/2002	Daudier	D733,411	S	7/2015	Lonigan	
D465,079	S	11/2002	Merceron	D733,412	S	7/2015	Lonigan	
D466,272	S	12/2002	Erickson et al.	D733,413	S	7/2015	Joseph	
D494,343	S	8/2004	Morris	D734,006	S	7/2015	Portzline	
D496,149	S	9/2004	Belley et al.	D735,983	S	8/2015	Cietto	
D496,525	S	9/2004	Dykstra	D737,548	S	9/2015	Levy	
D497,047	S	* 10/2004	Munns D2/958	D738,602	S	9/2015	Qin	
D503,522	S	4/2005	Schoenborn et al.	D739,129	S	9/2015	Del Biondi	
6,957,504	B2	10/2005	Morris	D739,131	S	9/2015	Del Biondi	
D513,836	S	1/2006	Magro et al.	D739,132	S	9/2015	Del Biondi	
D530,893	S	10/2006	Sonnergren	D740,003	S	10/2015	Herath	
D540,517	S	4/2007	McClaskie	D740,004	S	10/2015	Hoellmueller et al.	
D549,937	S	9/2007	Matis et al.	D743,151	S	11/2015	Toliver	
D550,431	S	* 9/2007	Schoenborn D2/952	D743,152	S	11/2015	Toliver	
D552,337	S	* 10/2007	Parekh D2/953	D748,902	S	* 2/2016	Humphrey D2/951	
D554,338	S	11/2007	Matis et al.	D754,956	S	5/2016	McCourt	
D556,989	S	* 12/2007	Horne D2/953	D756,085	S	5/2016	Spring	
D560,883	S	2/2008	McClaskie	D758,056	S	6/2016	Galway et al.	
D561,433	S	2/2008	McClaskie	D759,358	S	6/2016	Cullen	
D561,441	S	* 2/2008	Matis D2/953	D762,958	S	8/2016	Sars	
D564,190	S	3/2008	Belley et al.	D764,786	S	8/2016	Nascimento	
D566,938	S	* 4/2008	Matis D2/957	D765,362	S	9/2016	Kuerbis	
D566,939	S	4/2008	Schoenborn et al.	D765,961	S	9/2016	McClaskie	
D566,940	S	4/2008	Schoenborn et al.	D767,862	S	10/2016	Hurayt	
D572,447	S	7/2008	Schoenborn et al.	D773,790	S	12/2016	Raysse	
D574,581	S	8/2008	Cooper	D773,791	S	12/2016	Raysse	
D576,780	S	9/2008	Jolicoeur	D776,410	S	1/2017	Galway et al.	
D578,282	S	10/2008	Duffy	D777,412	S	1/2017	Antonelli	
D578,743	S	10/2008	Liow	D781,543	S	3/2017	Raysse	
				9,591,891	B1	3/2017	Baucom et al.	
				D782,799	S	4/2017	Caron et al.	
				9,610,746	B2	4/2017	Wardlaw et al.	
				D788,422	S	6/2017	Gibson	

(56)

References Cited

U.S. PATENT DOCUMENTS

D792,067 S 7/2017 Raysse
 D794,289 S 8/2017 Kanata
 D796,170 S 9/2017 Raysse
 D796,803 S 9/2017 Nethongkome
 D799,180 S 10/2017 Sokol
 D799,183 S 10/2017 Weeks
 D801,011 S 10/2017 Del Biondi et al.
 D802,261 S 11/2017 Stillwagon
 D802,899 S * 11/2017 Bischoff D2/957
 9,849,645 B2 12/2017 Wardlaw et al.
 D809,258 S 2/2018 McGhee
 D809,755 S 2/2018 Stavseng et al.
 D809,756 S 2/2018 Stavseng et al.
 D810,408 S 2/2018 Hernandez
 D811,062 S 2/2018 Teague
 D812,878 S 3/2018 Nethongkome
 D814,155 S 4/2018 Hernandez
 D814,758 S 4/2018 Truelsen
 9,961,961 B2 5/2018 Smith
 D819,307 S 6/2018 Wurtz
 D819,310 S 6/2018 Lashmore
 D819,317 S 6/2018 Wurtz
 D820,568 S 6/2018 Bray, Jr.
 D828,686 S 9/2018 Hoellmueller et al.
 D834,291 S 11/2018 Chang
 10,149,512 B1 12/2018 Wurtz
 D836,892 S * 1/2019 Jenkins D2/947
 D838,092 S 1/2019 Bacon
 D838,957 S 1/2019 Robusti
 D839,573 S 2/2019 Small
 D839,576 S 2/2019 Small
 D840,136 S 2/2019 Herath et al.
 D840,137 S 2/2019 Herath et al.
 D841,955 S 3/2019 Winfield
 D841,965 S 3/2019 Goldman et al.
 D842,594 S 3/2019 Small
 D846,255 S 4/2019 Khalife
 10,258,104 B2 4/2019 Kraft
 D848,715 S 5/2019 Holmes
 D848,721 S * 5/2019 Fracassi D2/958
 D849,382 S 5/2019 Jenkins et al.
 D850,083 S * 6/2019 Jenkins D2/959
 D850,766 S 6/2019 Girard et al.
 D852,475 S 7/2019 Hoellmueller
 D852,476 S 7/2019 Hartmann
 D853,099 S 7/2019 Parrett
 D853,690 S 7/2019 Taylor
 D853,691 S 7/2019 Coonrod et al.
 D853,699 S 7/2019 Coonrod et al.
 D854,288 S 7/2019 Raasch
 D855,295 S * 8/2019 Della Valle D2/908
 D855,297 S 8/2019 Motoki
 D855,953 S 8/2019 Girard et al.
 D855,959 S * 8/2019 Jenkins D2/959
 D855,960 S * 8/2019 Gibson D2/959
 D858,051 S 9/2019 Mace
 D858,059 S 9/2019 McMillan
 D858,960 S 9/2019 Mace
 D858,961 S 9/2019 Mace
 D859,797 S 9/2019 Chanthavong
 D859,801 S * 9/2019 Jenkins D2/959
 D861,311 S * 10/2019 Hatfield D2/959
 D862,051 S * 10/2019 Goussev D2/947
 D862,053 S 10/2019 de Montgolfier
 D864,539 S 10/2019 Fuerst, Sr.
 D866,137 S 11/2019 Kanata
 D866,141 S 11/2019 Seamarks
 D867,734 S 11/2019 Dieudonne
 D867,737 S * 11/2019 Kanata D2/954
 D868,440 S 12/2019 Dieudonne
 D869,833 S 12/2019 Hartmann et al.
 D870,433 S 12/2019 Hartmann et al.
 10,506,846 B2 12/2019 Wardlaw et al.
 D873,545 S 1/2020 Hartmann et al.
 D874,098 S * 2/2020 Hartmann D2/902

D874,099 S 2/2020 Hartmann et al.
 D874,107 S 2/2020 Girard et al.
 D874,801 S 2/2020 Hartmann et al.
 D875,358 S 2/2020 Vella
 D875,360 S 2/2020 Vella
 D875,361 S 2/2020 Girard et al.
 D875,362 S 2/2020 Girard et al.
 D875,383 S 2/2020 Mace
 D876,055 S 2/2020 Hartmann et al.
 D876,064 S * 2/2020 Shyllon D2/957
 D876,069 S * 2/2020 Mace D2/960
 D876,757 S * 3/2020 Hartmann D2/902
 D876,791 S 3/2020 Gridley
 D877,465 S * 3/2020 Hartmann D2/902
 D877,466 S * 3/2020 Hartmann D2/902
 D877,468 S 3/2020 Reyes
 D878,015 S 3/2020 Hartmann et al.
 D878,021 S 3/2020 Mace
 D878,025 S * 3/2020 Hartmann D2/954
 2003/0046831 A1 3/2003 Westin
 2003/0208925 A1 11/2003 Pan
 2004/0148805 A1 8/2004 Morris
 2005/0022424 A1 2/2005 Held
 2006/0026863 A1 2/2006 Liu
 2006/0175036 A1 8/2006 Guerrero
 2007/0119076 A1 5/2007 Brewer et al.
 2008/0250666 A1 10/2008 Votolato
 2009/0025260 A1 1/2009 Nakano
 2009/0100721 A1 4/2009 Gorynski
 2010/0242309 A1 9/2010 McCann
 2011/0099845 A1 5/2011 Miller
 2011/0283560 A1 11/2011 Portzline et al.
 2012/0180343 A1 7/2012 Auger et al.
 2013/0145653 A1 6/2013 Bradford
 2013/0291409 A1 11/2013 Reinhardt et al.
 2014/0151918 A1 6/2014 Hartmann
 2014/0223776 A1 8/2014 Wardlaw et al.
 2014/0373392 A1 12/2014 Cullen
 2015/0047222 A1 2/2015 Rushbrook
 2016/0007676 A1 1/2016 Leimer et al.
 2016/0037859 A1 2/2016 Smith et al.
 2016/0051009 A1 2/2016 Kormann et al.
 2016/0278481 A1 9/2016 Le et al.
 2016/0295955 A1 10/2016 Wardlaw et al.
 2017/0006958 A1 1/2017 Jeong
 2017/0224053 A1 8/2017 Truelsen et al.
 2017/0253710 A1 9/2017 Smith et al.
 2018/0077997 A1 3/2018 Hoffer et al.
 2018/0103719 A1 4/2018 Chen
 2018/0153264 A1 6/2018 Amos et al.
 2018/0154598 A1 6/2018 Kurtz et al.
 2018/0192738 A1 7/2018 Amos et al.
 2018/0199667 A1 7/2018 Wang
 2018/0206590 A1 7/2018 Amos et al.
 2018/0303197 A1 10/2018 Chen et al.
 2018/0317591 A1 11/2018 Hollinger et al.
 2018/0345576 A1 12/2018 Constantinou et al.
 2019/0297995 A1 10/2019 Loveder et al.

OTHER PUBLICATIONS

Porsche Design Hybrid Runner II Men's Running Shoes, Puma.com, [online], [site visited Mar. 24, 2020]. <URL: https://us.puma.com/en/us/pd/porsche-design-hybrid-runner-ii-mens-running-shoes/339956.html?dwvar_339956_color=02> (Year: 2020).*

Speed Orbiter Men's Running Shoes, Puma.com, [online], [site visited Mar. 24, 2020]. <URL: https://us.puma.com/en/us/pd/speed-orbiter-mens-running-shoes/192571.html?dwvar_192571_color=04> (Year: 2020).*

Hybrid Astro Men's Running Shoes, Puma.com, [online], [site visited Mar. 24, 2020]. <URL: https://us.puma.com/en/us/pd/hybrid-astro-mens-running-shoes/192799.html?dwvar_192799_color=08> (Year: 2020).*

This Puma Shoe Looks Like a Funhouse But Packs a Propulsive Punch, RunnersWorld.com, by Amanda Furrer, Aug. 19, 2019, [online], [site visited Mar. 24, 2020]. <URL: <https://www.runnersworld.com/gear/a28746944/puma-speed-orbiter-review/>> (Year: 2019).*

(56)

References Cited

OTHER PUBLICATIONS

Adidas Parleyu posted by Dan Howarth posted date Jun. 8, 2016, © Dezeen, [online], [site visited Jun. 23, 2019]. Available from Internet, <https://www.dezeen.com/2016/06/08/adidas-trainers-parley-for-the-ocean-plastic-design-recycling/> (Year: 2016).

Axelion Sneaker posted by PU MA posted date Sep. 21, 2015, © Amazon, [online], [site visited Aug. 26, 2019]. Available from Internet, <https://www.amazon.com/PUMA-Axelion-Sneaker-Black-White> (Year: 2015).

Hybrid Astro Men's Running Shoes, Puma.com, [online], [site visited Nov. 21, 2019]. <URL: https://us.puma.com/en/us/pd/hybrid-astro-mens-running-shoes/192799.html?dwvar_192799_color=06> (Year: 2019).

Hybrid NX Rave Men's Running Shoes, Puma.com, [online], [site visited Nov. 21, 2019]. <URL: https://us.puma.com/en/us/pd/hybrid-nx-rave-mens-running-shoes/192589.html?dwvar_192589_color=01> (Year: 2019).

Hybrid Rocket posted by PUMA posted date Aug. 9, 2018, © Amazon UK, [online], [site visited Jun. 23, 2019]. Available from Internet, <https://www.amazon.co.uk/Puma-Hybrid-Rocket-Competition-Running/dp> (Year: 2018).

Hybrid Runner posted by PUMA posted date Sep. 21, 2015, © Amazon, [online], [site visited Aug. 26, 2019]. Available from Internet, https://www.amazon.com/PUMA-Mens-Hybrid-Runner-Sneaker/dp/B0784VD6W7/ref=pd_sbs_309_5/137-0173175-0769536?encoding=UTF8&pd_rd_i=B0784VD6W7&pd_rd_r=be13506c-96a2-4b93-99d7-8cb69349032.

Hybrid Running Sneaker posted by PUMA posted date Aug. 9, 2018, © Amazon, [online], [site visited Aug. 1, 2019]. Available from Internet, <https://www.amazon.com/PUMA-Hybrid-Runner-Sneaker-Peacoat-Blazing> (Year: 2018).

Introducing the Puma Jamming Cushion posted by Mario Briguglio posted date Nov. 7, 2017, © Sneaker Bar Detroit, [online], [site visited Aug. 26, 2019]. Available from Internet, <https://sneakerbardetroit.com/puma-jamming-cushion-forest-night/> (Year: 2017).

Nike Flexmethod TR, Nike.com, [online], [site visited Nov. 21, 2019]. <URL: <https://www.nike.com/t/flexmethod-tr-mens-training-shoe-Shs7r6/BQ3063-005>> (Year: 2019).

Nike Force Zoom Trout 6 turf Premium, Nike.com, [online], [site visited Nov. 21, 2019]. <URL: <https://www.nike.com/t/force-zoom-trout-6-turf-premium-mens-baseball-shoe-cF8xd0/AT3881-400>> (Year: 2019).

Nike Joyride Dual Run, Nike.com, [online], [site visited Nov. 21, 2019]. <URL: <https://www.nike.com/t/joyride-dual-run-mens-running-shoe-8BGXtk/CD4365-003>> (Year 2019).

Prophere posted by Adidas posted date Aug. 2, 2012, © Amazon, [online], [site visited Aug. 12, 2019]. Available from Internet, https://www.amazon.com/dp/B07K3CFRDX/ref=nav_timeline_asin?encoding=UTF8&psc=1 (Year: 2012).

www.amazon.com/dp/B07K3CFRDX/ref=nav_timeline_asin?encoding=UTF8&psc=1 (Year: 2012).

PUMA Hybrid posted by Eli Yeh posted date Jul. 6, 2018, © YouTube, [online], [site visited Aug. 15, 2019]. Available from Internet, <https://www.youtube.com/watch?v=HdOEndfYBtO> (Year 2018).

Puma Hybrid Rocket posted by Puma posted date Sep. 21, 2015, © Amazon, [online], [site visited Aug. 26, 2019]. Available from Internet, <https://www.amazon.com/PUMA-Hybrid-Rocket-Runner-Sneaker> (Year: 2015).

Nike Air Zoom Wildhorse 5, Nike.com, [online], [site visited Nov. 21, 2019]. <URL: <https://www.nike.com/t/air-zoom-wildhorse-5-mens-trail-running-shoe-IMsIPS/AQ2222-200>> (Year: 2019).

KD Trey 5 VII, Nike.com, [online], [site visited Nov. 21, 2019]. <URL: <https://www.nike.com/t/kd-trey-5-vii-shoe-IpM0S4/AT1200-002>> (Year: 2019).

This Puma Shoe looks like a Funhouse but packs a Propulsive Punch, RunnersWorld.com, by Amanda Furrer, Aug. 19, 2019, [online], [site visited Nov. 21, 2019]. <URL: <https://www.runnersworld.com/gear/a28746944/puma-speed-orbitor-review/>> (Year: 2019).

Hybrid Fuego Men's Running Shoes, Puma.com, [online], [site visited Mar. 24, 2020]. <URL: https://us.puma.com/en/us/pd/hybrid-fuego-mens-running-shoes/192661.html?dwvar_192661_color=10> (Year: 2020), 1 page.

Ignite Flash evoKNIT Men's Training Shoes, Puma.com, [online], [site visited Mar. 24, 2020]. <URL: https://us.puma.com/en/us/pd/ignite-flash-evoknit-mens-training-shoes/190508.html?dwvar_190508_color=28> (Year: 2020), 1 page.

Persist XT Knit Men's Training Shoes, Puma.com, [online], [site visited Mar. 24, 2020]. <URL: https://us.puma.com/en/us/pd/persist-xt-knit-men%E2%80%99s-training-shoes/192616.html?dwvar192616_color=03> (Year: 2020), 1 page.

PUMA Men's Hybrid Astro Sneaker, Amazon.com, Date first listed on Amazon: May 16, 2019, [online], [site visited Mar. 24, 2020]. <URL: <https://www.amazon.com/PUMA-Mens-Hybrid-Astro-Sneaker/dp/B07TNXFVBV?th=1>> (Year: 2019), 3 pages.

PUMA Men's Hybrid Fuego Sneaker, Amazon.com, Date first listed on Amazon: May 16, 2019, [online], [site visited Mar. 24, 2020]. <URL: <https://www.amazon.com/PUMA-Mens-Hybrid-Fuego-Sneaker/dp/B07KRVL6S8?th=1>> (Year: 2019), 3 pages.

SNEAKERSER midsole painting—Nike Air max 1 'HOA' [Episode THREE], YouTube.com, Sneakers ER, Published on Aug 23, 2016, [online], [site visited Mar. 24, 2020]. <URL: https://www.youtube.com/watch?v=zGVcLdN_H9M> (Year: 2016), 1 page.

The Technologies That Define Sneaker Cushioning, Forbes.com, Nov 5, 2018, 10:47am EST, Tim Newcomb, [online], [site visited Mar. 24, 2020]. <URL: <https://www.forbes.com/sites/timnewcomb/2018/11/05/the-technologies-that-define-sneaker-cushioning/#2c2e6da3356e>> (Year: 2018), 15 pages.

* cited by examiner

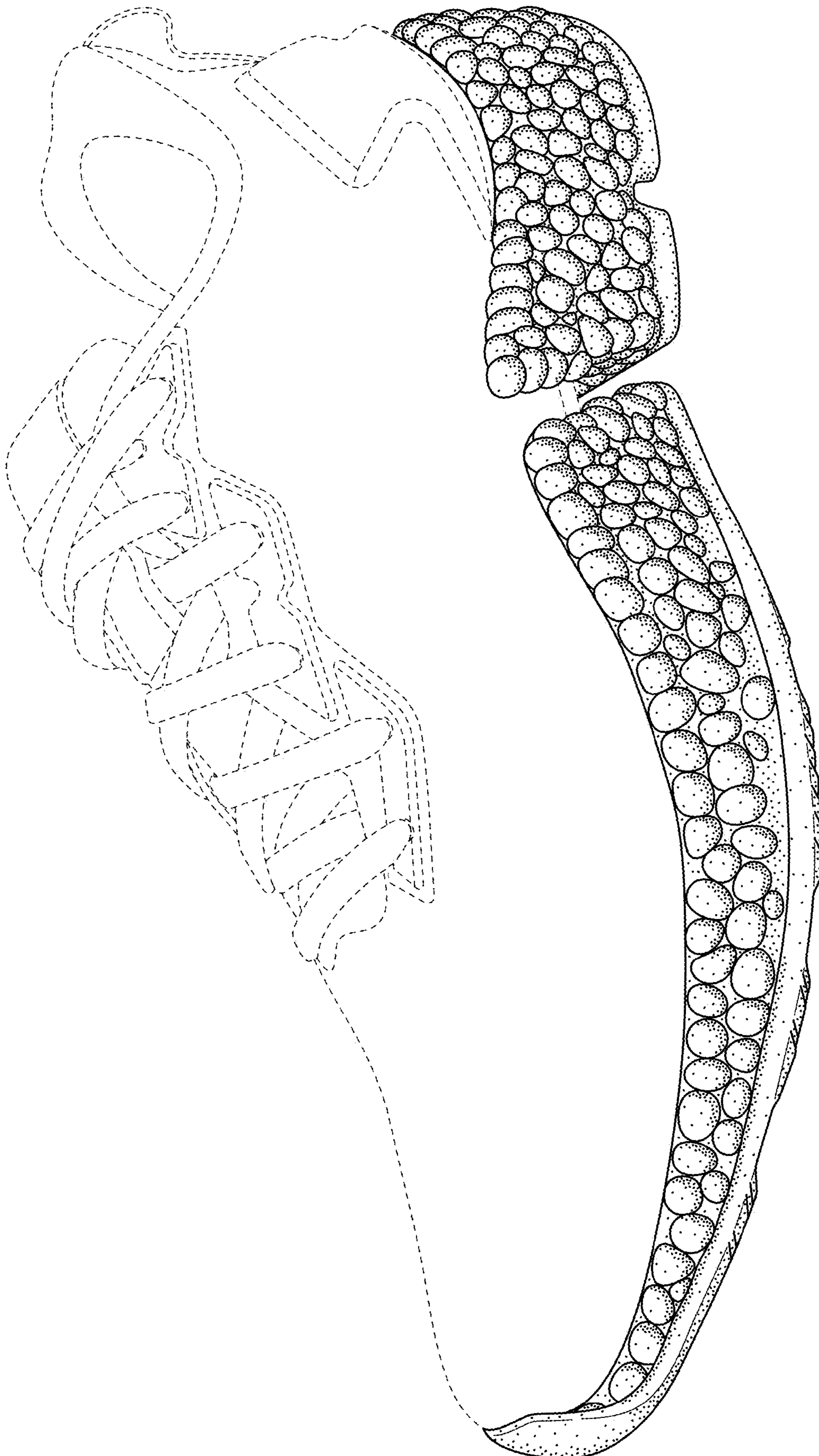

FIG. 1

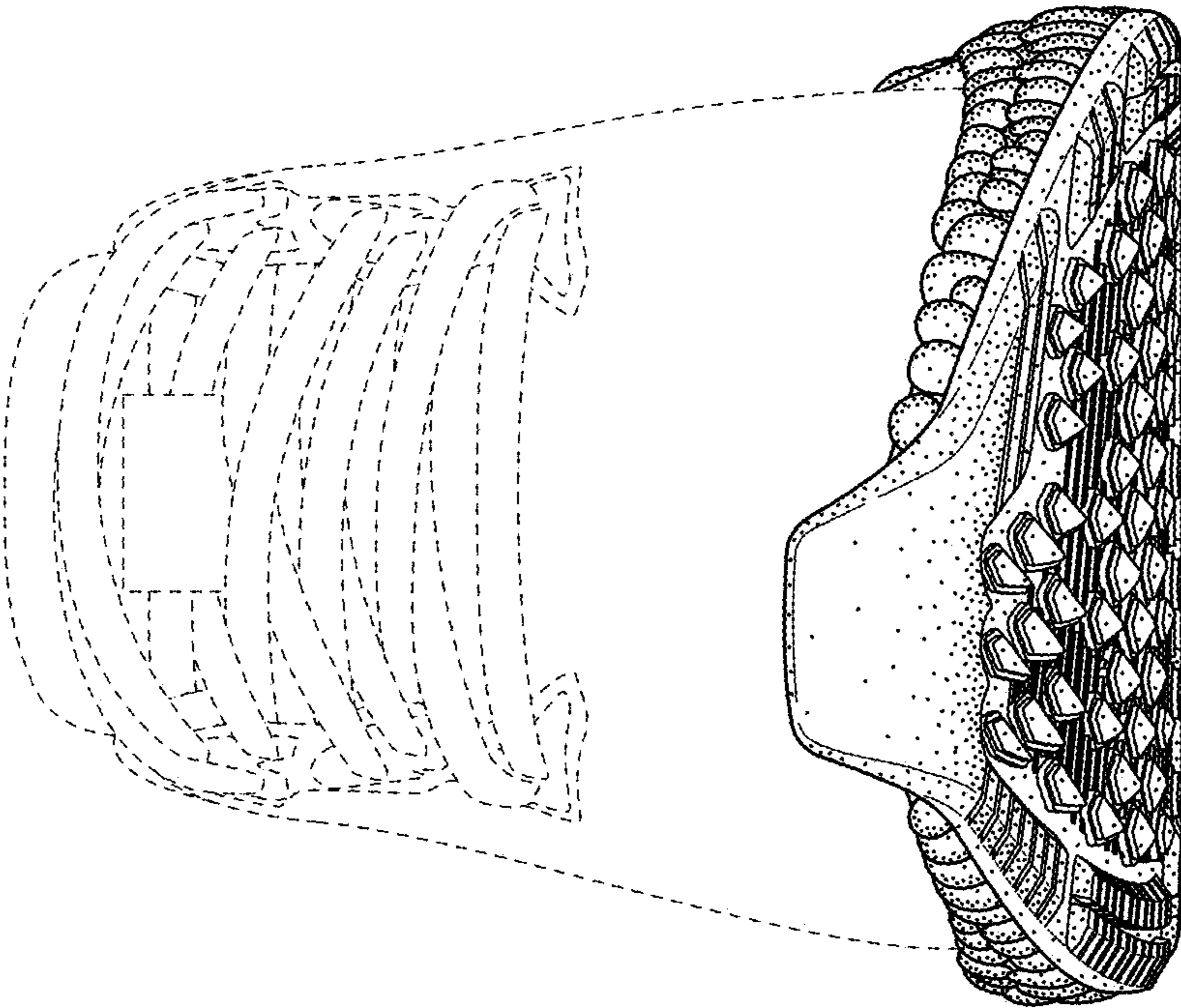

FIG. 2

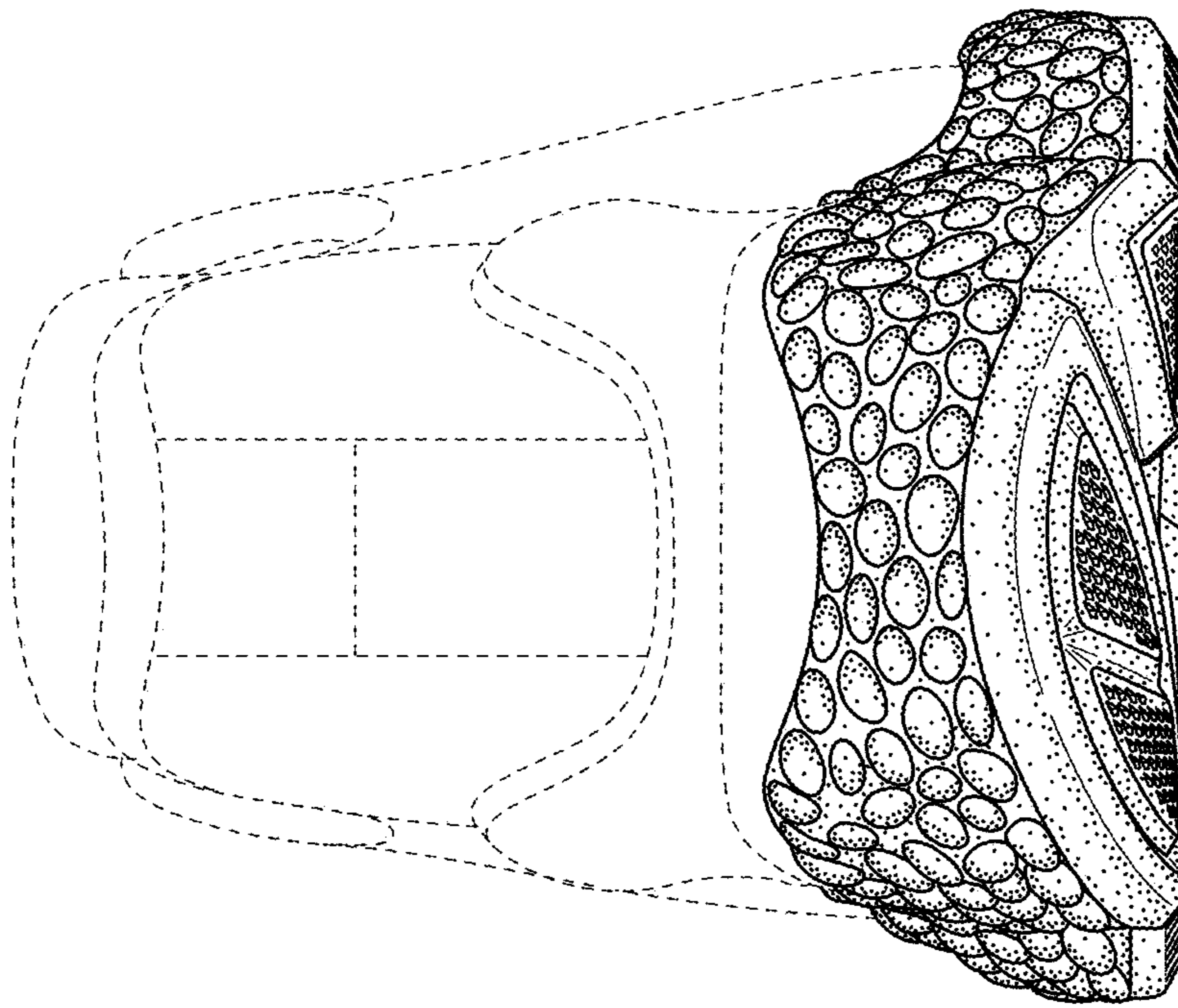

FIG. 3

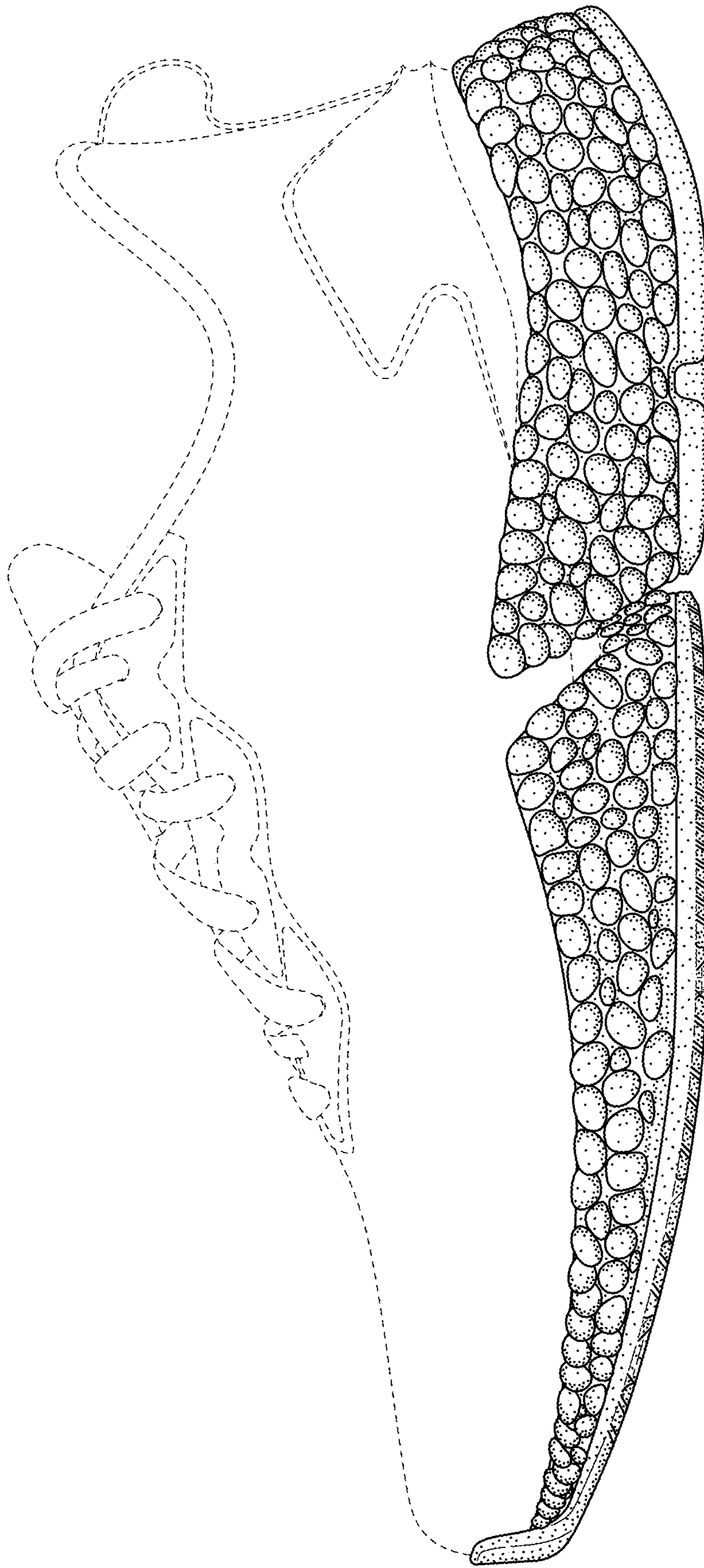

FIG. 4

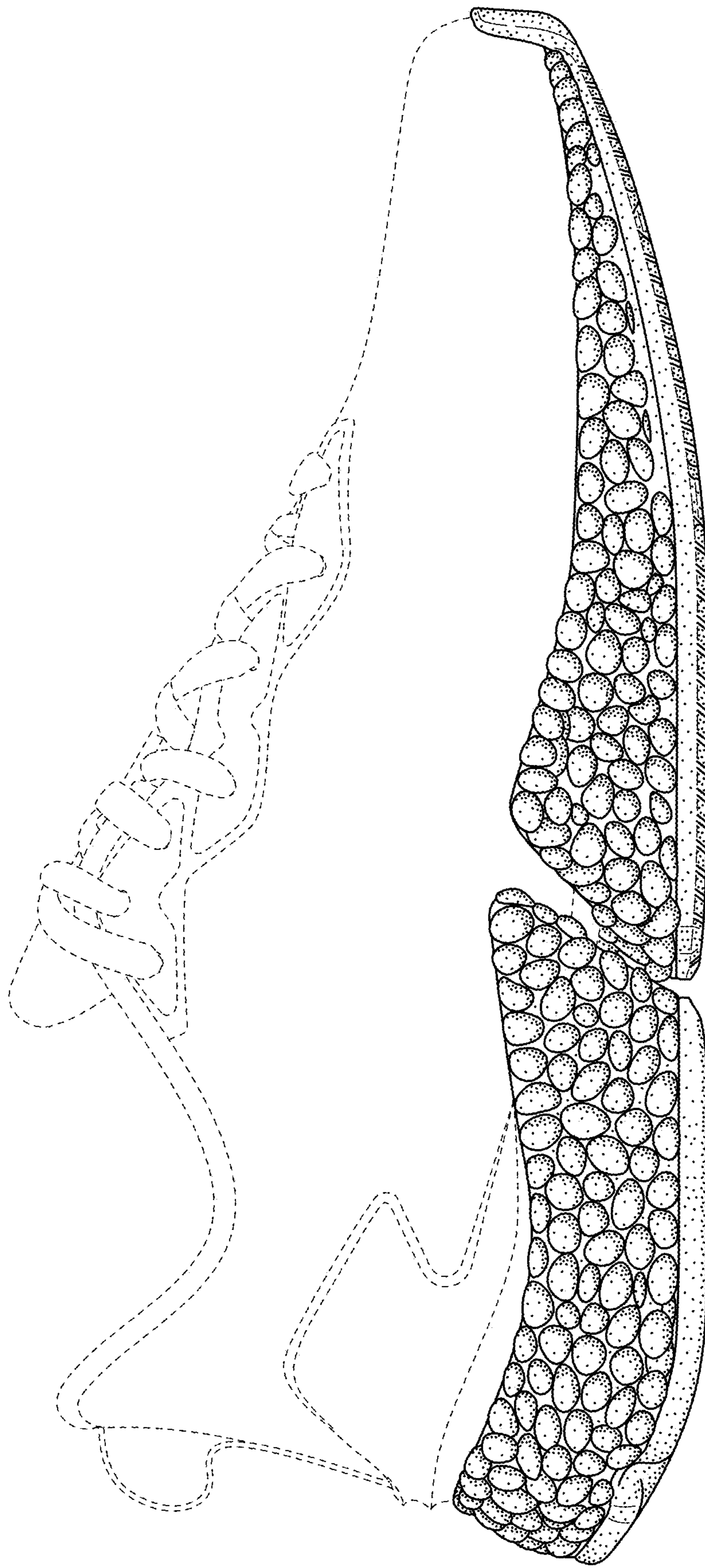

FIG. 5

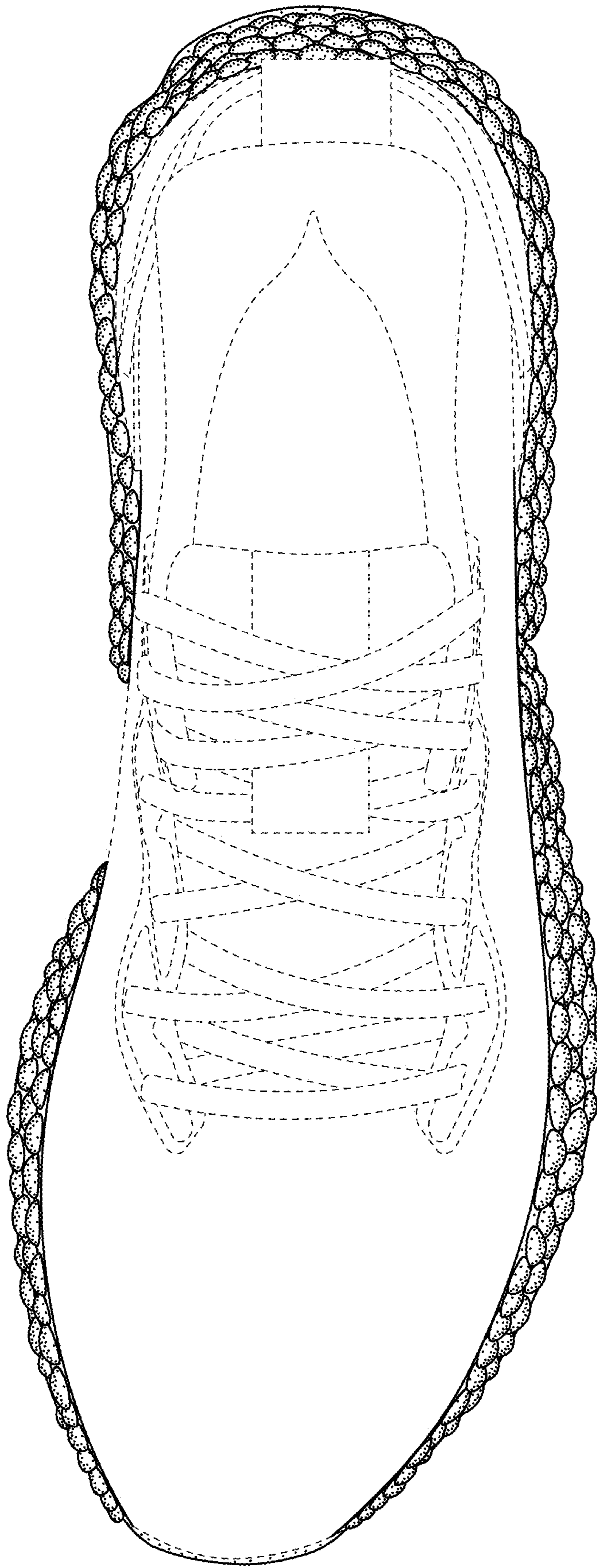

FIG. 6

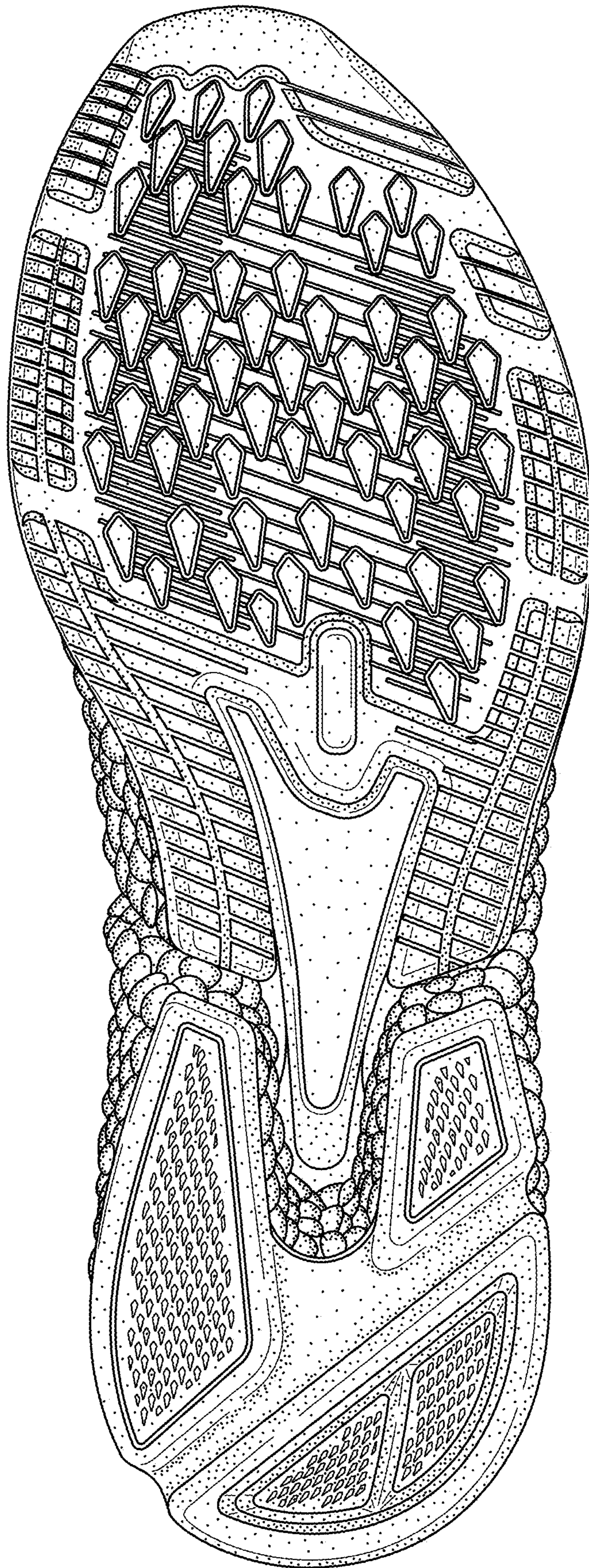

FIG. 7

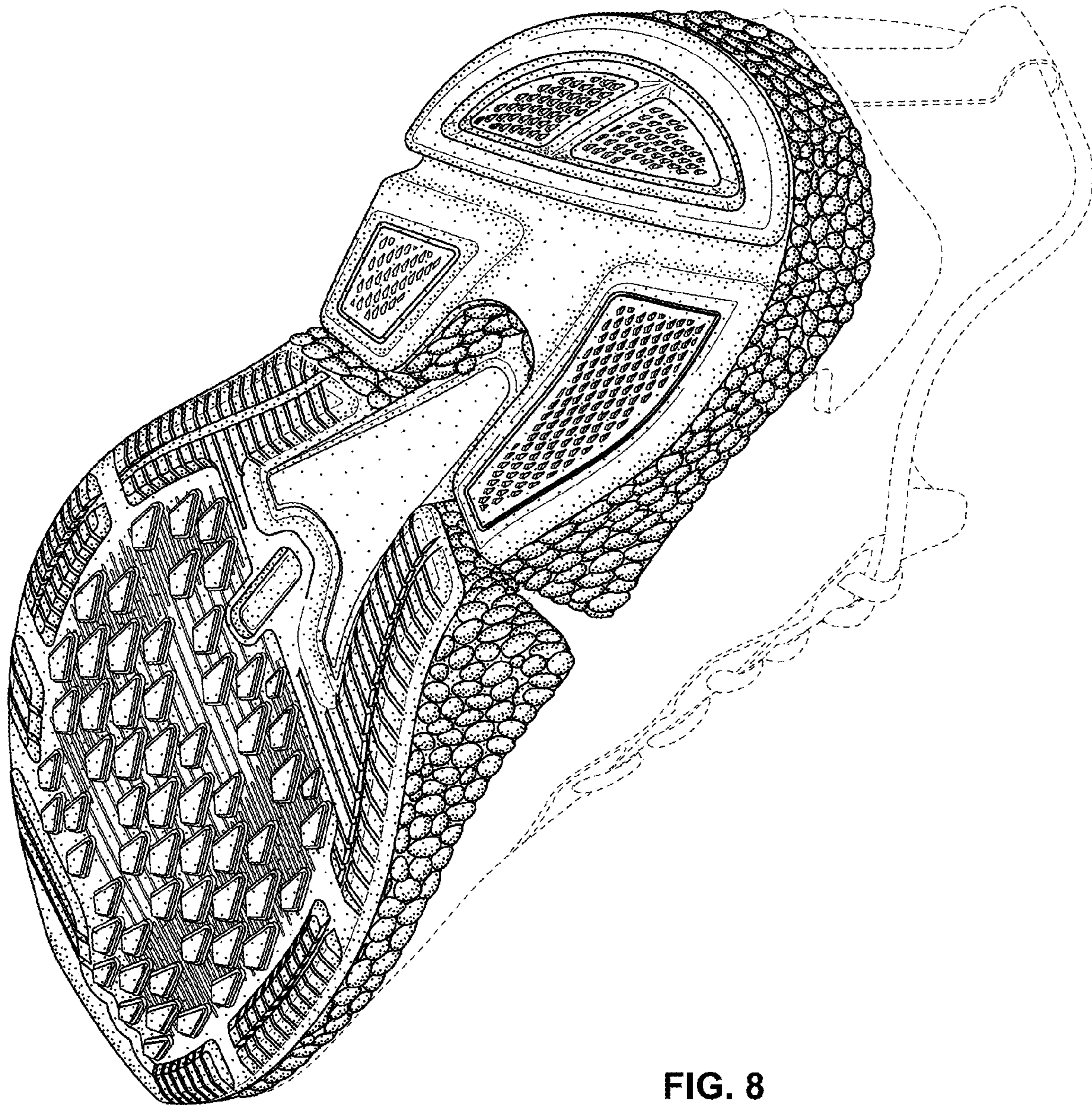

FIG. 8