



US00D890419S

(12) **United States Design Patent** (10) **Patent No.:** **US D890,419 S**  
**Tasselli** (45) **Date of Patent:** **\*\* Jul. 14, 2020**

(54) **NICOTINE INHALER**  
(71) Applicant: **McNeil AB**, Helsingborg (SE)  
(72) Inventor: **Corrado Tasselli**, Malmö (SE)  
(73) Assignee: **McNeil AB**, Helsingborg (SE)  
(\*\*) Term: **15 Years**  
(21) Appl. No.: **29/663,957**

D788,697 S \* 6/2017 Verleur ..... D13/103  
D799,111 S \* 10/2017 Qiu ..... D27/101  
D799,743 S \* 10/2017 Qiu ..... D27/101  
D799,744 S 10/2017 Qiu  
D799,746 S \* 10/2017 Leidel ..... D27/163  
D800,380 S \* 10/2017 Williams ..... D27/163  
D802,206 S \* 11/2017 Huang ..... D27/101  
D828,621 S \* 9/2018 Qiu ..... D27/162  
D833,063 S \* 11/2018 Qiu ..... D27/101  
D843,052 S \* 3/2019 Powell ..... D27/163  
D846,492 S \* 4/2019 Verleur ..... D13/103  
D851,827 S \* 6/2019 Clark ..... D27/162  
D853,634 S \* 7/2019 Qiu ..... D27/162

(22) Filed: **Sep. 20, 2018**

**FOREIGN PATENT DOCUMENTS**

(30) **Foreign Application Priority Data**

TW D159216 S 3/2014  
TW D160371 S 5/2014

Mar. 23, 2018 (EM) ..... 005013505-0003  
Mar. 23, 2018 (EM) ..... 005013505-0004

\* cited by examiner

(51) **LOC (12) Cl.** ..... **27-02**

*Primary Examiner* — Marissa J Cash  
*Assistant Examiner* — Rebecca Tsehaye

(52) **U.S. Cl.**  
USPC ..... **D27/163**

(57) **CLAIM**

(58) **Field of Classification Search**

I claim the ornamental design for a nicotine inhaler, as shown and described.

USPC ..... D27/162–165, 172, 174, 175, 176, 183,  
D27/185–194; D24/110, 100.5;  
128/202.21, 203.12, 203.15; 131/273,  
131/270, 191, 328, 329, 330, 360–365  
CPC .... A24F 47/002; A24F 47/006; A24F 47/008;  
A61M 15/00; A61M 15/06  
See application file for complete search history.

**DESCRIPTION**

(56) **References Cited**

**U.S. PATENT DOCUMENTS**

D299,066 S \* 12/1988 Newell ..... D24/110  
D759,303 S \* 6/2016 Afridi ..... D27/101  
D763,502 S \* 8/2016 Verleur ..... D27/167  
D776,869 S \* 1/2017 Heidl ..... D27/163  
D786,497 S \* 5/2017 Sudlow ..... D27/162  
D788,364 S \* 5/2017 Chen ..... D27/163

FIG. 1 is a top perspective view of my new design for a nicotine inhaler;  
FIG. 2 is a top view thereof;  
FIG. 3 is a right side view thereof;  
FIG. 4 is a bottom view thereof;  
FIG. 5 is a left side view thereof;  
FIG. 6 is a front view thereof; and,  
FIG. 7 is a rear view thereof.  
The broken lines in the drawings depict portions of the nicotine inhaler that form no part of the claimed design.

**1 Claim, 4 Drawing Sheets**

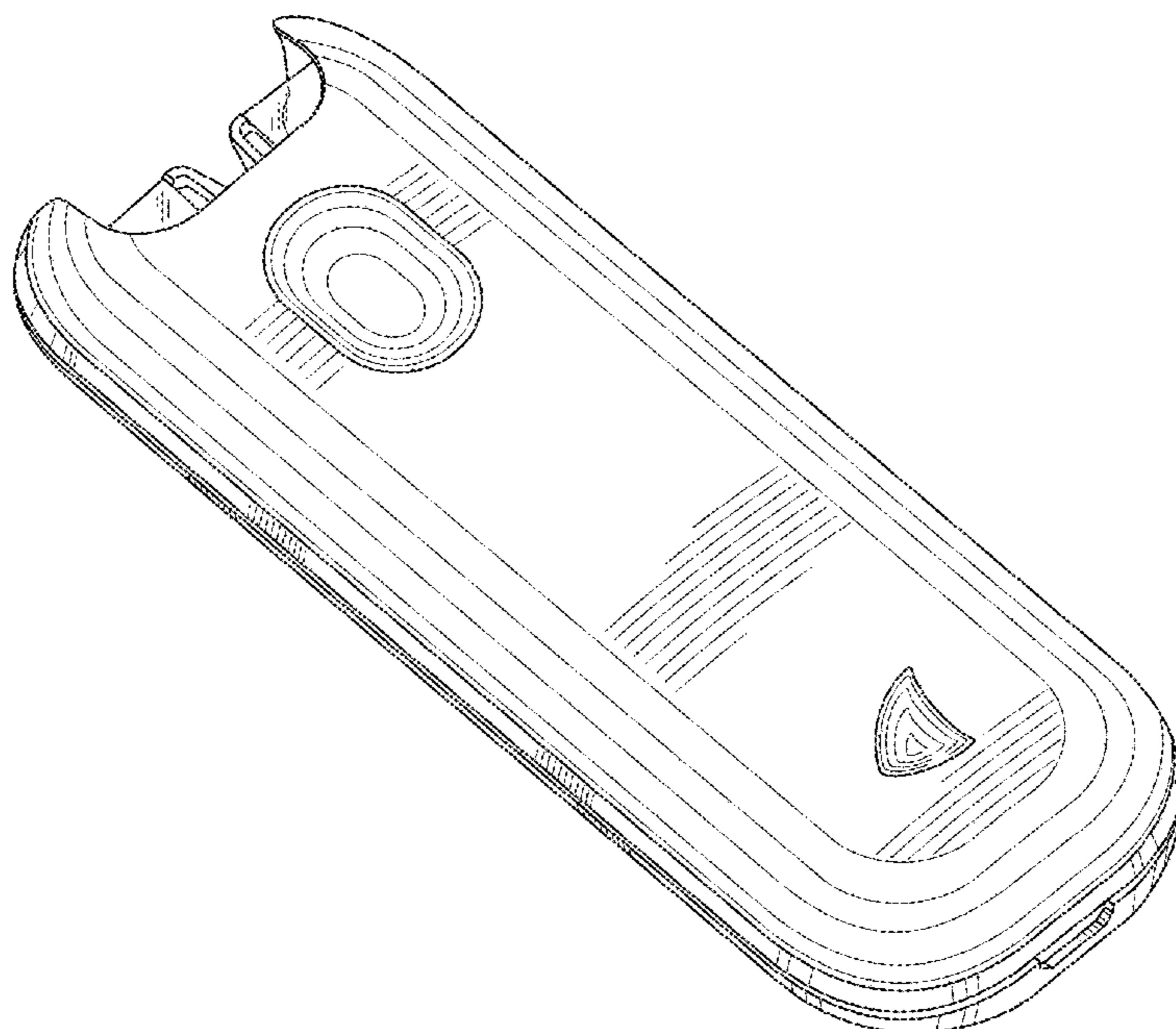

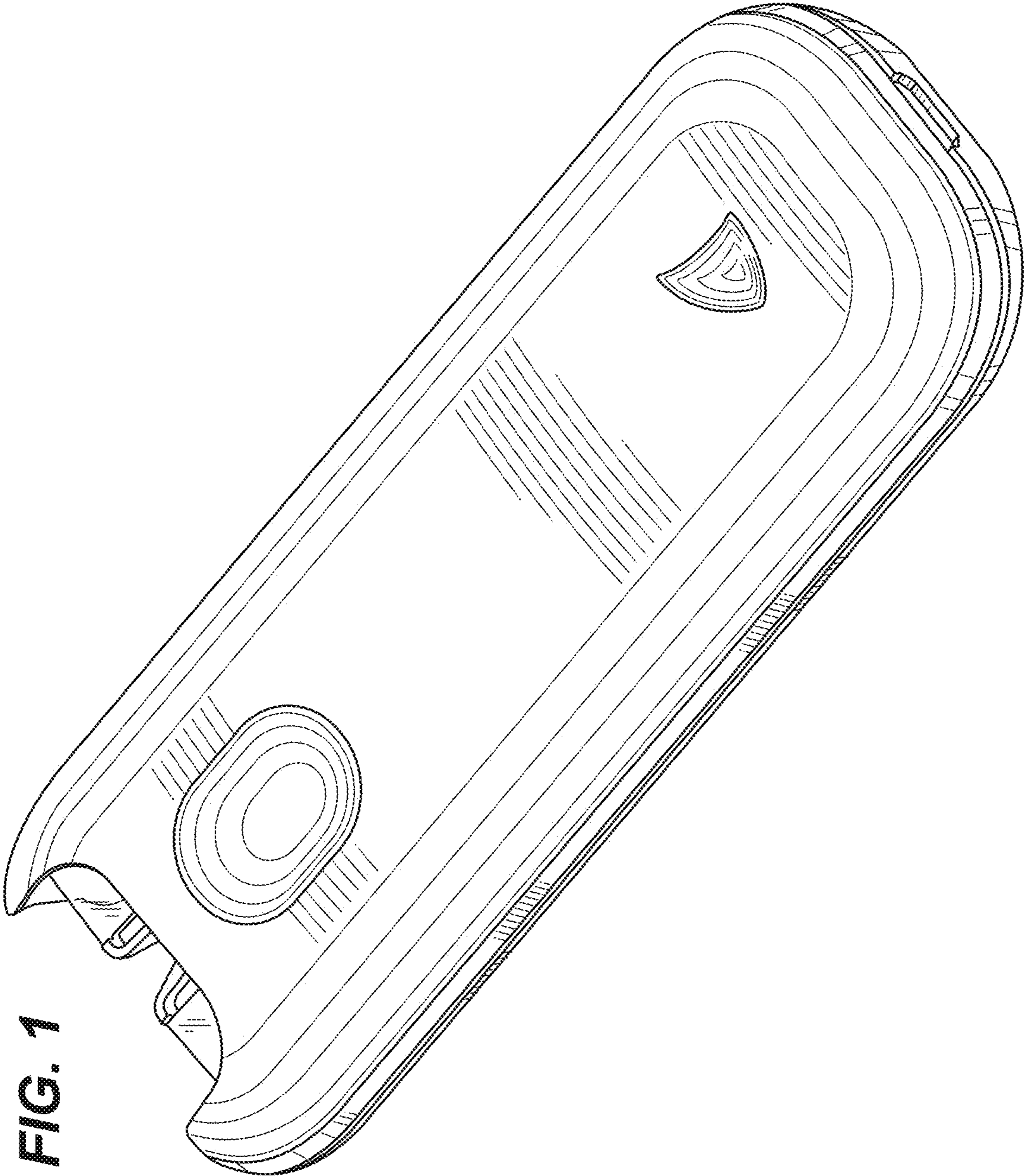
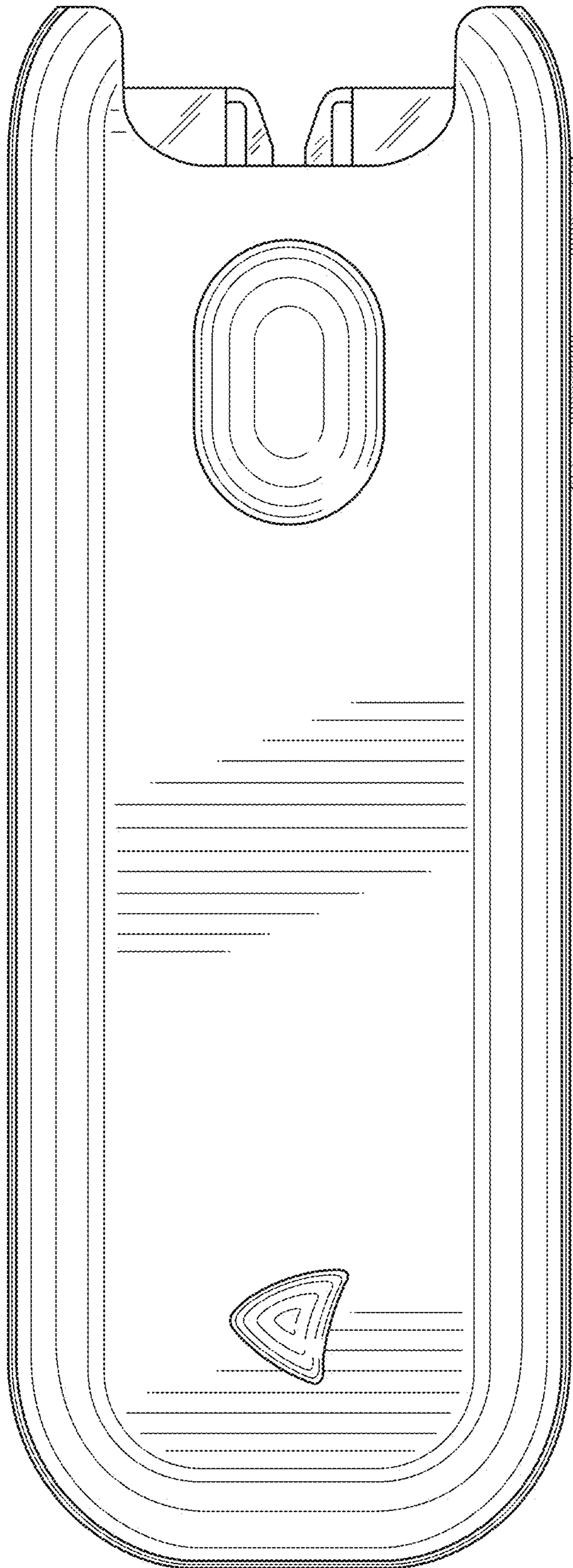
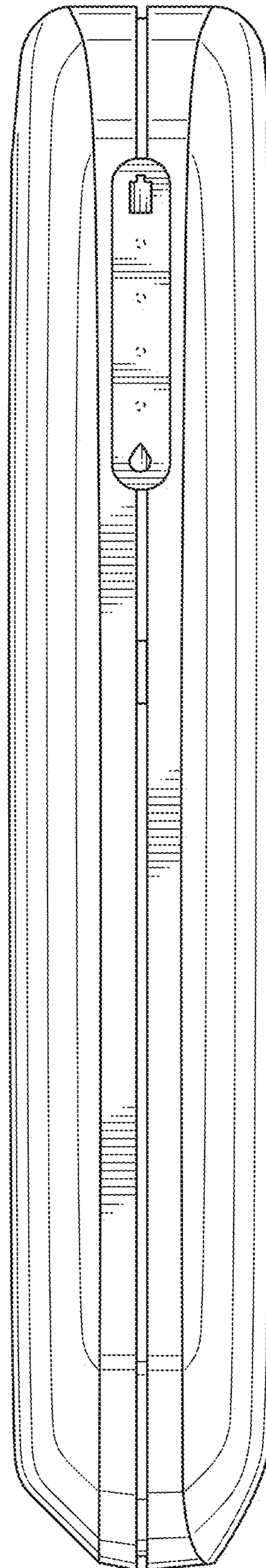

FIG. 1

**FIG. 2**



**FIG. 3**



**FIG. 4**

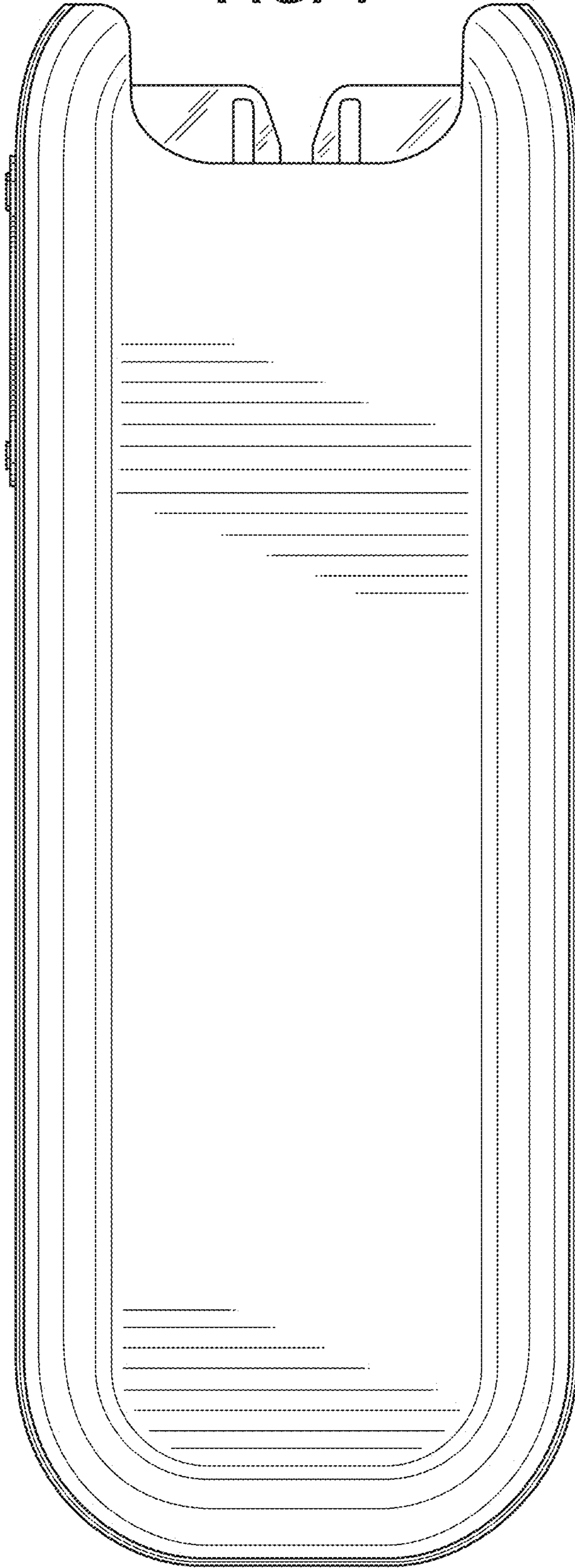

**FIG. 5**

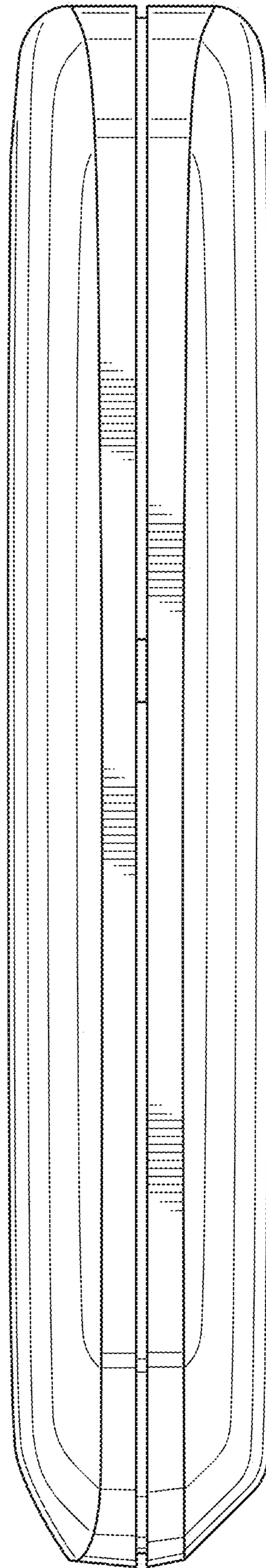

**FIG. 6**

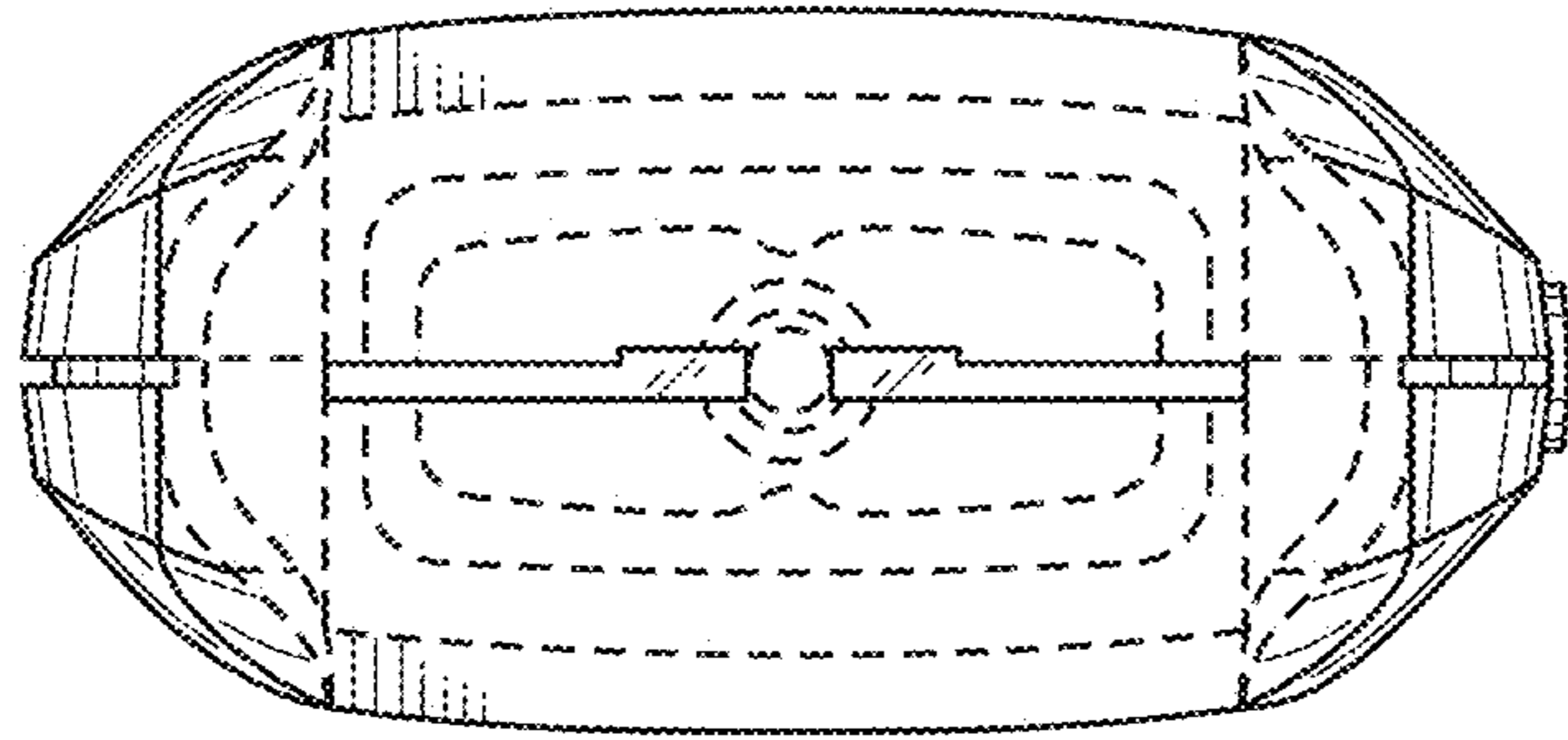

**FIG. 7**

