

US00D890390S

(12) **United States Design Patent**
Lee et al.

(10) **Patent No.:** **US D890,390 S**
(45) **Date of Patent:** **** Jul. 14, 2020**

(54) **REAR COMBINATION LAMP FOR VEHICLES**

(71) Applicants: **HYUNDAI MOTOR COMPANY**,
Seoul (KR); **KIA MOTORS CORPORATION**, Seoul (KR)

(72) Inventors: **Soon-II Lee**, Hwasung-shi (KR);
Hyun-Soo Han, Seongnam-shi (KR)

(**) Term: **15 Years**

(21) Appl. No.: **35/507,017**

(22) Filed: **Nov. 21, 2018**

(80) **Hague Agreement Data**

Int. Filing Date: **Nov. 21, 2018**

Int. Reg. No.: **DM/201699**

Int. Reg. Date: **Nov. 21, 2018**

Int. Reg. Pub. Date: **Jul. 5, 2019**

(51) **LOC (12) Cl.** **26-06**

(52) **U.S. Cl.**
USPC **D26/28**

(58) **Field of Classification Search**
USPC D26/28
CPC F21S 48/00; F21S 48/10; F21S 48/115;
F21S 48/225; F21S 48/1233; F21S 48/1266; F21S 48/1388; F21S 48/2266;
F21V 21/04; B60Q 1/30; B60Q 1/2607;
B60Q 1/2696; B62J 6/00; B62J 6/04
See application file for complete search history.

(56) **References Cited**

U.S. PATENT DOCUMENTS

D635,699 S * 4/2011 Shin D26/28
D700,380 S * 2/2014 Kong D26/28

D705,967 S * 5/2014 Park D26/28
D736,431 S * 8/2015 Park D26/28
D755,419 S * 5/2016 Ko D26/28
D763,488 S * 8/2016 Kwon D26/28
D822,244 S * 7/2018 Lee D26/28
D834,227 S * 11/2018 Lee D26/28
D858,826 S * 9/2019 Han D26/28
D869,020 S * 12/2019 Allmendinger D26/28
D873,456 S * 1/2020 Han D26/28

* cited by examiner

Primary Examiner — Natasha Vujcic

(57) **CLAIM**

The ornamental design for a rear combination lamp for vehicles, as shown and described.

DESCRIPTION

1. Rear combination lamp for vehicles

1.1 : Perspective

1.2 : Front

1.3 : Back

1.4 : Left

1.5 : Right

1.6 : Top

1.7 : Bottom

Reproduction 1.1 is a perspective view of a rear combination lamp for vehicles showing our new design; reproduction 1.2 is a front view thereof; reproduction 1.3 is a back view thereof; reproduction 1.4 is a left view thereof; reproduction 1.5 is a right view thereof; reproduction 1.6 is a top view thereof; and reproduction 1.7 is a bottom view thereof.

1 Claim, 7 Drawing Sheets

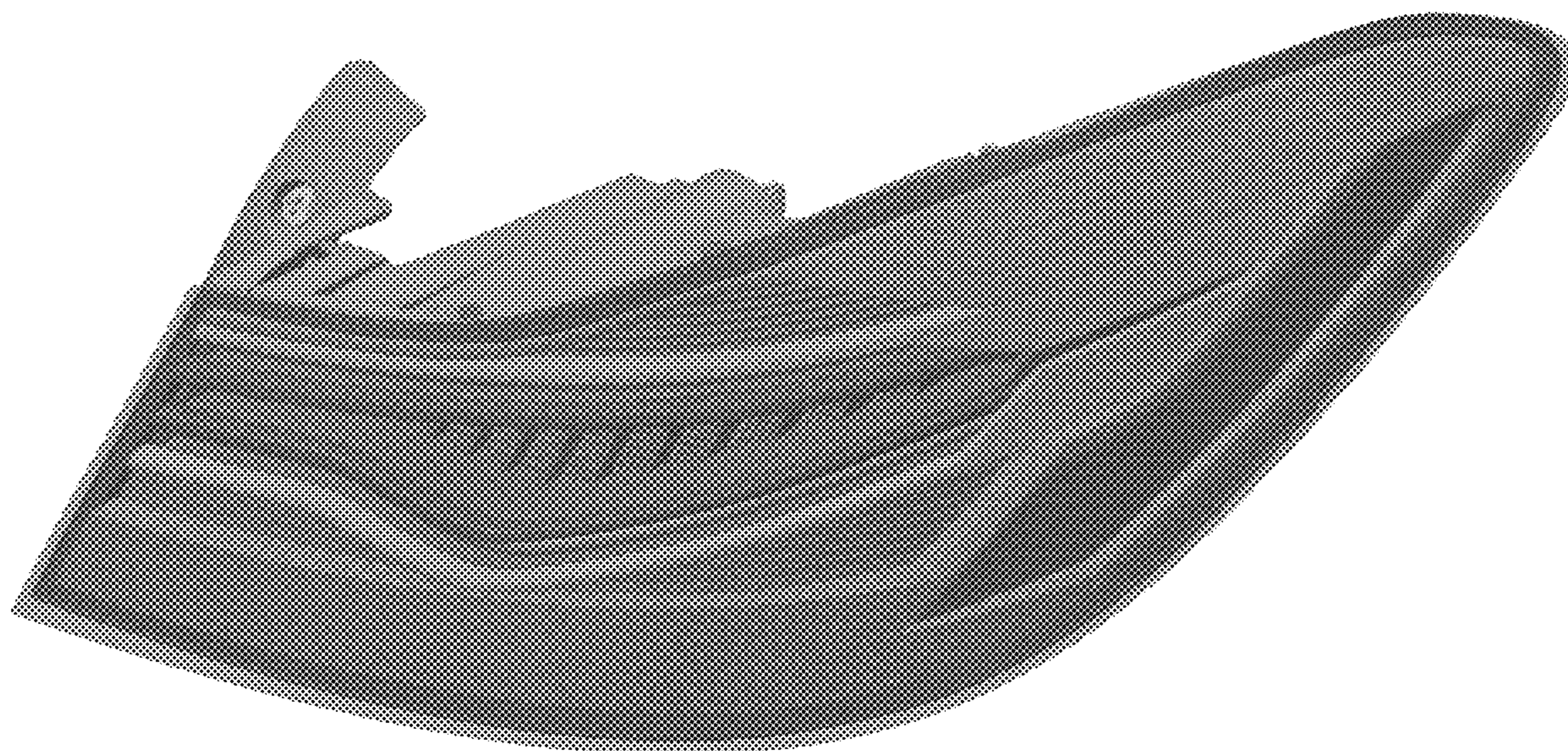

1.1

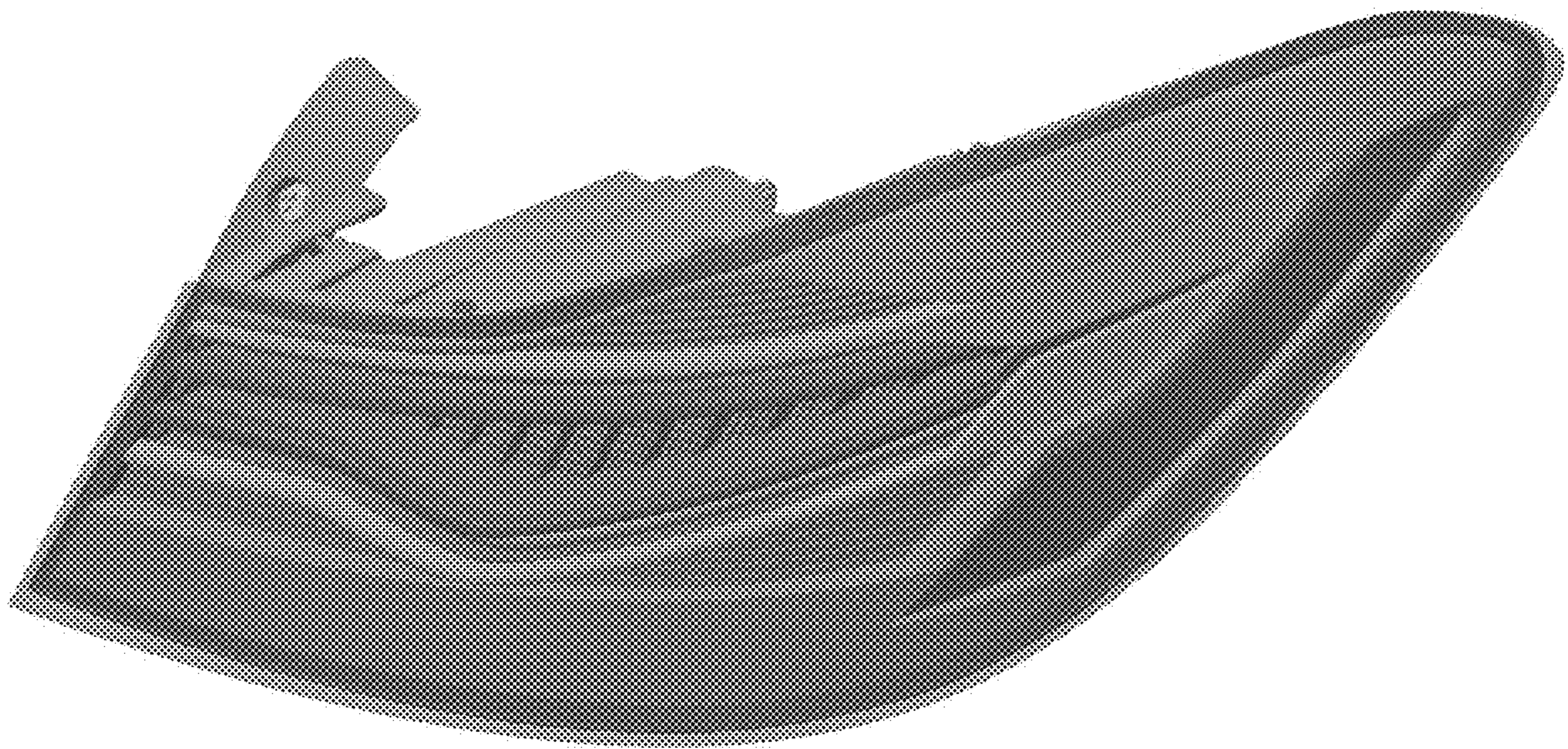

1.2

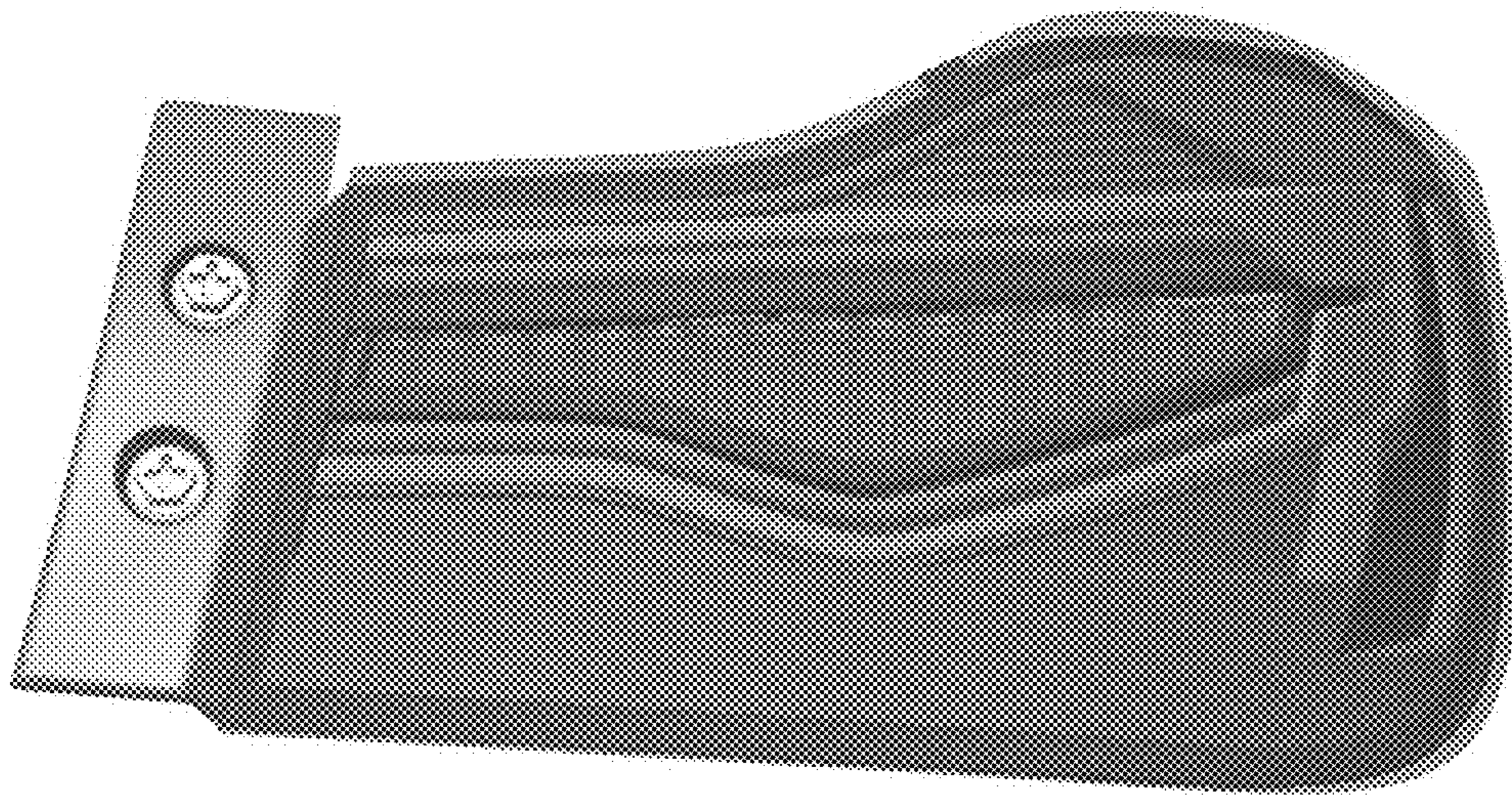

1.3

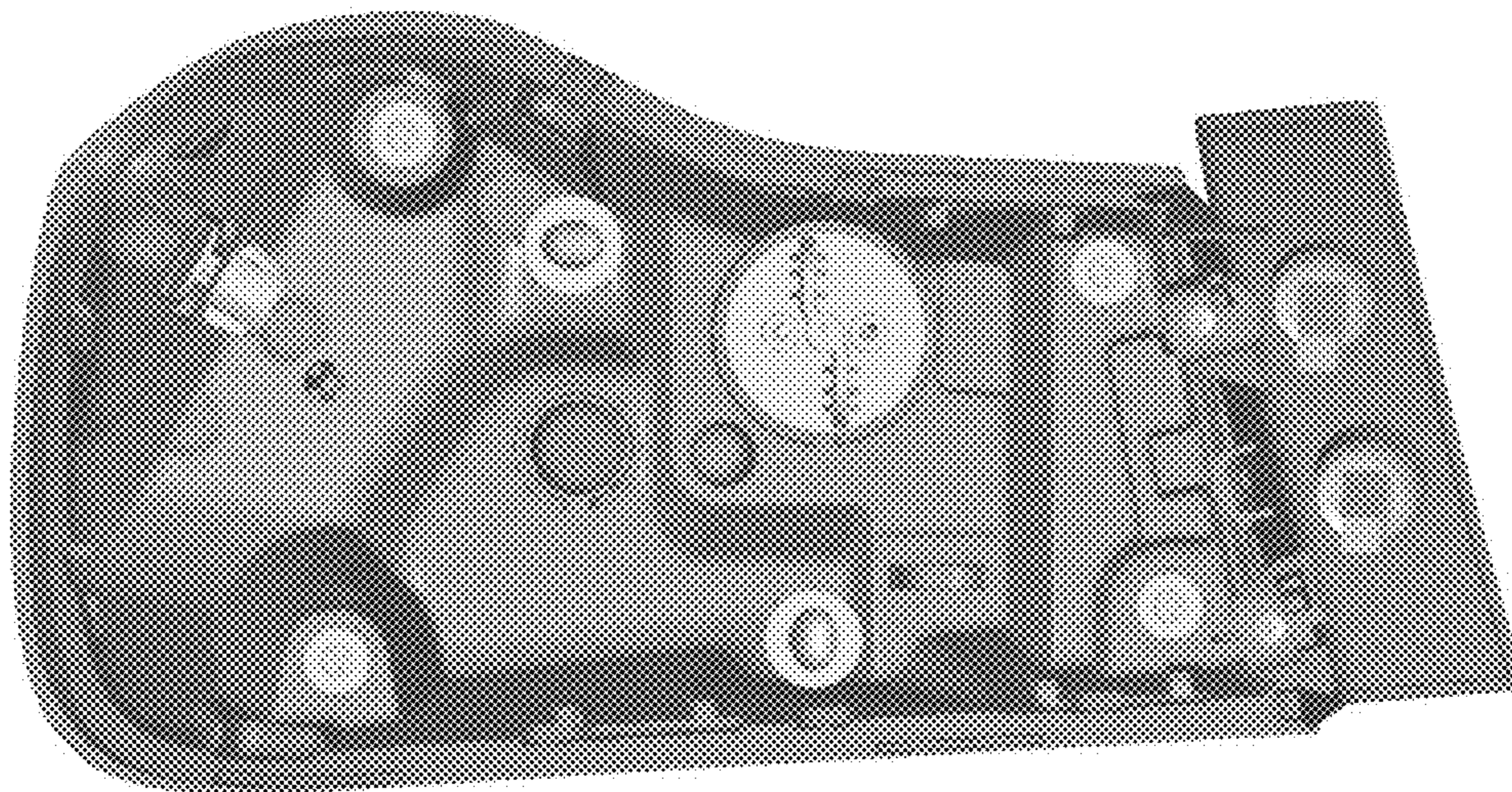

1.4

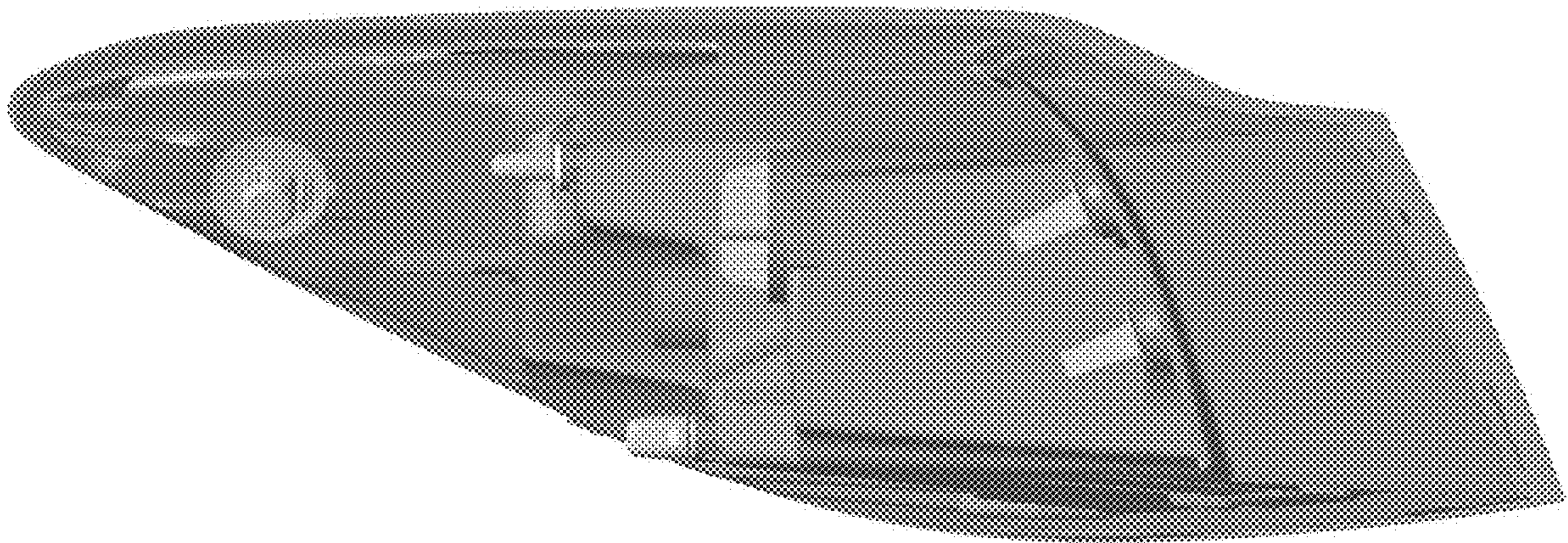

1.5

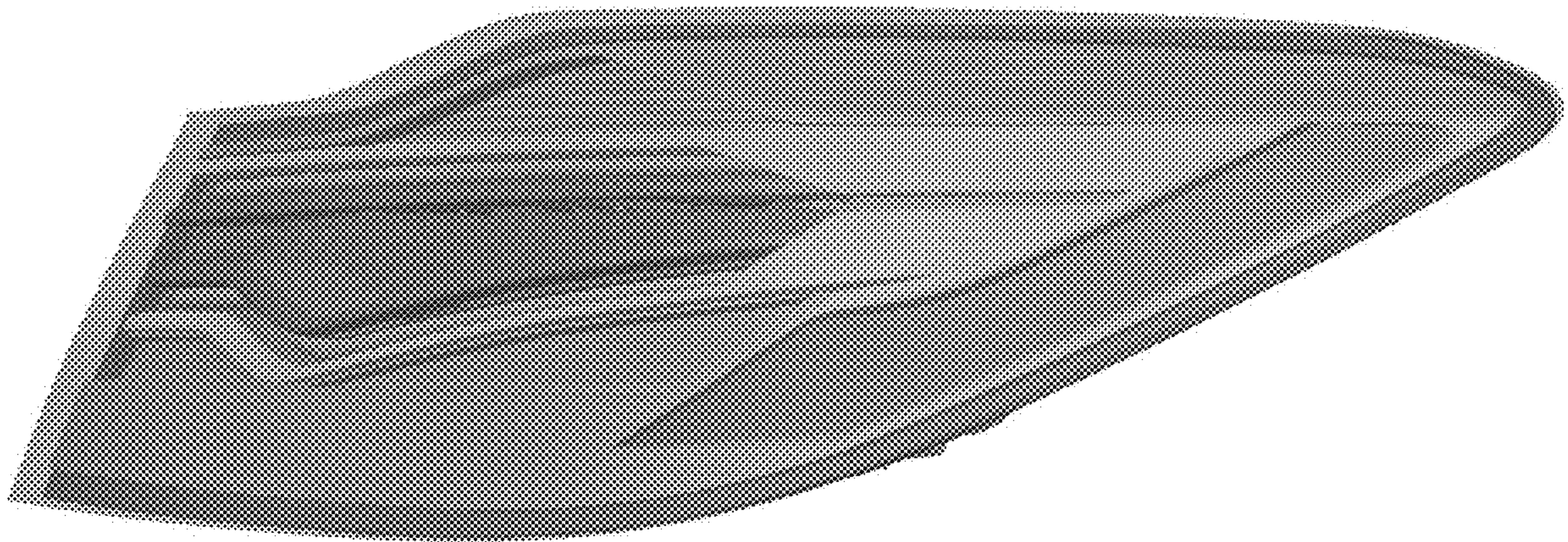

1.6

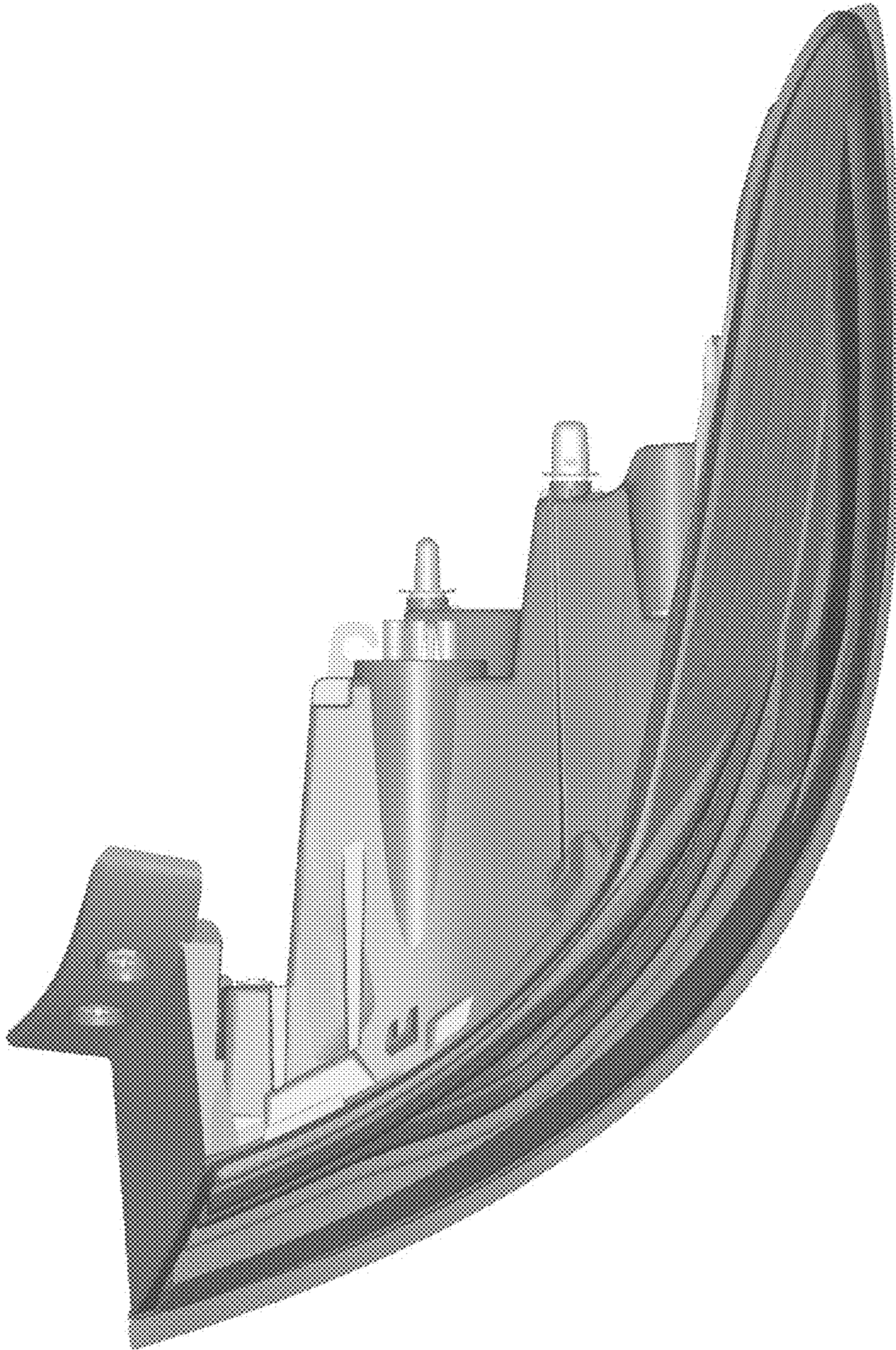

1.7

