



US00D890386S

(12) **United States Design Patent**
Wu

(10) **Patent No.:** **US D890,386 S**

(45) **Date of Patent:** **** Jul. 14, 2020**

- (54) **VEHICLE LIGHT**
- (71) Applicant: **COPLUS INC.**, Tainan (TW)
- (72) Inventor: **Po-Hua Wu**, Tainan (TW)
- (73) Assignee: **Coplus Inc.**, Tainan (TW)
- (**) Term: **15 Years**
- (21) Appl. No.: **29/694,811**

D846,770 S *	4/2019	Kozub	D26/28
D849,285 S *	5/2019	Lin	D26/28
D855,849 S *	8/2019	Lin	D26/28
D857,262 S *	8/2019	Lin	D26/28
D863,627 S *	10/2019	Lin	D26/28
D863,628 S *	10/2019	Lin	D26/28
D869,022 S *	12/2019	Wu	D26/28
D869,700 S *	12/2019	Lin	D26/28
D870,935 S *	12/2019	Wu	D26/28
D874,696 S *	2/2020	He	D26/28
D878,646 S *	3/2020	He	D26/28

- (22) Filed: **Jun. 13, 2019**
- (30) **Foreign Application Priority Data**

Jan. 4, 2019 (TW) 108300091

- (51) **LOC (12) Cl.** **26-06**
- (52) **U.S. Cl.**

USPC **D26/28**

- (58) **Field of Classification Search**
- USPC D26/28, 29, 30, 31, 32, 33, 34, 35, 36
- CPC F21S 48/00; F21S 48/10; F21S 48/115;
F21S 48/225; F21S 48/1233; F21S
48/1266; F21S 48/1388; F21S 48/2268;
F21V 21/04; F21W 2103/35; F21W 3/40;
F21W 2102/17; F21W 2102/30; F21W
2103/00; F21W 2103/55; F21W 2104/00;
F21W 2107/17; F21W 2107/13
- See application file for complete search history.

- (56) **References Cited**

U.S. PATENT DOCUMENTS

D771,291 S *	11/2016	Tsai	D26/28
D807,547 S *	1/2018	Lin	D26/28

* cited by examiner

Primary Examiner — Angela J Lee

(74) *Attorney, Agent, or Firm* — Lewis Roca Rothgerber
Christie LLP

(57) **CLAIM**

The ornamental design for vehicle light, as shown and described.

DESCRIPTION

FIG. 1 is a perspective view of a vehicle light;
 FIG. 2 is a front view thereof;
 FIG. 3 is a back view thereof;
 FIG. 4 is a left side view thereof;
 FIG. 5 is a right side view thereof;
 FIG. 6 is a top view thereof; and,
 FIG. 7 is a bottom view thereof.

The broken lines in the drawings are for illustrative purpose only and form no part of the claimed design.

1 Claim, 7 Drawing Sheets

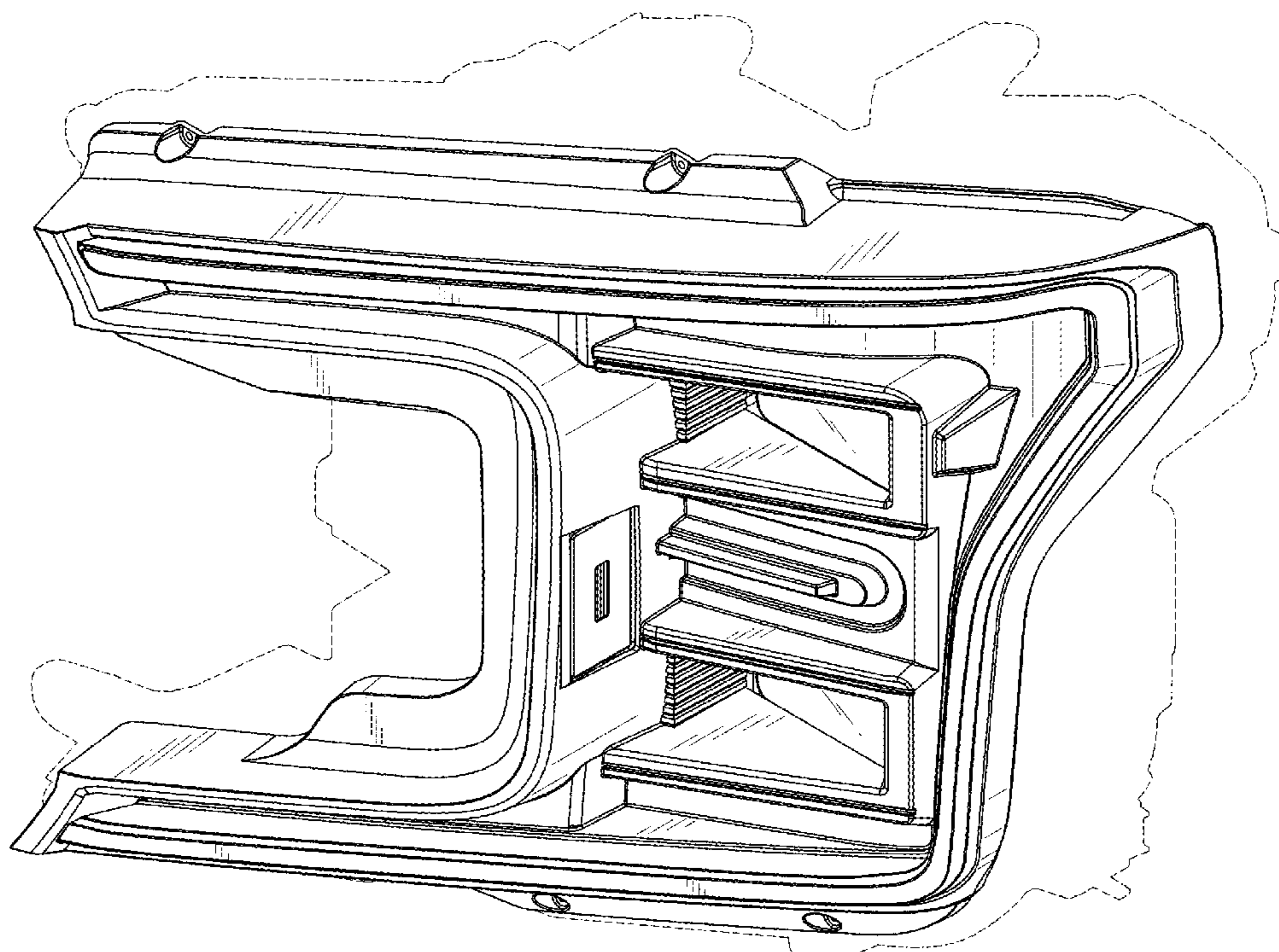

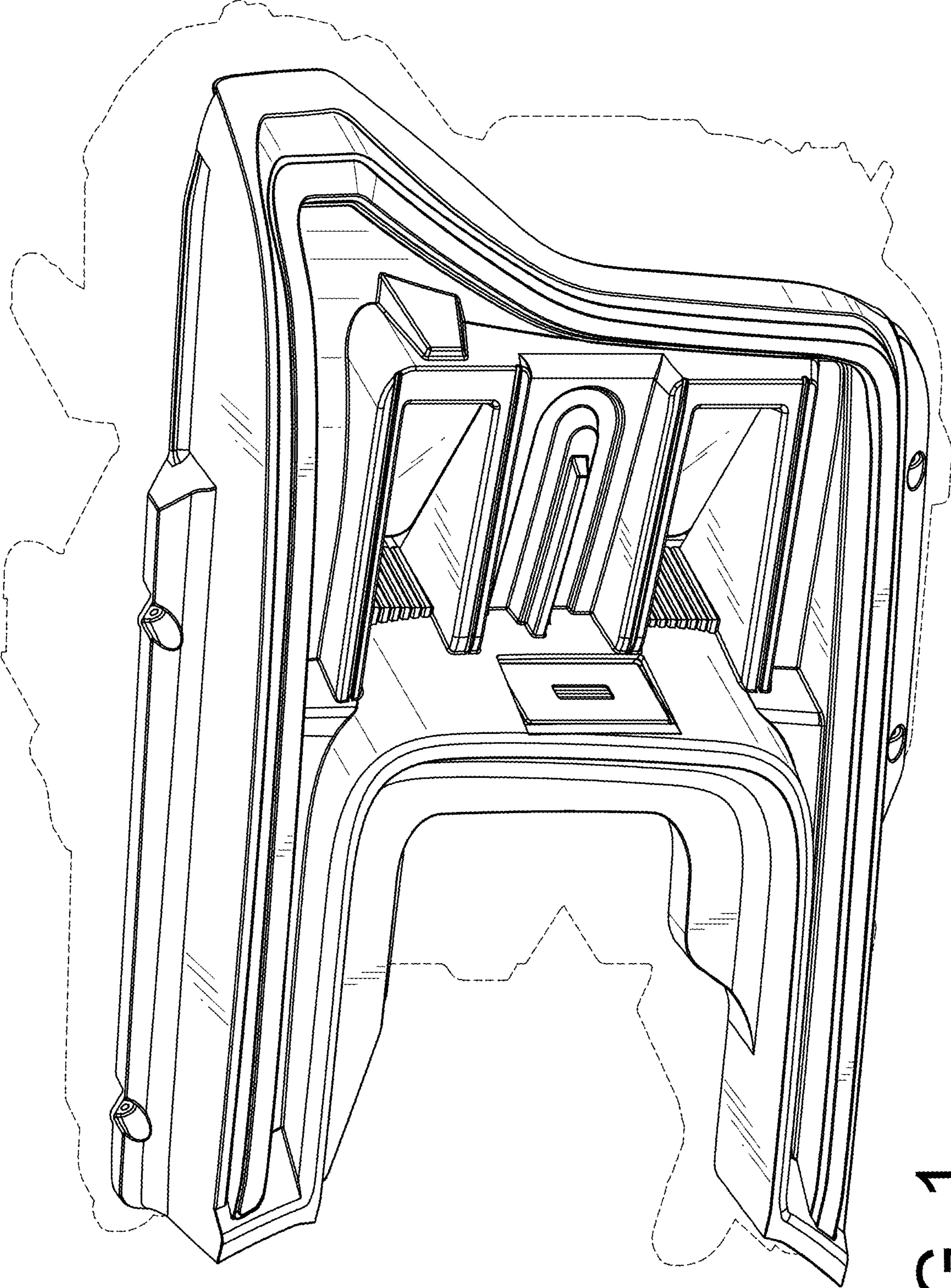

FIG. 1

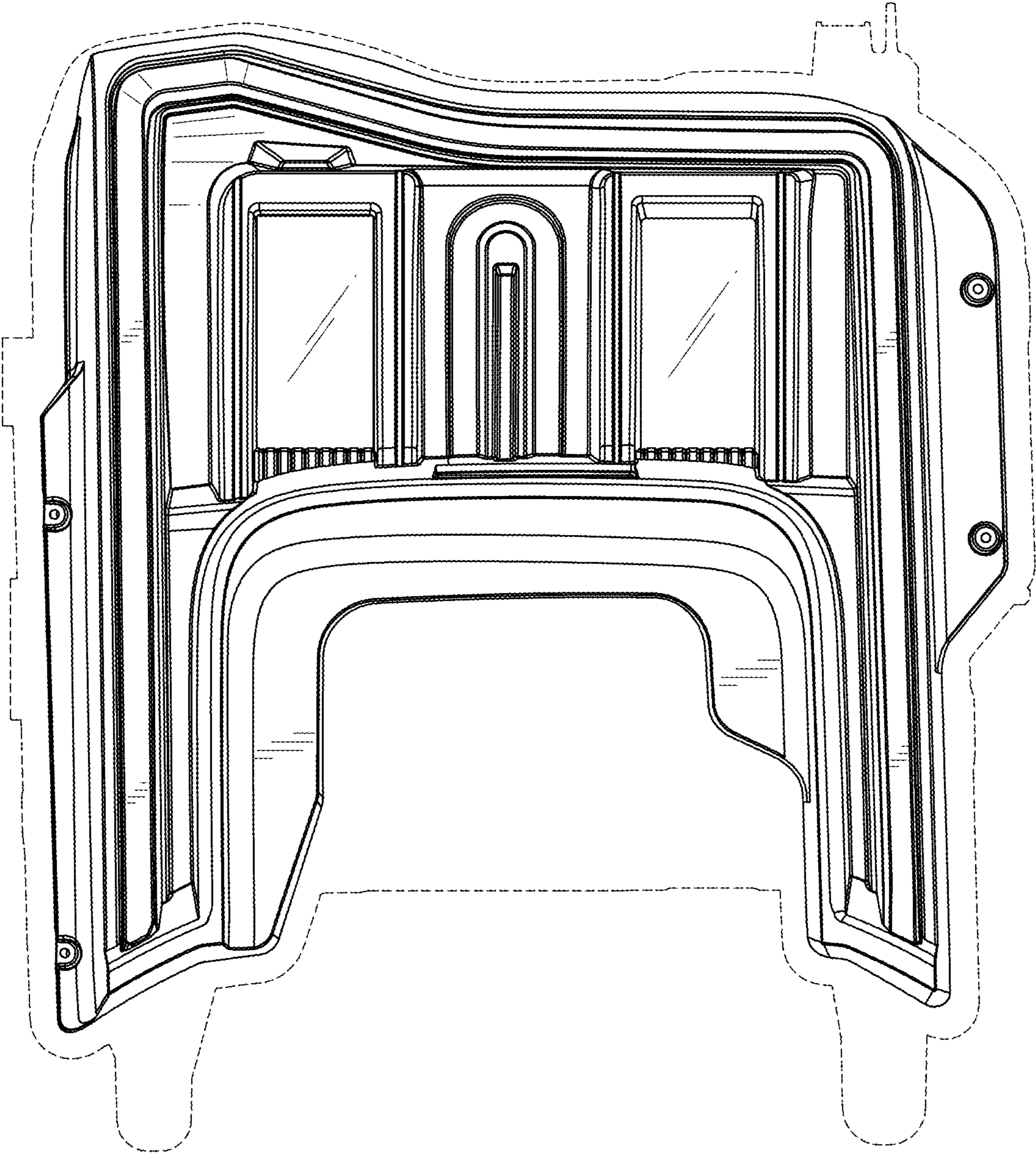

FIG. 2

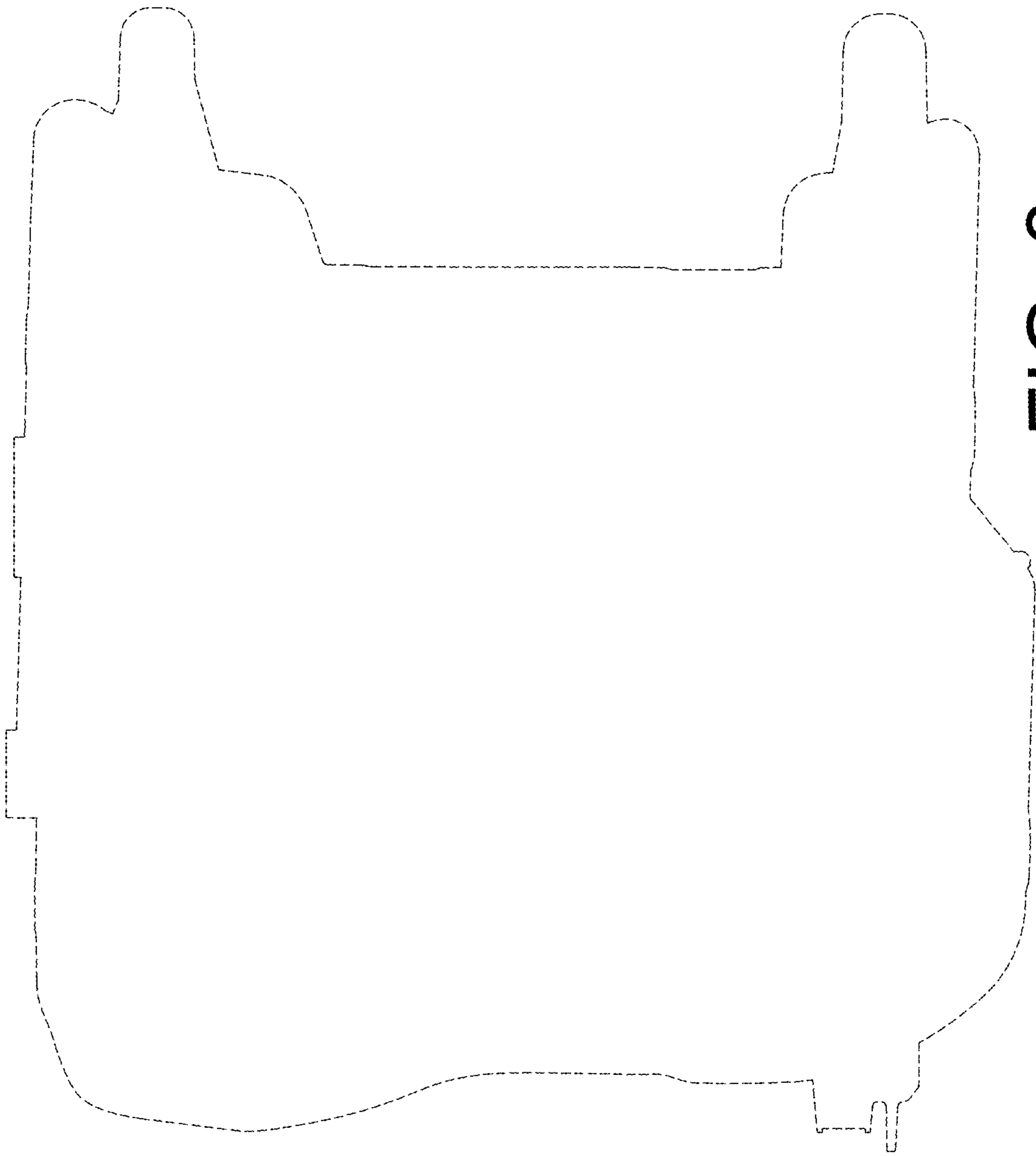

FIG. 3

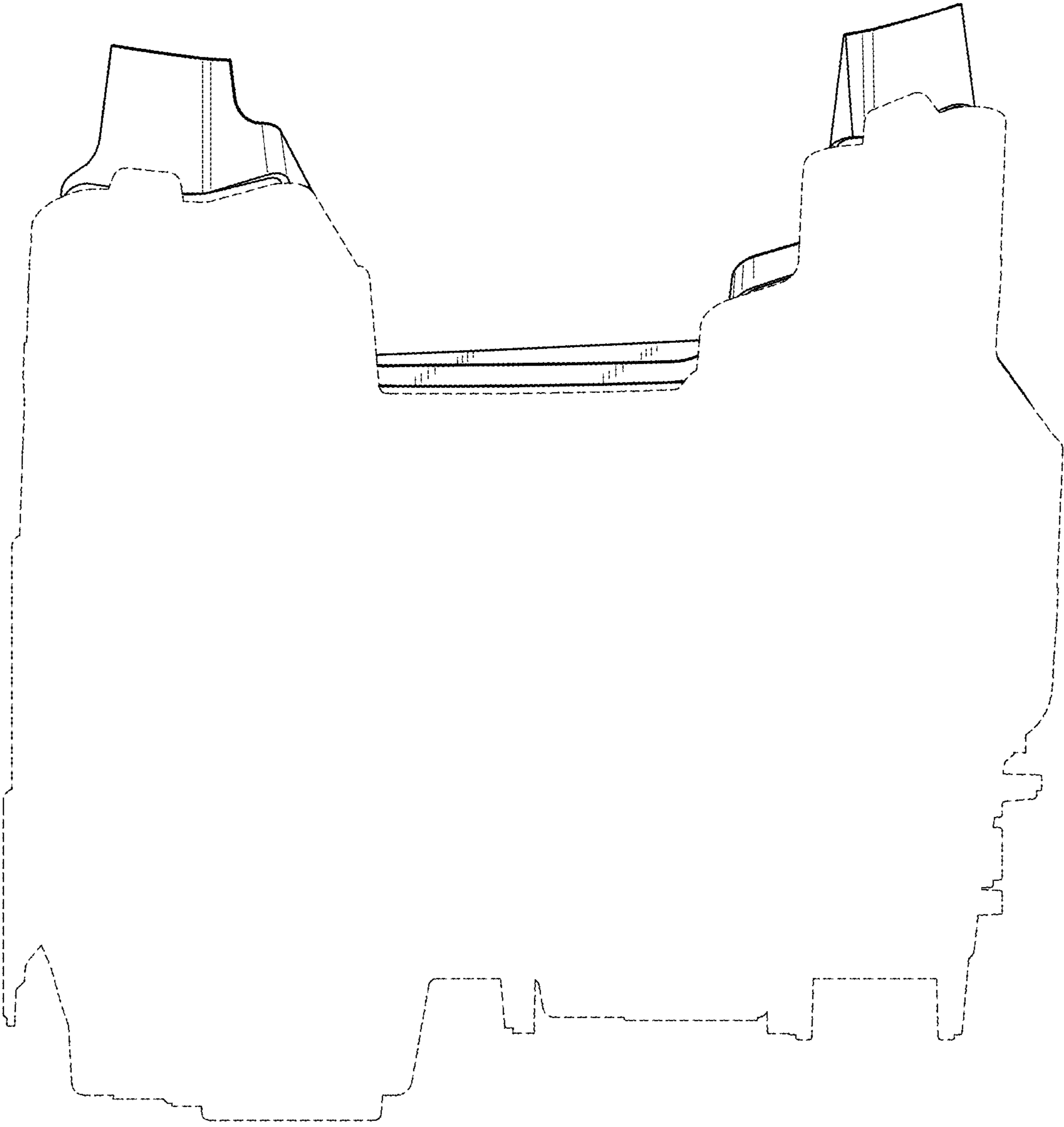

FIG. 4

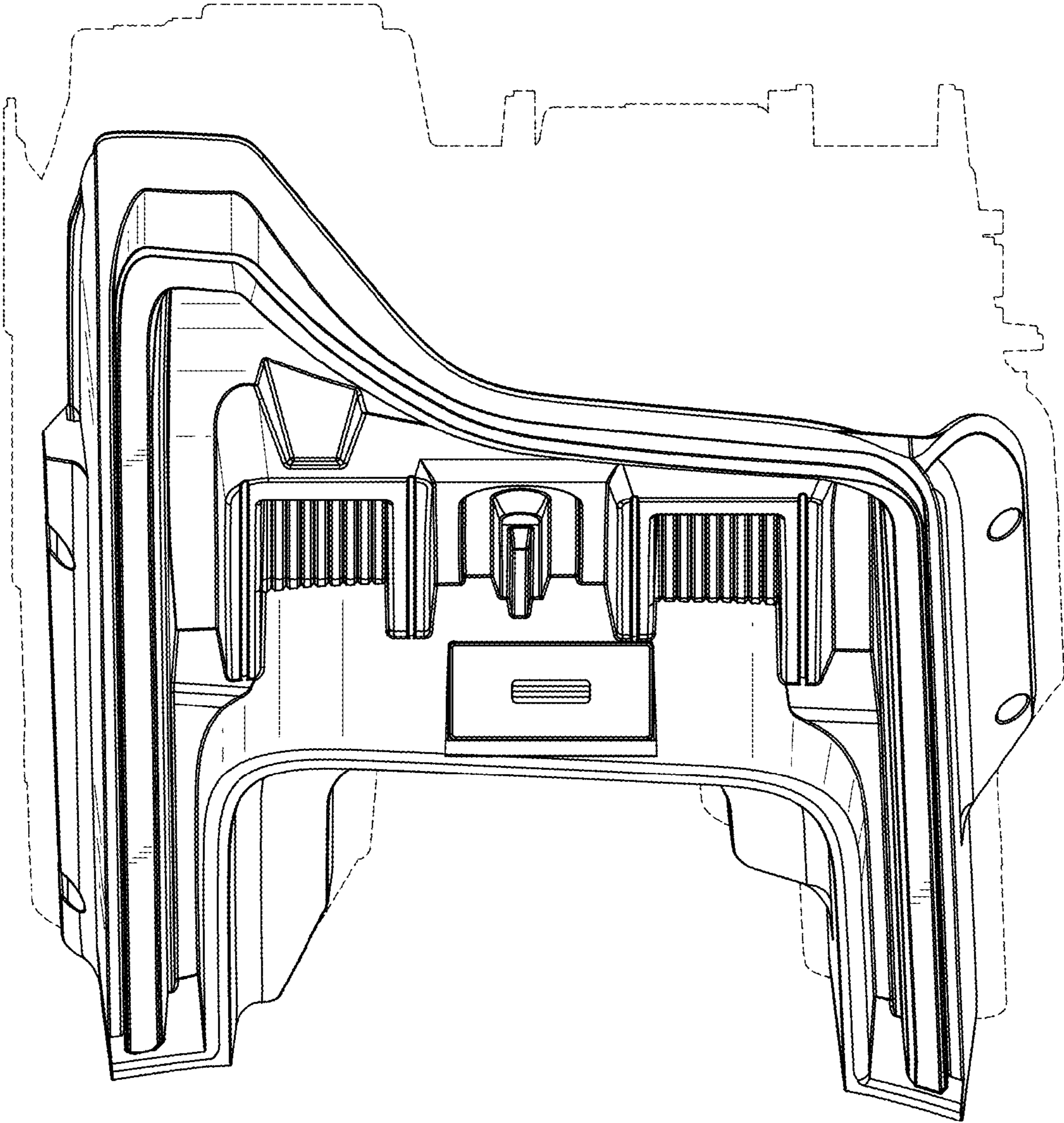

FIG. 5

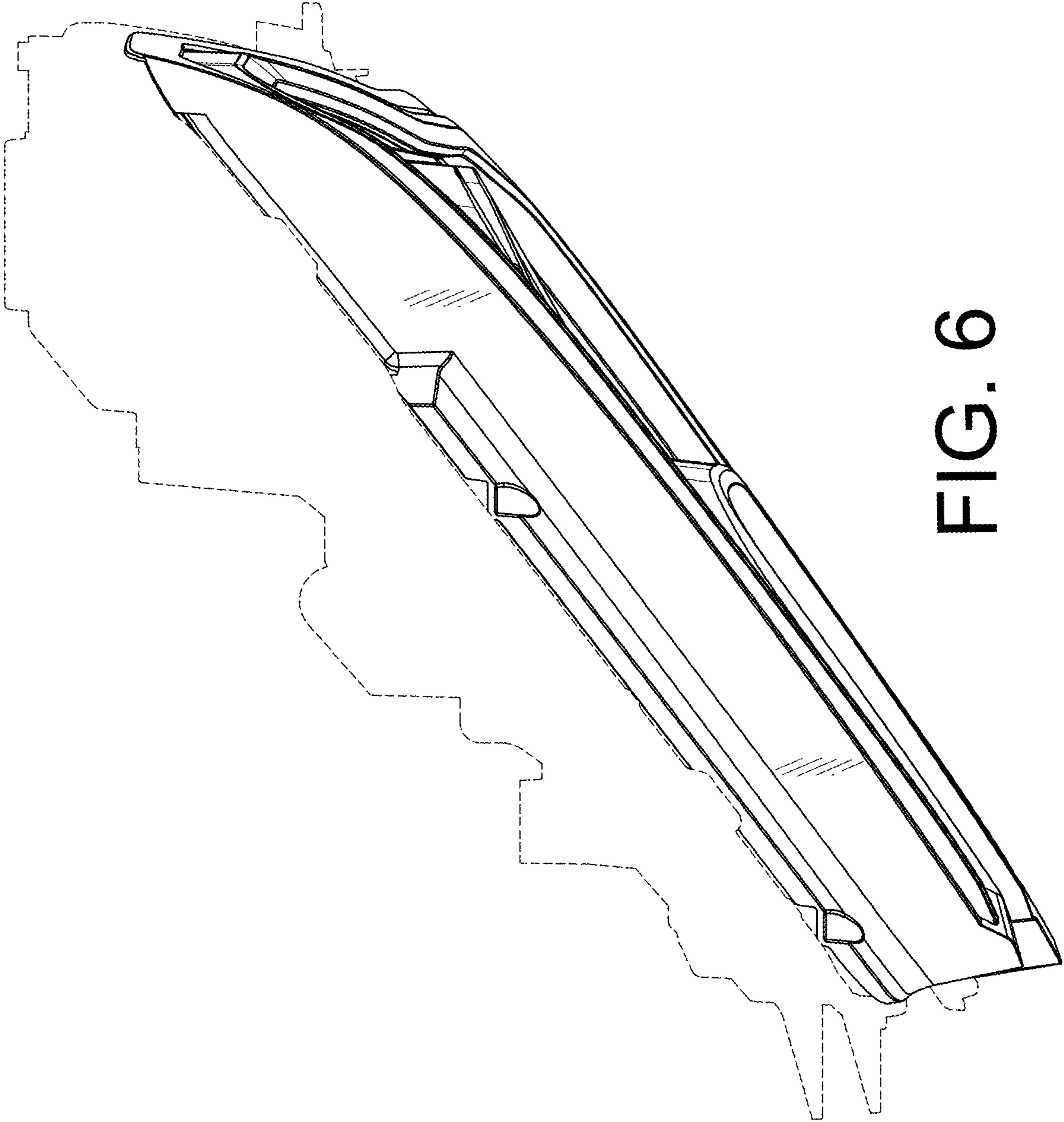

FIG. 6

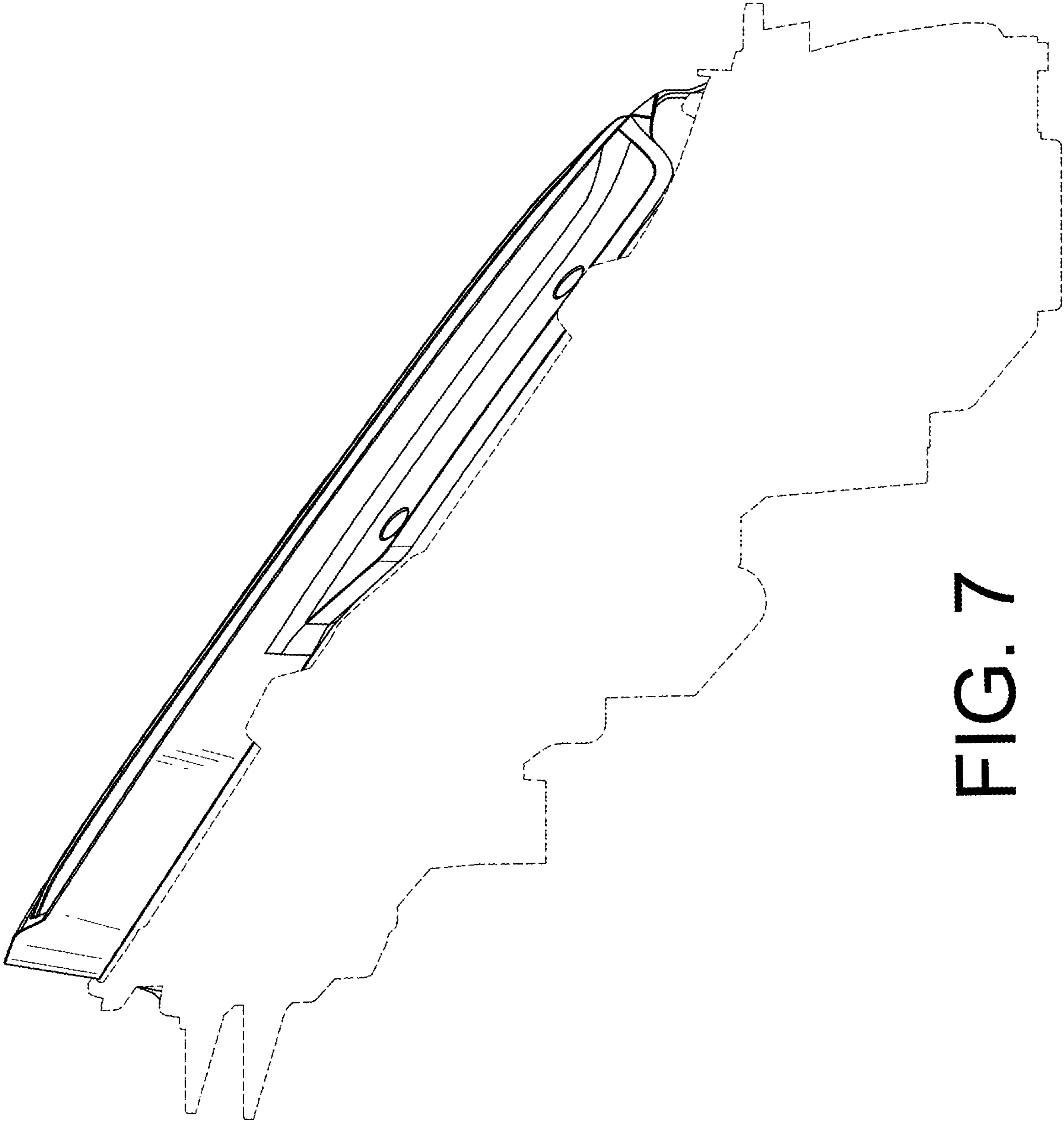

FIG. 7