



US00D890341S

(12) **United States Design Patent** (10) **Patent No.:** **US D890,341 S**
Wohnhaas et al. (45) **Date of Patent:** **** Jul. 14, 2020**

(54) **DENTAL CAMERA**

(56) **References Cited**

(71) Applicant: **Kaltenbach & Voigt GmbH**, Biberach an der Riss (DE)

U.S. PATENT DOCUMENTS

(72) Inventors: **Roland Wohnhaas**, Mittelbiberach (DE); **Carolin Frontzek**, Munich (DE); **Matthis Hamann**, Gruenwald (DE); **Christian Rogge**, Munich (DE)

D354,566	S	*	1/1995	Donahoo	D14/411
D414,867	S	*	10/1999	Moriwaki	D24/152
D630,747	S	*	1/2011	Shinohara	D24/137
D674,091	S	*	1/2013	Carlson	D24/152
D690,346	S	*	9/2013	Woolley	D16/200
D722,164	S	*	2/2015	Graham, II	D24/152
D742,518	S	*	11/2015	Barak	D24/158
D760,901	S	*	7/2016	Barak	D24/158
D785,176	S	*	4/2017	Tseng	D16/208
D862,697	S	*	10/2019	Kenworthy	D24/158
2012/0122051	A1	*	5/2012	Hackel	A61B 1/00096 433/29
2014/0313299	A1	*	10/2014	Gebhardt	A61B 1/24 348/66

(73) Assignee: **KALTENBACH & VOIGT GMBH**, Biberach an der Riss (DE)

(**) Term: **15 Years**

(21) Appl. No.: **29/674,918**

* cited by examiner

(22) Filed: **Dec. 27, 2018**

Primary Examiner — Wan Laymon

Assistant Examiner — Clint A Samuel

(30) **Foreign Application Priority Data**

(74) *Attorney, Agent, or Firm* — Scully Scott Murphy and Presser

Jun. 29, 2018 (DE) 40 2018 100 639

(51) **LOC (12) Cl.** **24-02**

(57) **CLAIM**

The ornamental design for a dental camera, as shown and described.

(52) **U.S. Cl.**

USPC **D24/152**; D24/158

DESCRIPTION

(58) **Field of Classification Search**

USPC D4/100, 101, 102, 104, 108, 110, 111, D4/127, 129; D24/107, 146, 152, 158, D24/176, 193, 194; D16/130, 131, 135, D16/200, 208; D14/411

CPC A61C 15/00; A61C 15/047; A61C 15/048; A61C 17/16; A61C 17/18; A61C 17/32; A61C 17/34; A61C 3/06; A46B 5/0008; A46B 5/0095; A46B 2200/10; A46B 2200/108; A46B 2200/1026; A46B 2200/1066; A46B 2200/1073; A46B 9/04; A61B 1/24

FIG. 1 illustrates a perspective view of a dental camera showing our new and ornamental design; FIG. 2 illustrates a left side elevation view thereof; FIG. 3 illustrates a right side elevation view thereof; FIG. 4 illustrates a bottom plan view thereof; FIG. 5 illustrates a top plan view thereof; FIG. 6 illustrates back elevation view thereof; and, FIG. 7 illustrates a front elevation view thereof. The broken lines are included for the purpose of illustrating portions of the dental camera that form no part of the claimed design.

See application file for complete search history.

1 Claim, 7 Drawing Sheets

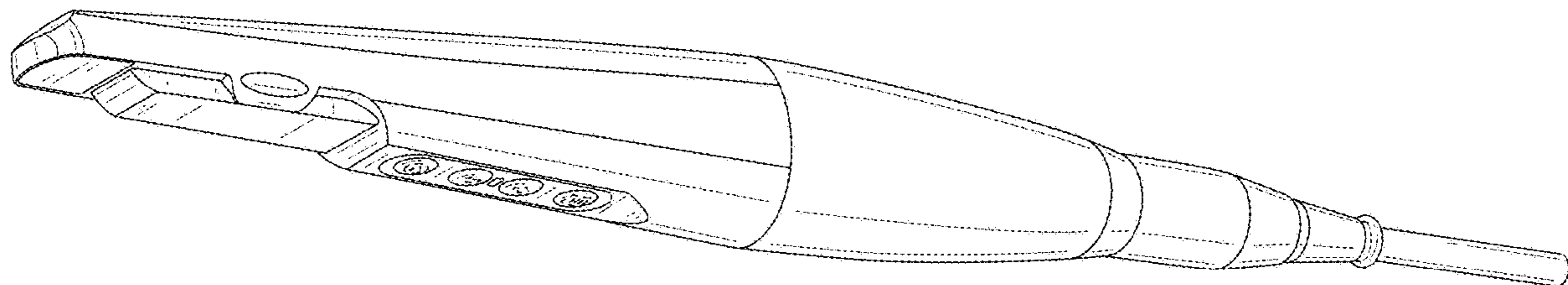

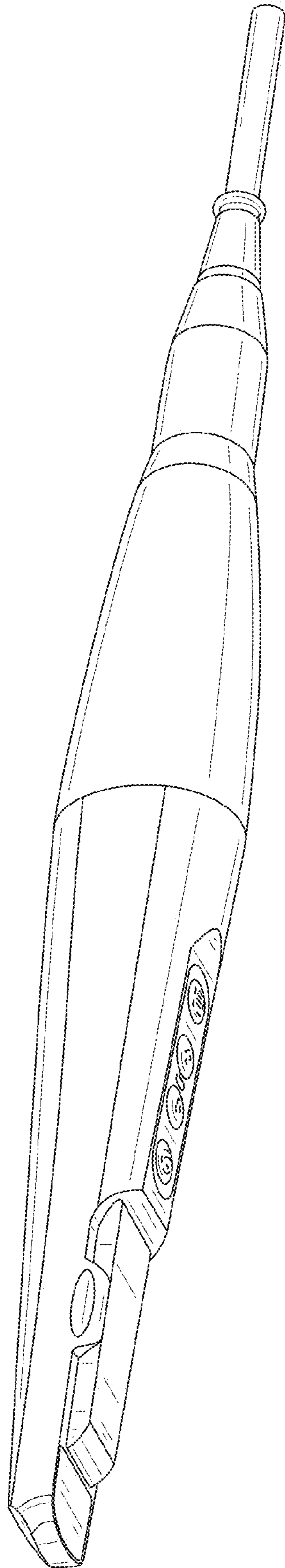

FIG. 1

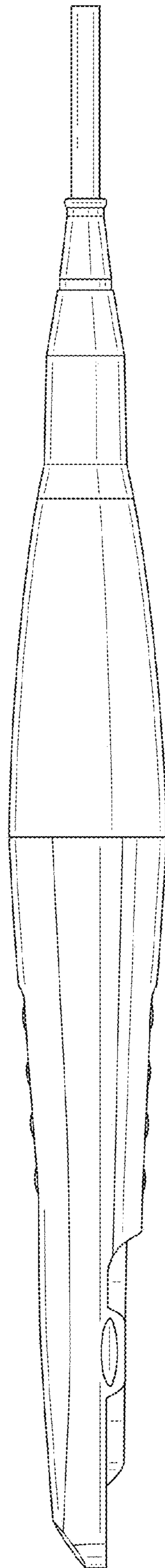

FIG. 2

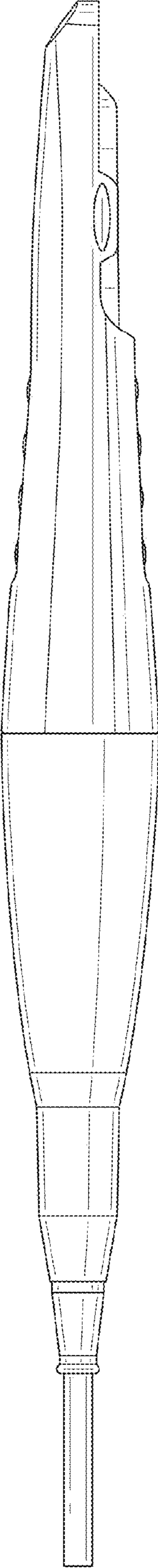

FIG. 3

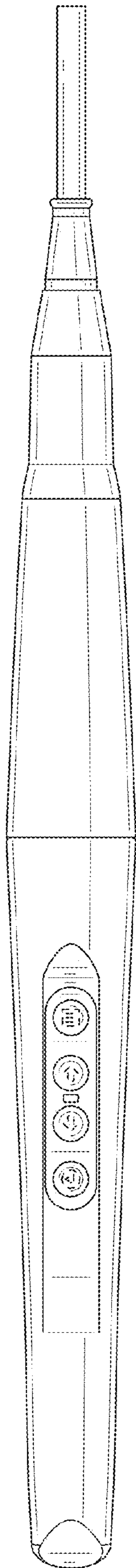

FIG. 4

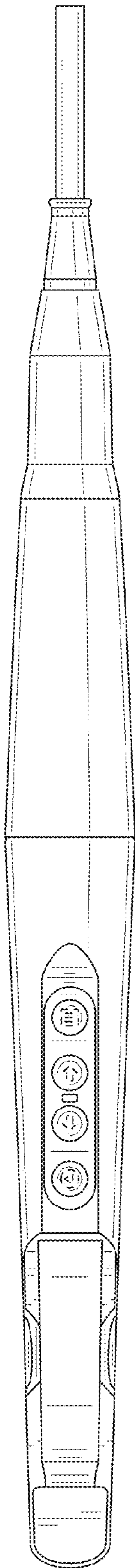

FIG. 5

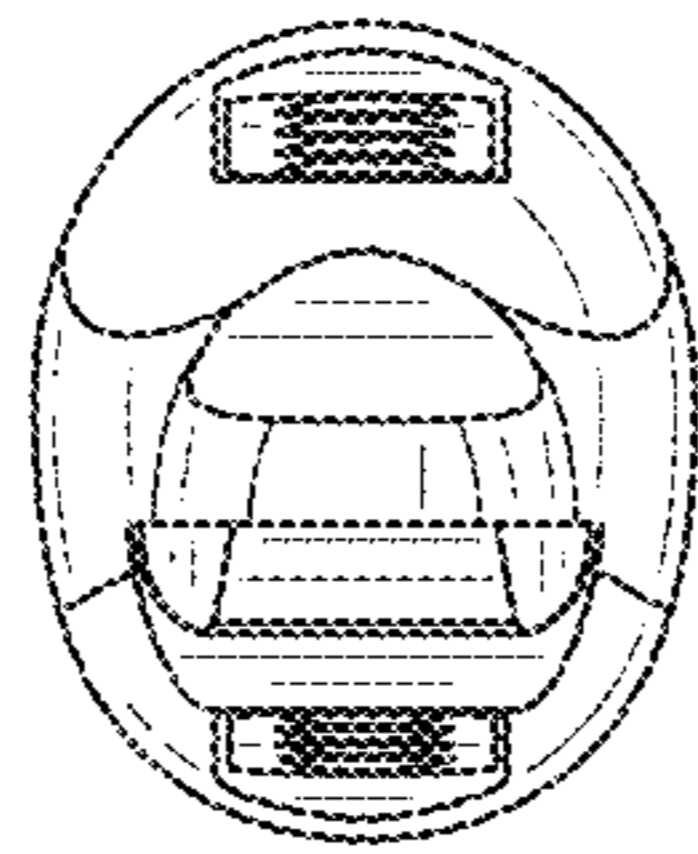

FIG. 6

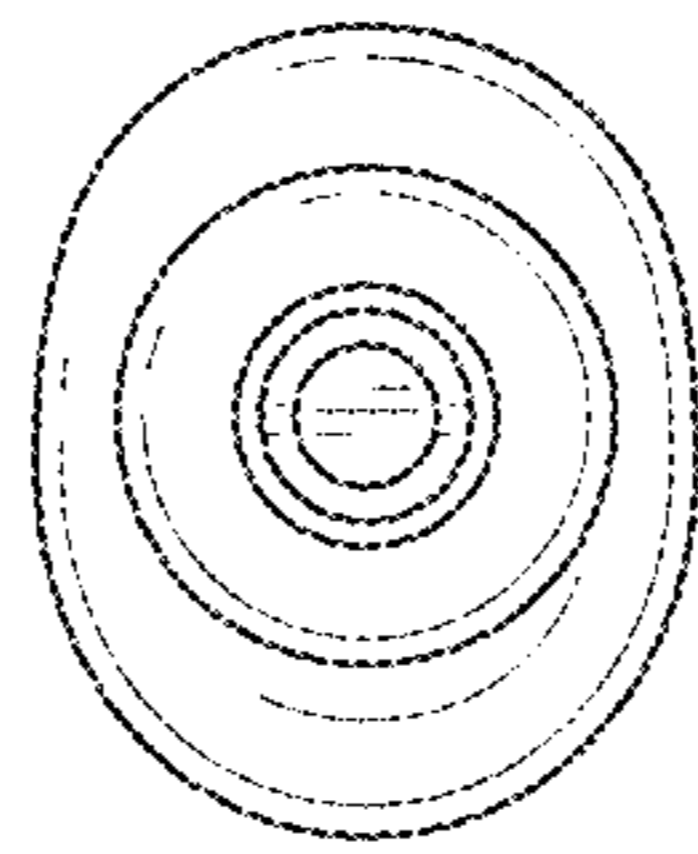

FIG. 7