



US00D890302S

(12) **United States Design Patent**
Chen

(10) **Patent No.:** **US D890,302 S**

(45) **Date of Patent:** **** Jul. 14, 2020**

(54) **FAUCET**

(71) Applicant: **Yun Chen**, Ruian (CN)

(72) Inventor: **Yun Chen**, Ruian (CN)

(**) Term: **15 Years**

(21) Appl. No.: **29/670,486**

(22) Filed: **Nov. 16, 2018**

(51) **LOC (12) Cl.** **23-01**

(52) **U.S. Cl.**
USPC **D23/238**

(58) **Field of Classification Search**
USPC D23/238, 241–243, 249–250, 252,
D23/254–255, 257, 226; D8/307–308
CPC Y10T 137/9464; Y10T 137/6014; Y10T
137/6017
See application file for complete search history.

(56) **References Cited**

U.S. PATENT DOCUMENTS

D674,882 S * 1/2013 Kwok D23/252
D686,300 S * 7/2013 Fritz D23/238
D786,407 S * 5/2017 Clarke D23/252

D810,874 S * 2/2018 Bahler D23/238
D839,996 S * 2/2019 Garland D23/252
D849,201 S * 5/2019 Zhang D23/238

* cited by examiner

Primary Examiner — Robert A Delehanty

(74) *Attorney, Agent, or Firm* — Law Offices of Steven
W. Weinrieb

(57) **CLAIM**

The ornamental design for a faucet, as shown and described.

DESCRIPTION

FIG. 1 is a front, right side, top perspective view of the faucet showing my new design;
FIG. 2 is a rear, left side, bottom perspective view thereof;
FIG. 3 is a front elevational view thereof;
FIG. 4 is a rear elevational view thereof;
FIG. 5 is a left side elevational view thereof;
FIG. 6 is a right side elevational view thereof;
FIG. 7 is a top plan view thereof; and,
FIG. 8 is a bottom plan view thereof.
The broken lines immediately adjacent to the claimed portions are boundaries, all other broken lines are environmental structures; all the broken lines form no part of the claimed design.

1 Claim, 8 Drawing Sheets

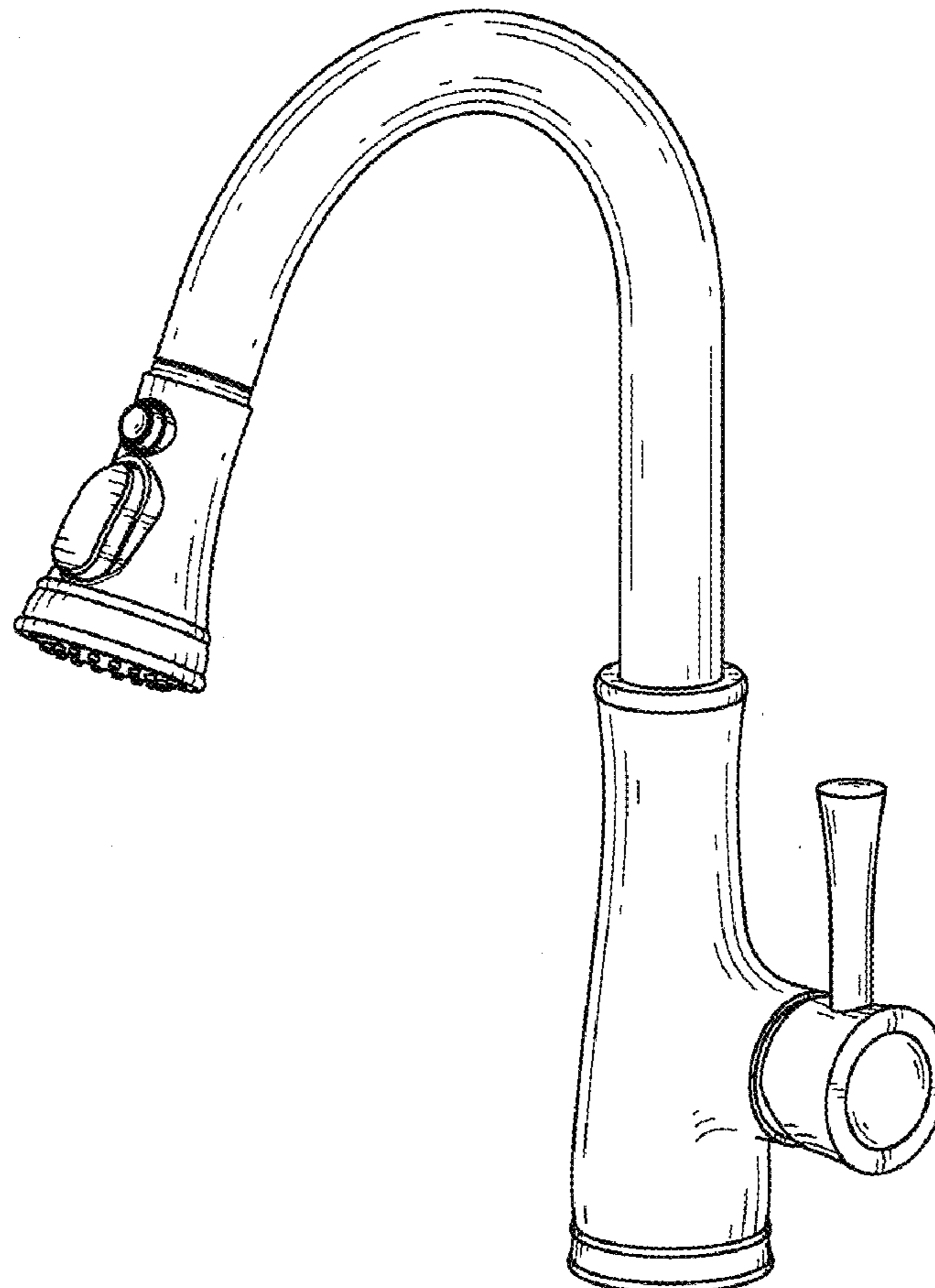

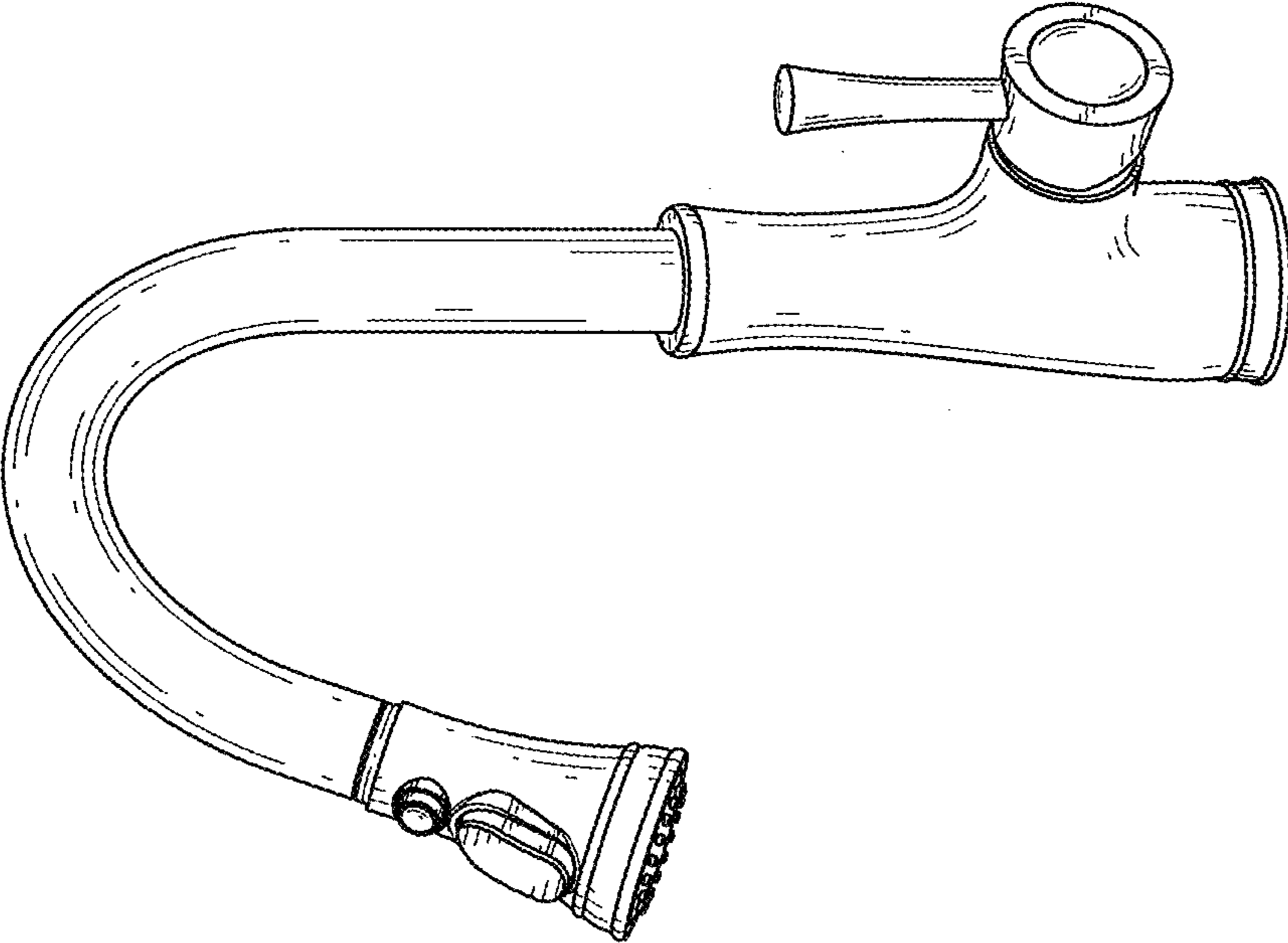

FIG. 1

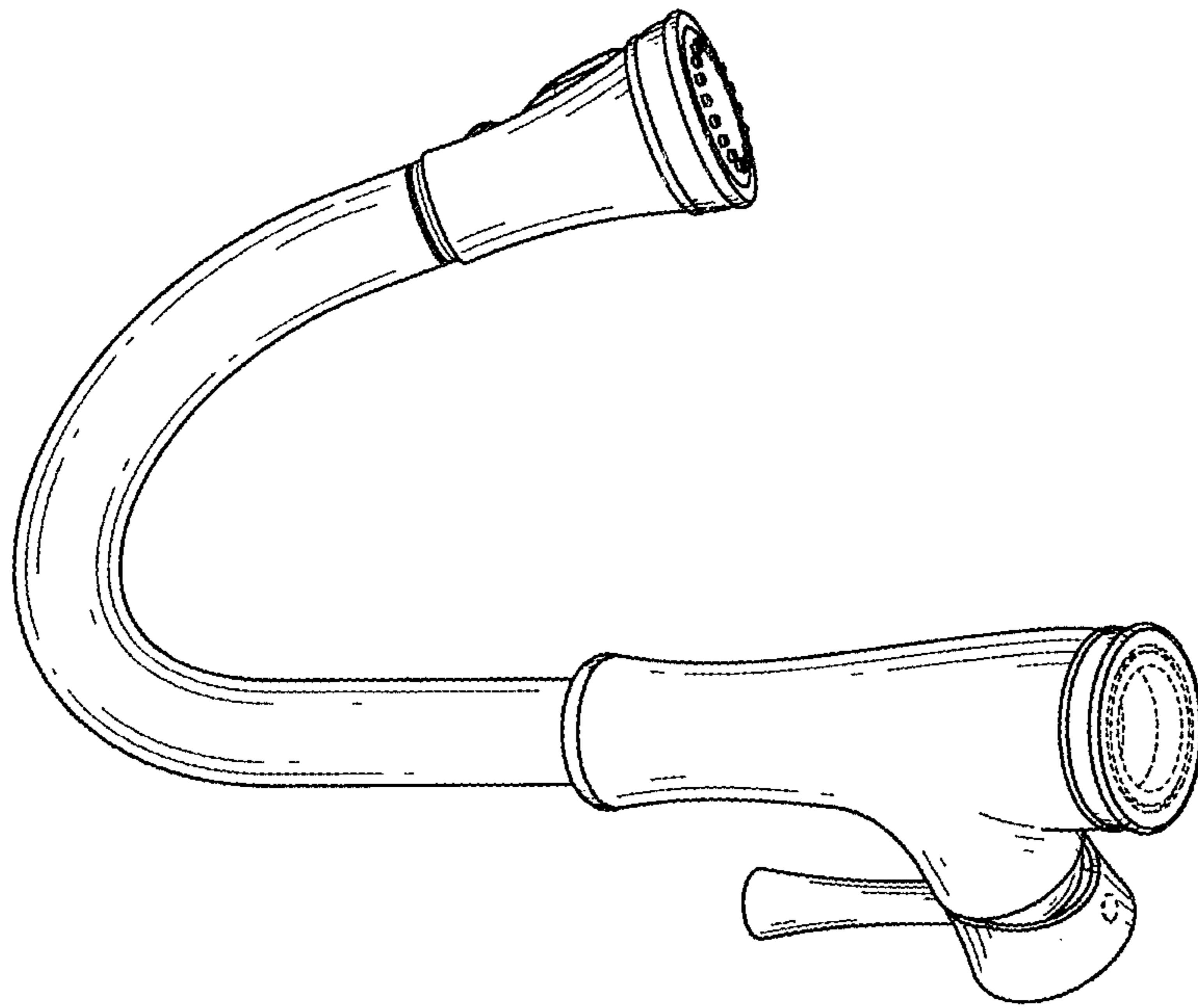

FIG. 2

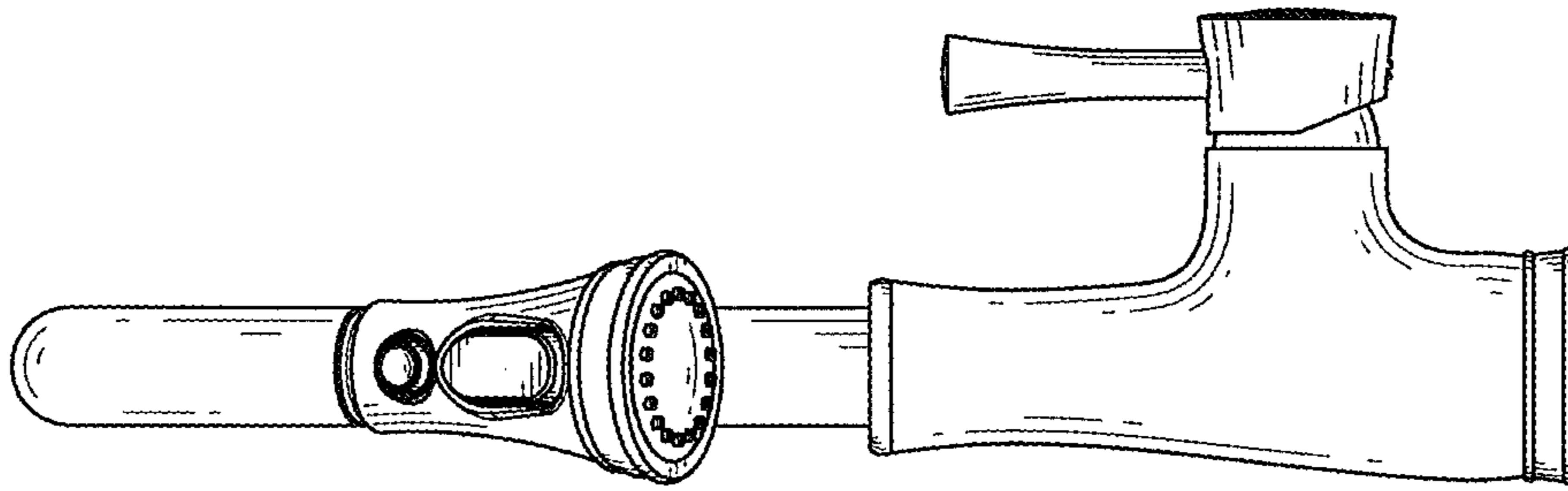

FIG. 3

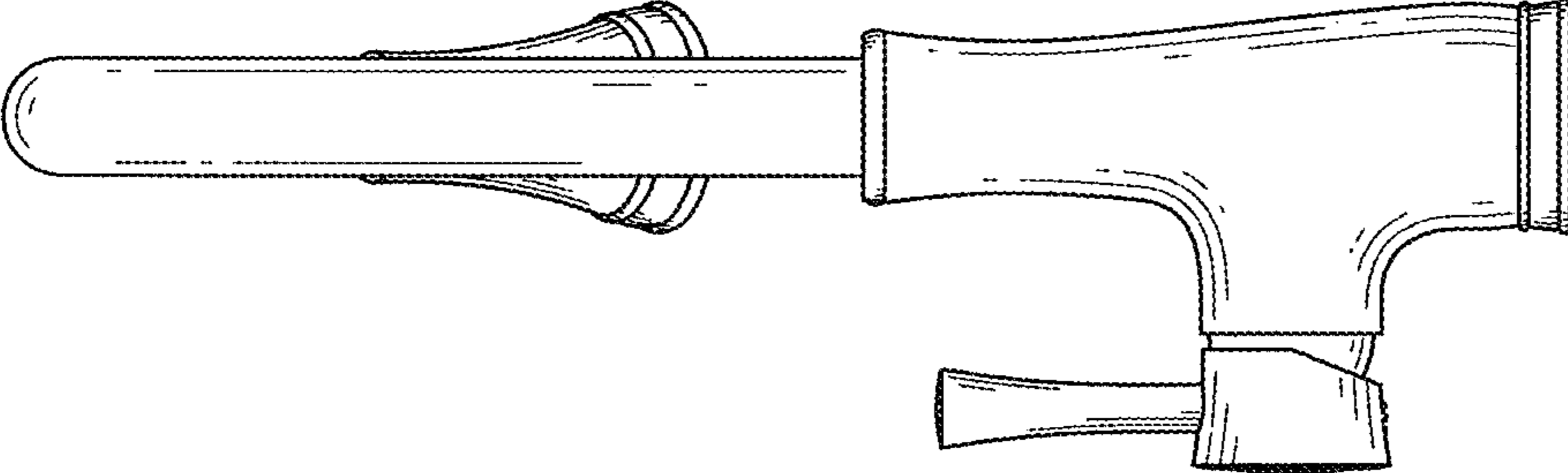

FIG. 4

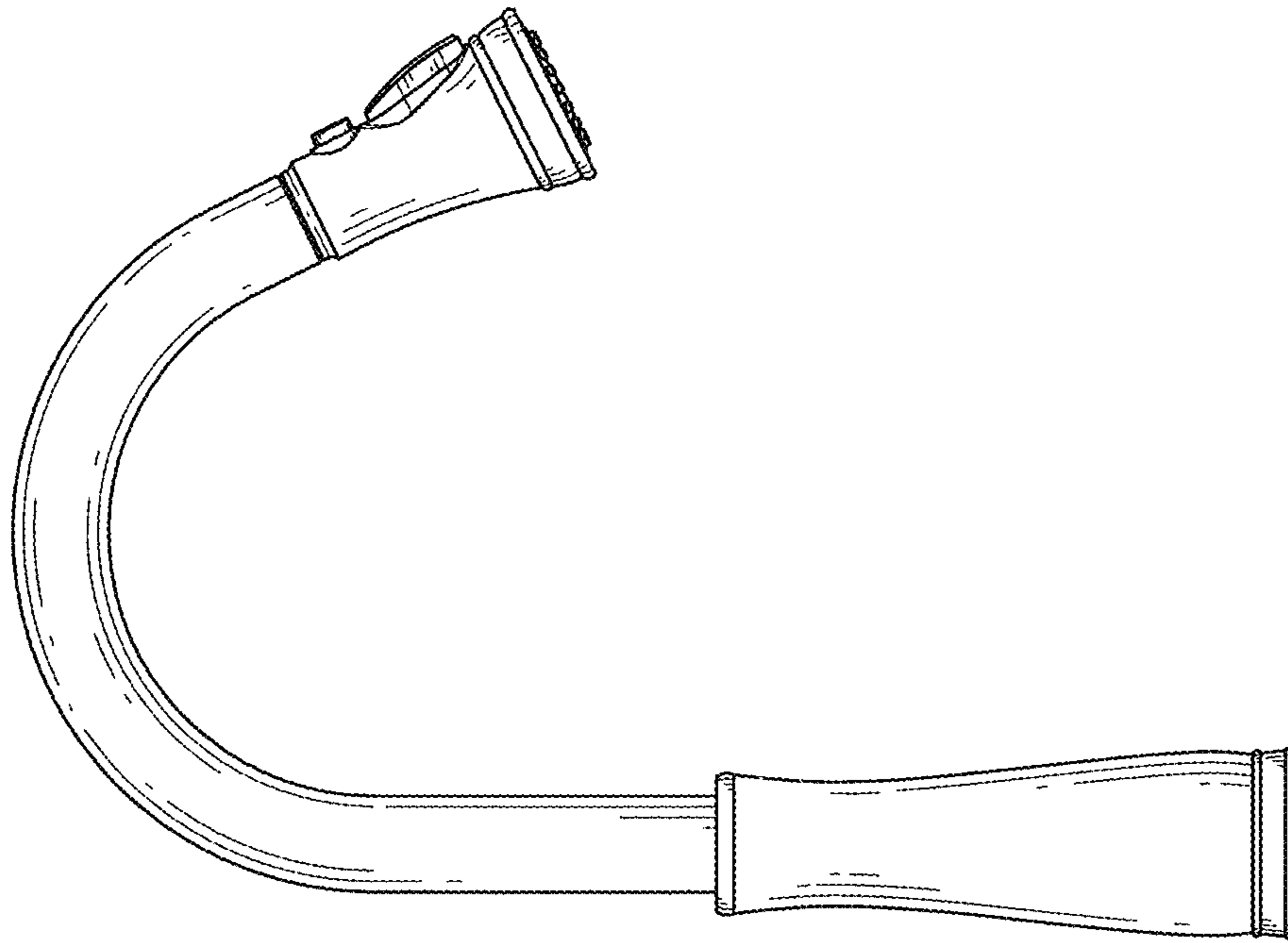

FIG. 5

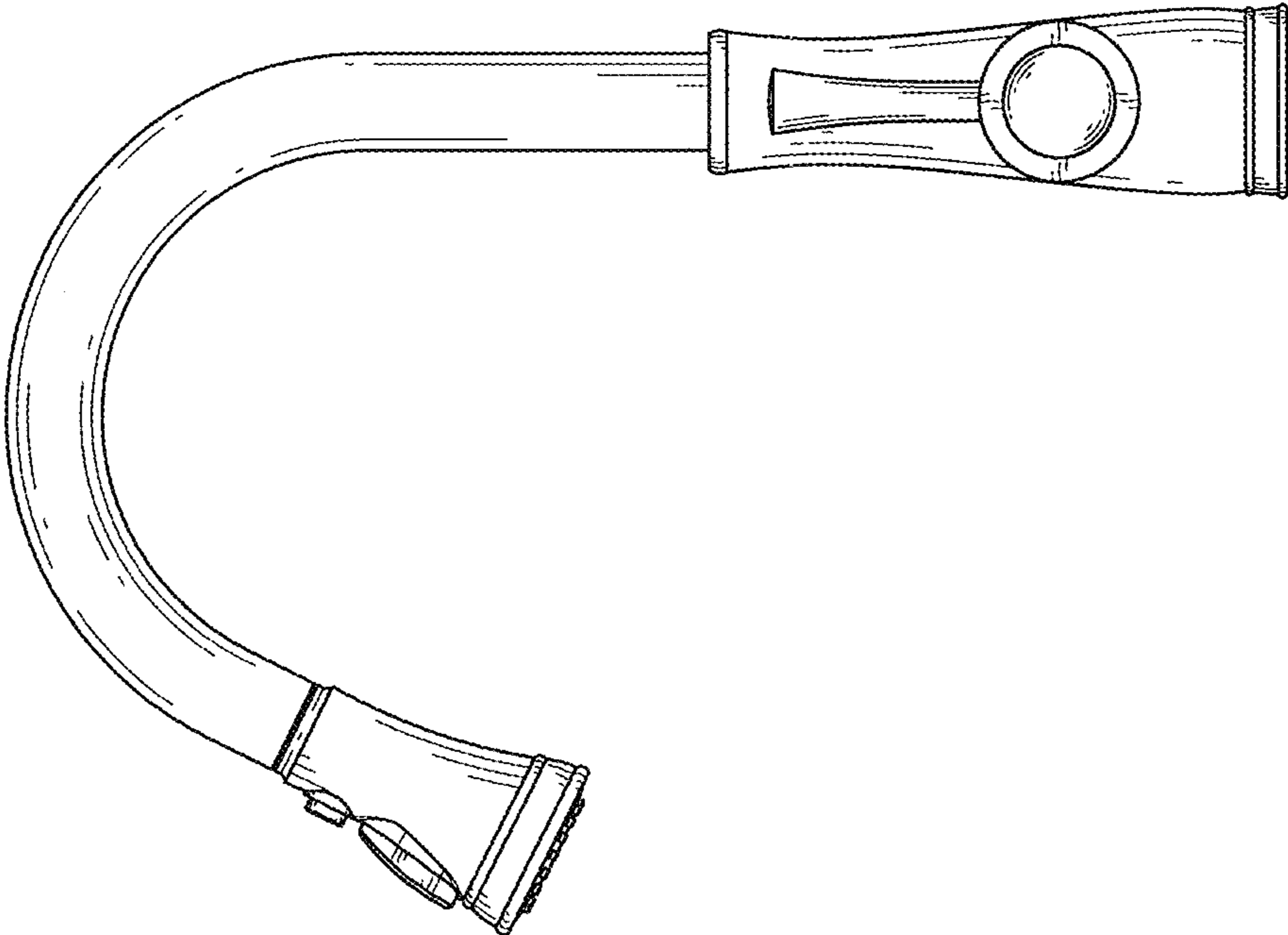

FIG. 6

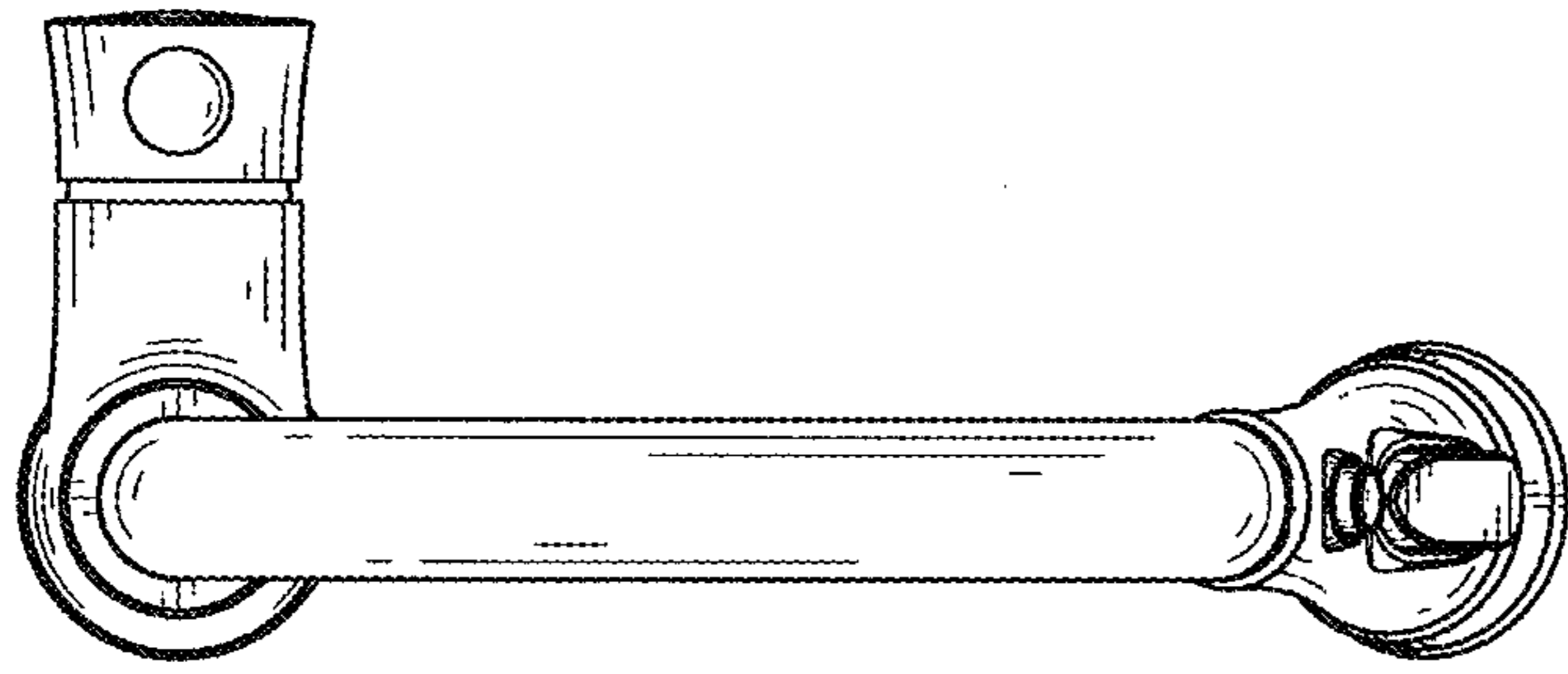

FIG. 7

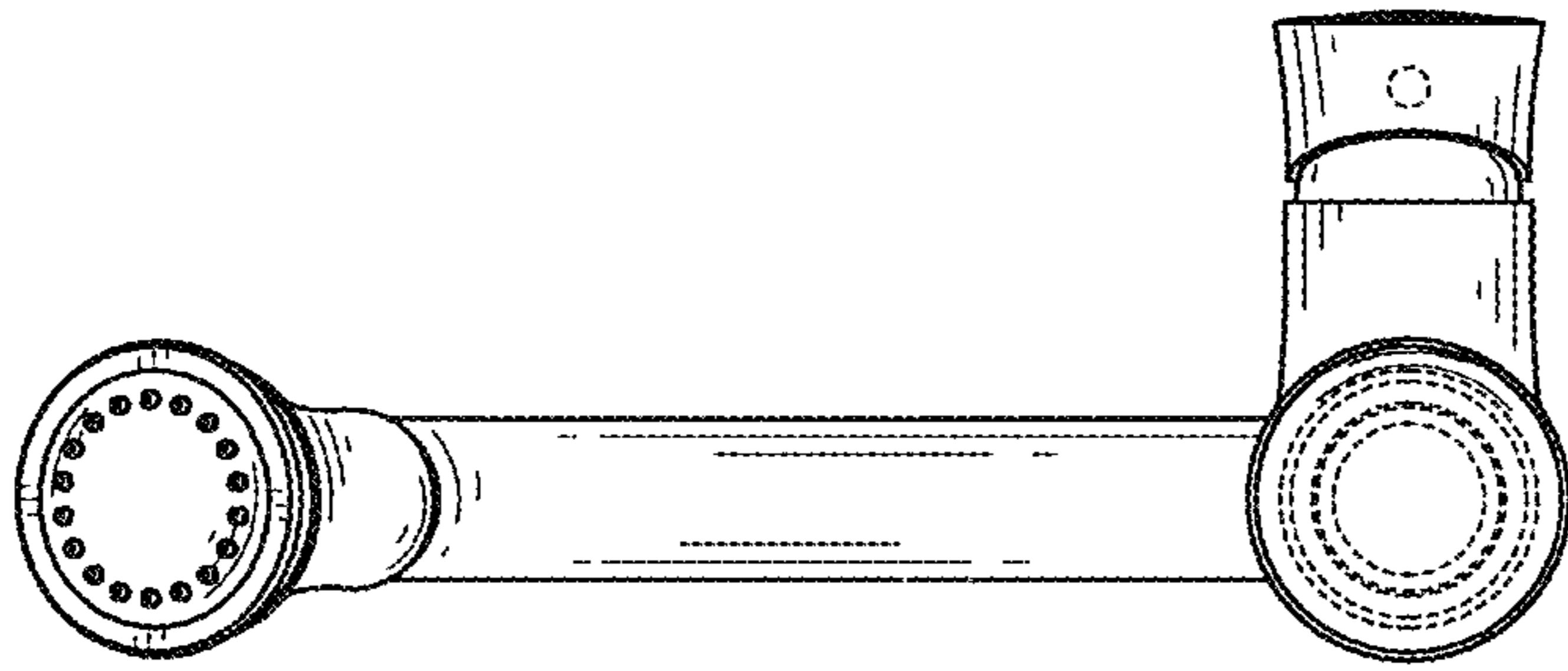

FIG. 8