



US00D890287S

(12) **United States Design Patent**
Hymowitz

(10) **Patent No.:** **US D890,287 S**

(45) **Date of Patent:** **** Jul. 14, 2020**

(54) **PERSONAL SECURITY RESPONSE APPARATUS**

(71) Applicant: **Pangaea Services, Inc.**, Sequim, WA (US)

(72) Inventor: **Steven Allen Hymowitz**, Sequim, WA (US)

(**) Term: **15 Years**

(21) Appl. No.: **29/673,046**

(22) Filed: **Dec. 11, 2018**

(51) **LOC (12) Cl.** **22-02**

(52) **U.S. Cl.**
USPC **D22/117**

(58) **Field of Classification Search**
USPC D22/117; D10/104.1
CPC B65D 83/206; F41H 9/10
See application file for complete search history.

(56) **References Cited**

U.S. PATENT DOCUMENTS

- D375,994 S * 11/1996 Collins D22/117
- 7,121,432 B2 * 10/2006 Kostal F41H 9/10
222/192
- D585,520 S * 1/2009 Teig D22/117
- D636,050 S * 4/2011 Kaufman D22/117
- 8,397,953 B2 * 3/2013 Kaufman B65D 83/206
222/113
- D681,768 S * 5/2013 Ross, Jr. D22/117

- 8,556,125 B2 * 10/2013 Dapper F41H 9/10
222/113
- D723,131 S * 2/2015 Habermann D22/117
- D747,433 S * 1/2016 Cravens D22/117
- D829,297 S * 9/2018 Sheikh D22/117
- D838,337 S * 1/2019 Frisk D22/117
- D874,605 S * 2/2020 Yang D22/117
- D874,607 S * 2/2020 Ni D22/117
- D875,876 S * 2/2020 Yang D22/117
- 2014/0166782 A1 * 6/2014 Hwang F41H 9/10
239/373

* cited by examiner

Primary Examiner — George D. Kirschbaum

(57) **CLAIM**

I claim the ornamental design for a personal security response apparatus, as shown and described.

DESCRIPTION

FIG. 1 is a front perspective view of a personal security response apparatus showing my new design; FIG. 2 is a front elevation view thereof; FIG. 3 is a back elevation view thereof; FIG. 4 is a right-side elevation view thereof; FIG. 5 is a left-side elevation view thereof; FIG. 6 is a top plan view thereof; and, FIG. 7 is a bottom plan view thereof.

1 Claim, 6 Drawing Sheets

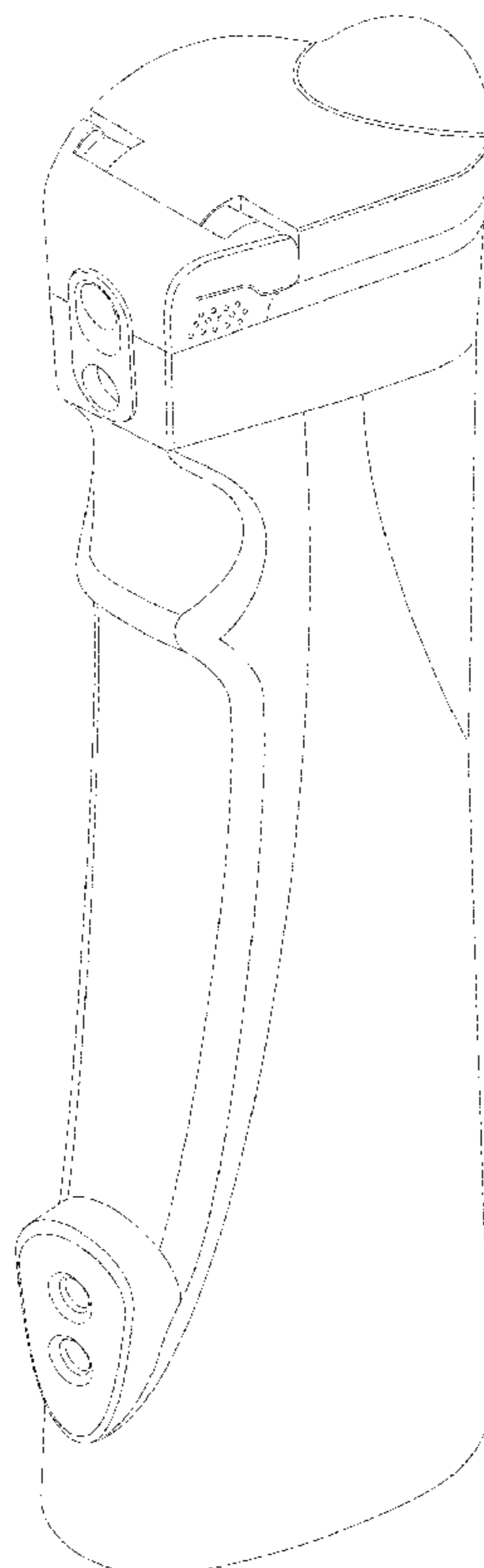

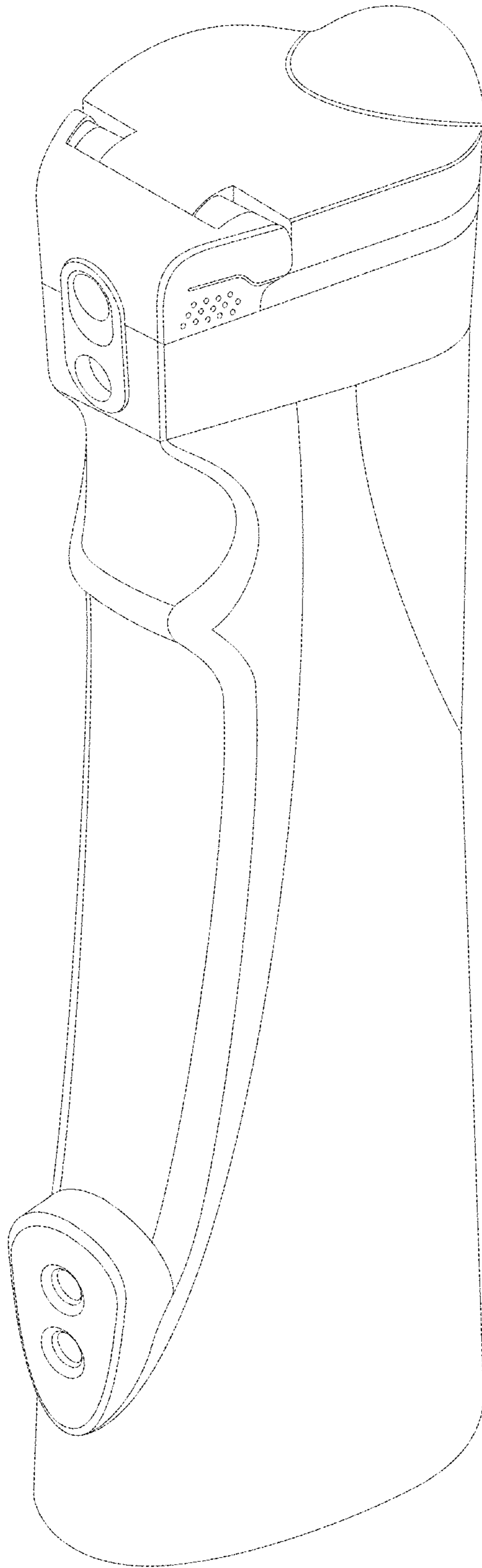

FIG. 1

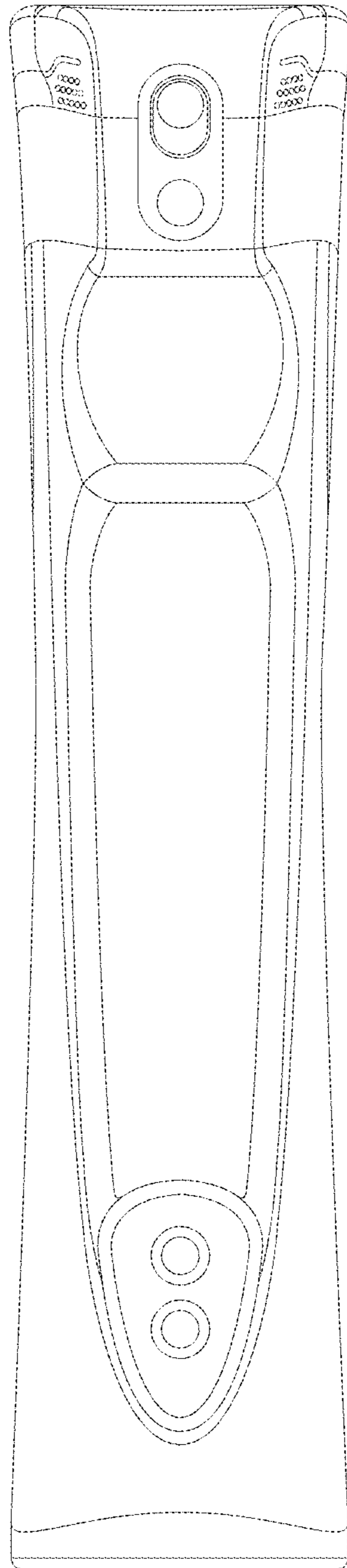

FIG. 2

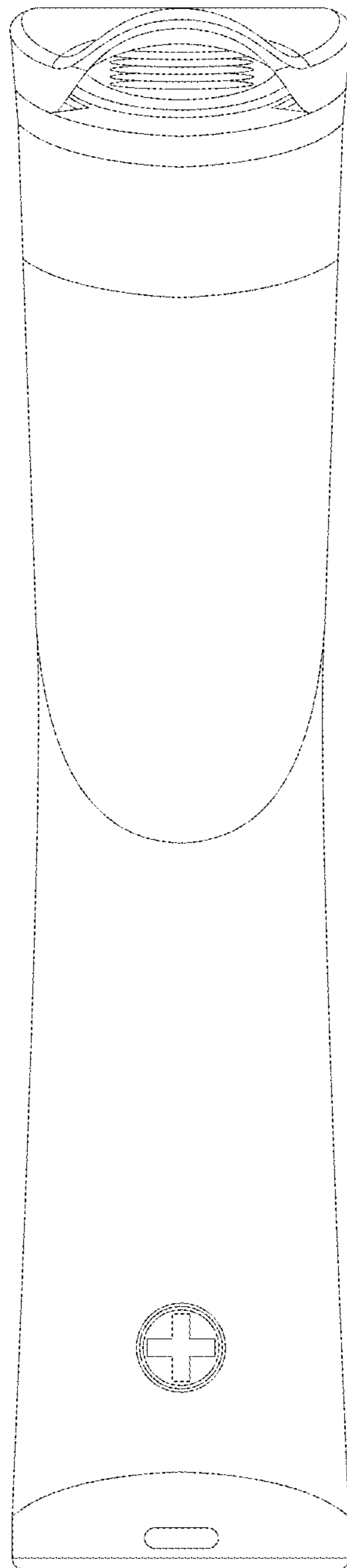

FIG. 3

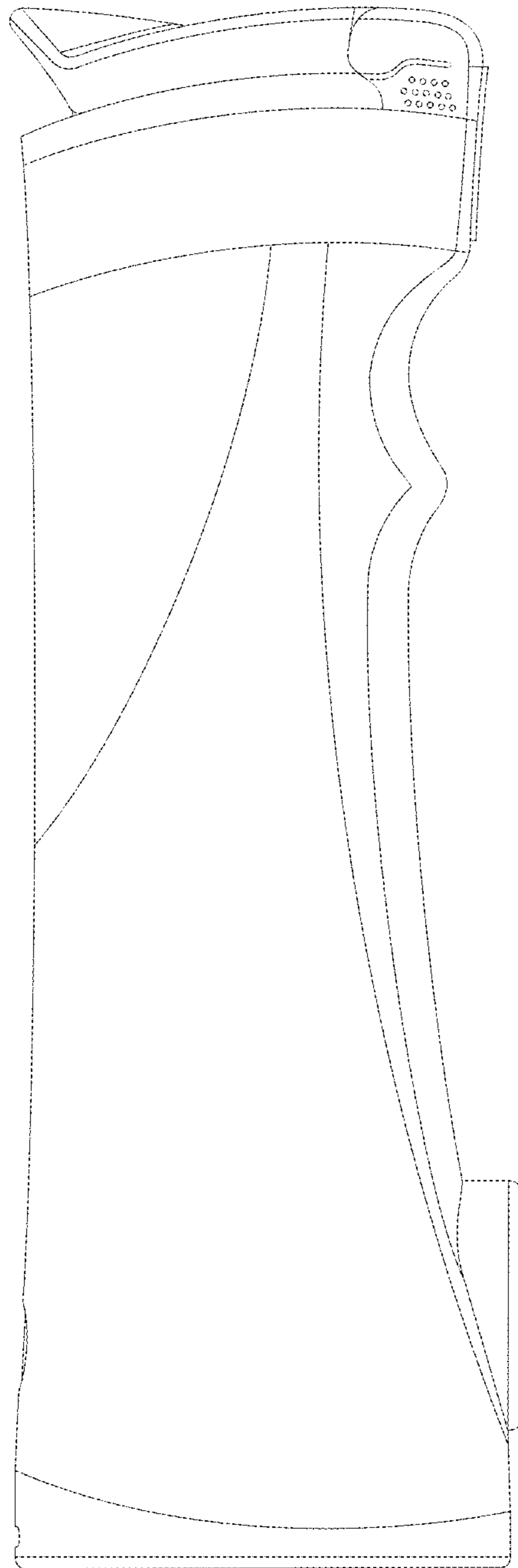

FIG. 4

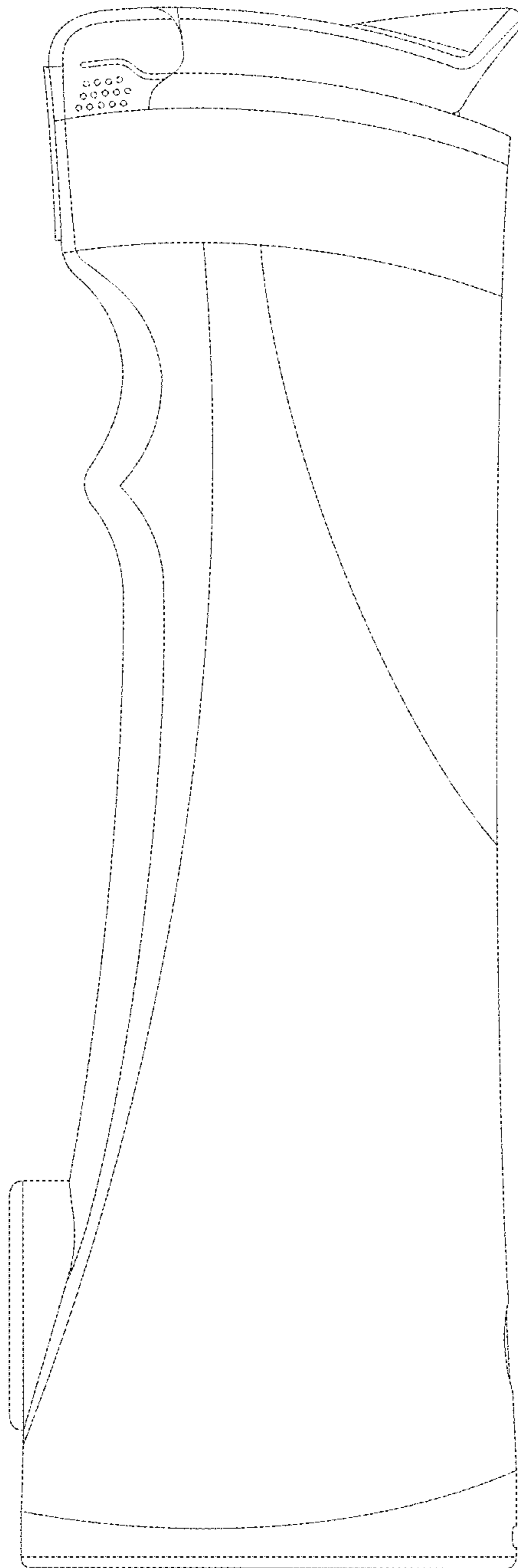

FIG. 5

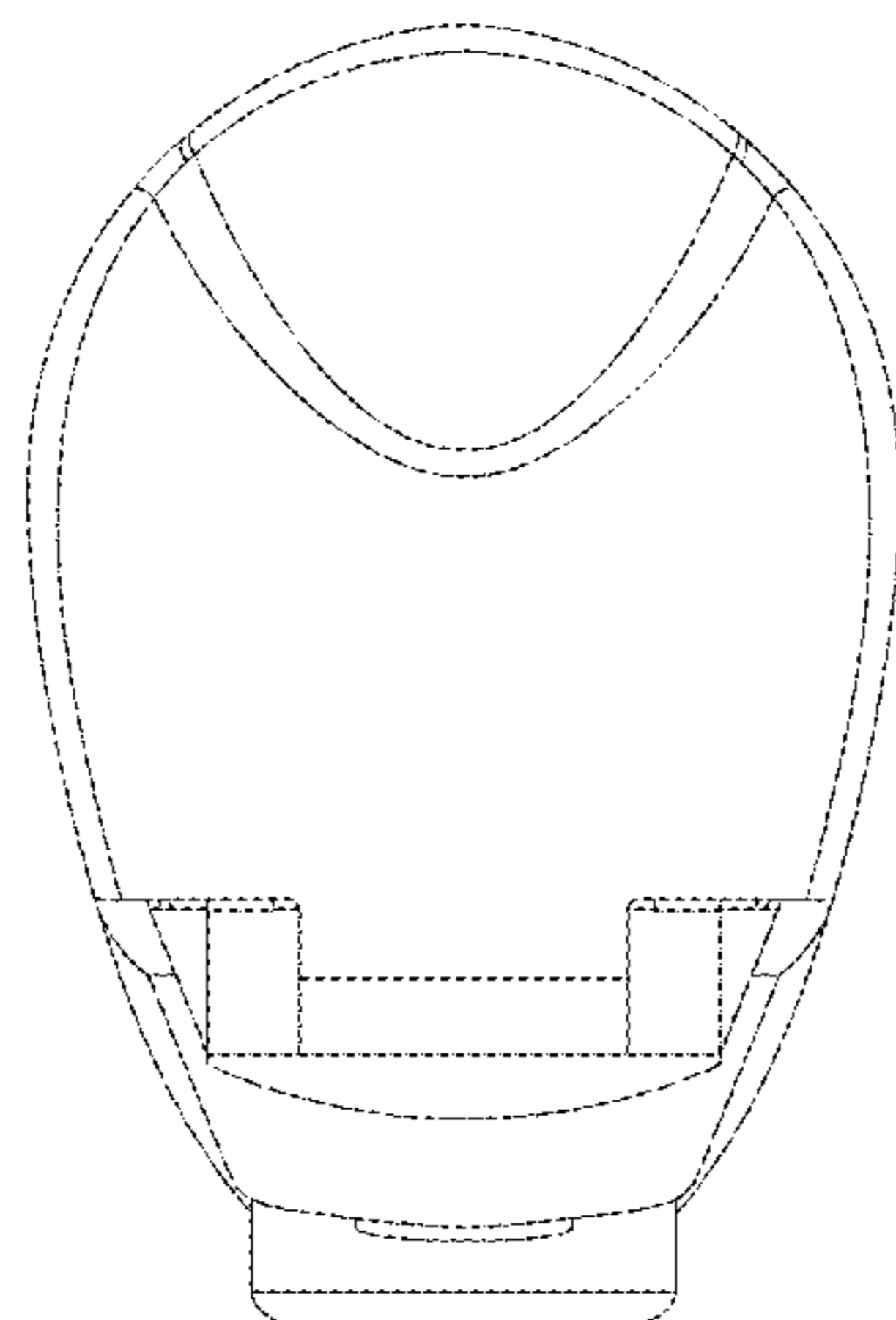

FIG. 6

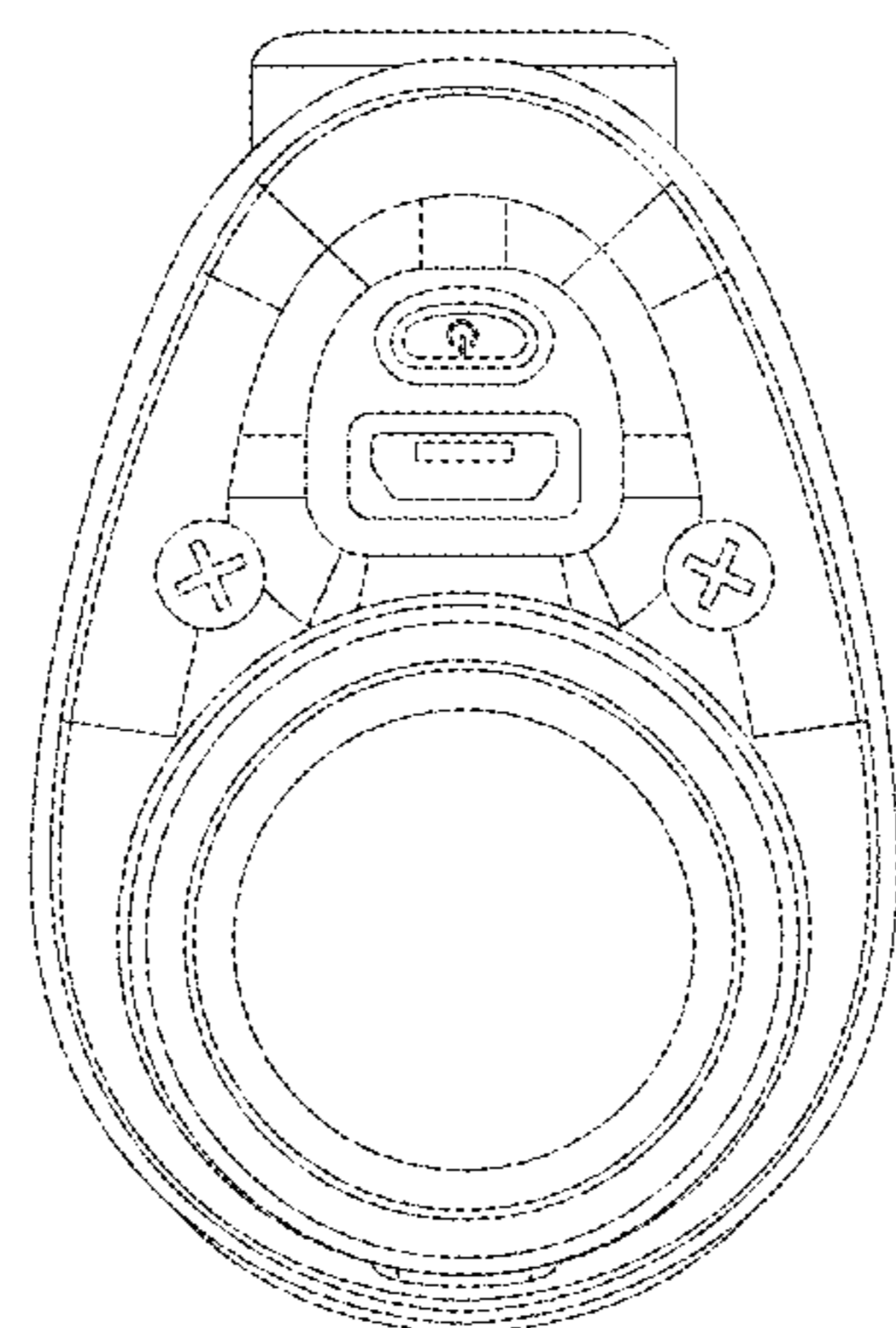

FIG. 7