



US00D890183S

(12) **United States Design Patent**
Zhao

(10) **Patent No.:** **US D890,183 S**

(45) **Date of Patent:** **** Jul. 14, 2020**

(54) **TABLET PC PROTECTION COVER**

(71) Applicant: **Chenghe Zhao**, Dongguan (CN)

(72) Inventor: **Chenghe Zhao**, Dongguan (CN)

(**) Term: **15 Years**

(21) Appl. No.: **29/672,040**

(22) Filed: **Dec. 3, 2018**

(51) **LOC (12) Cl.** **14-02**

(52) **U.S. Cl.**
USPC **D14/440**

(58) **Field of Classification Search**
USPC D14/440, 447, 250, 432; 206/45.23, 320,
206/45.2; 361/679.55; 294/25; 224/218
CPC G06F 1/1628; G06F 1/1626; A47B 23/044
See application file for complete search history.

(56) **References Cited**

U.S. PATENT DOCUMENTS

D600,699 S *	9/2009	Johnston	D14/440
D678,884 S *	3/2013	Phillips	D14/440
D696,256 S *	12/2013	Piedra	D14/440
D718,769 S *	12/2014	Bassil	D14/440
D722,059 S *	2/2015	Hirst	D14/440
D724,092 S *	3/2015	Zangari	D14/440
D729,810 S *	5/2015	Klusener	D14/440
D749,592 S *	2/2016	Huang	D14/440
D760,708 S *	7/2016	Hirst	D14/250
D765,663 S *	9/2016	Shih	D14/440
D784,447 S *	4/2017	Iacchetti	D19/26
D787,520 S *	5/2017	Wall	D14/440

D817,962 S *	5/2018	Shao	D14/440
D820,908 S *	6/2018	Iacchetti	D19/26
D821,491 S *	6/2018	Park	D19/26
D845,305 S *	4/2019	Xu	D14/440
D846,552 S *	4/2019	Feng	D14/440
D853,401 S *	7/2019	Moore	D14/440
2016/0011628 A1 *	1/2016	Sato	G06F 1/1656 361/679.3

* cited by examiner

Primary Examiner — Cynthia R Underwood

(57) **CLAIM**

The ornamental design for a tablet PC protection cover, as shown and described.

DESCRIPTION

FIG. 1 is a perspective view of a tablet PC protection cover; FIG. 2 is a front elevational view of thereof; FIG. 3 is a rear elevational view thereof; FIG. 4 is a left side elevational view thereof; FIG. 5 is a right side elevational view thereof; FIG. 6 is a top plan view thereof; FIG. 7 is a bottom plan view thereof; FIG. 8 is another perspective view thereof; FIG. 9 is a perspective thereof shown with the strap in an alternate configuration of use; and, FIG. 10 is an enlarged view showing one part of FIG. 8. In the drawings, the broken lines illustrate portions of the article that form no part of the claimed design.

1 Claim, 8 Drawing Sheets

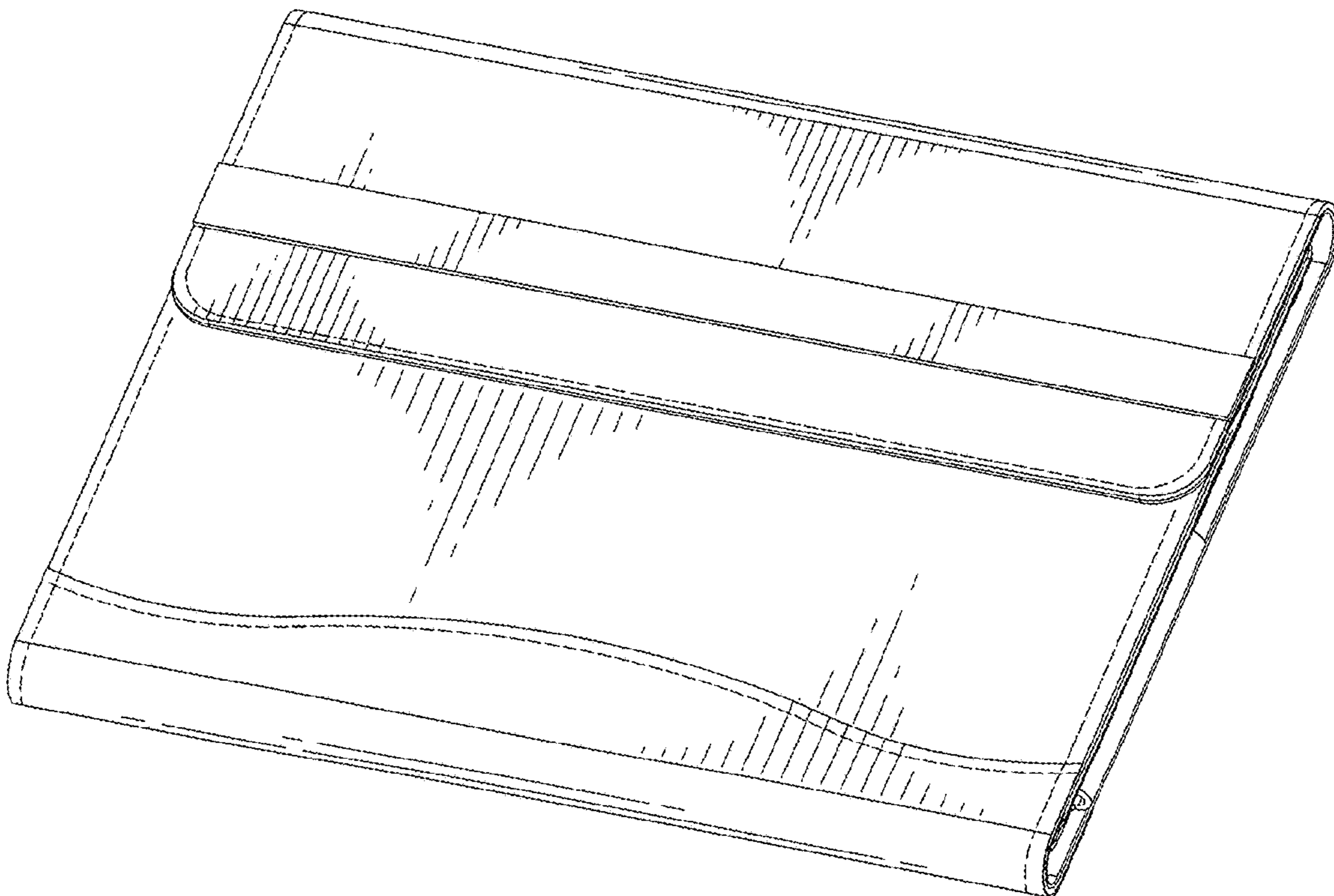

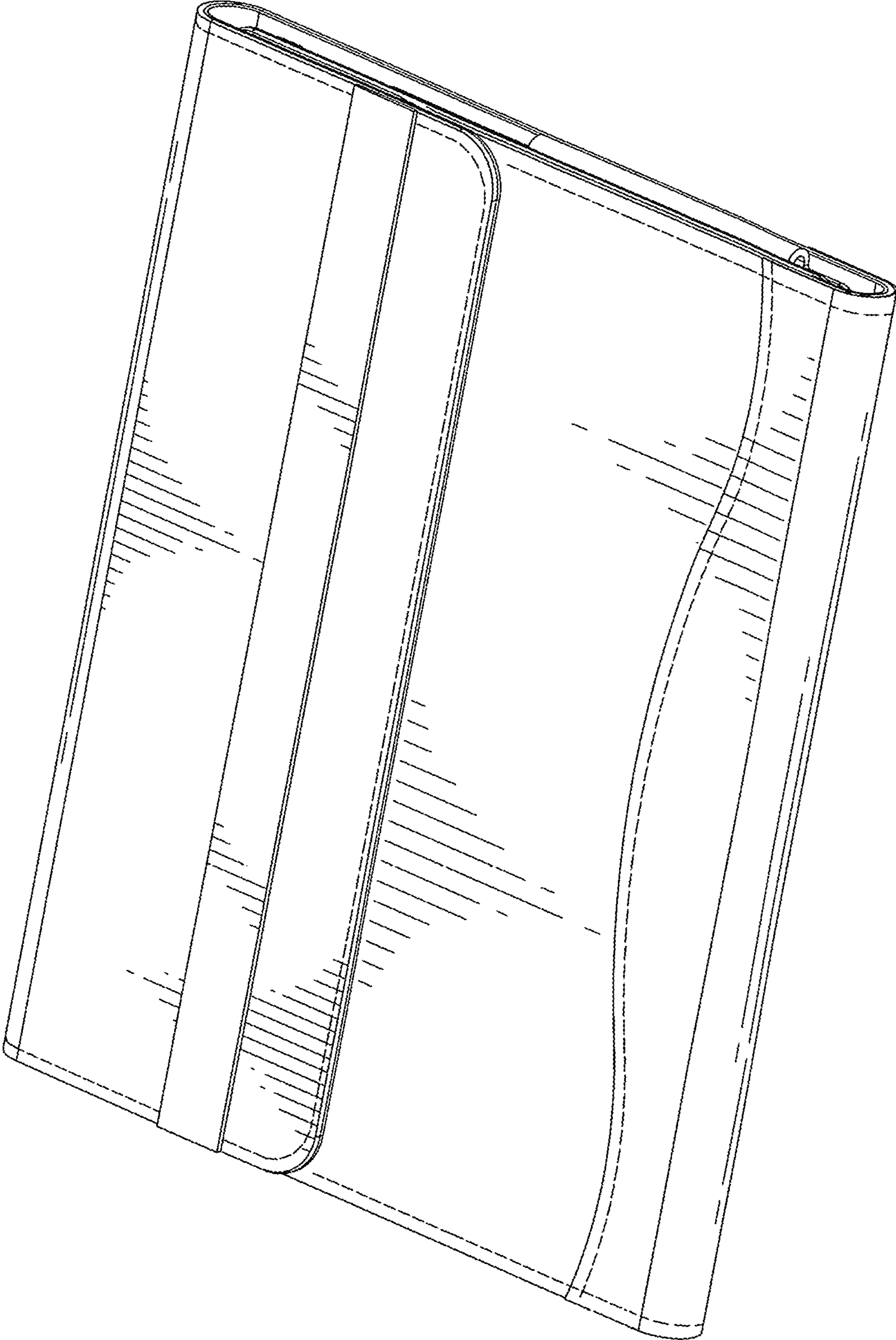

FIG. 1

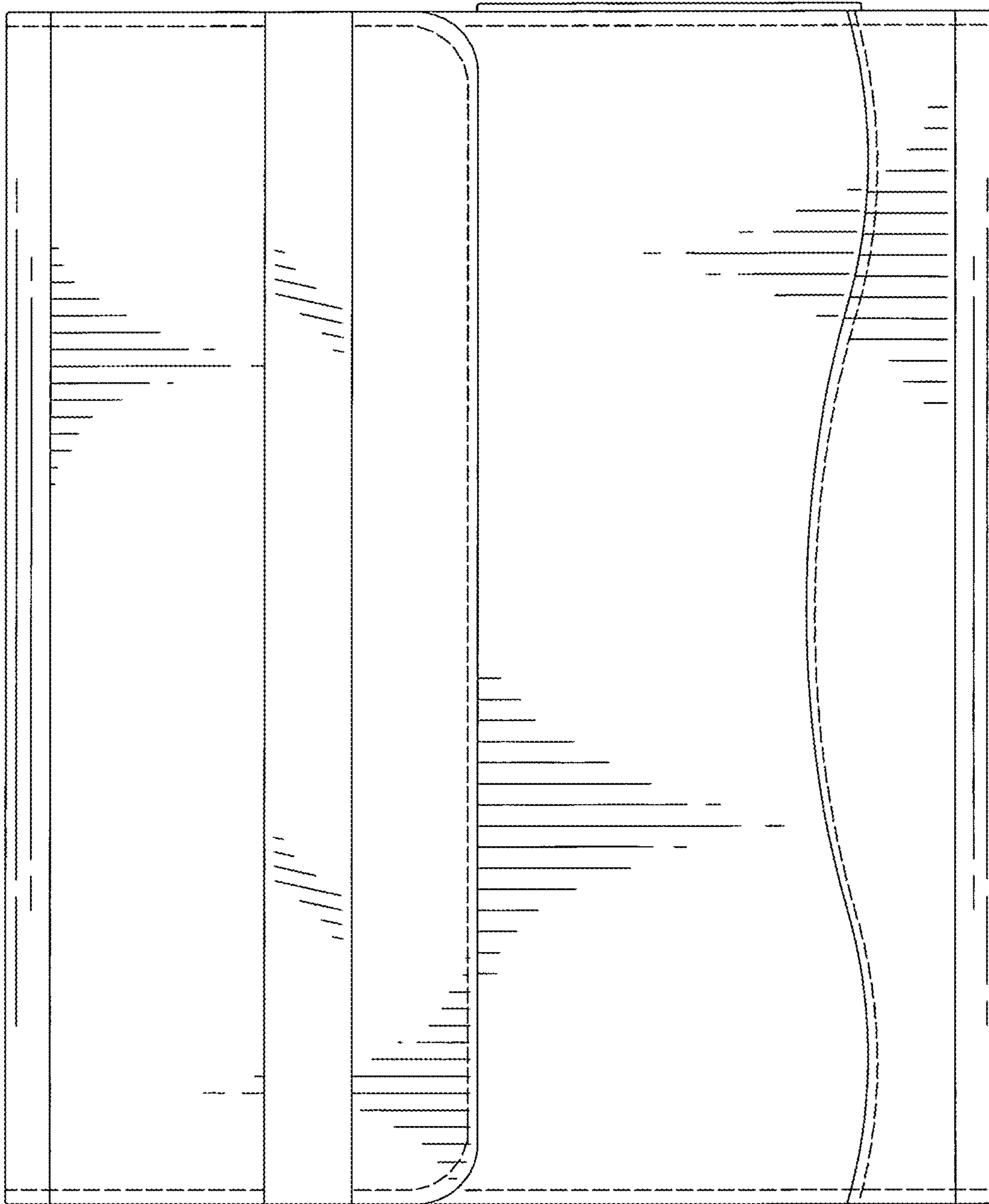

FIG. 2

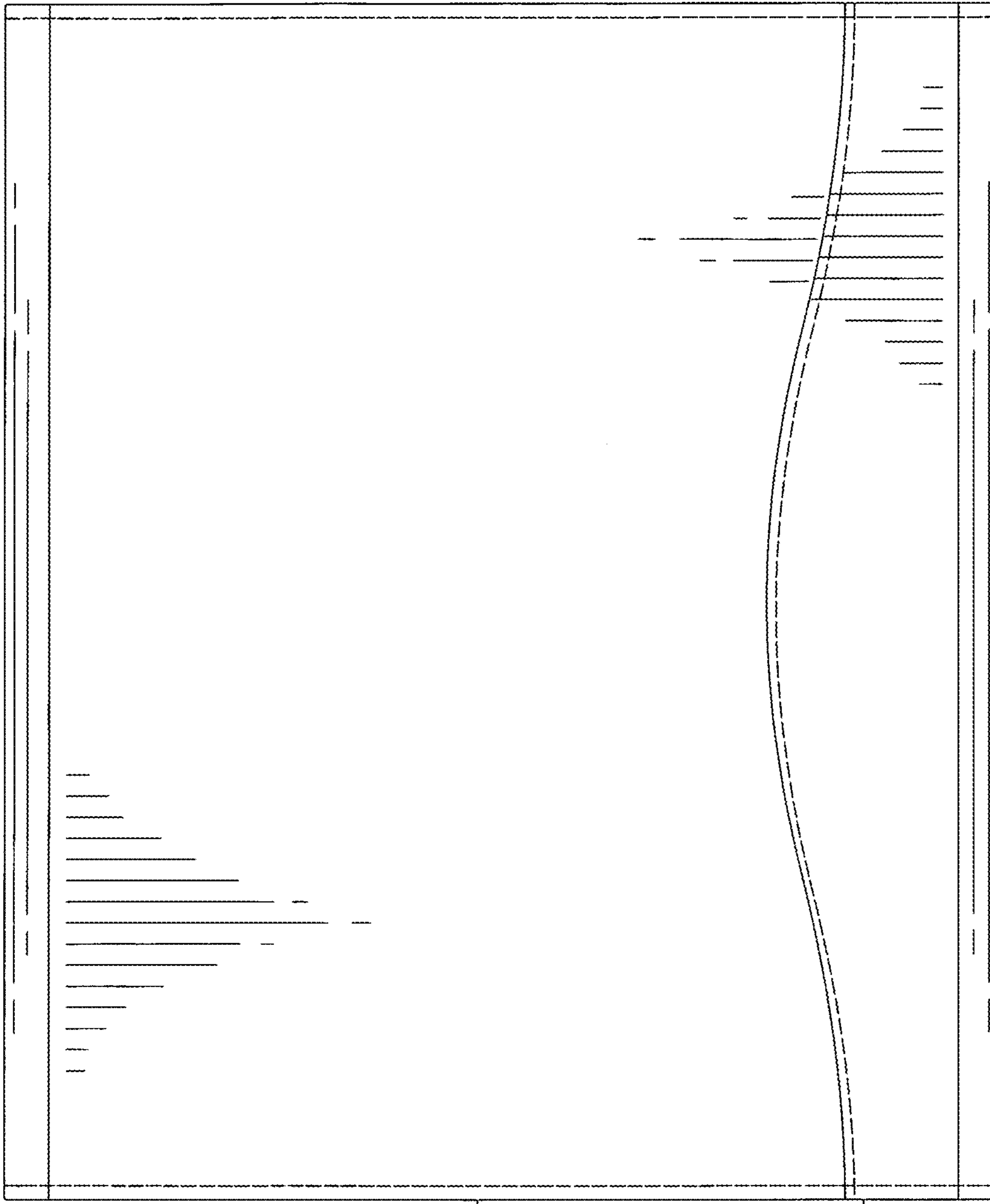

FIG. 3

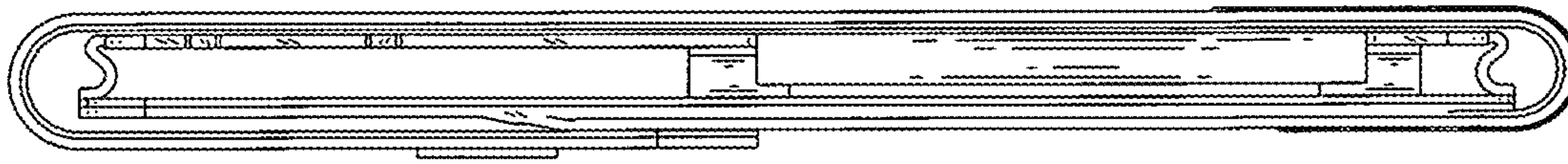

FIG. 5

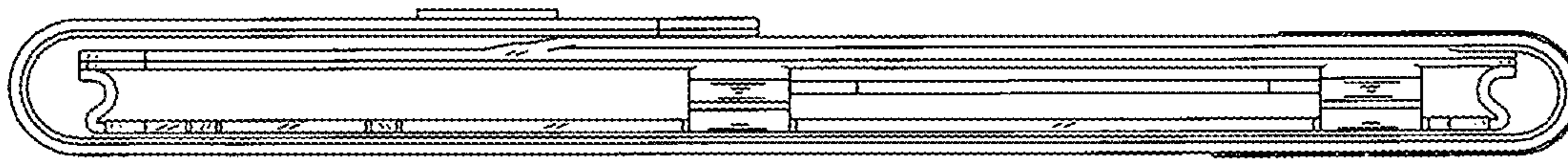

FIG. 4



FIG. 6

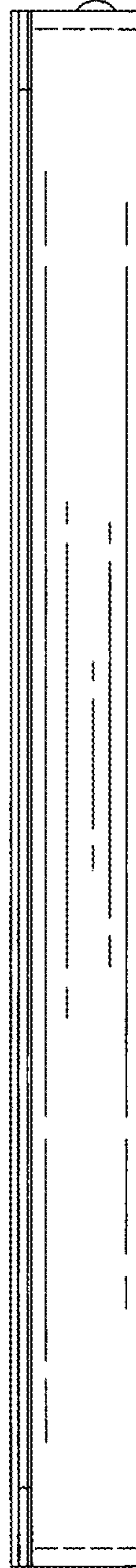

FIG. 7

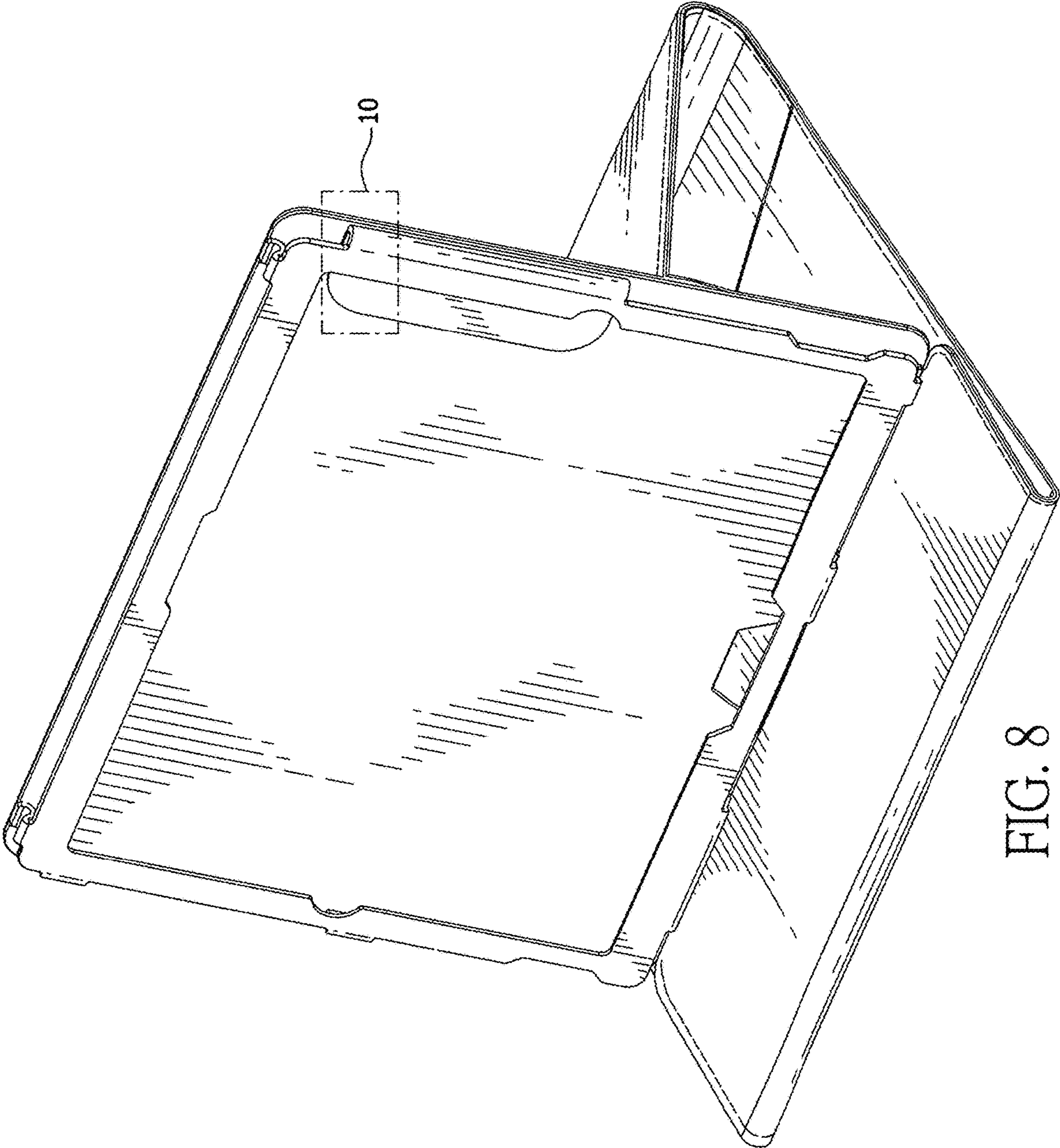

FIG. 8

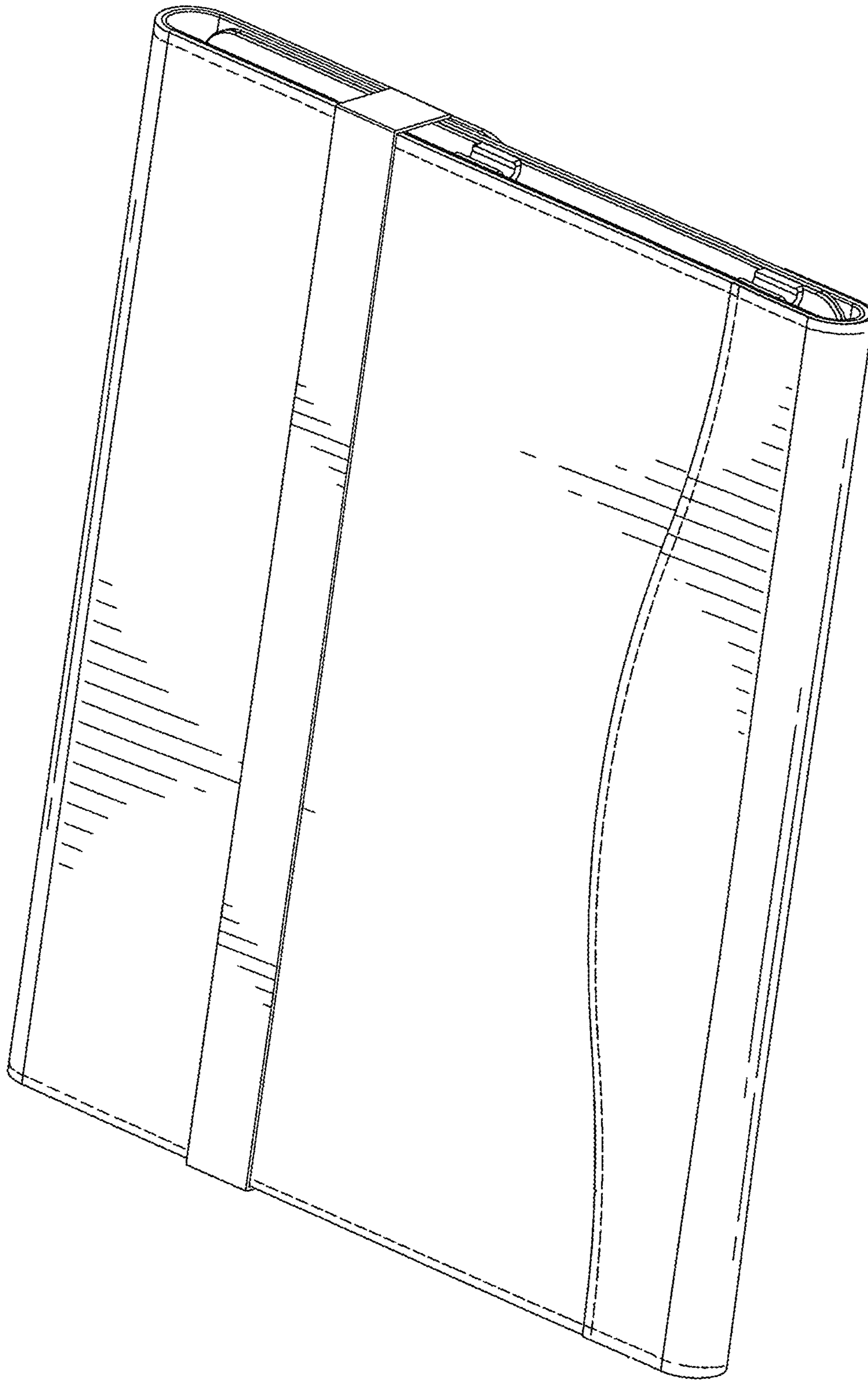

FIG. 9

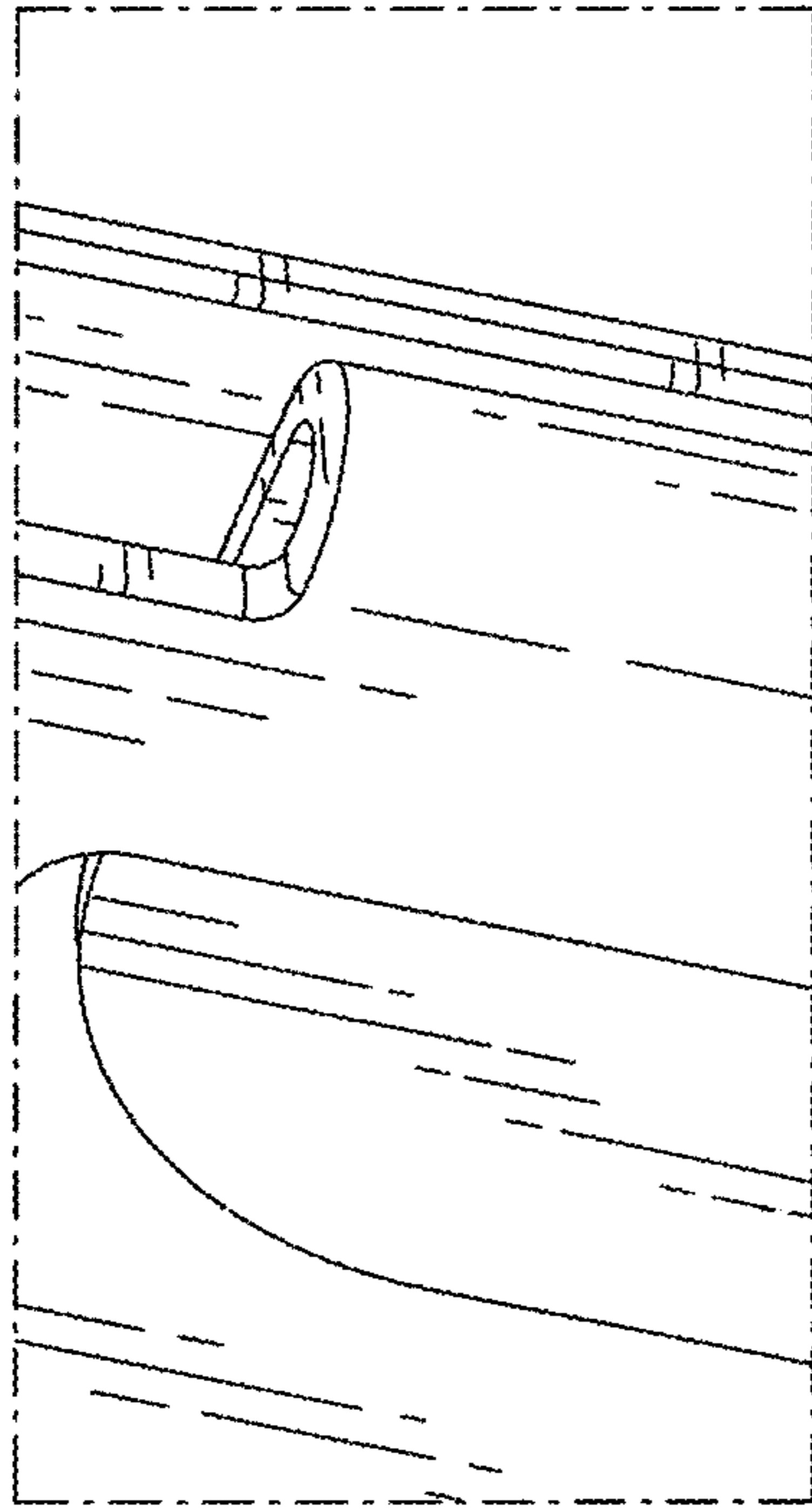

FIG. 10