



US00D890171S

(12) **United States Design Patent**
Wei et al.

(10) **Patent No.:** **US D890,171 S**
(45) **Date of Patent:** **** Jul. 14, 2020**

- (54) **DISPLAY DEVICE**
- (71) Applicant: **HTC Corporation**, Taoyuan (TW)
- (72) Inventors: **Chang-Hua Wei**, Taoyuan (TW);
Shih-Hsiu Lee, Taoyuan (TW);
Yu-Chuan Chang, Taoyuan (TW)
- (73) Assignee: **HTC CORPORATION**, Taoyuan (TW)
- (**) Term: **15 Years**
- (21) Appl. No.: **29/712,368**
- (22) Filed: **Nov. 7, 2019**

D819,636 S	6/2018	Chen et al.	
D822,659 S	7/2018	Spio	
D827,642 S	9/2018	Liu et al.	
D829,208 S	9/2018	Dallmeyer et al.	
D831,029 S	10/2018	Gu	
D834,018 S	* 11/2018	Wei	D14/372
D838,719 S	* 1/2019	Wei	D14/372
D839,871 S	* 2/2019	Wei	D14/372
D839,872 S	* 2/2019	Wei	D14/372
D856,330 S	* 8/2019	Wei	D14/372
D858,521 S	* 9/2019	Neil	D14/372
D860,200 S	9/2019	McGinty, Jr. et al.	
D862,469 S	* 10/2019	Sadot	D14/372

(Continued)

Primary Examiner — Austin Murphy

(74) *Attorney, Agent, or Firm* — Birch, Stewart, Kolasch & Birch, LLP

Related U.S. Application Data

- (62) Division of application No. 29/690,786, filed on May 10, 2019, now Pat. No. Des. 877,148, which is a division of application No. 29/631,267, filed on Dec. 28, 2017, now Pat. No. Des. 856,330.

- (51) **LOC (12) Cl.** **14-02**
- (52) **U.S. Cl.**
USPC **D14/372**

- (58) **Field of Classification Search**
USPC D14/372, 496, 432, 371, 125, 126, 129,
D14/299; D16/300–342; 351/158, 153,
351/144; 345/7–9, 905; 455/344;
348/115, 53, 121, 739
CPC G02B 27/017; G02B 27/0158; G02B
27/0161; G02B 27/0181; G02B 27/0185;
G02B 27/0189
See application file for complete search history.

(56) **References Cited**

U.S. PATENT DOCUMENTS

D810,743 S	2/2018	Yee et al.
D815,637 S	4/2018	Li
D819,634 S	6/2018	Pang et al.
D819,635 S	6/2018	Miller et al.

(57) **CLAIM**

The ornamental design for a display device, as shown and described.

DESCRIPTION

FIG. 1 is a top perspective view of a display device, such as a head mounted display, a virtual reality display, an augmented reality display, or a mixed reality display, in accordance with our new design;
 FIG. 2 is a front view thereof;
 FIG. 3 is a rear view thereof;
 FIG. 4 is a left view thereof;
 FIG. 5 is a right view thereof;
 FIG. 6 is a top plan view thereof;
 FIG. 7 is a bottom plan view thereof; and,
 FIG. 8 is a bottom perspective view thereof.
 The broken lines immediately adjacent the claimed areas represent the bounds of the claimed design while all other broken lines are directed to environment and are for illustrative purposes only. The broken lines form no part of the claimed design.

1 Claim, 6 Drawing Sheets

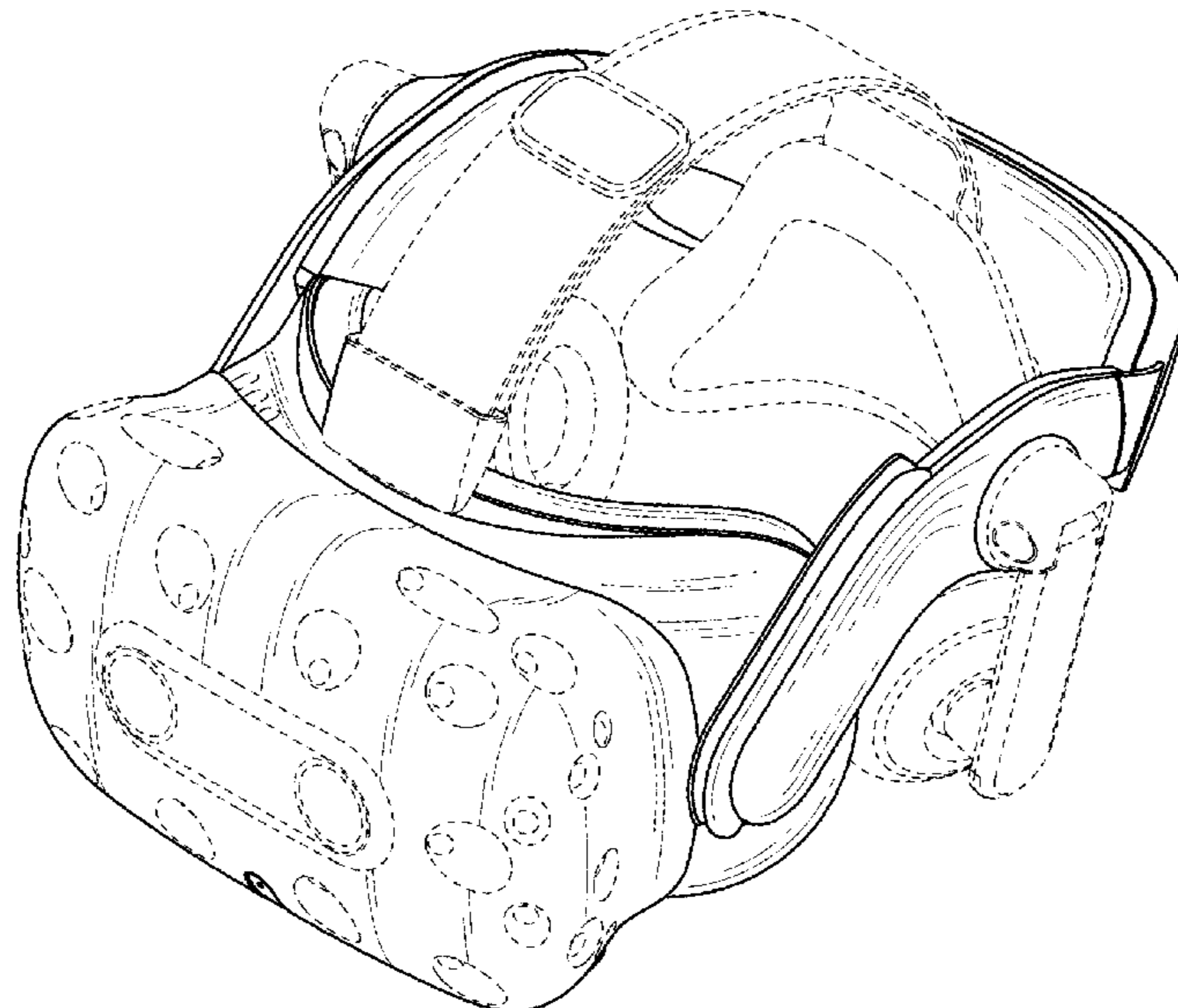

(56)

References Cited

U.S. PATENT DOCUMENTS

D863,300 S	*	10/2019	Boger	D14/372
D865,764 S	*	11/2019	Miller	D14/372
D875,094 S	*	2/2020	Miller	D14/372
D877,148 S	*	3/2020	Wei	D14/372

* cited by examiner

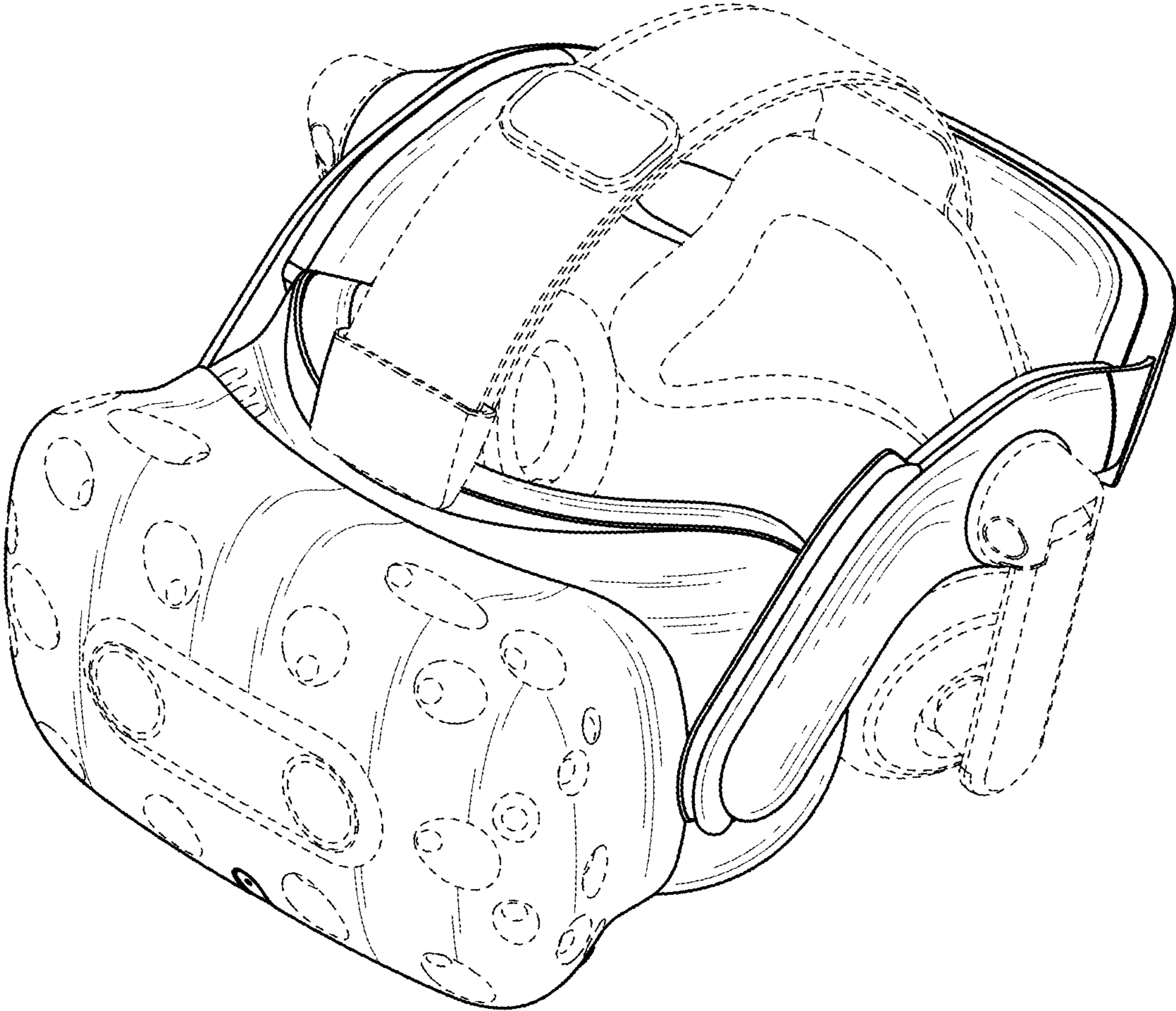

FIG. 1

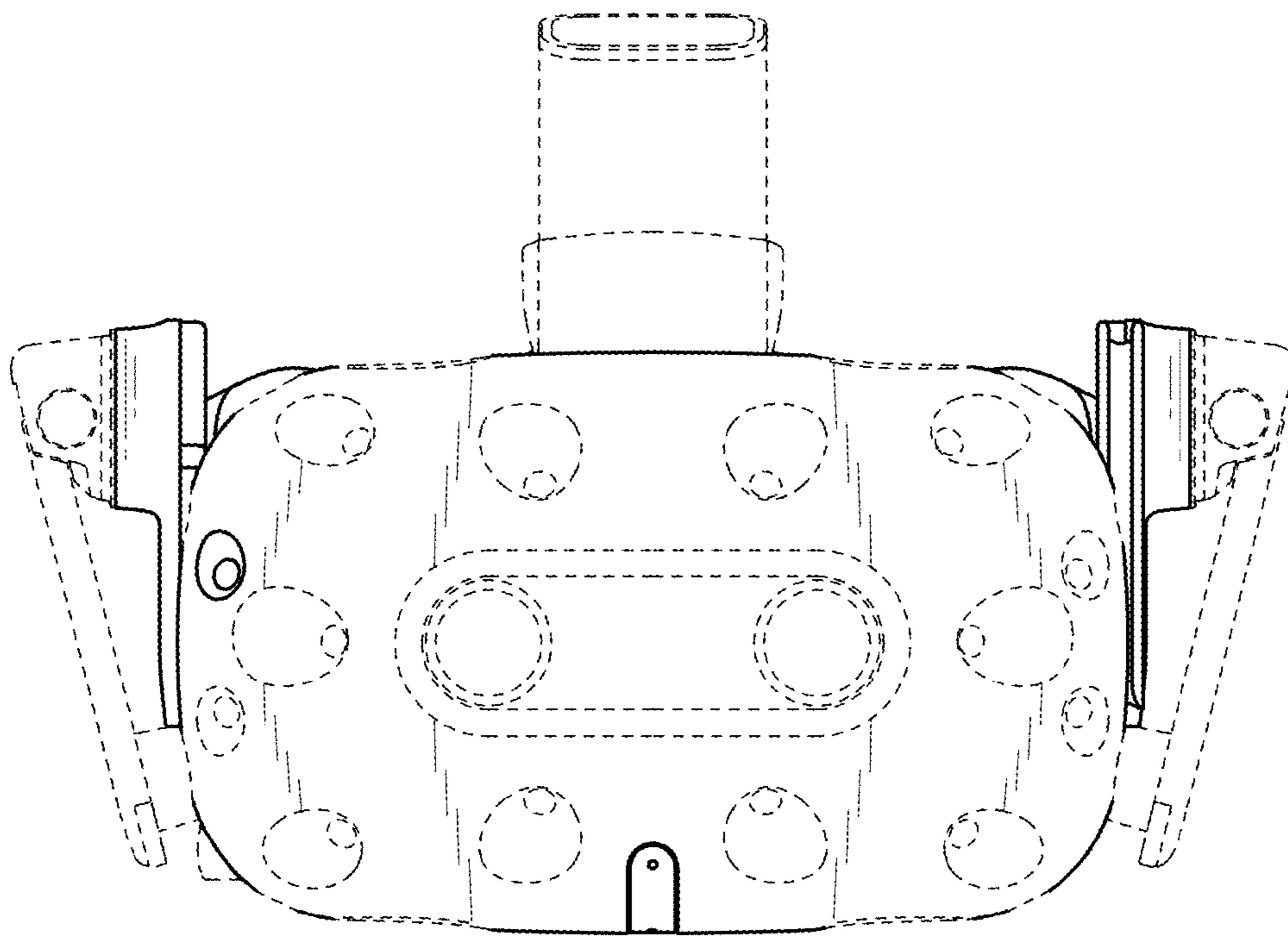

FIG. 2

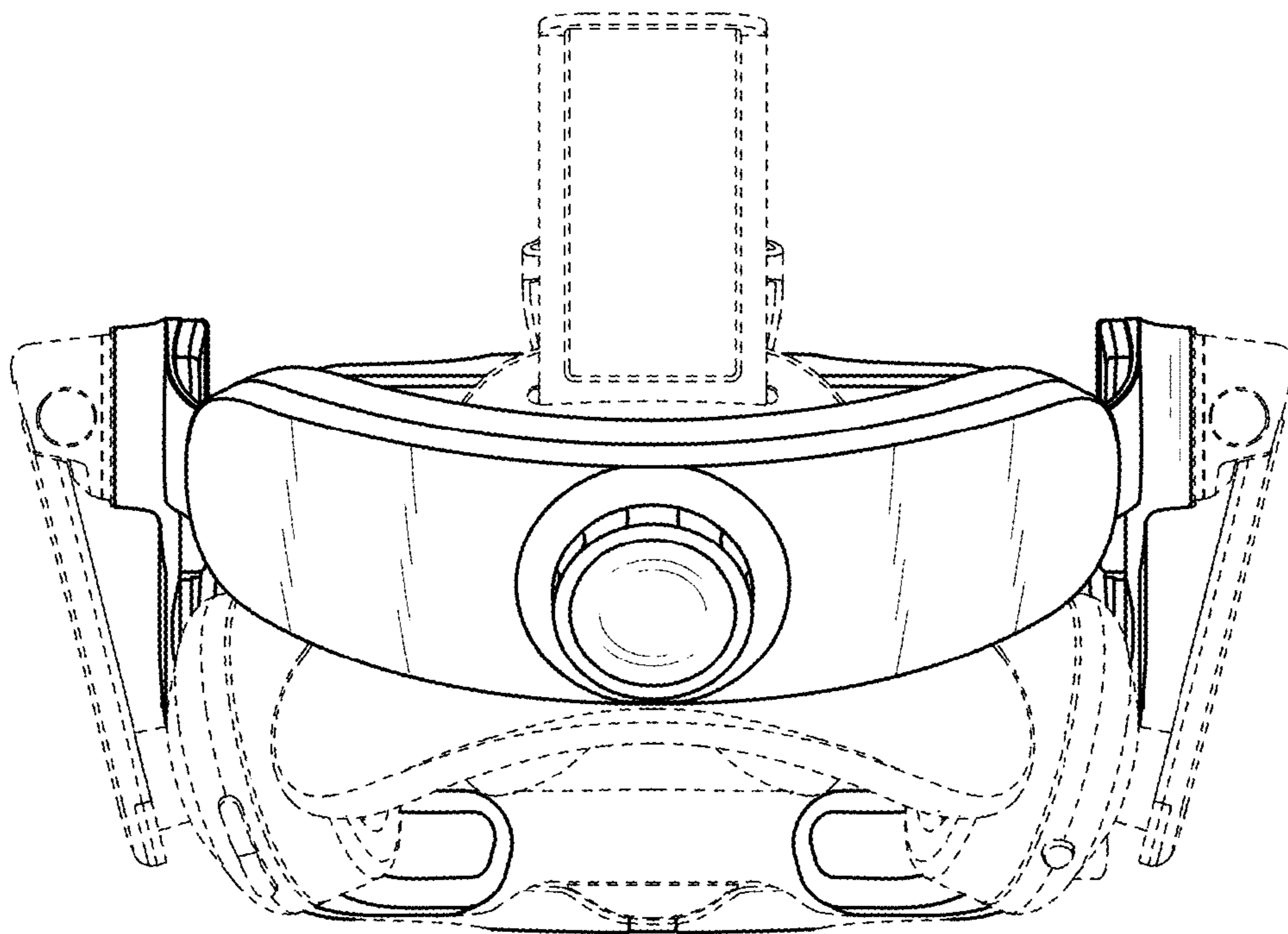

FIG. 3

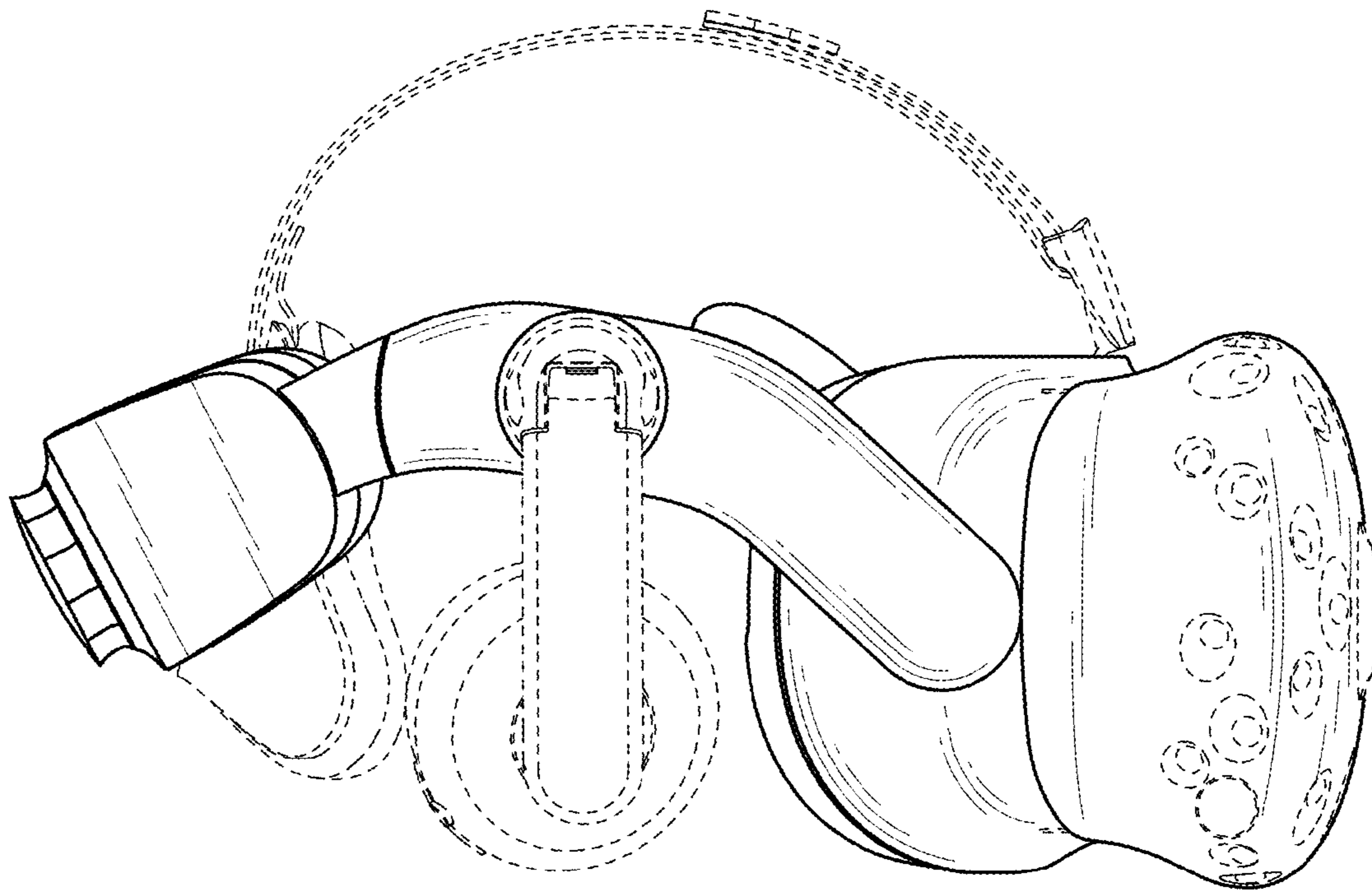

FIG. 4

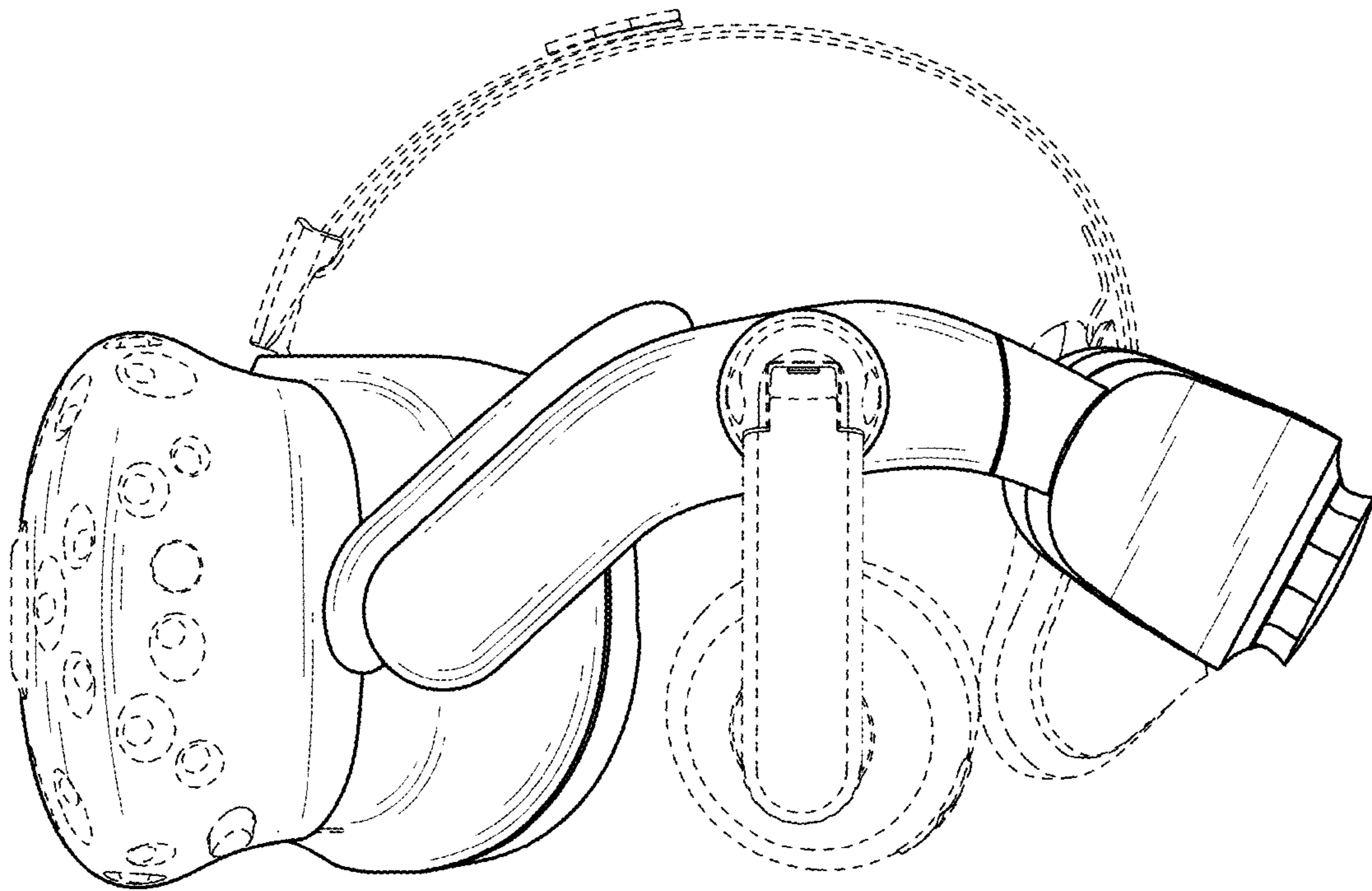

FIG. 5

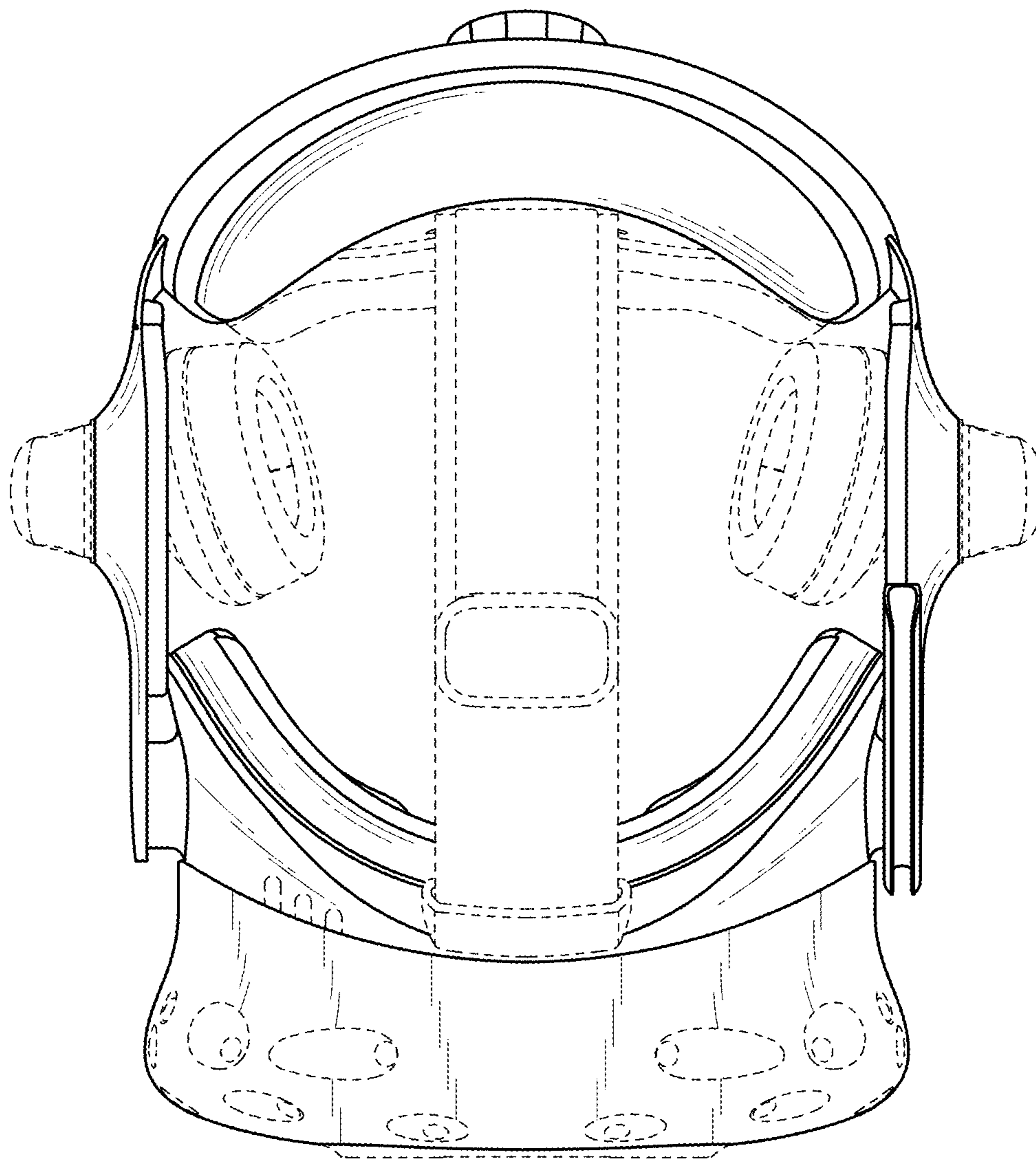

FIG. 6

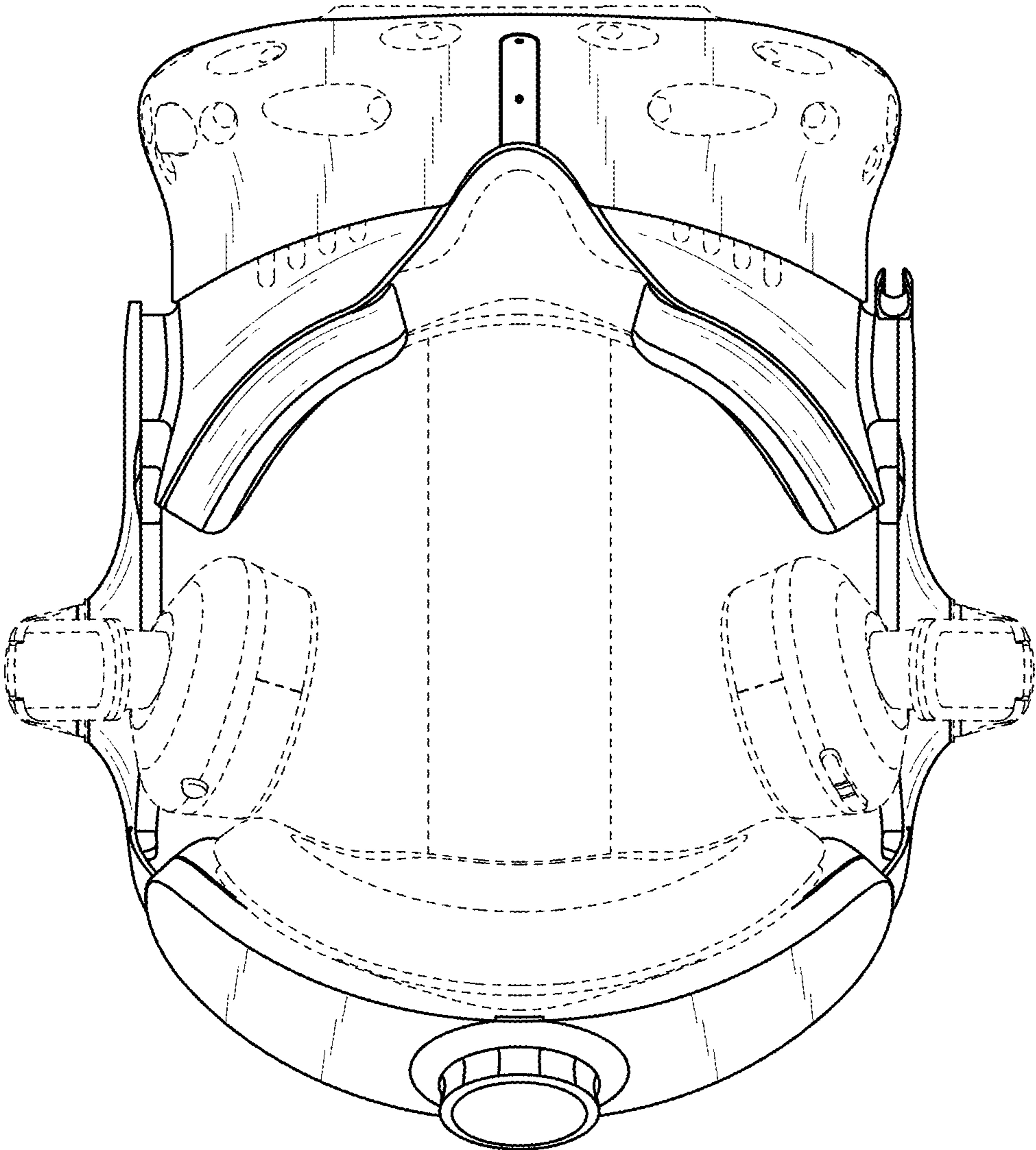

FIG. 7

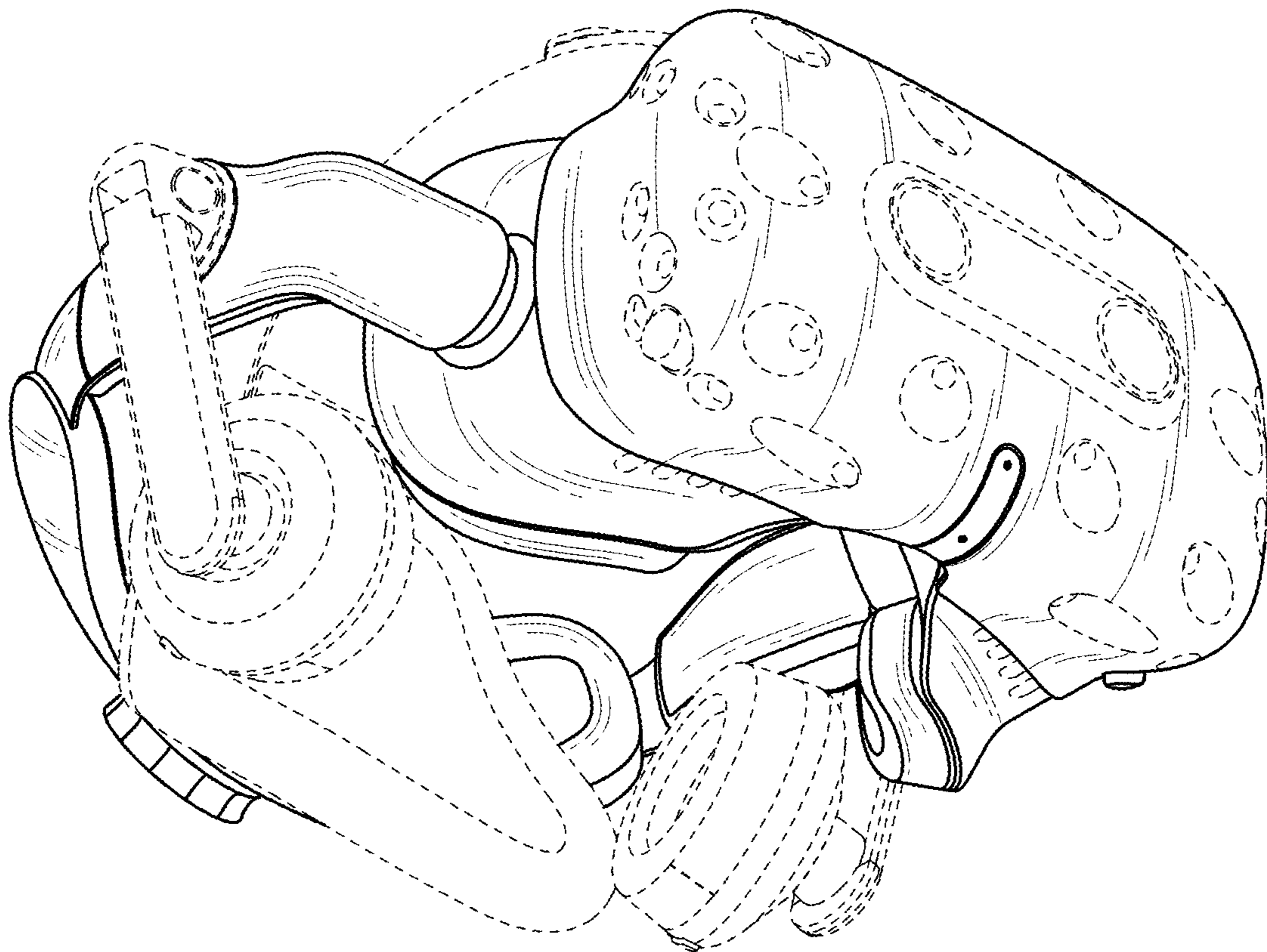

FIG. 8