



US00D890168S

(12) **United States Design Patent** (10) **Patent No.:** **US D890,168 S**
Akana et al. (45) **Date of Patent:** **** Jul. 14, 2020**

(54) **ELECTRONIC DEVICE**

(71) Applicant: **Apple Inc.**, Cupertino, CA (US)

(72) Inventors: **Jody Akana**, San Francisco, CA (US); **Molly Anderson**, San Francisco, CA (US); **Bartley K. Andre**, Palo Alto, CA (US); **Shota Aoyagi**, San Francisco, CA (US); **Anthony Michael Ashcroft**, San Francisco, CA (US); **Marine C. Bataille**, San Francisco, CA (US); **Jeremy Bataillou**, San Francisco, CA (US); **Daniele De Iulii**, San Francisco, CA (US); **Markus Diebel**, San Francisco, CA (US); **M. Evans Hankey**, San Francisco, CA (US); **Julian Hoenig**, San Francisco, CA (US); **Richard P. Howarth**, San Francisco, CA (US); **Jonathan P. Ive**, San Francisco, CA (US); **Julian Jaede**, San Francisco, CA (US); **Duncan Robert Kerr**, San Francisco, CA (US); **Peter Russell-Clarke**, San Francisco, CA (US); **Benjamin Andrew Shaffer**, San Jose, CA (US); **Mikael Silvanto**, San Francisco, CA (US); **Christopher J. Stringer**, Woodside, CA (US); **Joe Sung-Ho Tan**, San Francisco, CA (US); **Clement Tissandier**, San Francisco, CA (US); **Eugene Antony Whang**, San Francisco, CA (US); **Rico Zörkendörfer**, San Francisco, CA (US)

(73) Assignee: **Apple Inc.**, Cupertino, CA (US)

(**) Term: **15 Years**

(21) Appl. No.: **29/624,646**

(22) Filed: **Nov. 2, 2017**

Related U.S. Application Data

(63) Continuation of application No. 29/578,726, filed on Sep. 23, 2016, now Pat. No. Des. 806,700.

(51) **LOC (12) Cl.** 14-02

(52) **U.S. Cl.**
USPC **D14/318**

(58) **Field of Classification Search**
USPC D14/315-327, 333-335; D18/1, 2, 7, 11
CPC G06F 1/1601; G06F 1/1616; G06F 1/1618;
G06F 1/162; G06F 1/1681; H01R 35/02;
H05K 5/00; H05K 5/02; H05K 5/0226;
H04M 1/00; H04M 1/2479; H04M
1/72519; H04M 11/066; H04M 2201/38
See application file for complete search history.

(56) **References Cited**

U.S. PATENT DOCUMENTS

D264,969 S	6/1982	McGourty
4,976,435 A	12/1990	Shatford et al.
5,192,082 A	3/1993	Inoue et al.
D345,346 S	3/1994	Alfonso et al.
D349,923 S	8/1994	Billings et al.
D359,306 S	6/1995	Lande et al.
D362,272 S	9/1995	Luong
D362,461 S	9/1995	Luong
D378,686 S	4/1997	Proctor et al.
5,661,632 A	8/1997	Register
D385,299 S	10/1997	Adams
D386,521 S	11/1997	Eisenbaum
5,694,292 A	12/1997	Paulsel et al.
5,694,294 A	12/1997	Ohashi et al.
5,713,790 A	2/1998	Lin
D391,927 S	3/1998	Faranda et al.
D396,452 S	7/1998	Naruki
5,793,355 A	8/1998	Youens
D399,526 S	10/1998	Brady
D402,310 S	12/1998	Hendricks
D410,028 S	5/1999	Fyffe
D412,940 S	8/1999	Kato et al.
5,964,661 A	10/1999	Dodge
D416,238 S	11/1999	Irie et al.
6,038,128 A	3/2000	Hood et al.
D425,558 S	5/2000	Tarpenning et al.
D425,874 S	5/2000	Tanimura
6,067,224 A	5/2000	Nobuchi
D430,117 S	8/2000	Sachs et al.
D430,169 S	8/2000	Scibora
D431,821 S	10/2000	Mizuno
6,166,737 A	12/2000	Lee et al.
D437,860 S	2/2001	Suzuki et al.
D445,787 S	7/2001	Francis
6,254,477 B1	7/2001	Sasaki et al.

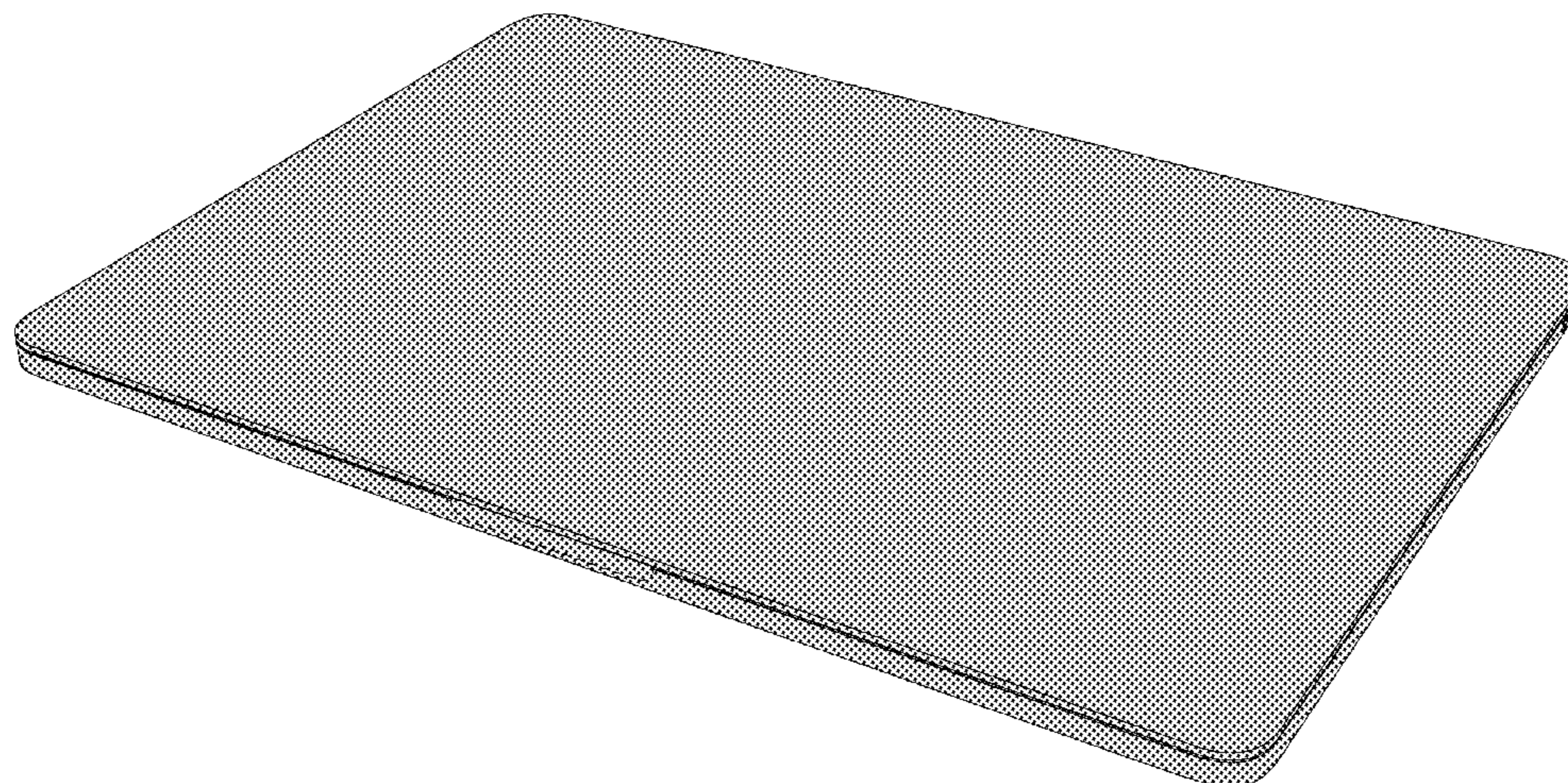

US D890,168 S

D448,810 S	10/2001	Goto		D621,409 S	8/2010	Andre et al.	
D449,606 S	10/2001	Lee et al.		D621,825 S	8/2010	Andre et al.	
D450,713 S	11/2001	Matsamitsu et al.		D622,268 S	8/2010	Hong et al.	
D451,505 S	12/2001	Iseki et al.		D623,645 S	9/2010	Andre et al.	
D452,250 S	12/2001	Chan		D625,716 S	10/2010	Andre et al.	
D453,333 S	2/2002	Chen		D625,717 S	10/2010	Andre et al.	
D458,252 S	6/2002	Palm et al.		D633,087 S *	2/2011	Andre	D14/315
D463,797 S	10/2002	Andre et al.		D633,488 S	3/2011	Kim et al.	
D469,109 S	1/2003	Andre et al.		D633,907 S	3/2011	Andre et al.	
D472,245 S	3/2003	Andre et al.		D635,566 S	4/2011	Andre et al.	
D481,036 S	10/2003	Wentt		7,948,752 B2	5/2011	Tatsukami et al.	
6,657,854 B2	12/2003	Horii et al.		D639,295 S	6/2011	Andre et al.	
D486,823 S	2/2004	Kuo		D642,172 S	7/2011	Akana et al.	
D487,457 S	3/2004	Liu		D642,560 S	8/2011	Akana et al.	
D487,742 S	3/2004	Huang et al.		D648,333 S	11/2011	Andre et al.	
D489,717 S	5/2004	Hsieh		D648,334 S	11/2011	Andre et al.	
D490,420 S	5/2004	Solomon et al.		D652,032 S	1/2012	Akana et al.	
D491,177 S	6/2004	Andre et al.		D654,072 S	2/2012	Andre et al.	
D491,933 S	6/2004	Guo		D655,704 S	3/2012	Akana et al.	
D491,936 S	6/2004	Jao		8,139,352 B2	3/2012	Yamamoto et al.	
6,744,623 B2	6/2004	Numano et al.		D657,786 S	4/2012	Andre et al.	
D493,785 S	8/2004	Andre et al.		8,170,266 B2 *	5/2012	Hopkinson	H04R 1/023 361/679.01
D494,164 S	8/2004	Wu et al.					
6,771,494 B2	8/2004	Shimano		D661,296 S	6/2012	Akana et al.	
D497,618 S	10/2004	Andre et al.		D662,497 S	6/2012	Akana et al.	
D501,472 S	2/2005	Kumano		D664,537 S	7/2012	Hu et al.	
D501,660 S	2/2005	Kumano		8,223,487 B2	7/2012	Chen et al.	
6,876,546 B2	4/2005	Tsao		8,238,090 B2	8/2012	Watanabe	
D504,889 S	5/2005	Andre et al.		8,339,775 B2	12/2012	Degner et al.	
6,932,525 B2	8/2005	Trotman		D674,382 S	1/2013	Andre et al.	
D512,997 S	12/2005	Lee et al.		D676,437 S	2/2013	Akana et al.	
6,972,946 B2	12/2005	Hamada et al.		D676,438 S *	2/2013	Akana	D14/318
D513,509 S	1/2006	Kawa		D679,704 S	4/2013	McManigal et al.	
D517,063 S	3/2006	Nakajima et al.		D679,705 S	4/2013	McManigal et al.	
7,012,802 B2	3/2006	Nakajima et al.		D682,821 S	5/2013	Kim et al.	
7,035,665 B2	4/2006	Kido et al.		D682,824 S *	5/2013	Kim	D14/315
D523,429 S	6/2006	Lin		D685,784 S	7/2013	Ma	
D524,306 S	7/2006	Yun et al.		D686,202 S *	7/2013	Lee	D14/315
D526,999 S	8/2006	Tago		D686,205 S *	7/2013	Akana	D14/318
D527,730 S	9/2006	Dong		D686,611 S *	7/2013	Lin	D14/315
D529,907 S	10/2006	Dong		D687,030 S	7/2013	Andre et al.	
D533,550 S	12/2006	Yamada		D687,031 S	7/2013	Chen et al.	
D547,310 S	7/2007	Yoon		D691,128 S	10/2013	Akana et al.	
D556,192 S	11/2007	Jeong et al.		D691,129 S	10/2013	Akana et al.	
D558,752 S	1/2008	Andre et al.		D694,748 S	12/2013	Okuley et al.	
D558,753 S	1/2008	Andre et al.		D696,244 S	12/2013	Akana et al.	
D571,364 S	6/2008	Andre et al.		D696,569 S	12/2013	Chen et al.	
D572,246 S	7/2008	Andre et al.		D696,660 S	12/2013	Chen et al.	
D572,247 S	7/2008	Andre et al.		D696,661 S	12/2013	Chen et al.	
D574,378 S	8/2008	Andre et al.		8,616,748 B1 *	12/2013	Degner	G06F 1/1616 361/679.02
7,426,113 B2	9/2008	Ikeno et al.					
D581,411 S	11/2008	Kumano		8,687,359 B2	4/2014	Thobald et al.	
D589,507 S	3/2009	Andre et al.		8,734,036 B2	5/2014	Hirsch	
D600,688 S	9/2009	Andre et al.		D706,759 S	6/2014	Myung et al.	
D601,556 S	10/2009	Iseki		D706,772 S	6/2014	Koyama et al.	
D603,861 S	11/2009	Hong et al.		8,742,275 B1 *	6/2014	Lam	H01H 13/705 200/516
D604,289 S	11/2009	Andre et al.					
D604,290 S	11/2009	Andre et al.		D708,176 S	7/2014	Akana et al.	
D604,291 S *	11/2009	Andre	D14/315	D708,179 S	7/2014	Andre et al.	
D604,292 S	11/2009	Andre et al.		D710,841 S *	8/2014	Akana	D14/318
D604,293 S	11/2009	Andre et al.		D717,787 S	11/2014	Jung et al.	
D604,294 S	11/2009	Andre et al.		D719,149 S	12/2014	Matsuoka	
D606,068 S	12/2009	Hong et al.		8,947,874 B2	2/2015	Andre et al.	
D606,534 S	12/2009	Hong et al.		D723,539 S *	3/2015	Andre	D14/315
D606,988 S	12/2009	Andre et al.		D729,227 S	5/2015	Fukuoka	
D606,989 S	12/2009	Andre et al.		D741,316 S	10/2015	Andre et al.	
D607,450 S	1/2010	Morishita et al.		D768,619 S *	10/2016	Akana	D14/315
7,660,104 B2	2/2010	Ligtenberg		D776,107 S	1/2017	Akana et al.	
D611,043 S	3/2010	Andre et al.		D787,500 S *	5/2017	Akana	D14/315
D611,044 S	3/2010	Andre et al.		D803,825 S *	11/2017	Akana	D14/315
D611,045 S	3/2010	Andre et al.		D806,701 S *	1/2018	Akana	D14/315
D611,469 S	3/2010	Andre et al.		D816,661 S *	5/2018	Akana	D14/315
D612,843 S	3/2010	Andre et al.					
D613,284 S	4/2010	Solomon et al.		2005/0008418 A1	1/2005	Green	
D616,488 S	6/2010	Andre et al.		2005/0180794 A1	8/2005	Parkinson	
D616,880 S	6/2010	Andre et al.		2005/0207817 A1	9/2005	Jenkins	
D616,881 S	6/2010	Andre et al.		2006/0147239 A1	7/2006	Kuriss	
D617,789 S	6/2010	Akana et al.		2006/0257191 A1	11/2006	Artus	
7,733,636 B2	6/2010	Kobayashi et al.		2008/0074833 A1	3/2008	Chien et al.	
				2010/0067182 A1	3/2010	Tanaka et al.	

2010/0091442 A1 4/2010 Theobald et al.
 2011/0255727 A1 10/2011 Azuchi
 2012/0099263 A1 4/2012 Lin

FOREIGN PATENT DOCUMENTS

CN	301384975	11/2010
JP	1128620	12/2001
JP	1438161	4/2012
JP	1469539	5/2013
KR	30-0608518-0000	8/2011
KR	30-0613298-0000	9/2011
KR	30-0687340-0000	4/2013

OTHER PUBLICATIONS

Sony X505, available at least as early as May 8, 2005.
 HP Compaq Tablet PC Tc 1100, http://web.archive.org/web/20040726084509/h_18000.www1.hp.com/products/tabletpc/, downloaded Aug. 27, 2004.
 Tablet PC V1100, <http://web.archive.org/web/20040714060448/www.viewsonic.com/products/desktopdisplays/tabletpc/tabletpcv1100/>, downloaded Aug. 27, 2004.
 VIA Tablet PC Reference Design: The Digital Notepad, <http://www.via.com/en/initiatives/spearhead/information-pc/>, downloaded Aug. 27, 2004.
 ViewPad 1000, http://www.viewsonic.com/support/mobilewireless/tabletpc/viewpad1000_index.htm, downloaded Aug. 27, 2004.
 Photographs of Sony VAIO PCG-4G1L, available at least as early as May 8, 2006.
 Apple PowerBook G4 Titanium, available at least as early as Jan. 1, 2001.
 Apple PowerBook G4 Aluminum, available at least as early as Jan. 1, 2003.
 Apple MacBook Pro, available at least as early as Jan. 10, 2006.
 Apple MacBook Air, available Jan. 15, 2008, http://images.apple.com/macbookair/images/design_gal01_20080115.jpg.
 Apple MacBook Air, available Jan. 15, 2008, http://images.apple.com/macbookair/images/design_gal02_20080115.jpg.
 Apple MacBook Air, available Jan. 15, 2008, http://images.apple.com/macbookair/images/design_gal03_20080115.jpg.
 Apple MacBook Air, available Jan. 15, 2008, http://images.apple.com/macbookair/images/design_gal04_20080115.jpg.
 Apple MacBook Air, available Jan. 15, 2008, http://images.apple.com/macbookair/images/design_thinair20080115.jpg.
 Apple MacBook Air, available Jan. 15, 2008, http://images.apple.com/macbookair/images/design_displayair20080115.jpg.
 Apple MacBook Air, available Jan. 15, 2008, http://images.apple.com/macbookair/images/design_keyboardair20080115.jpg.
 Apple MacBook Air, available Jan. 15, 2008, http://images.apple.com/macbookair/images/design_gal08_20080115.jpg.
 Appendix in U.S. Appl. No. 29/201,636, entitled "Electronic Device", filed Mar. 17, 2004, now U.S. Pat No. D. 504,889.
 Olidata Altro, available at least as early as Jun. 1, 2009.
 Olidata Altro, <http://notebookitalia.it/olidata-altro-italian-style-notebook-culv-5674.html>, published Mar. 3, 2009.
 Rudi, 13-inch MacBook Air has a modern interior, Nov. 2, 2011, prohardver, 2pgs.
 Sharp Corporation, Sharp Releases Notebook PC with Optical Sensor LCD Pad, "Mebius", <http://www.sharp.co.jp/corporate/news/090421-a.html>, available as early as Apr. 21, 2009.

Designboom, Lenovo Yoga 3 Pro Laptop's Flexible-Use Stabilized by Watchband Hinge, <http://www.designboom.com/technology/lenovo-yoga-3-pro-laptop-10-10-2014/>, available as early as Oct. 10, 2014.

Mark Gurman, Apple's next major Mac revealed: the radically new 12-inch MacBook Air, <https://9to5mac.com/2015/01/06/macbook-air-12-inch-redesign/>, available as early as Jan. 6, 2015.

Best Buy Co., Inc., <http://www.bestbuy.com/site/olspage.jsp?id=cat13506&type=page&skuId=9441909&productId=1218105184065&navigation=next&count=1&chk=true&h=387>, available as early as Sep. 4, 2009.

17-inch Apple MacBook Pro Review, http://www.laptopmag.com/uploadedimages/review/laptops/2009/apple/macbook_pro_2561g.jpg, available as early as Feb. 25, 2009.

* cited by examiner

Primary Examiner — Sandra S Snapp
Assistant Examiner — Katherine Glennon
 (74) *Attorney, Agent, or Firm* — Saidman DesignLaw Group, LLC

(57) **CLAIM**

The ornamental design for an electronic device, as shown and described.

DESCRIPTION

FIG. 1 is a closed top front perspective view of an electronic device showing our new design;
 FIG. 2 is a closed bottom rear perspective view thereof;
 FIG. 3 is a closed front view thereof;
 FIG. 4 is a closed rear view thereof;
 FIG. 5 is a closed left side view thereof;
 FIG. 6 is a closed right side view thereof;
 FIG. 7 is a closed top view thereof;
 FIG. 8 is a closed bottom view thereof;
 FIG. 9 is an open top front perspective view thereof;
 FIG. 10 is an open bottom rear perspective view thereof;
 FIG. 11 is an open front view thereof;
 FIG. 12 is an open rear view thereof;
 FIG. 13 is an open left side view thereof;
 FIG. 14 is an open right side view thereof;
 FIG. 15 is an open top view thereof;
 FIG. 16 is an open bottom view thereof; and,
 FIG. 17 is an enlargement of FIG. 15.

The oblique shade lines illustrate a transparent surface. The dark gray shading illustrates a contrast in appearance to the light gray shading. Shading does not represent any particular color, material, or finish. The black areas illustrate the color black.

The broken lines illustrate structure or features which form no part of the claimed design.

1 Claim, 14 Drawing Sheets

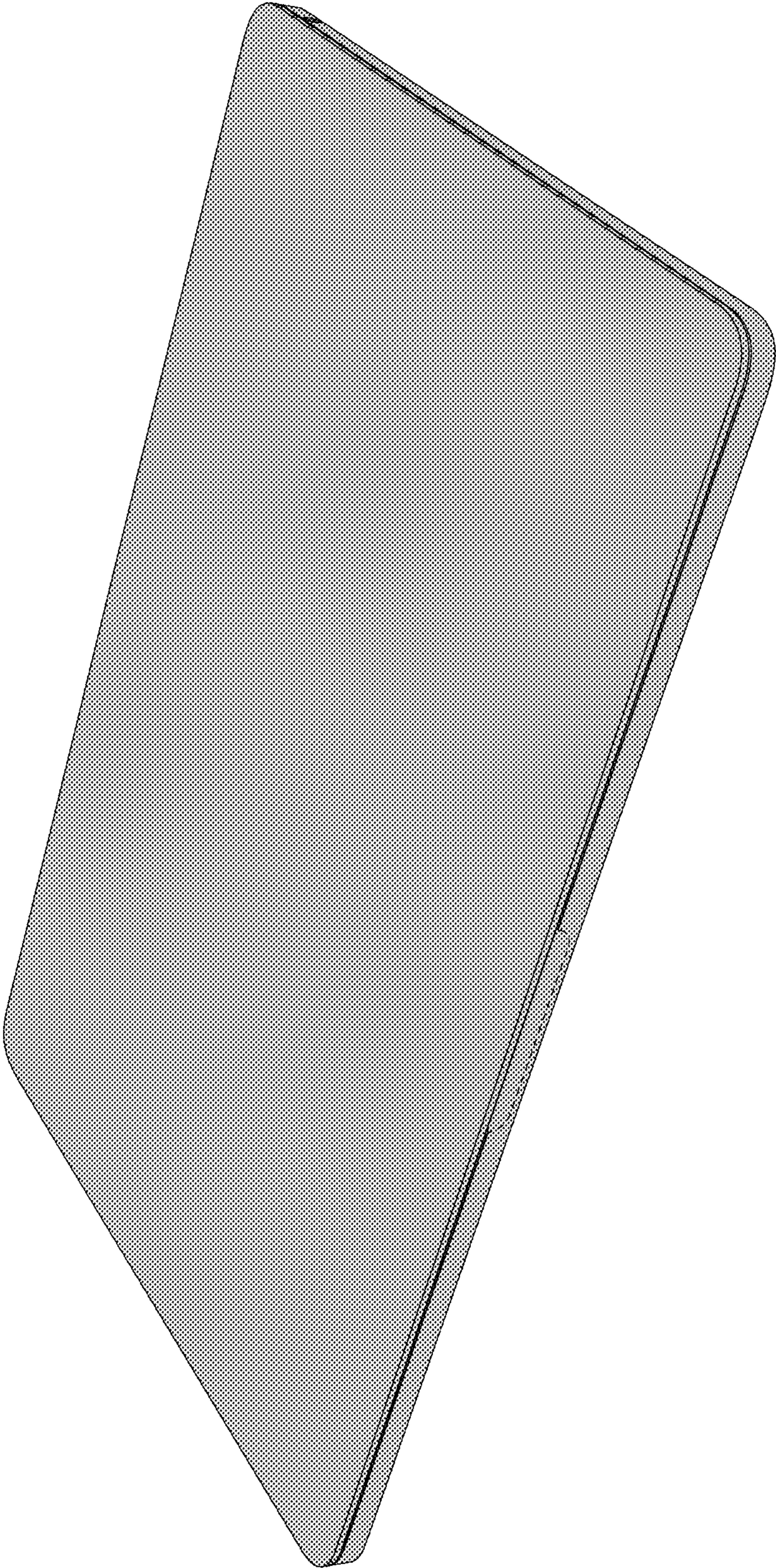

FIG. 1

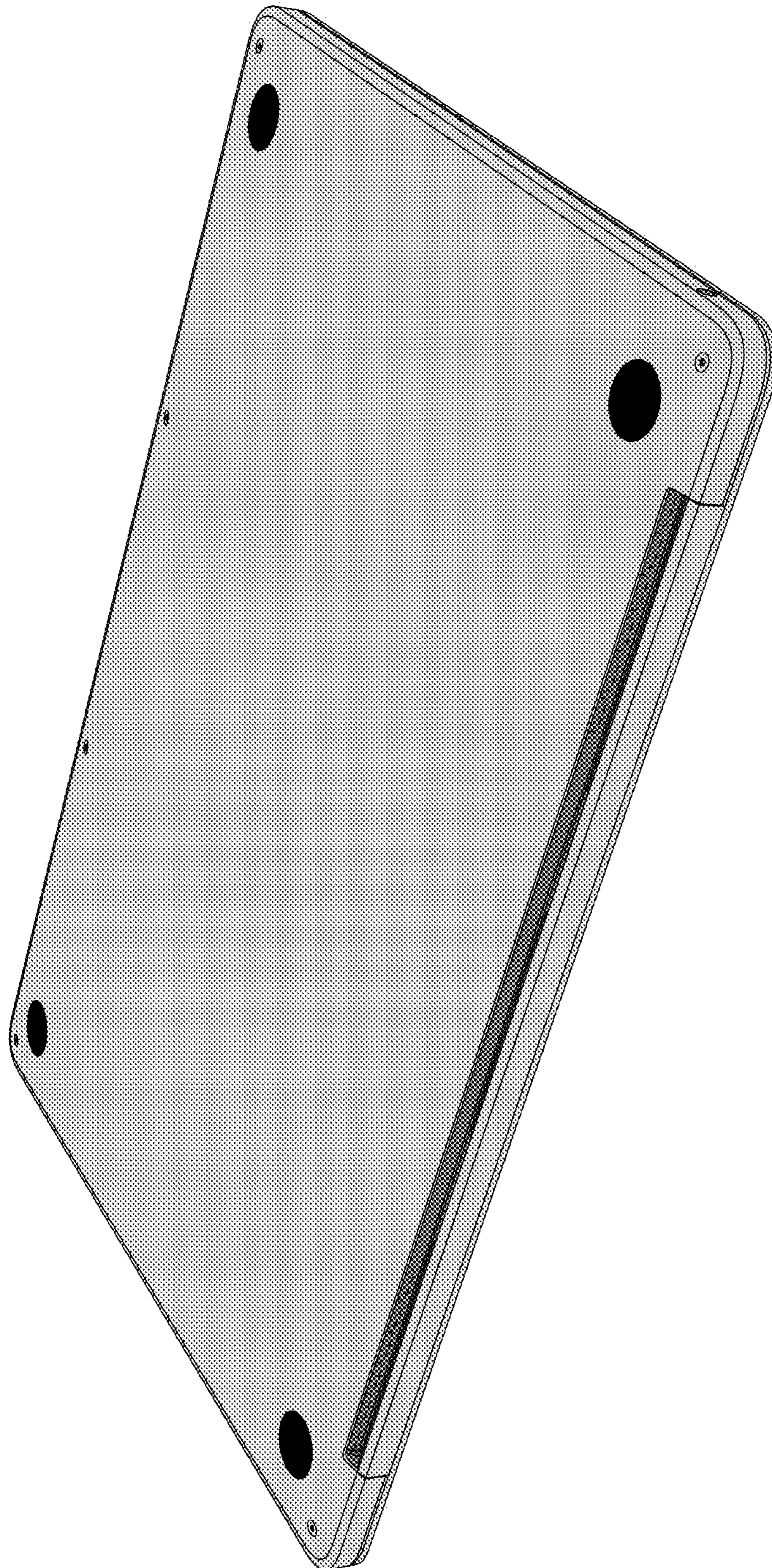

FIG. 2

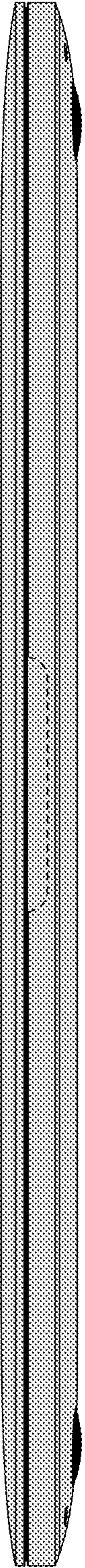

FIG. 3

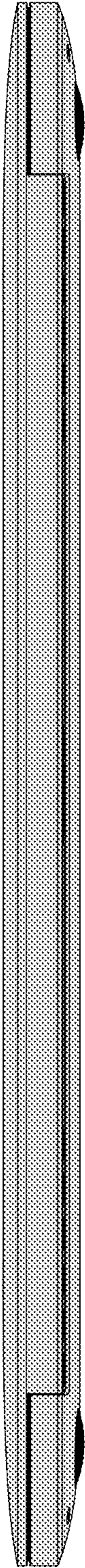

FIG. 4

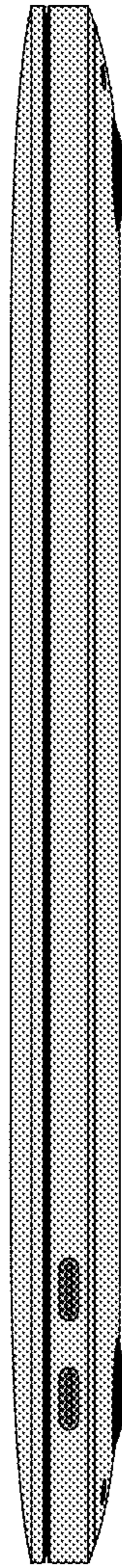

FIG. 5

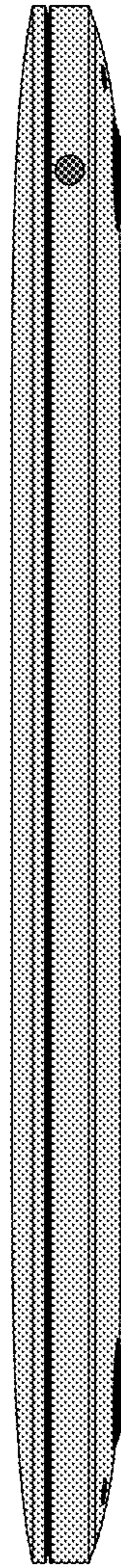

FIG. 6

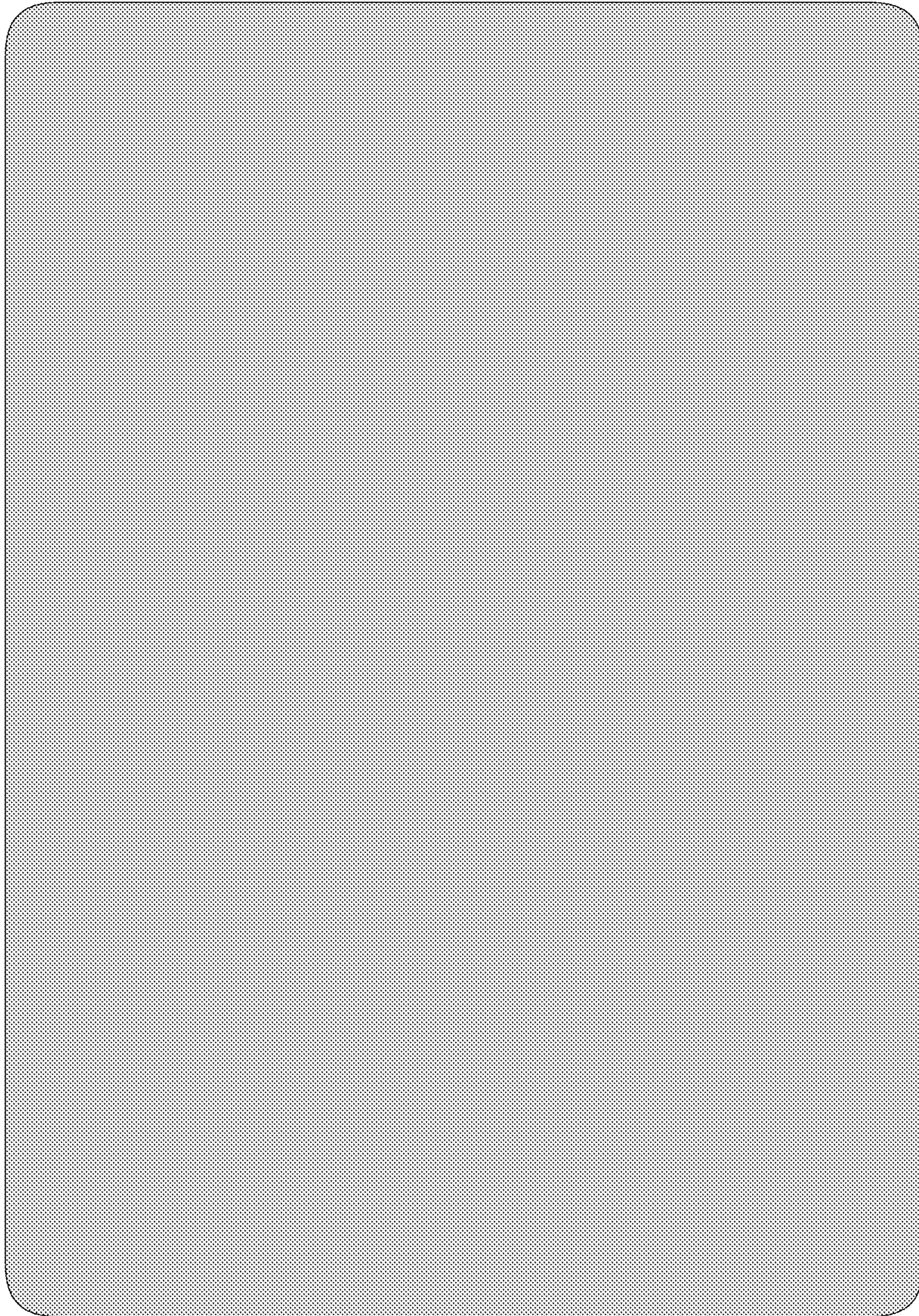

FIG. 7

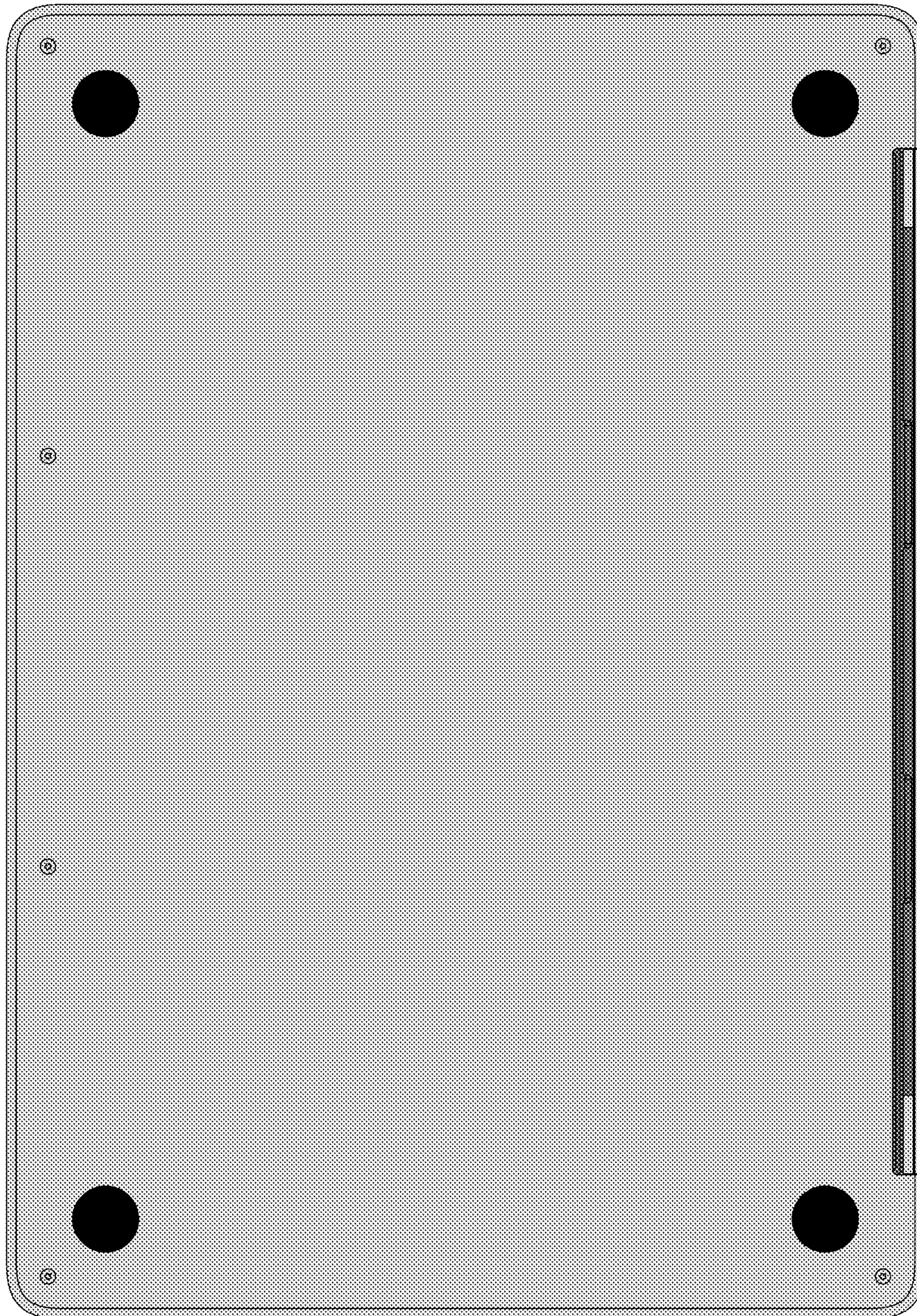

FIG. 8

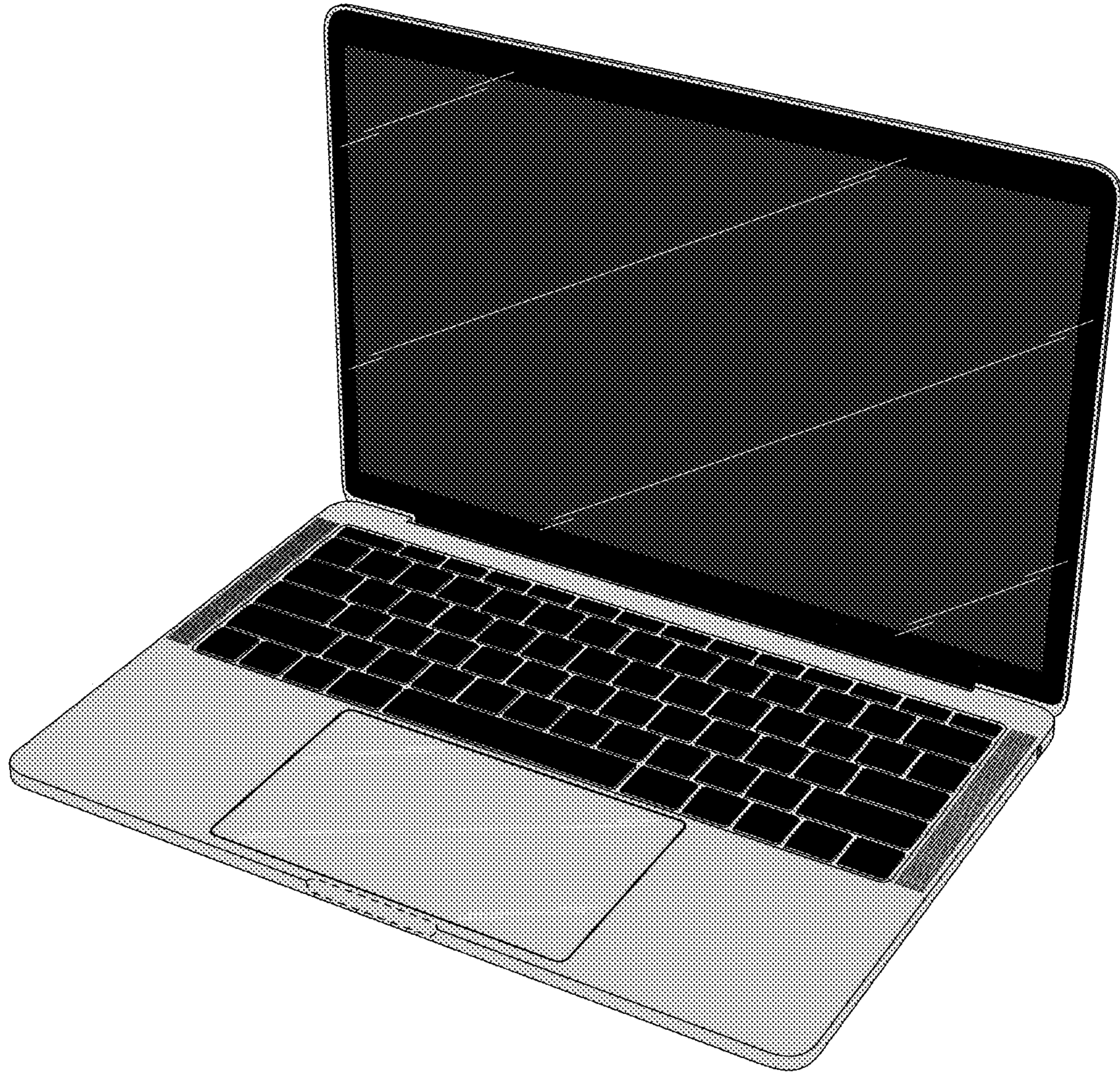

FIG. 9

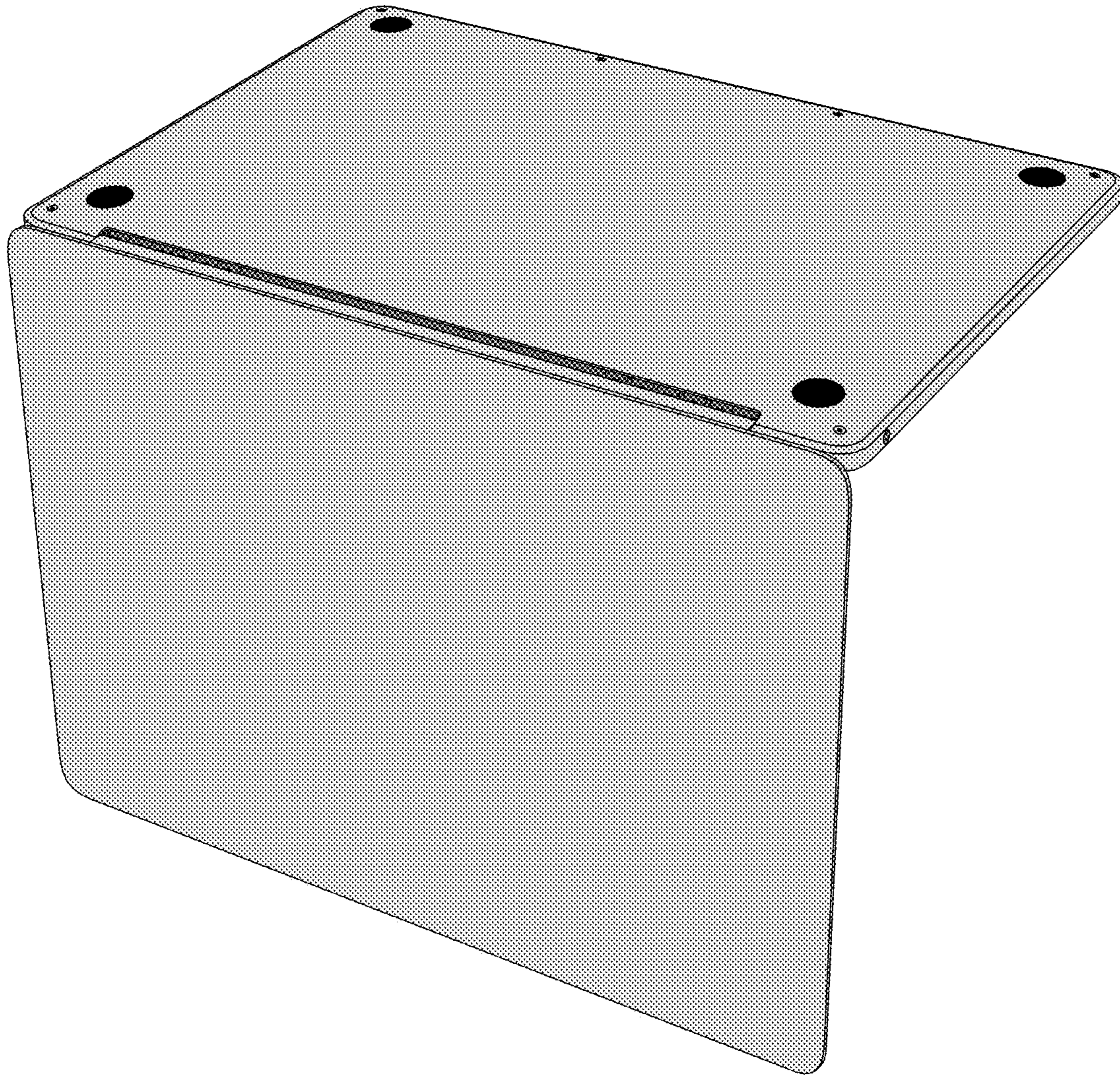

FIG. 10

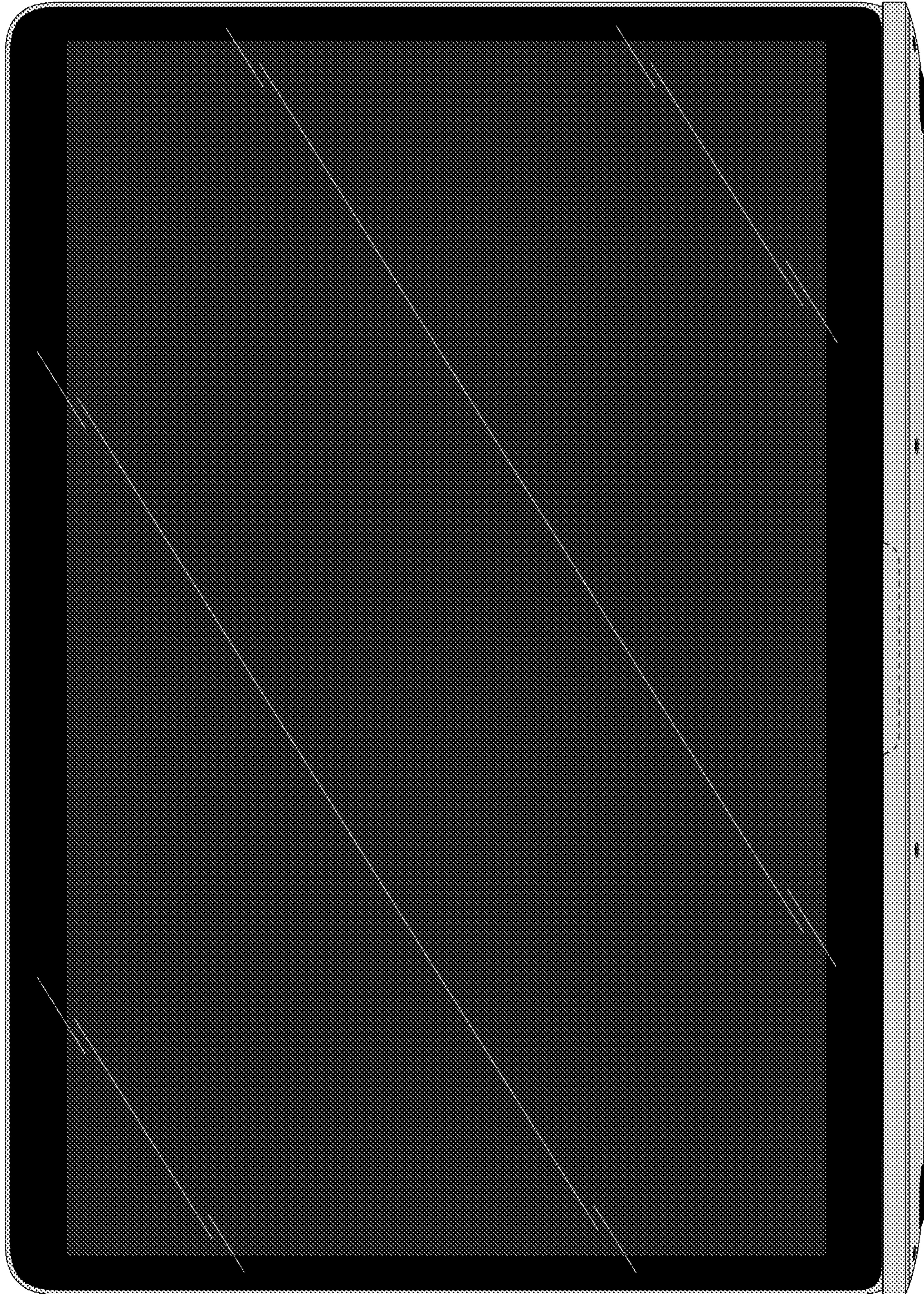

FIG. 11

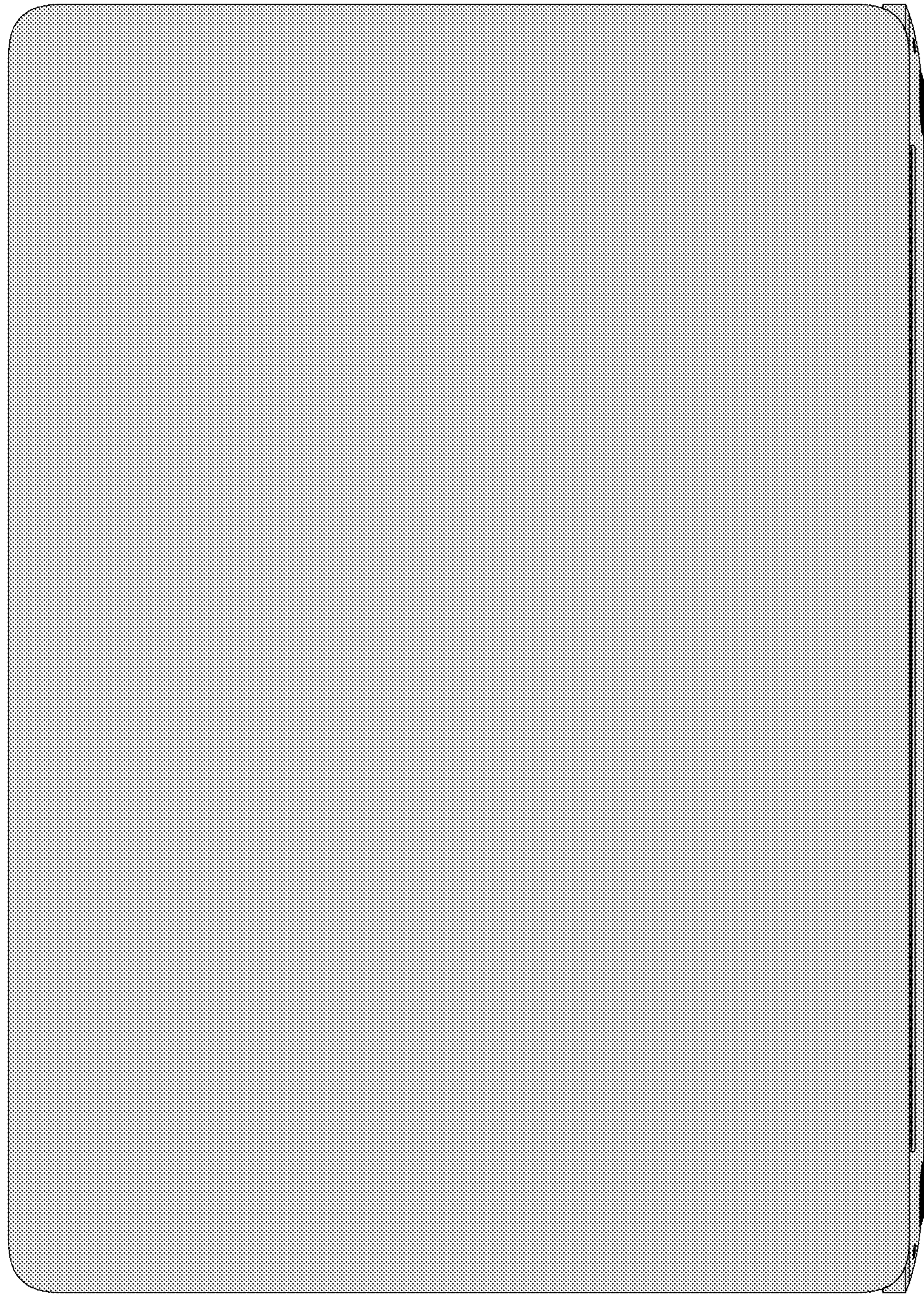

FIG. 12

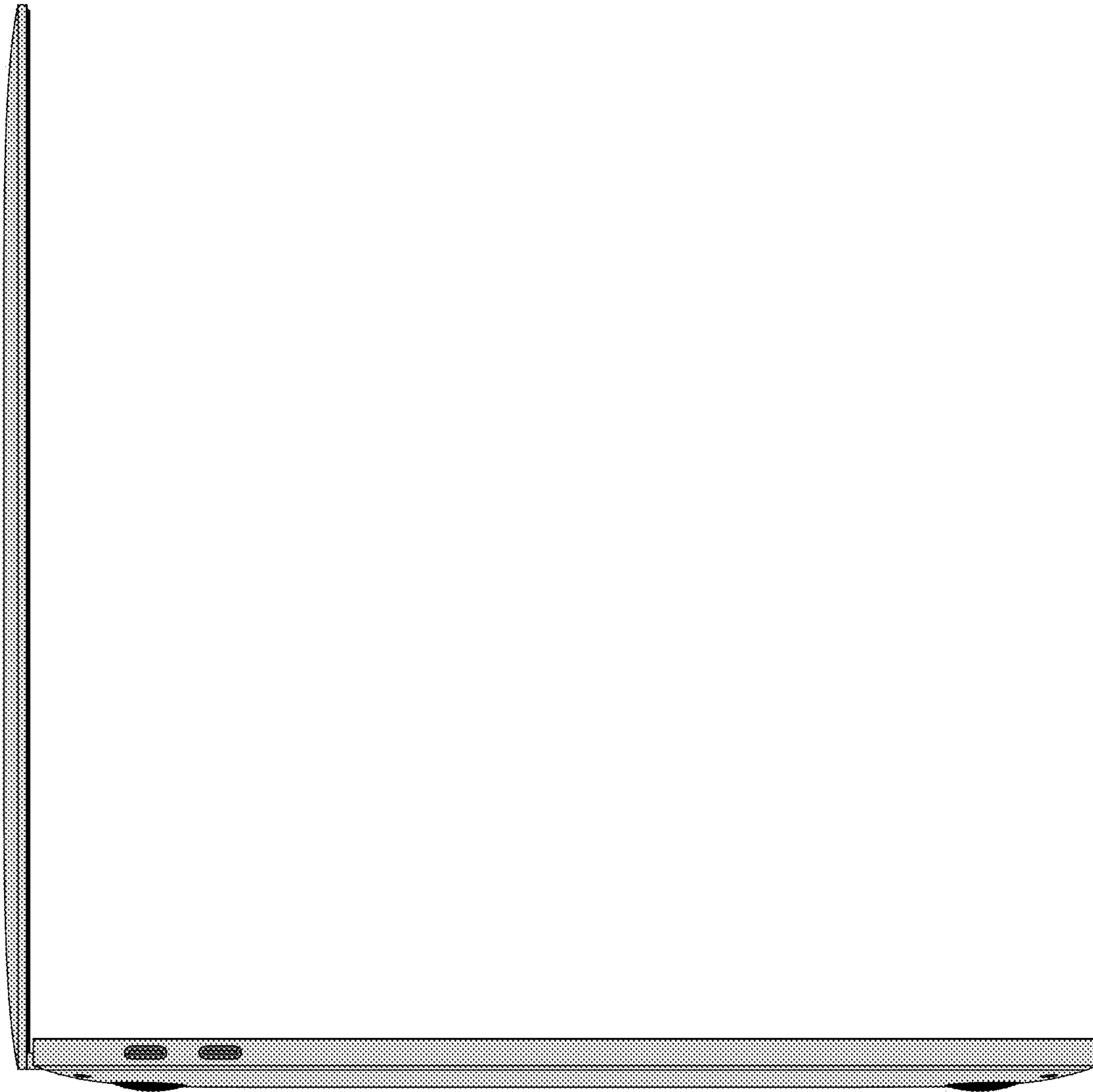

FIG. 13

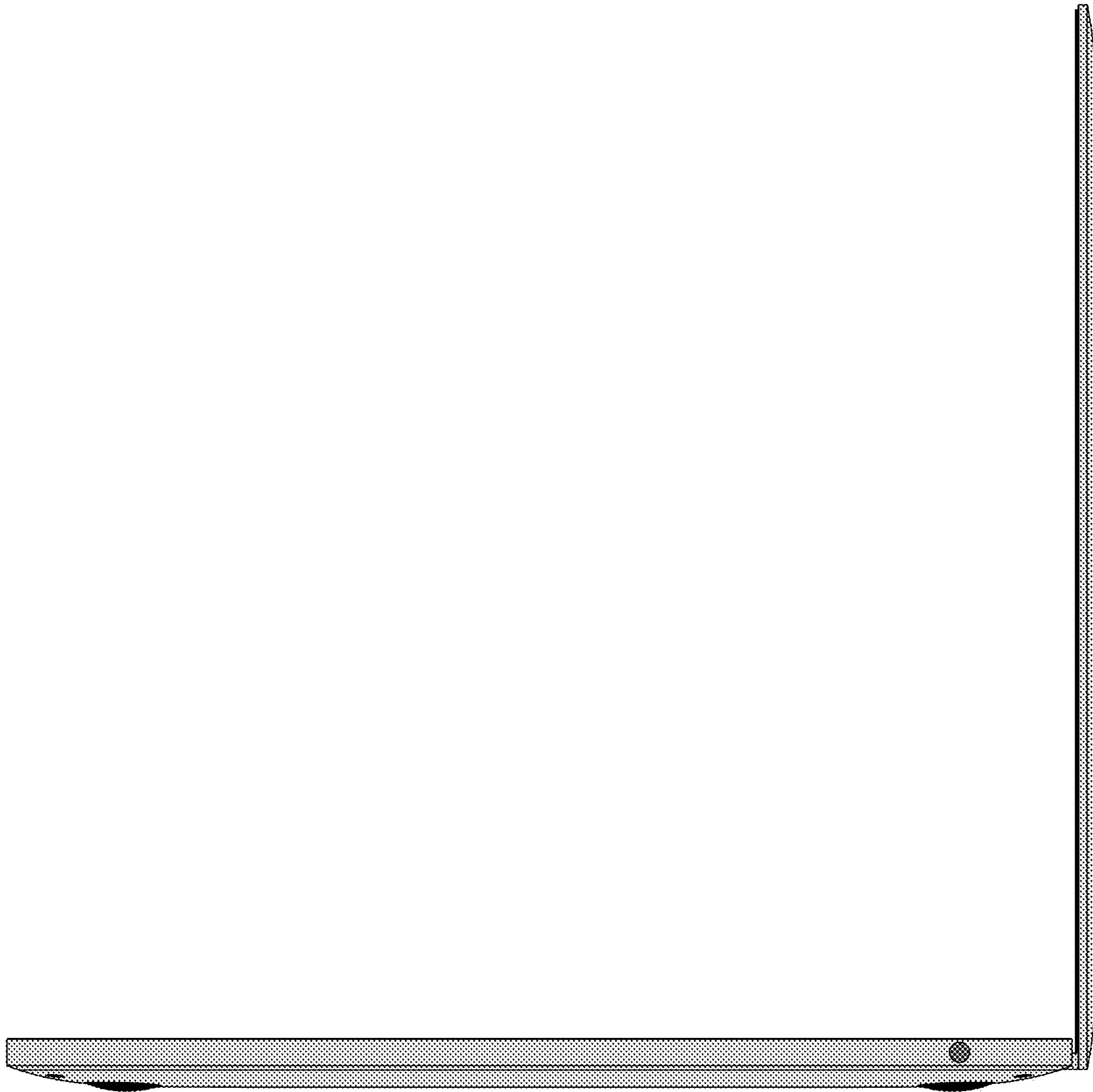

FIG. 14

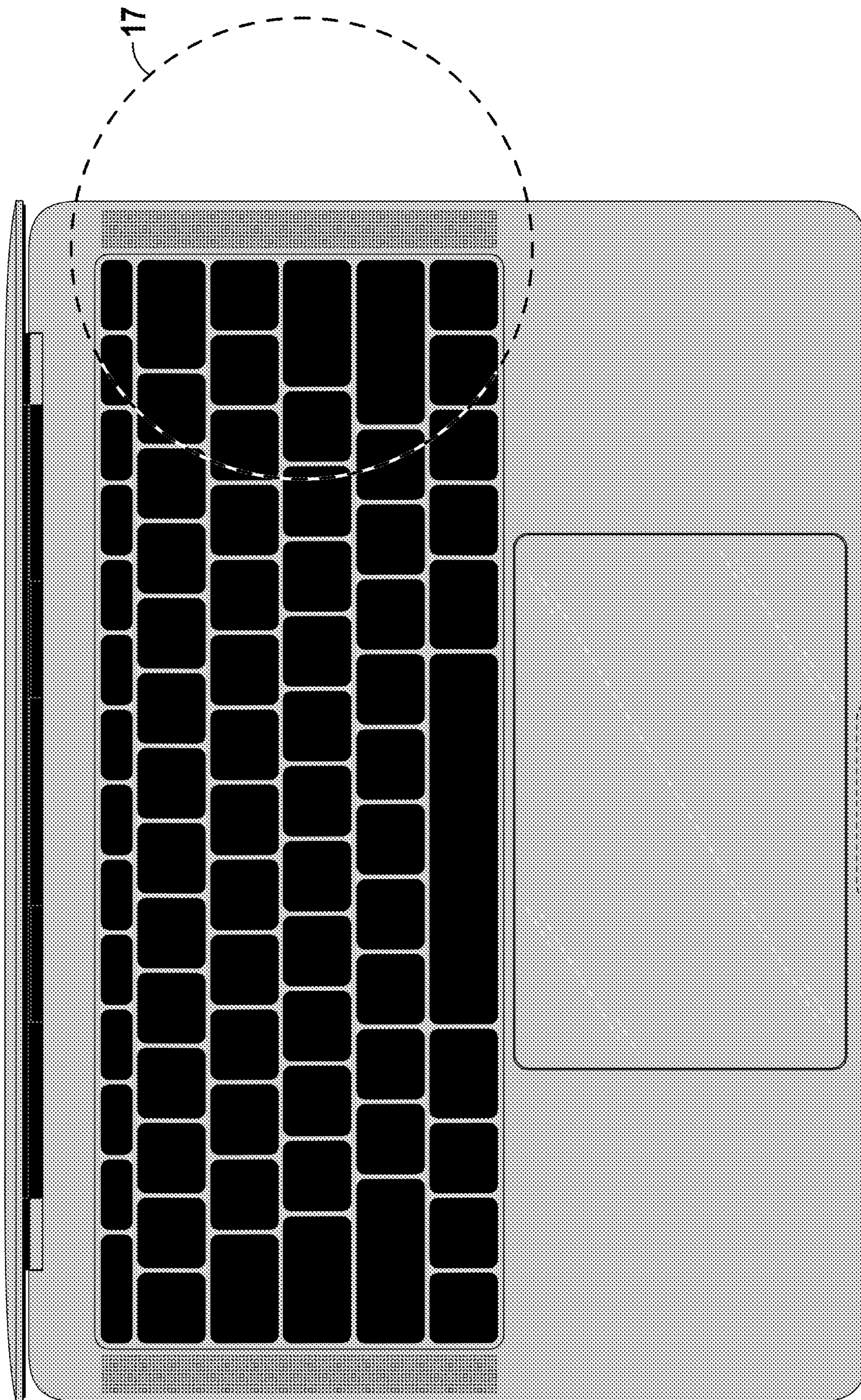

FIG. 15

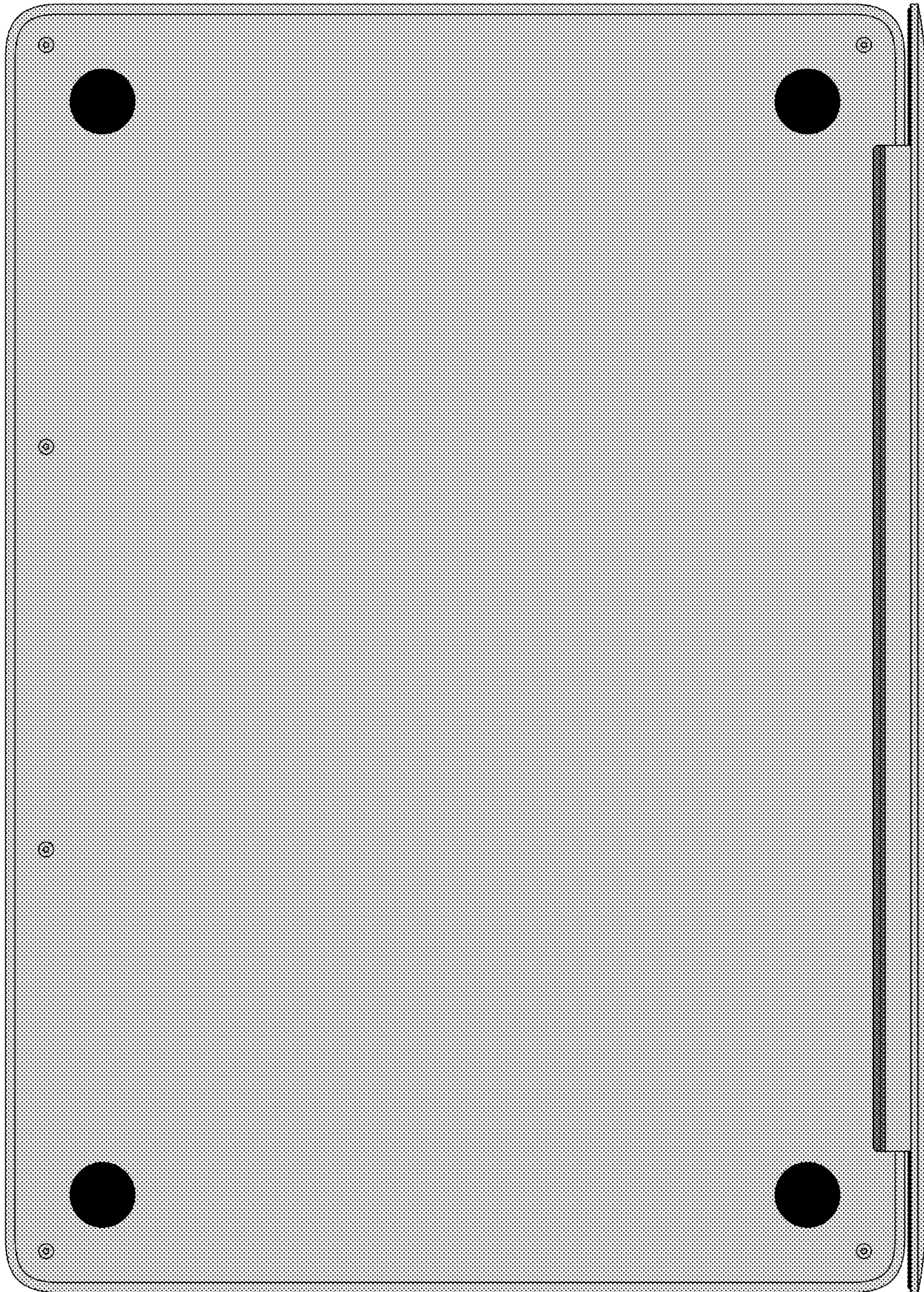

FIG. 16

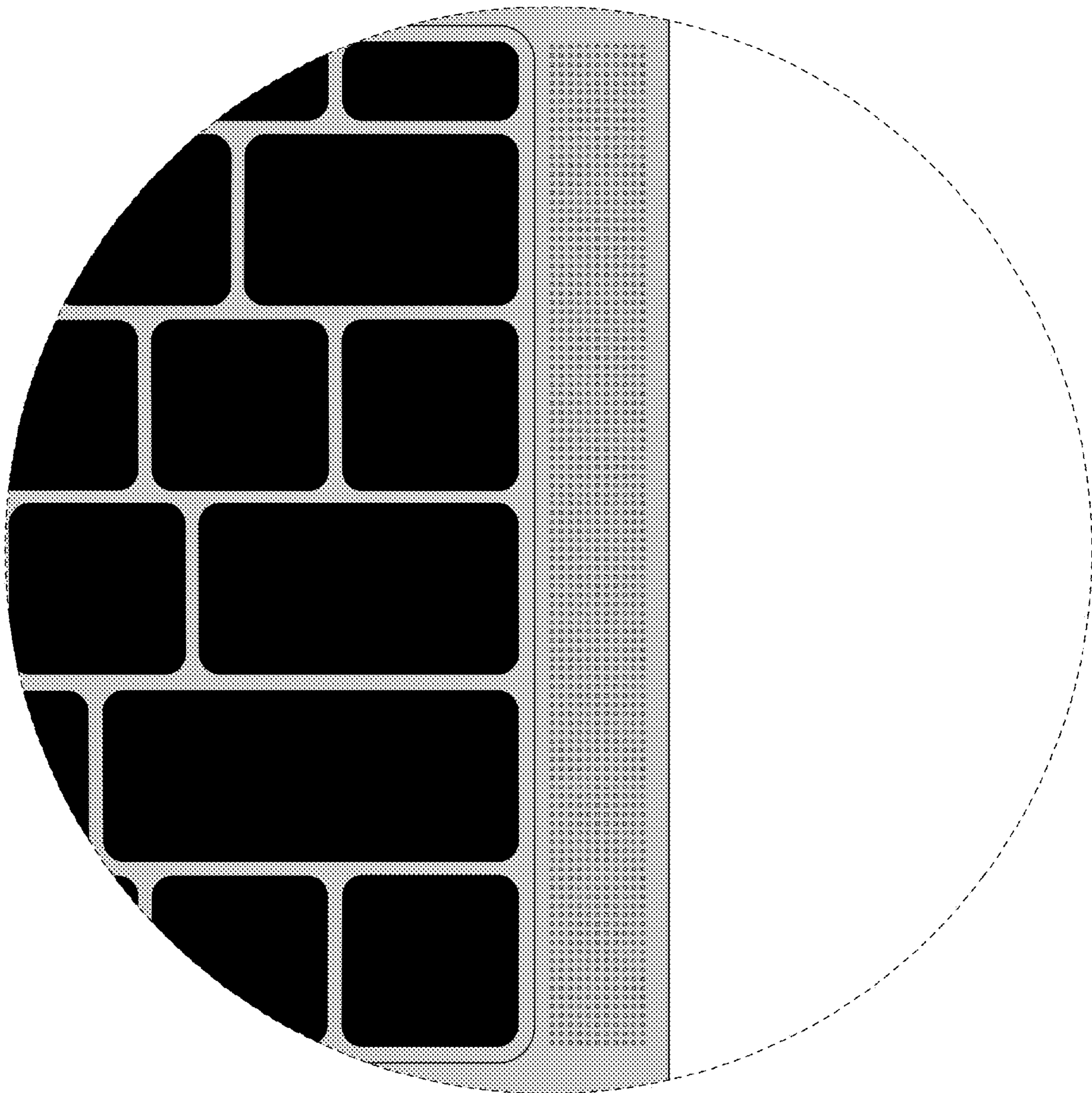

FIG. 17