



US00D890111S

(12) **United States Design Patent** (10) **Patent No.:** **US D890,111 S**
Park et al. (45) **Date of Patent:** **** Jul. 14, 2020**

(54) **ELECTRONIC DEVICE**

(71) Applicant: **Samsung Electronics Co., Ltd.**,
Suwon-si (KR)

(72) Inventors: **Hyoung Shin Park**, Suwon-si (KR);
Seung Ho Jang, Suwon-si (KR); **Dong
Kyun Kim**, Suwon-si (KR); **Seon
Keun Park**, Suwon-si (KR); **Chang
Sin Cho**, Suwon-si (KR)

(73) Assignee: **Samsung Electronics Co., Ltd.**,
Suwon-si (KR)

(**) Term: **15 Years**

(21) Appl. No.: **29/676,966**

(22) Filed: **Jan. 16, 2019**

(30) **Foreign Application Priority Data**

Jul. 23, 2018 (KR) 30-2018-0033899

Jul. 23, 2018 (KR) 30-2018-0033900

(51) **LOC (12) Cl.** **14-03**

(52) **U.S. Cl.**
USPC **D14/138 G**

(58) **Field of Classification Search**
USPC D14/138 G, 248, 341, 371, 374, 138 R,
D14/138 AA, 138 AB, 138 AC, 138 AD,
D14/138 C, 247

(Continued)

(56) **References Cited**

U.S. PATENT DOCUMENTS

D548,218 S * 8/2007 Hong D14/138 AA

D555,616 S * 11/2007 Lin D14/138 AD

(Continued)

OTHER PUBLICATIONS

Samsung Galaxy S10 5G, announced Feb. 2019, [online], [retrieved
on May 22, 2019]. Retrieved from Internet ,<URL: <http://www.gsmarena.com>>.*

(Continued)

Primary Examiner — Bridget L Eland

(74) *Attorney, Agent, or Firm* — NSIP Law

(57) **CLAIM**

We claim the ornamental design for an electronic device, as
shown and described.

DESCRIPTION

FIG. 1 is a front perspective view of an electronic device
showing our new design according to a first embodiment;
FIG. 2 is a front view thereof;
FIG. 3 is a rear view thereof;
FIG. 4 is a left-side view thereof;
FIG. 5 is a right-side view thereof;
FIG. 6 is a top view thereof;
FIG. 7 is a bottom view thereof;
FIG. 8 is a rear perspective view thereof;
FIG. 9 is a front perspective view of an electronic device
showing our new design according to a second embodiment;
FIG. 10 is a front view thereof;
FIG. 11 is a rear view thereof;
FIG. 12 is a left-side view thereof;
FIG. 13 is a right-side view thereof;
FIG. 14 is a top plan view thereof;
FIG. 15 is a bottom plan view thereof;
FIG. 16 is a rear perspective view thereof;
FIG. 17 is a front perspective view of an electronic device
showing our new design according to a third embodiment;
FIG. 18 is a front view thereof;
FIG. 19 is a rear view thereof;
FIG. 20 is a left-side view thereof;
FIG. 21 is a right-side view thereof;
FIG. 22 is a top plan view thereof;
FIG. 23 is a bottom plan view thereof;
FIG. 24 is a rear perspective view thereof;
FIG. 25 is a front perspective view of an electronic device
showing our new design according to a fourth embodiment;
FIG. 26 is a front view thereof;
FIG. 27 is a rear view thereof;
FIG. 28 is a left-side view thereof;
FIG. 29 is a right-side view thereof;
FIG. 30 is a top plan view thereof;

(Continued)

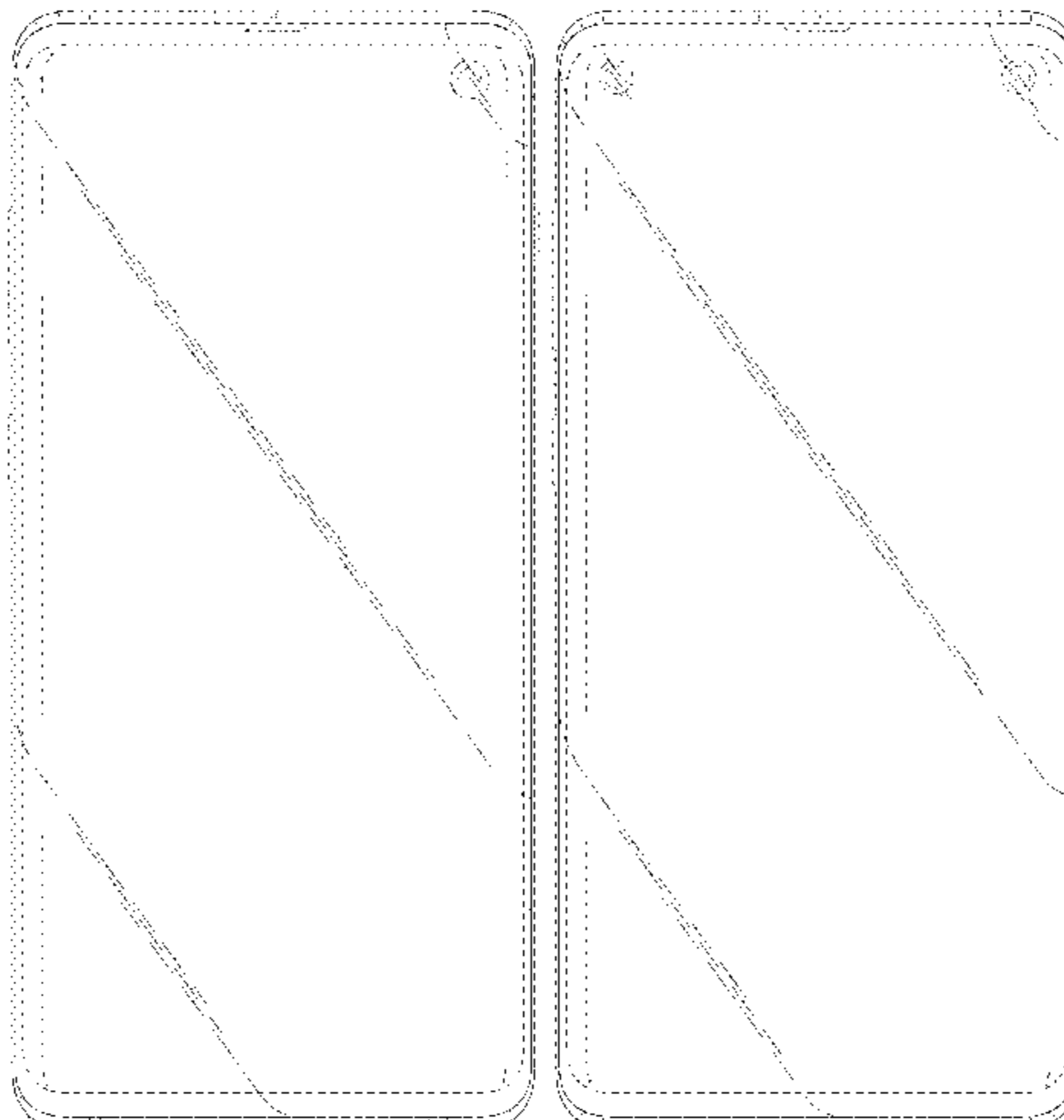

FIG. 31 is a bottom plan view thereof;
 FIG. 32 is a rear perspective view thereof;
 FIG. 33 is a front view of an electronic device showing our new design according to a fifth embodiment;
 FIG. 34 is a front view of an electronic device showing our new design according to a sixth embodiment;
 FIG. 35 is a front view of an electronic device showing our new design according to a seventh embodiment;
 FIG. 36 is a front view of an electronic device showing our new design according to an eighth embodiment;
 FIG. 37 is a front view of an electronic device showing our new design according to a ninth embodiment;
 FIG. 38 is a front view of an electronic device showing our new design according to a tenth embodiment;
 FIG. 39 is a front view of an electronic device showing our new design according to an eleventh embodiment;
 FIG. 40 is a front view of an electronic device showing our new design according to a twelfth embodiment;
 FIG. 41 is a front perspective view of an electronic device showing our new design according to a thirteenth embodiment;
 FIG. 42 is a front view thereof;
 FIG. 43 is a rear view thereof;
 FIG. 44 is a left-side view thereof;
 FIG. 45 is a right-side view thereof;
 FIG. 46 is a top plan view thereof;
 FIG. 47 is a bottom plan view thereof;
 FIG. 48 is a rear perspective view thereof;
 FIG. 49 is a front perspective view of an electronic device showing our new design according to a fourteenth embodiment;
 FIG. 50 is a front view thereof;
 FIG. 51 is a rear view thereof;
 FIG. 52 is a left-side view thereof;
 FIG. 53 is a right-side view thereof;
 FIG. 54 is a top plan view thereof;
 FIG. 55 is a bottom plan view thereof; and,
 FIG. 56 is a rear perspective view thereof.

The evenly-dashed broken lines in the figures depict portions of the electronic device which form no part of the claimed design.

The dot-dash broken lines in the figures represent boundaries of the claimed design and form no part thereof. The appearance of any portion of the article between the evenly-spaced pairs of dot-dash broken lines forms no part of the claimed design.

The rear, left-side, right-side, top, bottom and rear perspective views of the fifth through twelfth embodiments of the electronic device depicted in FIGS. 33 through 40 have been omitted because they are exact duplicates of the same views of the electronic device design that are depicted in FIGS. 11 through 16.

1 Claim, 56 Drawing Sheets

(58) **Field of Classification Search**

CPC H04M 1/0202; H04M 1/0235; H04M 1/0237; H04M 1/0239; H04M 1/0266; H04M 1/0268; H04M 1/027; H04M 1/0295

See application file for complete search history.

(56)

References Cited

U.S. PATENT DOCUMENTS

D558,726	S	*	1/2008	Wang	D14/138	AD
D577,704	S	*	9/2008	Park	D14/138	AD
D584,708	S	*	1/2009	Wu	D14/138	AD
D585,416	S	*	1/2009	Kim	D14/138	AD
D589,487	S	*	3/2009	Park	D14/138	AD
D607,429	S	*	1/2010	Lim	D14/138	AD
D616,852	S	*	6/2010	Kim	D14/138	AD
D620,469	S	*	7/2010	Chang	D14/138	AD
D656,477	S	*	3/2012	Yi	D14/138	G
D686,586	S	*	7/2013	Cho	D14/138	G
D694,730	S	*	12/2013	Lee	D14/138	G
D695,255	S	*	12/2013	Kim	D14/138	G
D700,164	S	*	2/2014	Park	D14/138	G
D783,565	S	*	4/2017	Kim	D14/138	G
D783,566	S	*	4/2017	Kim	D14/138	G
D803,176	S	*	11/2017	Cho	D14/138	G
D807,851	S	*	1/2018	Cho	D14/138	G
D807,853	S	*	1/2018	Oh	D14/138	G
D813,186	S	*	3/2018	Lee	D14/138	G
D815,080	S	*	4/2018	Cho	D14/248	
D831,605	S	*	10/2018	Baik	D14/138	G
D839,848	S	*	2/2019	Baik	D14/138	G
D847,776	S	*	5/2019	Ryu	D14/138	G
D849,706	S	*	5/2019	Park	D14/138	G
D854,508	S	*	7/2019	Park	D14/138	C
D856,958	S	*	8/2019	Seo	D14/138	G
D857,643	S	*	8/2019	Choi	D14/138	G
D860,152	S	*	9/2019	Cho	D14/138	G
D861,630	S	*	10/2019	Chiang	D14/138	G
D865,732	S	*	11/2019	Park	D14/248	
D865,733	S	*	11/2019	Park	D14/248	
D865,734	S	*	11/2019	Park	D14/248	
D865,735	S	*	11/2019	Park	D14/248	
D865,737	S	*	11/2019	Park	D14/248	
D865,738	S	*	11/2019	Park	D14/248	
D866,496	S	*	11/2019	Kim	D14/138	G
D866,540	S	*	11/2019	Park	D14/248	
D866,541	S	*	11/2019	Park	D14/248	
D866,542	S	*	11/2019	Park	D14/248	
D867,317	S	*	11/2019	Ha	D14/138	G
D867,351	S	*	11/2019	Park	D14/248	
D871,360	S	*	12/2019	Seo	D14/138	G
D872,703	S	*	1/2020	Seo	D14/138	G
10,530,911	B2	*	1/2020	Bao	H04N 7/0127	
D875,701	S	*	2/2020	Park	D14/138	G
D876,383	S	*	2/2020	Park	D14/138	G
D876,384	S	*	2/2020	Park	D14/138	G
2018/0196475	A1	*	7/2018	Bao	G06F 1/1637	
2019/0305403	A1	*	10/2019	Wang	H01Q 1/10	
2019/0312964	A1	*	10/2019	Haiberger	H04M 1/22	

OTHER PUBLICATIONS

Samsung Galaxy S10+, announced Feb. 2019, [online], [retrieved on May 22, 2019]. Retrieved from Internet ,<URL: <http://www.gsmarena.com>>.*

Samsung Galaxy S10e, announced Feb. 2019, [online], [retrieved on May 22, 2019]. Retrieved from Internet ,<URL: <http://www.gsmarena.com>>.*

Nokia X71, announced Apr. 2019, [online], [retrieved on May 22, 2019]. Retrieved from Internet ,<URL: <http://www.gsmarena.com>>.*

Motorola One Vision, announced May 2019, [online], [retrieved on May 22, 2019]. Retrieved from Internet ,<URL: <http://www.gsmarena.com>>.*

Honor 20, announced May 2019, [online], [retrieved on May 22, 2019]. Retrieved from Internet ,<URL: <http://www.gsmarena.com>>.*

* cited by examiner

FIG. 1

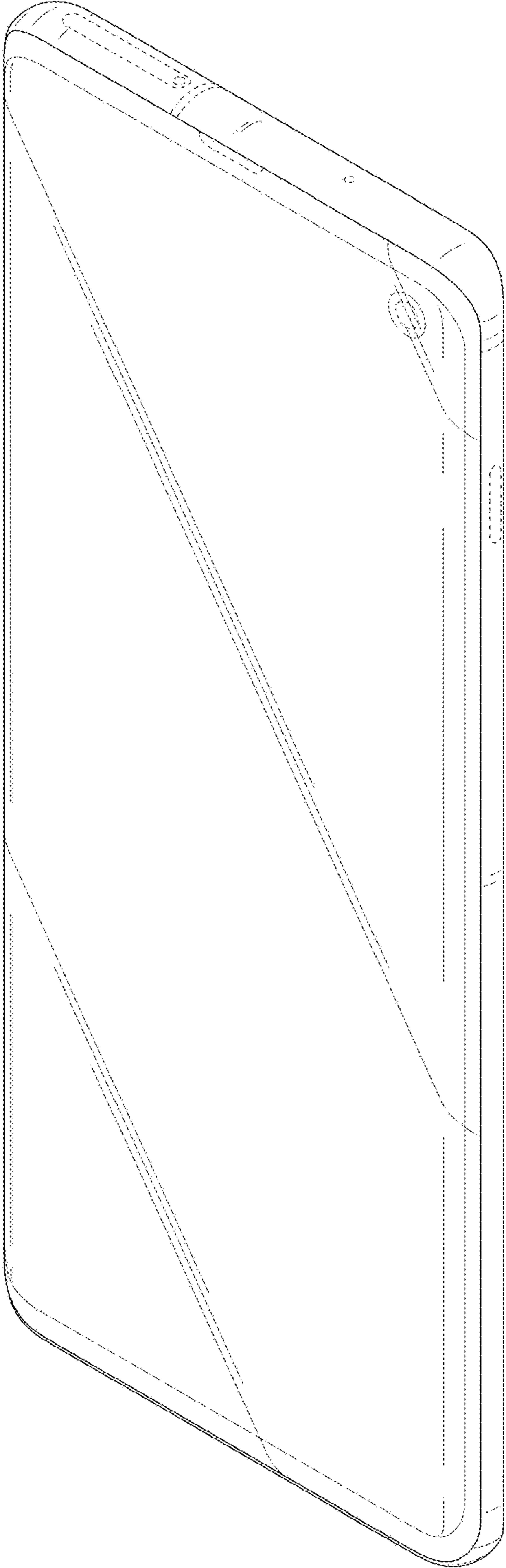

FIG. 2

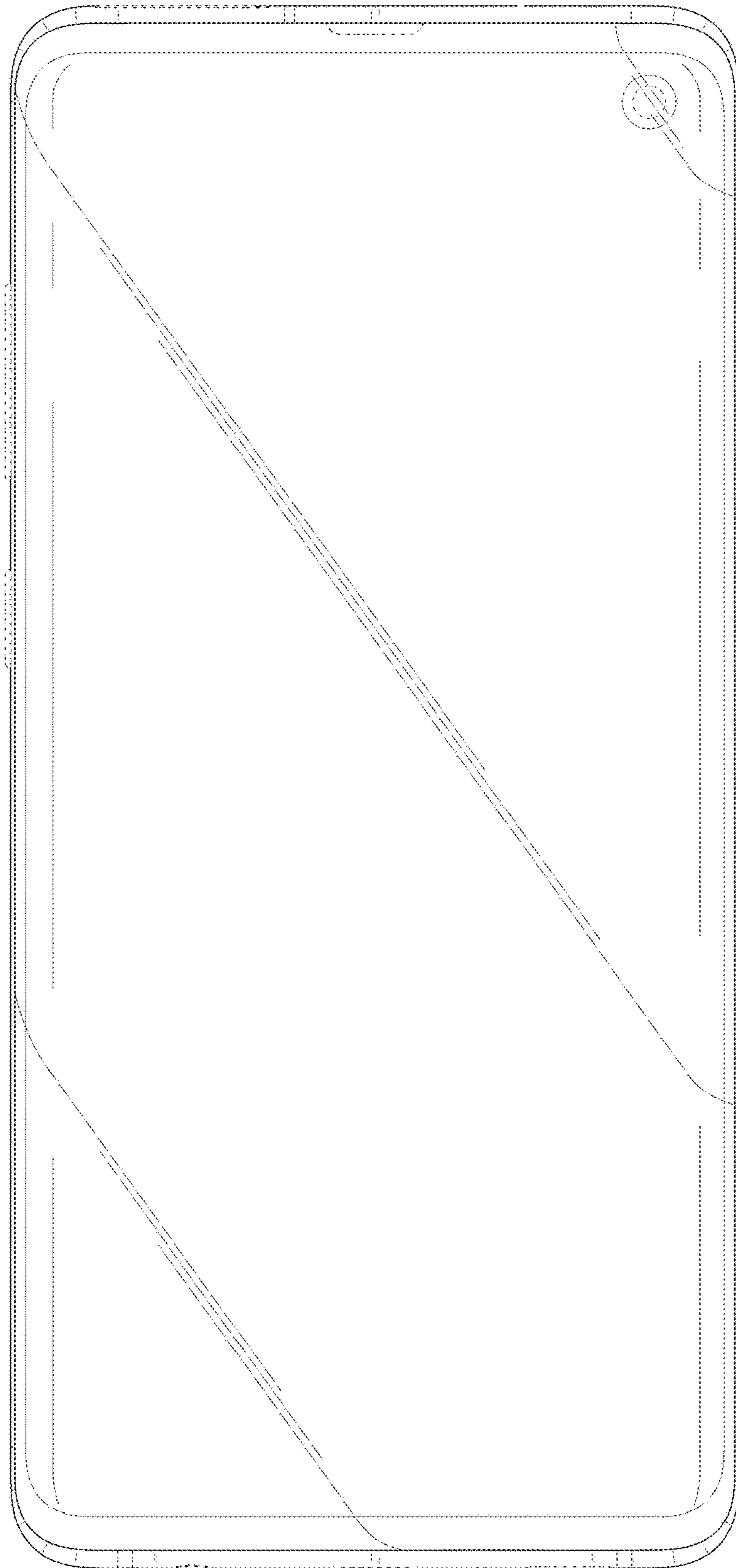

FIG. 3

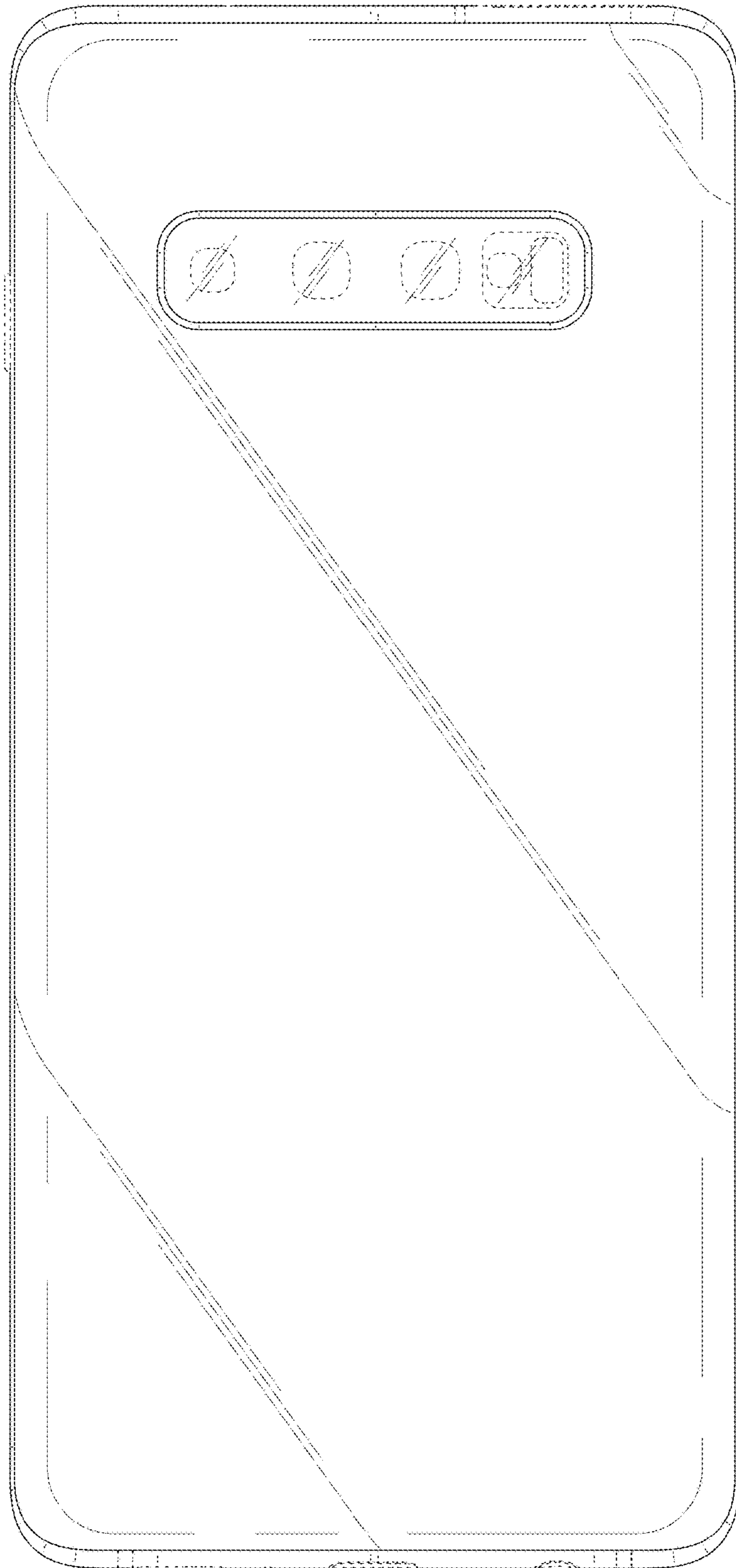

FIG. 4



FIG. 5

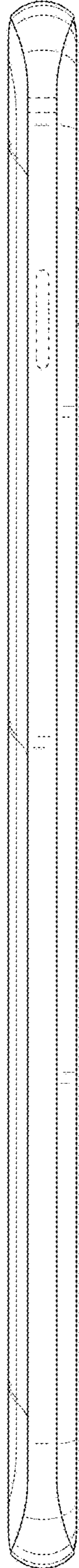

FIG. 6

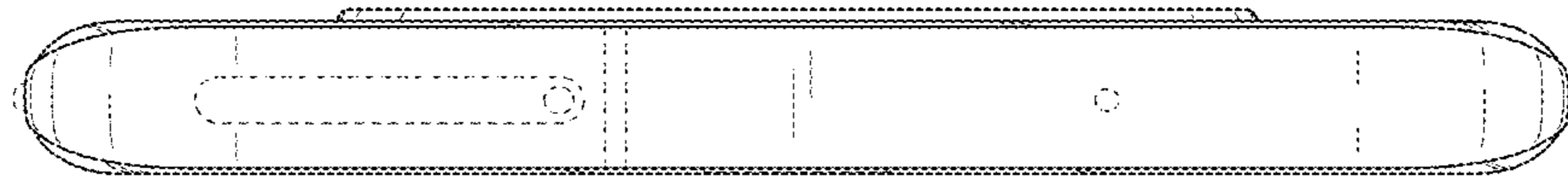

FIG. 7

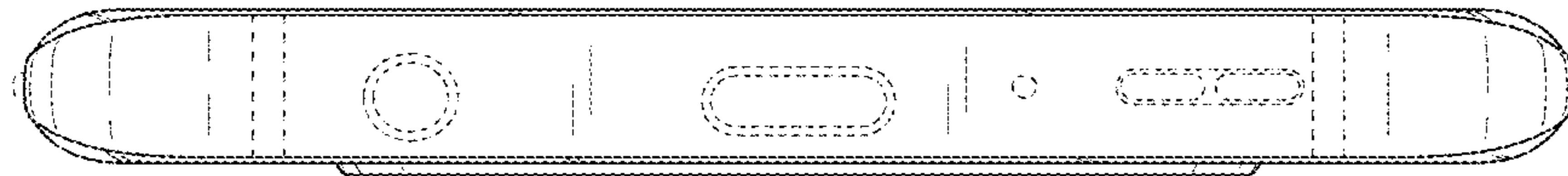

FIG. 8

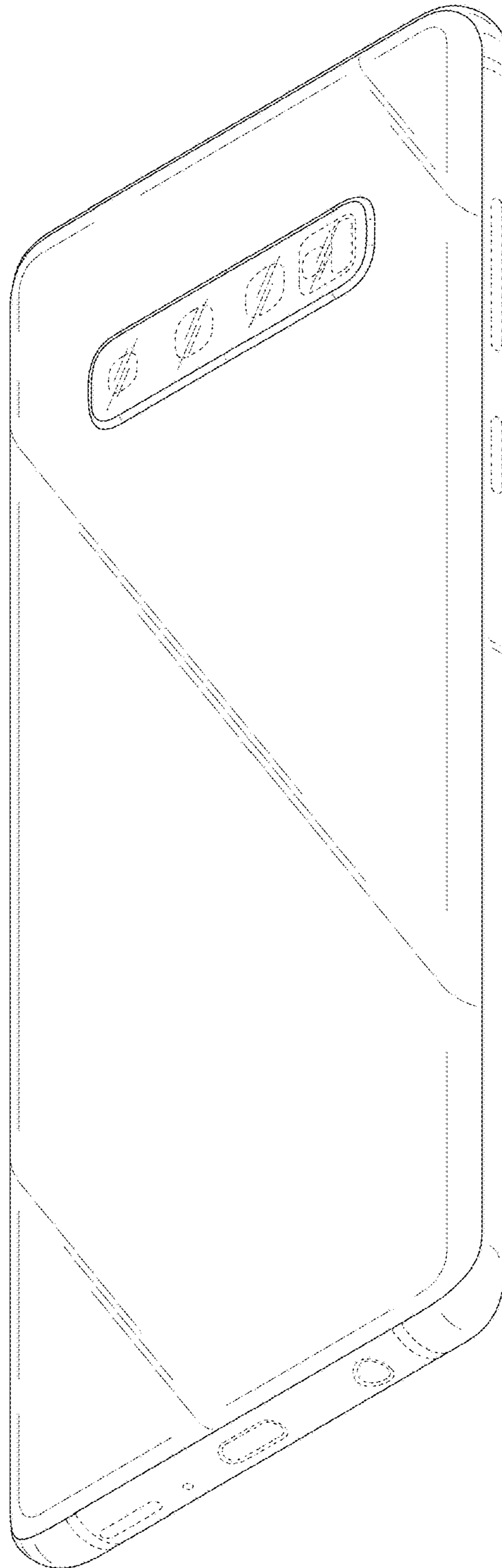

FIG. 9

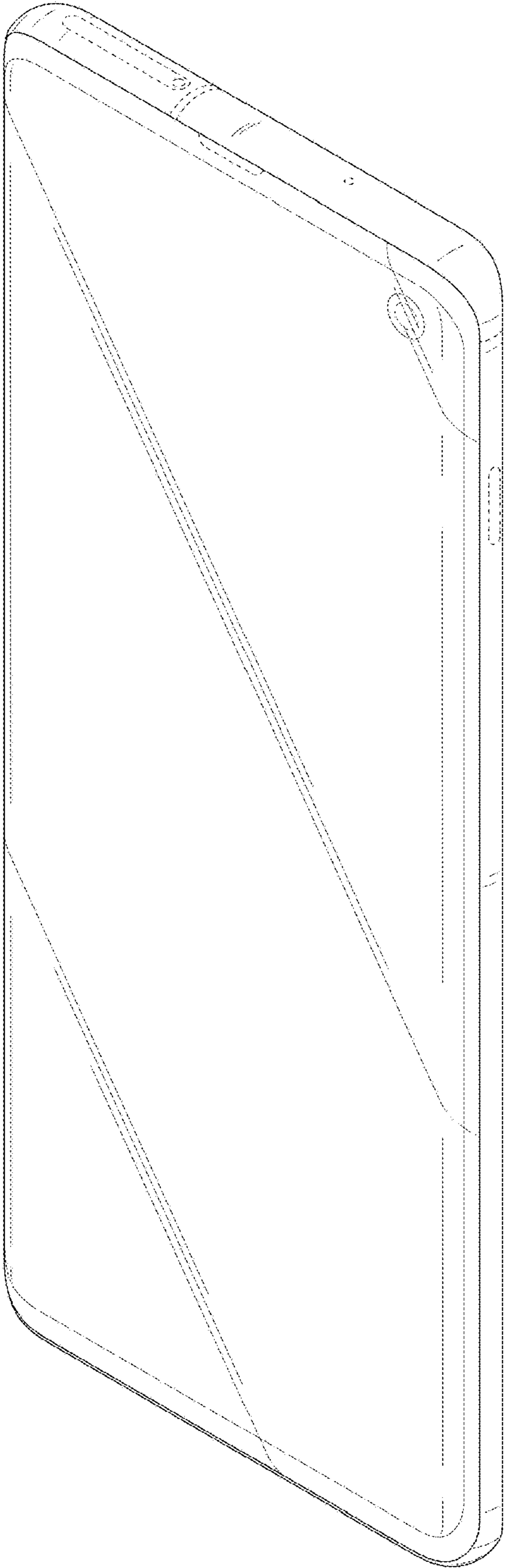

FIG. 10

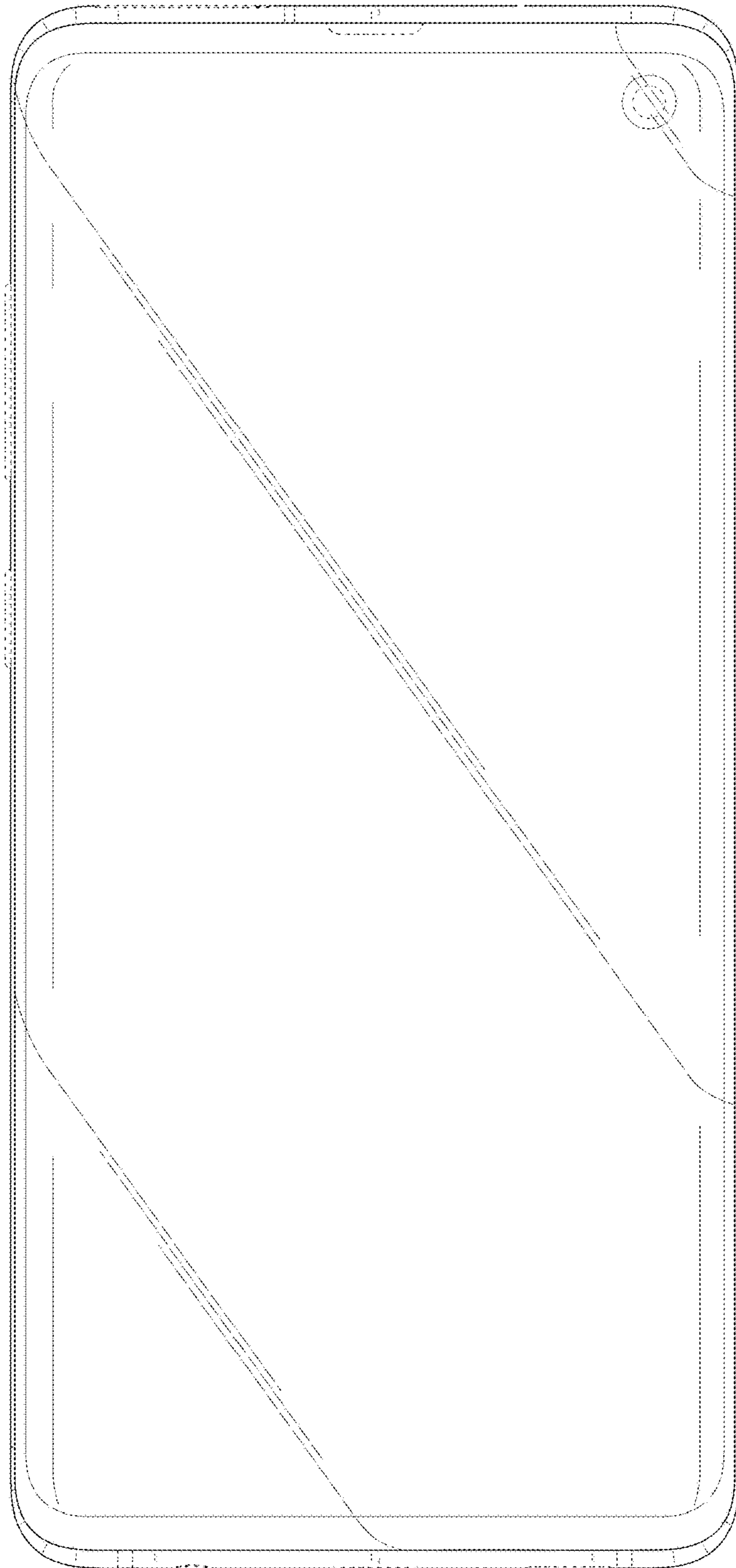

FIG. 11

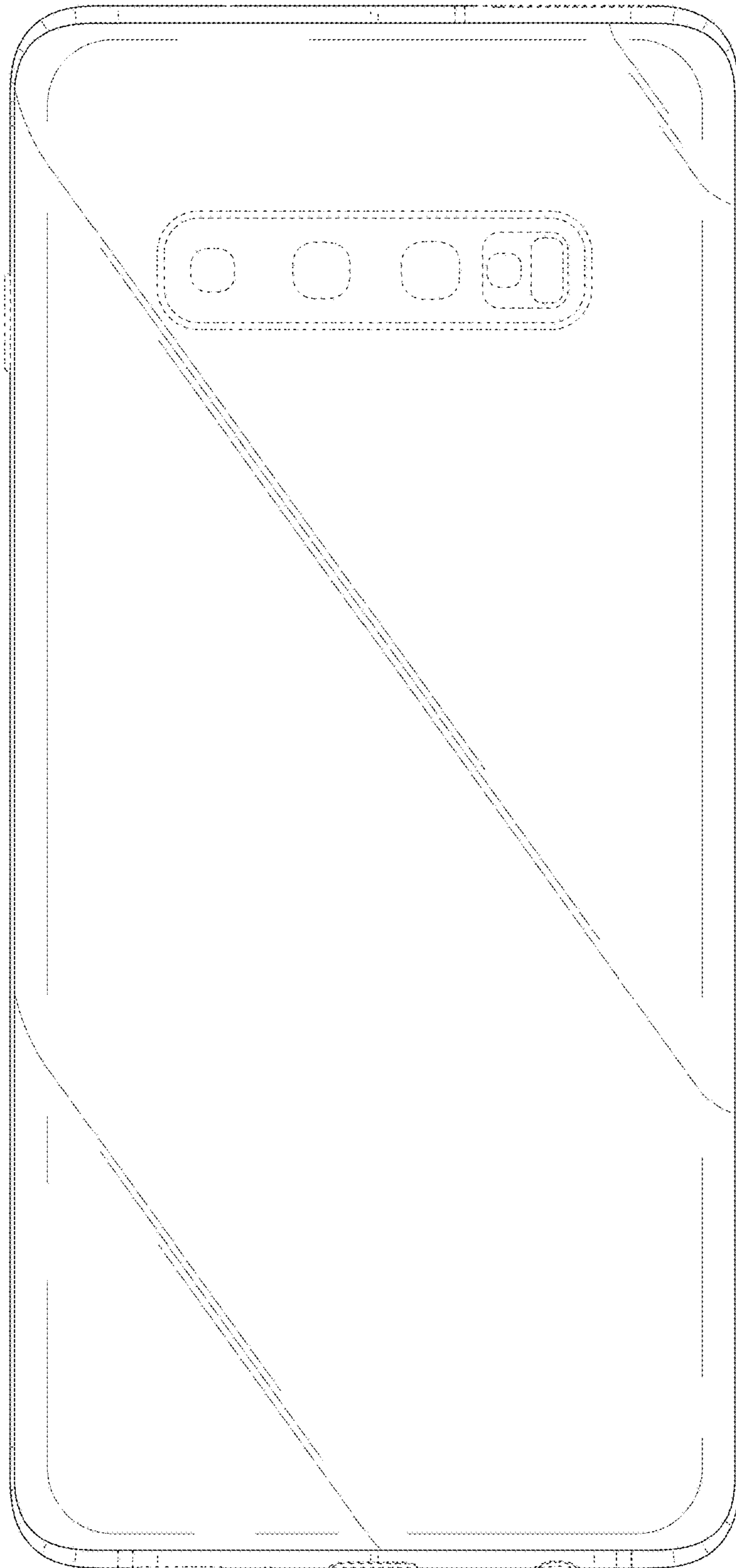

FIG. 12



FIG. 13

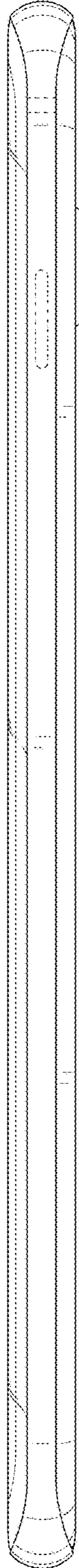

FIG. 14

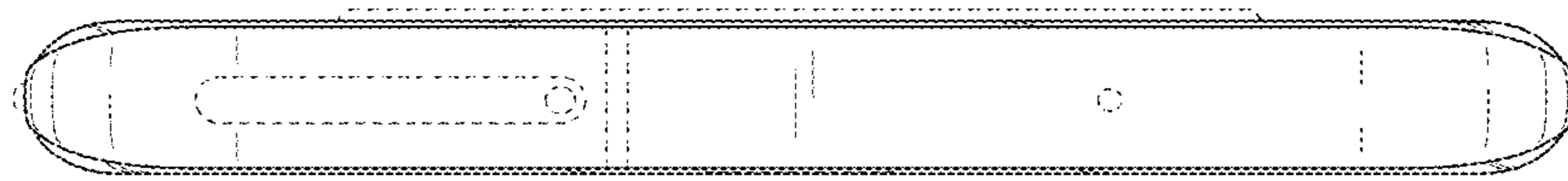

FIG. 15

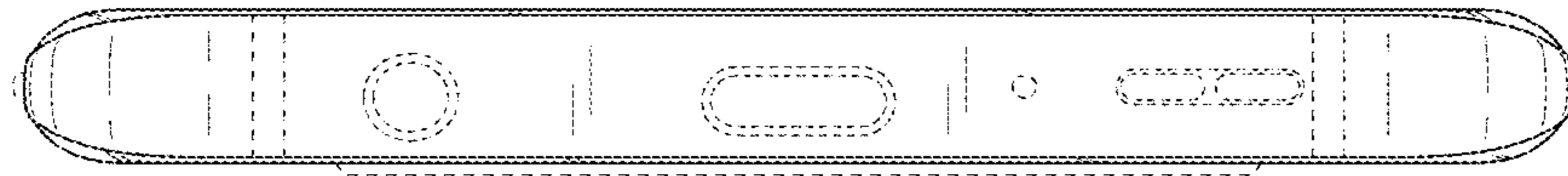

FIG. 16

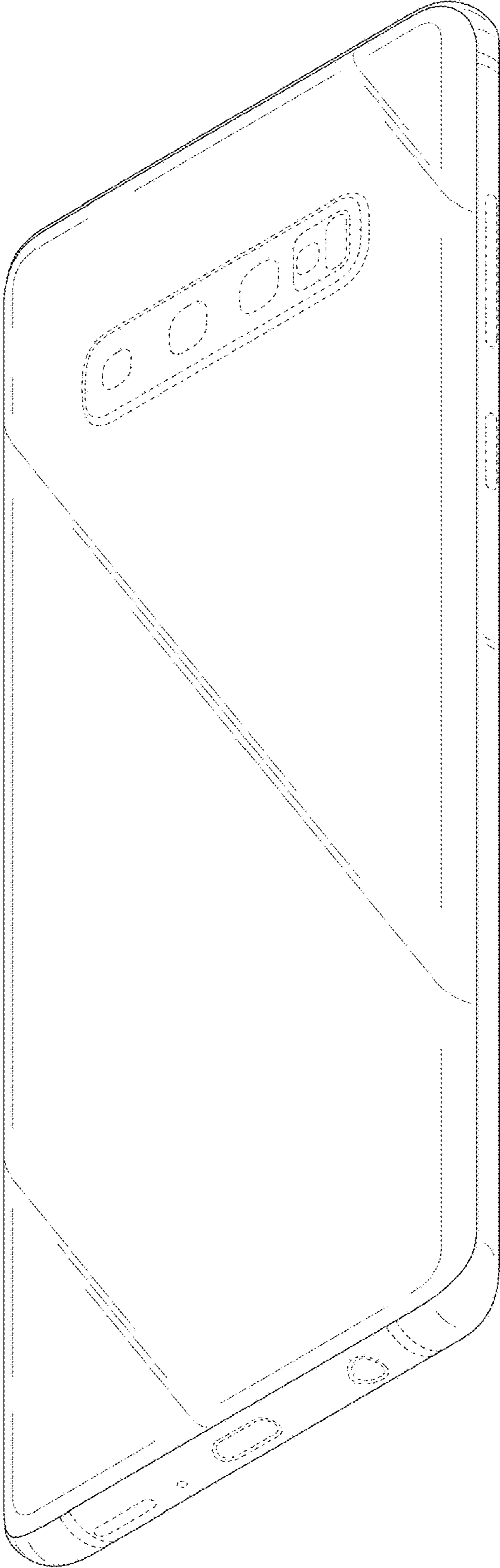

FIG. 17

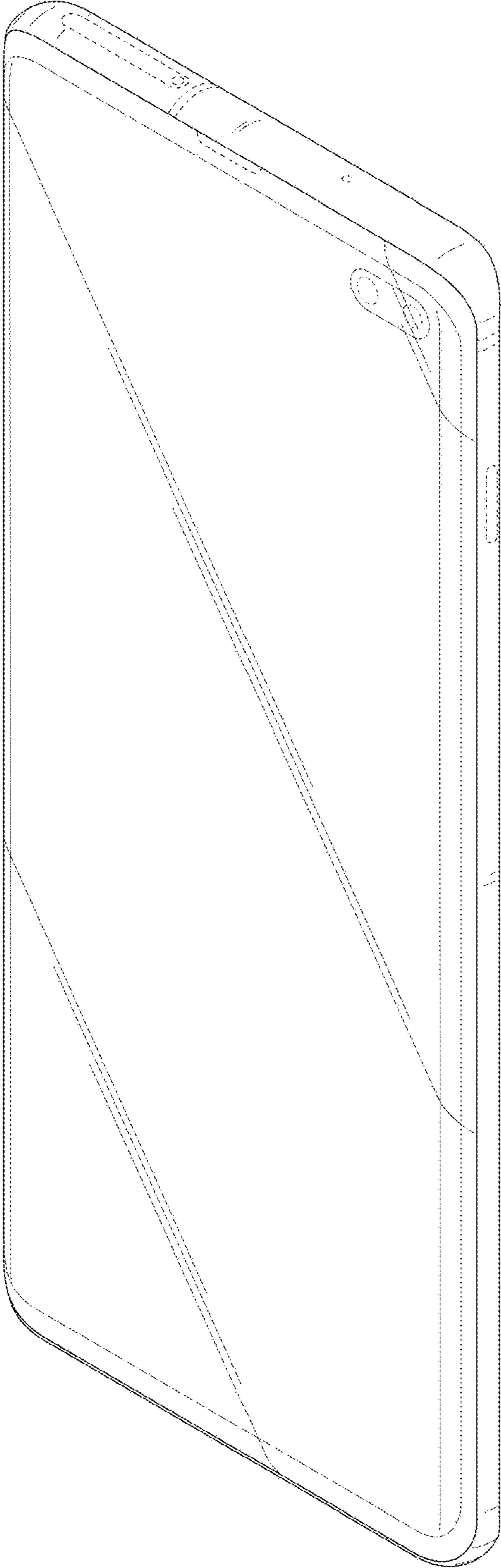

FIG. 18

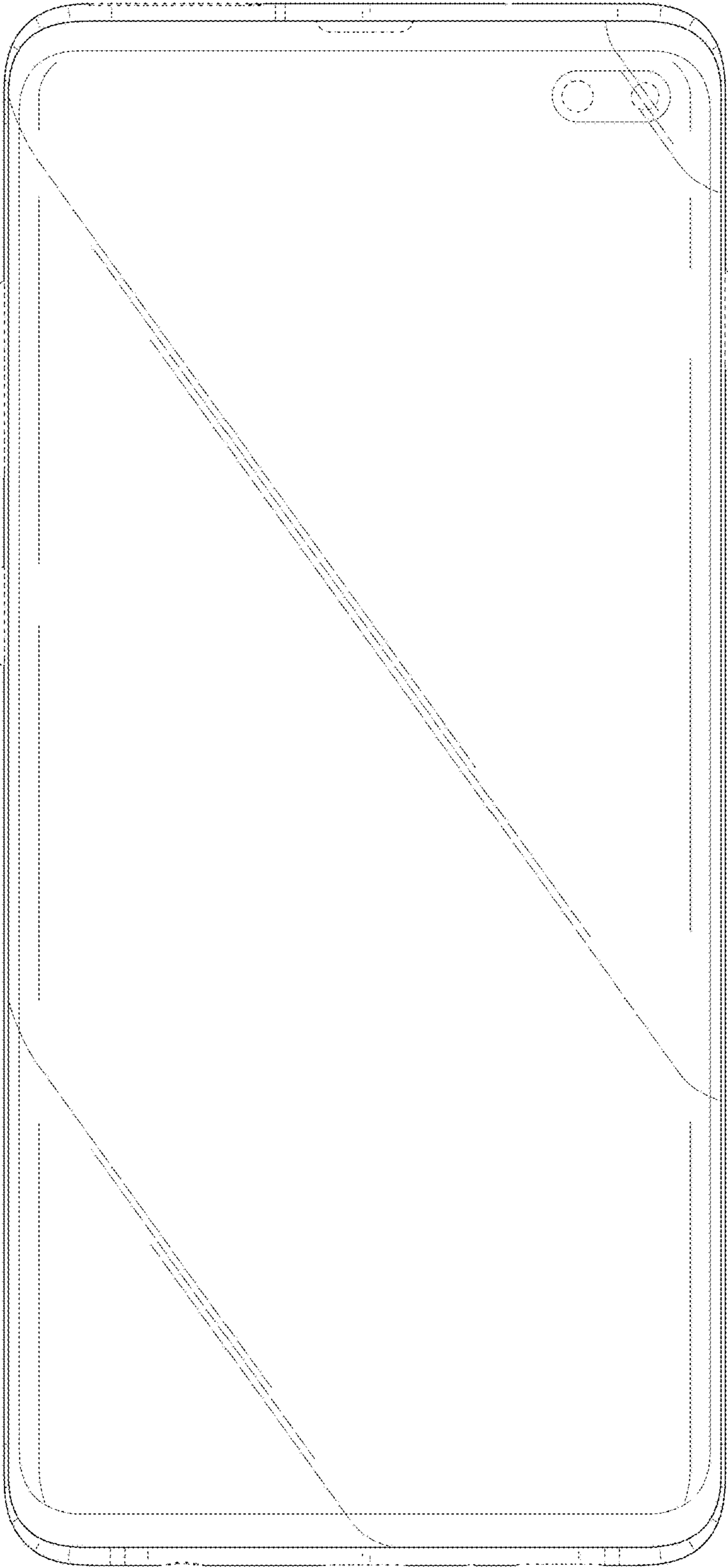

FIG. 19

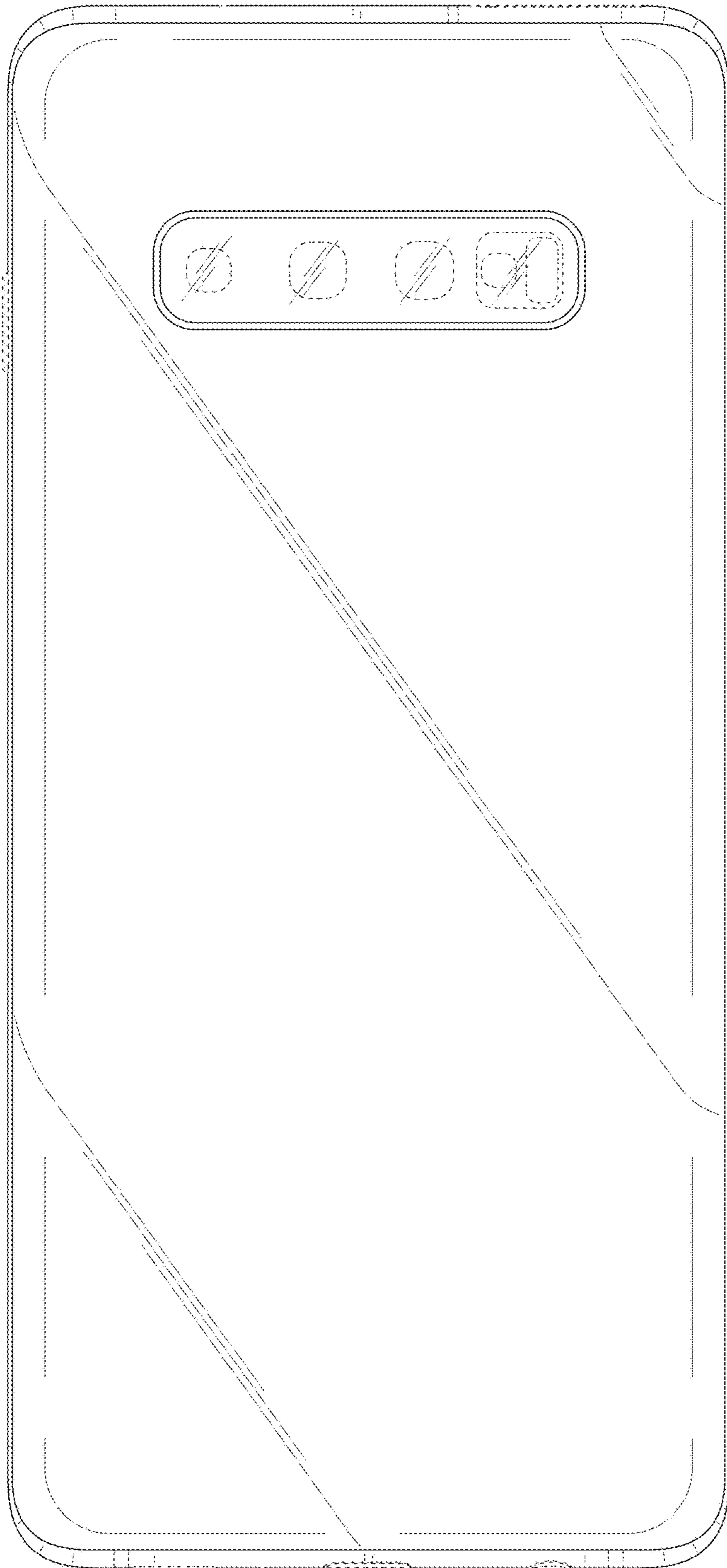

FIG. 20

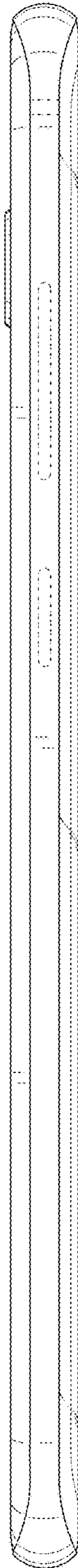

FIG. 21

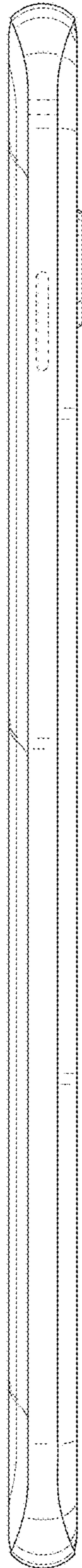

FIG. 22

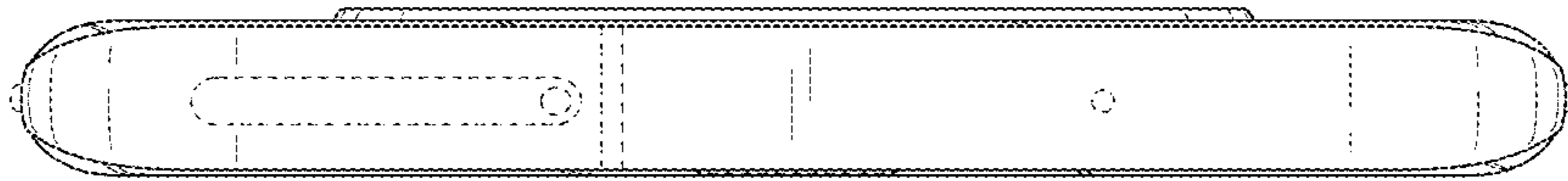

FIG. 23

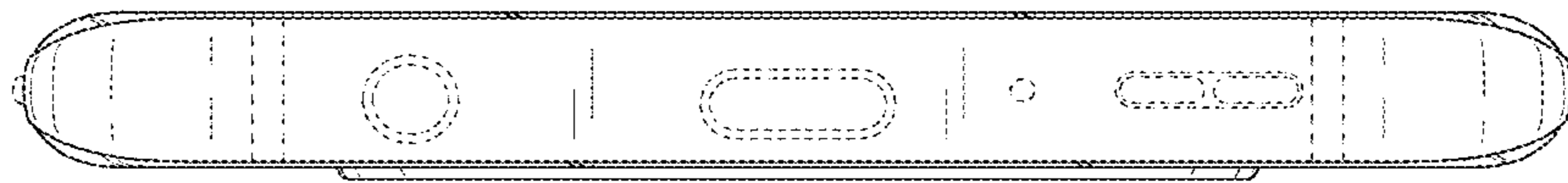

FIG. 24

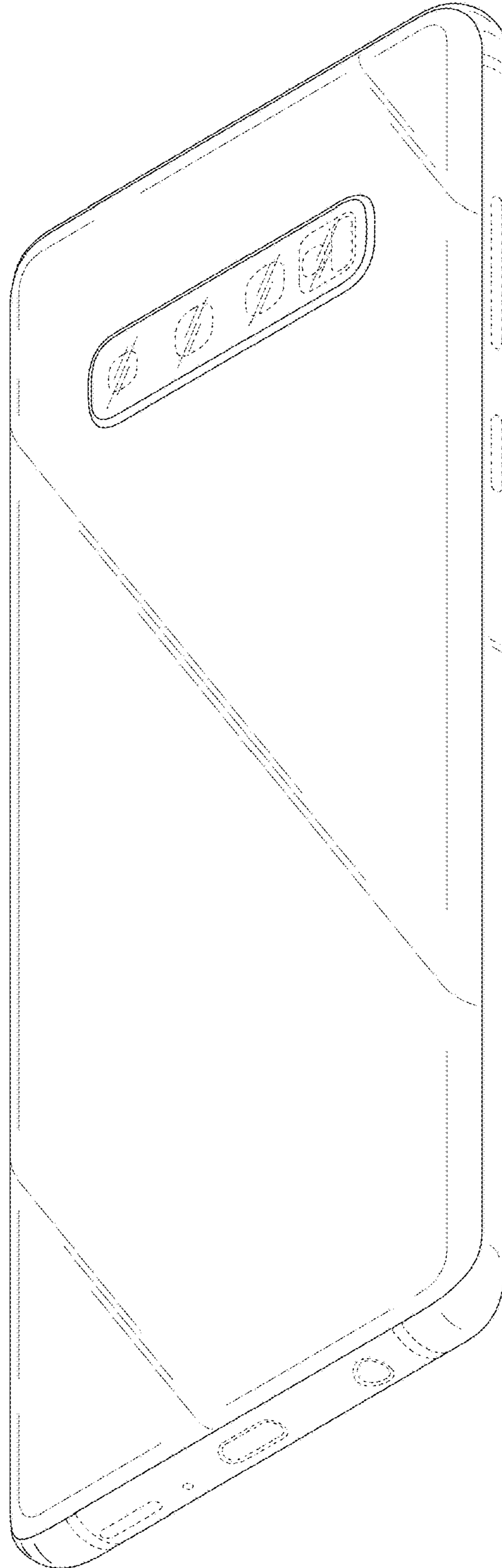

FIG. 25

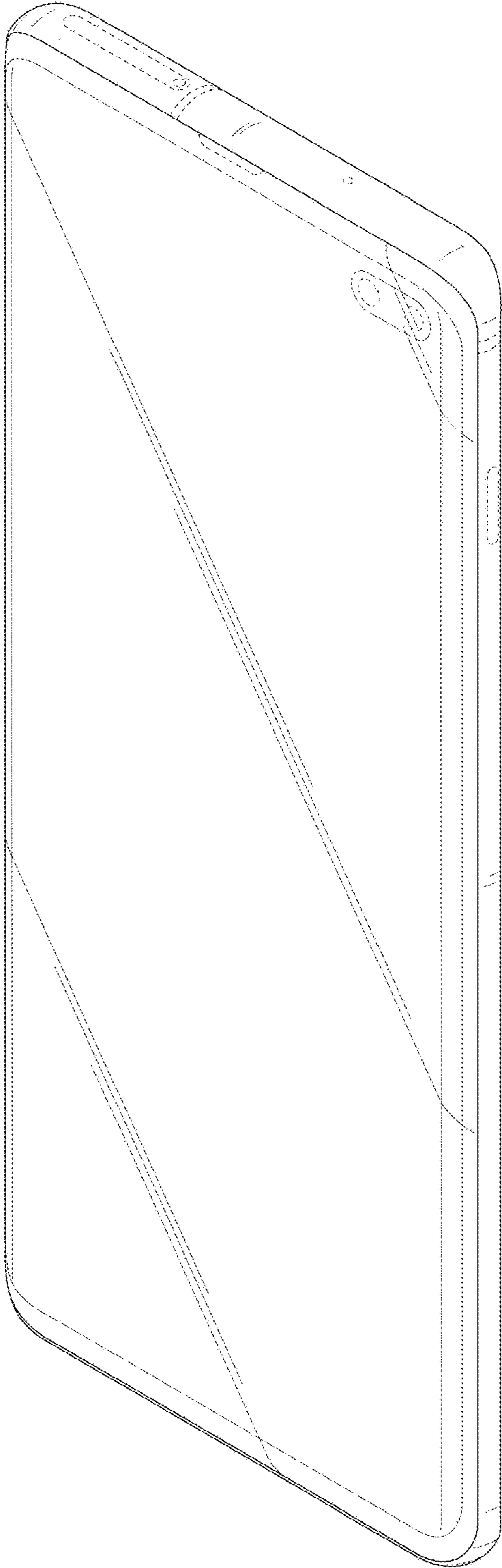

FIG. 26

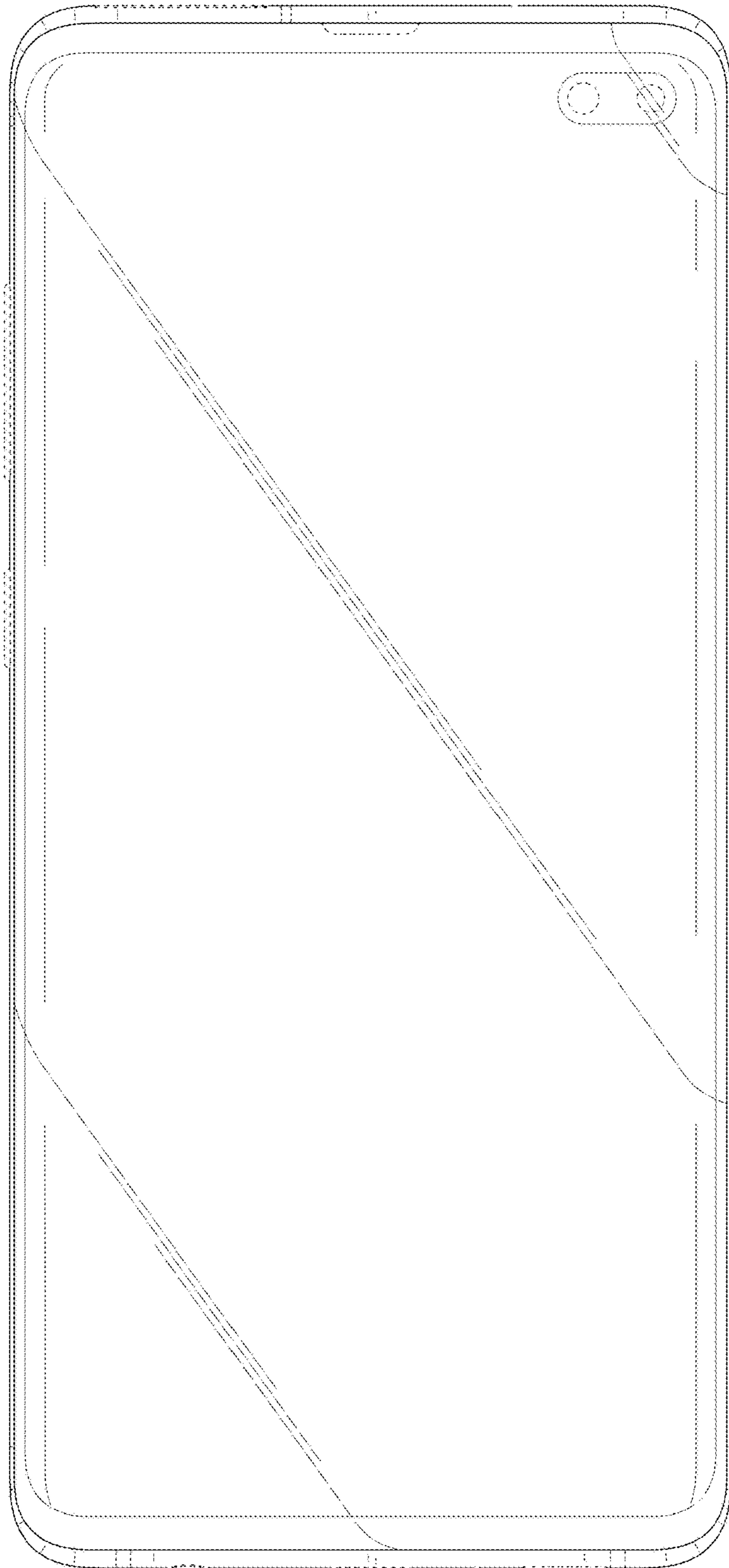

FIG. 27

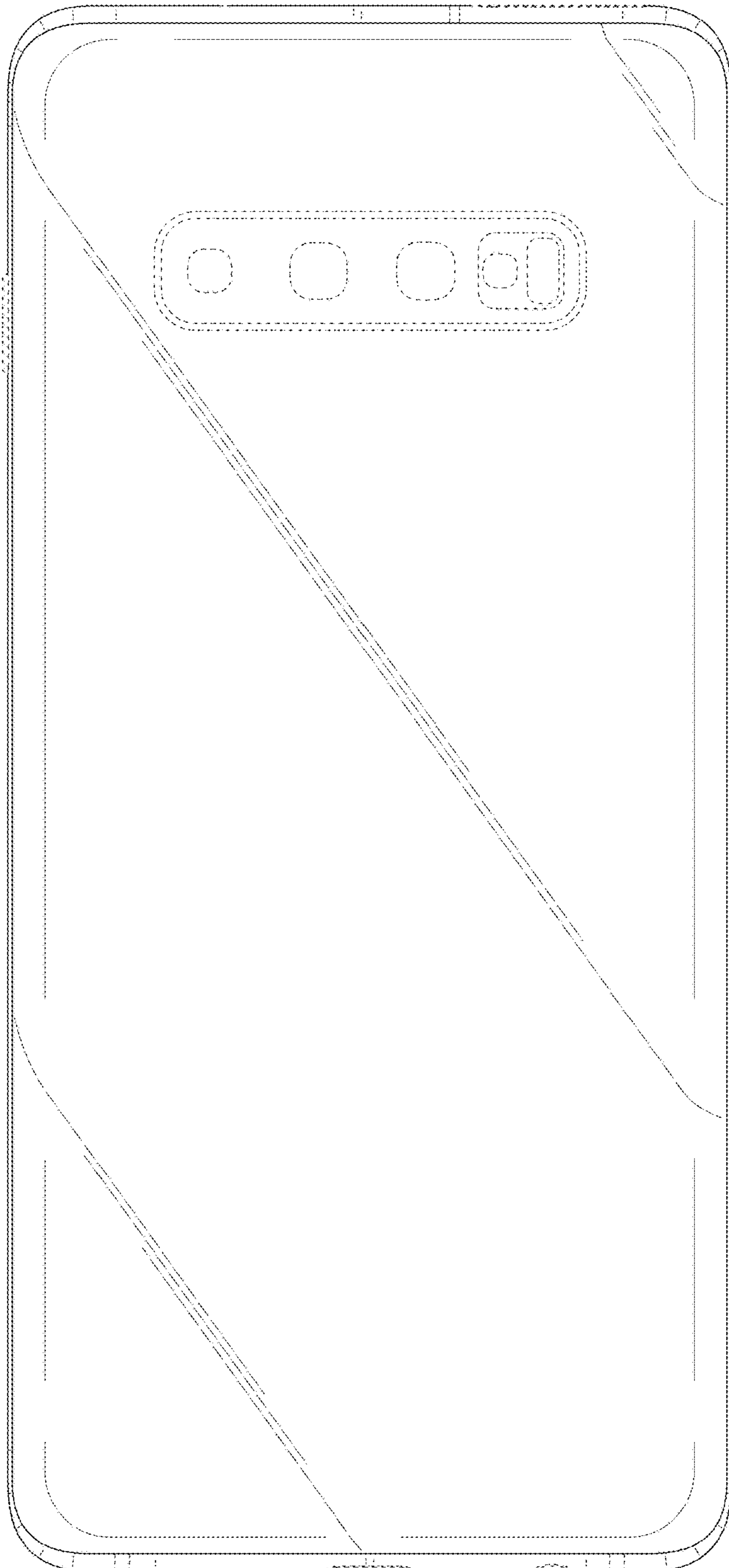

FIG. 28

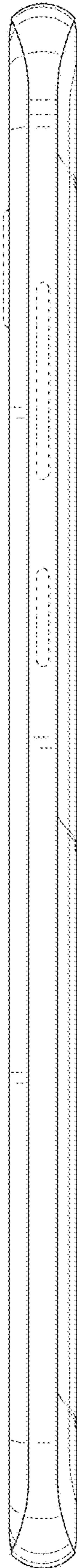

FIG. 29

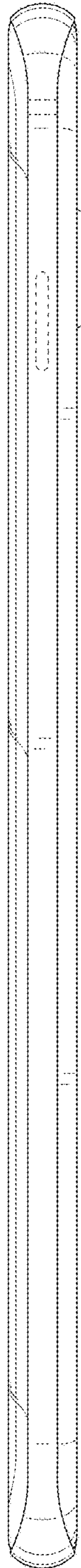

FIG. 30



FIG. 31

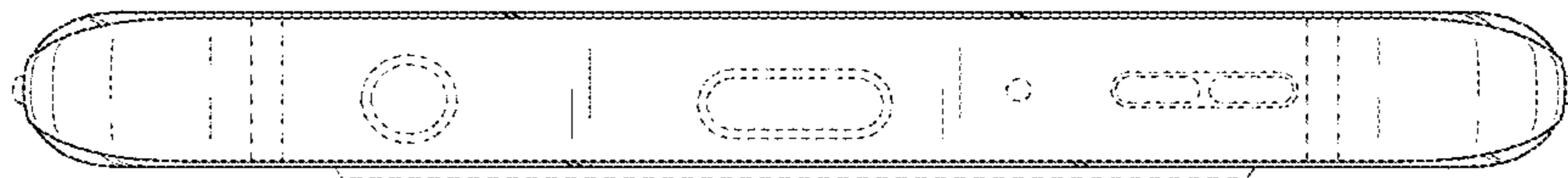

FIG. 32

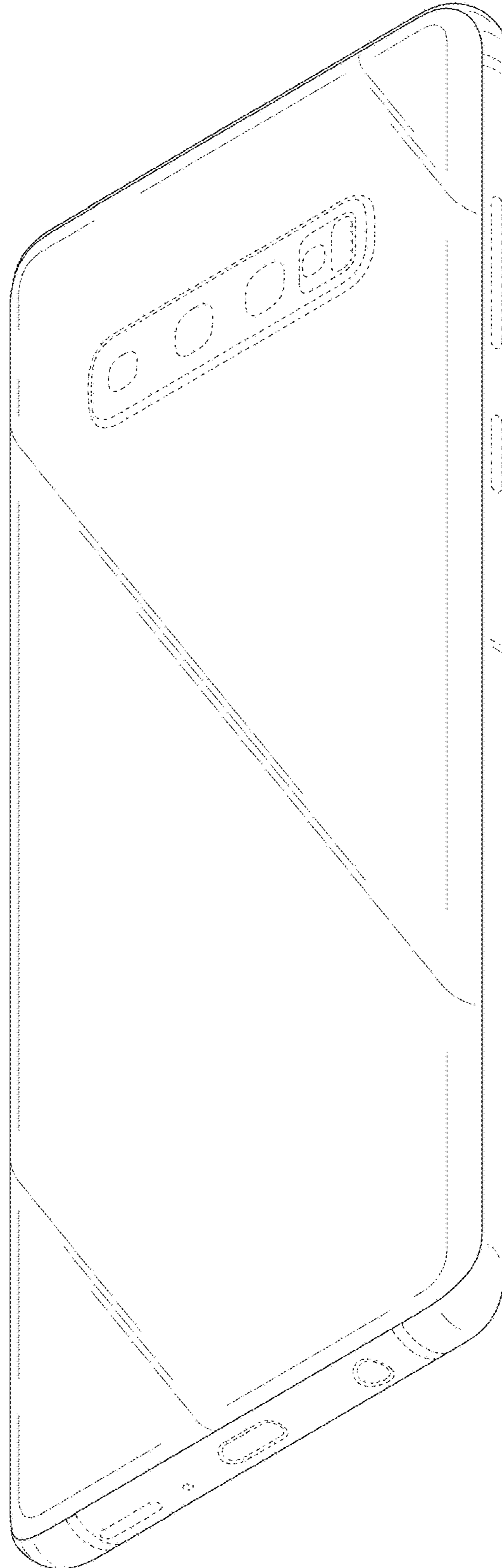

FIG. 33

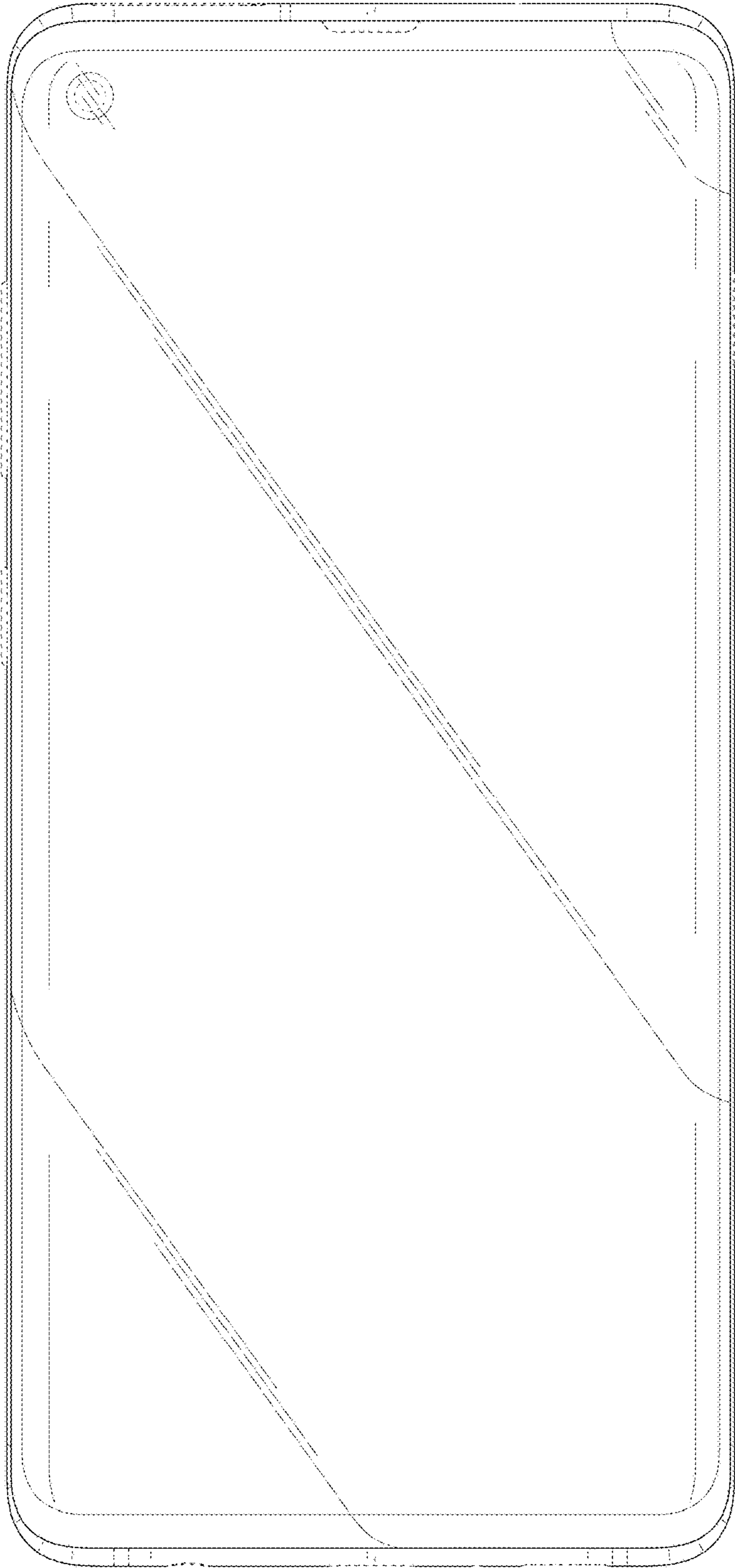

FIG. 34

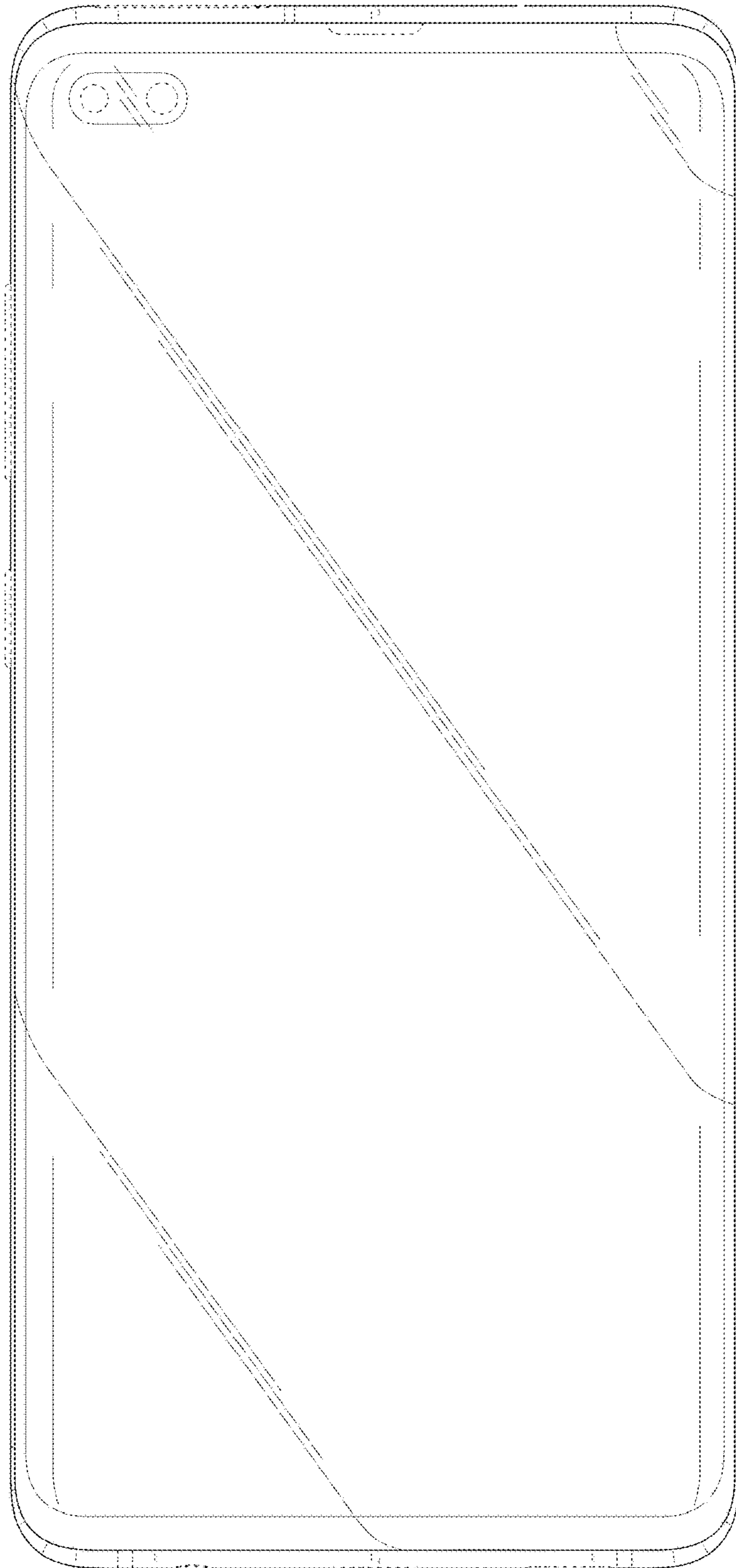

FIG. 35

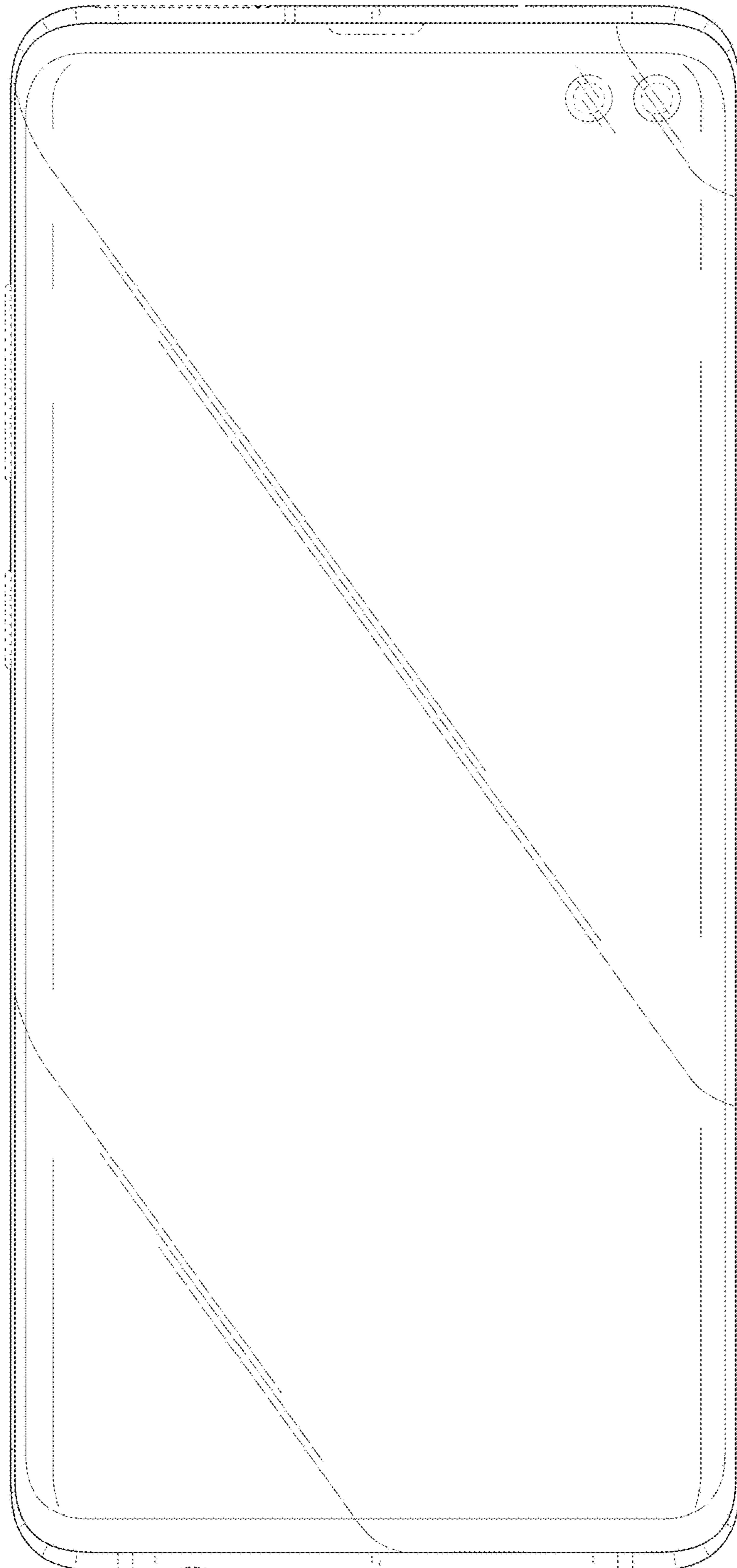

FIG. 36

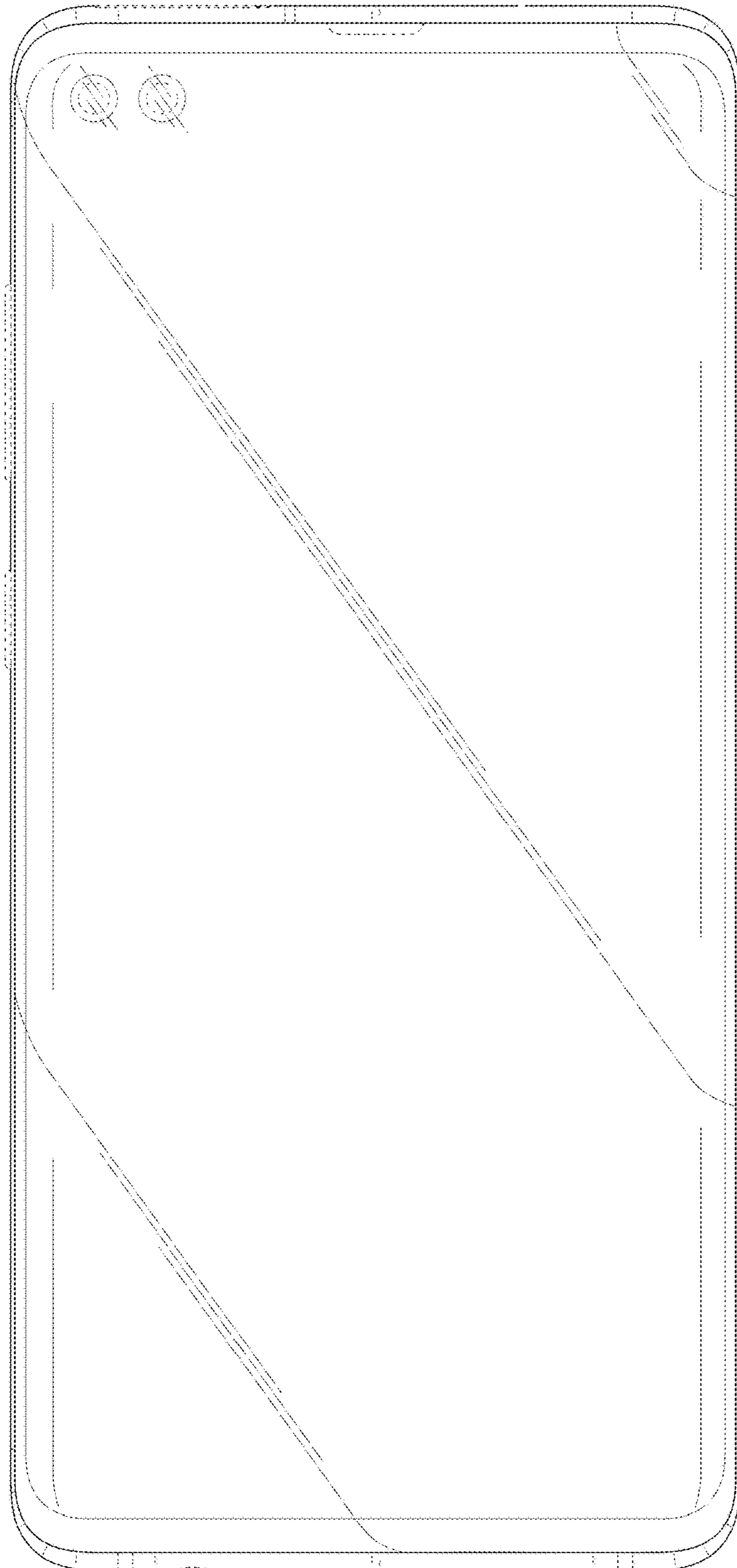

FIG. 37

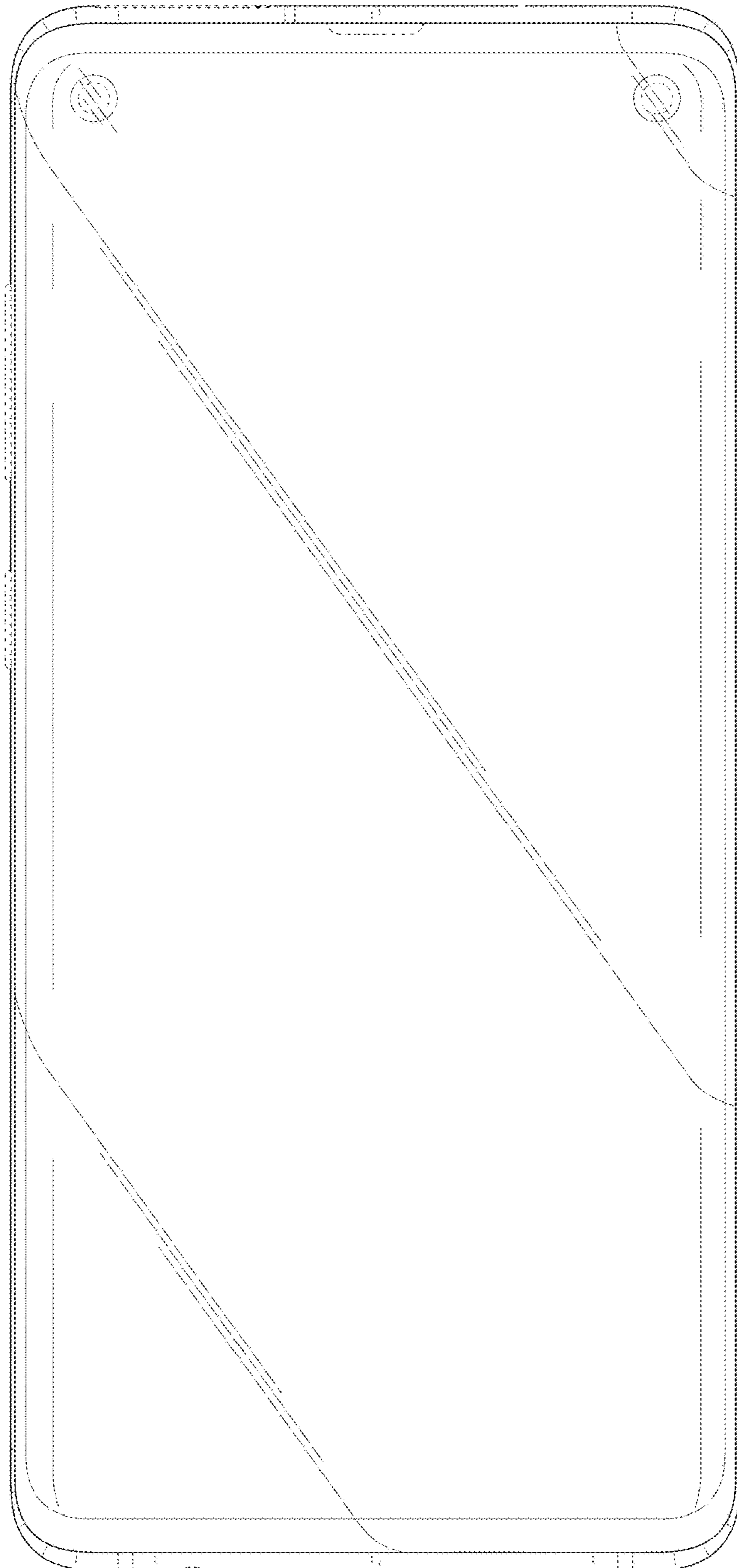

FIG. 38

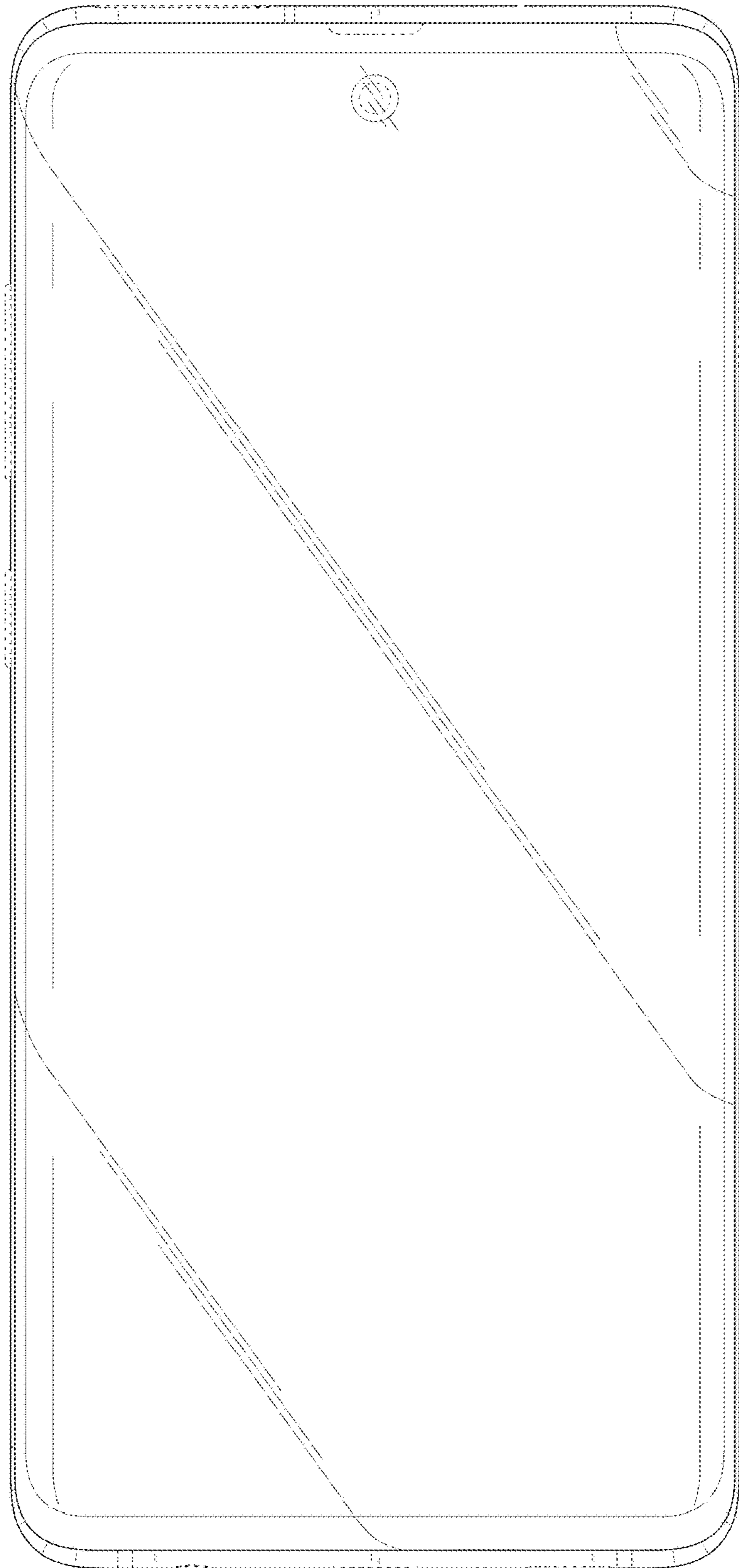

FIG. 39

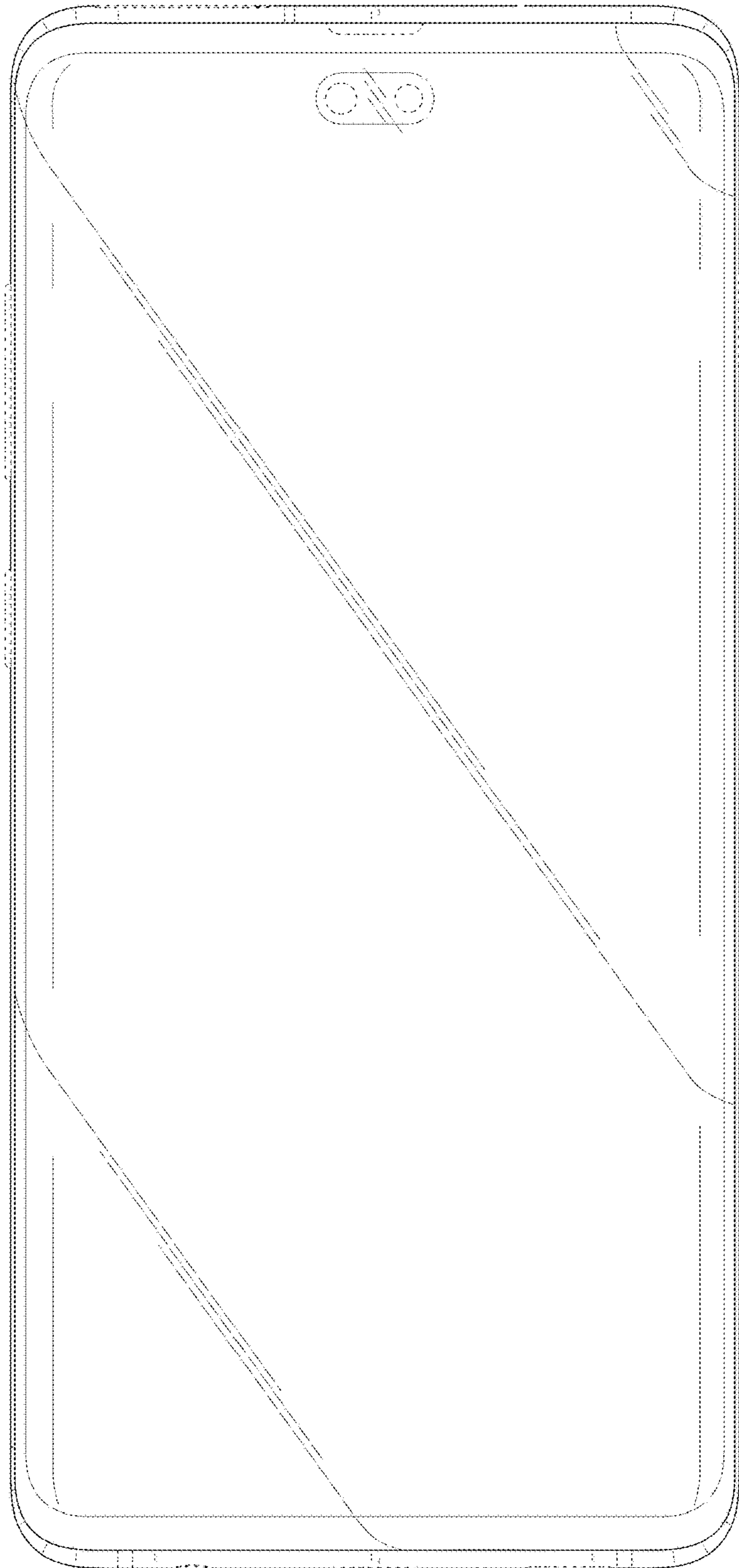

FIG. 40

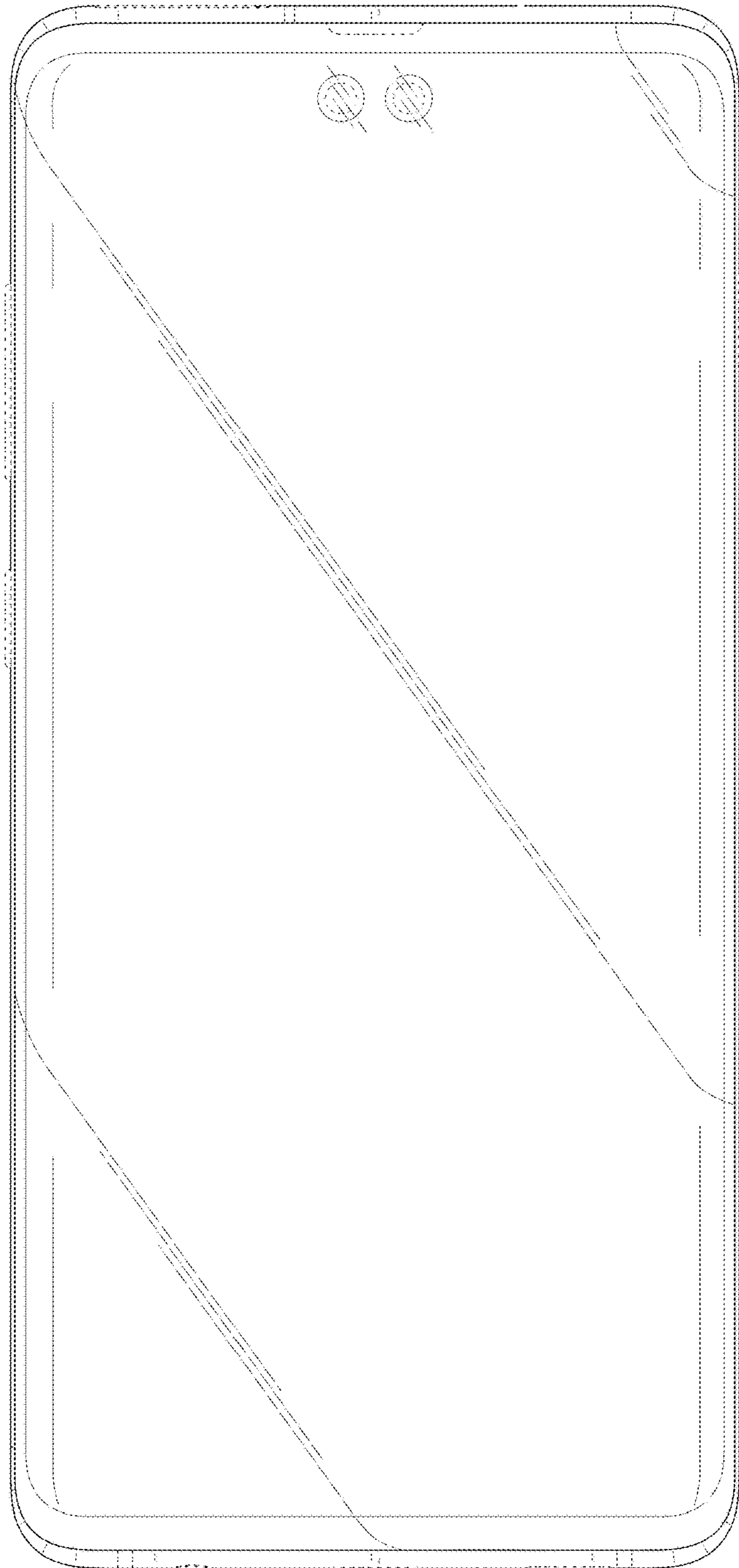

FIG. 41

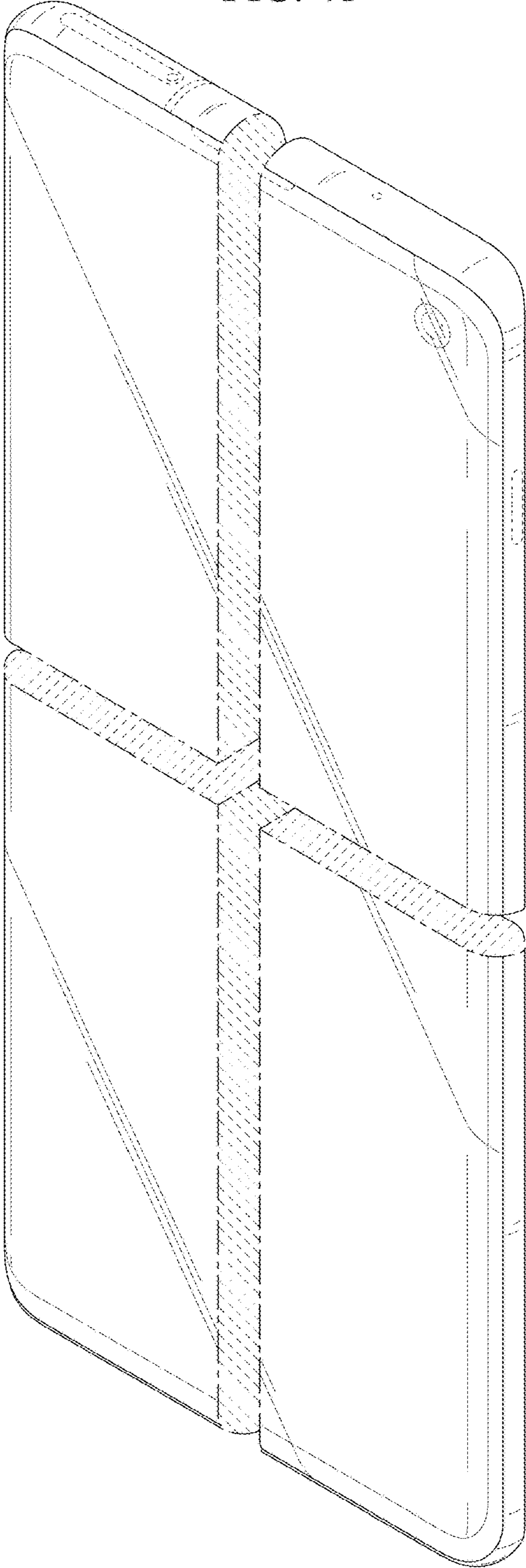

FIG. 42

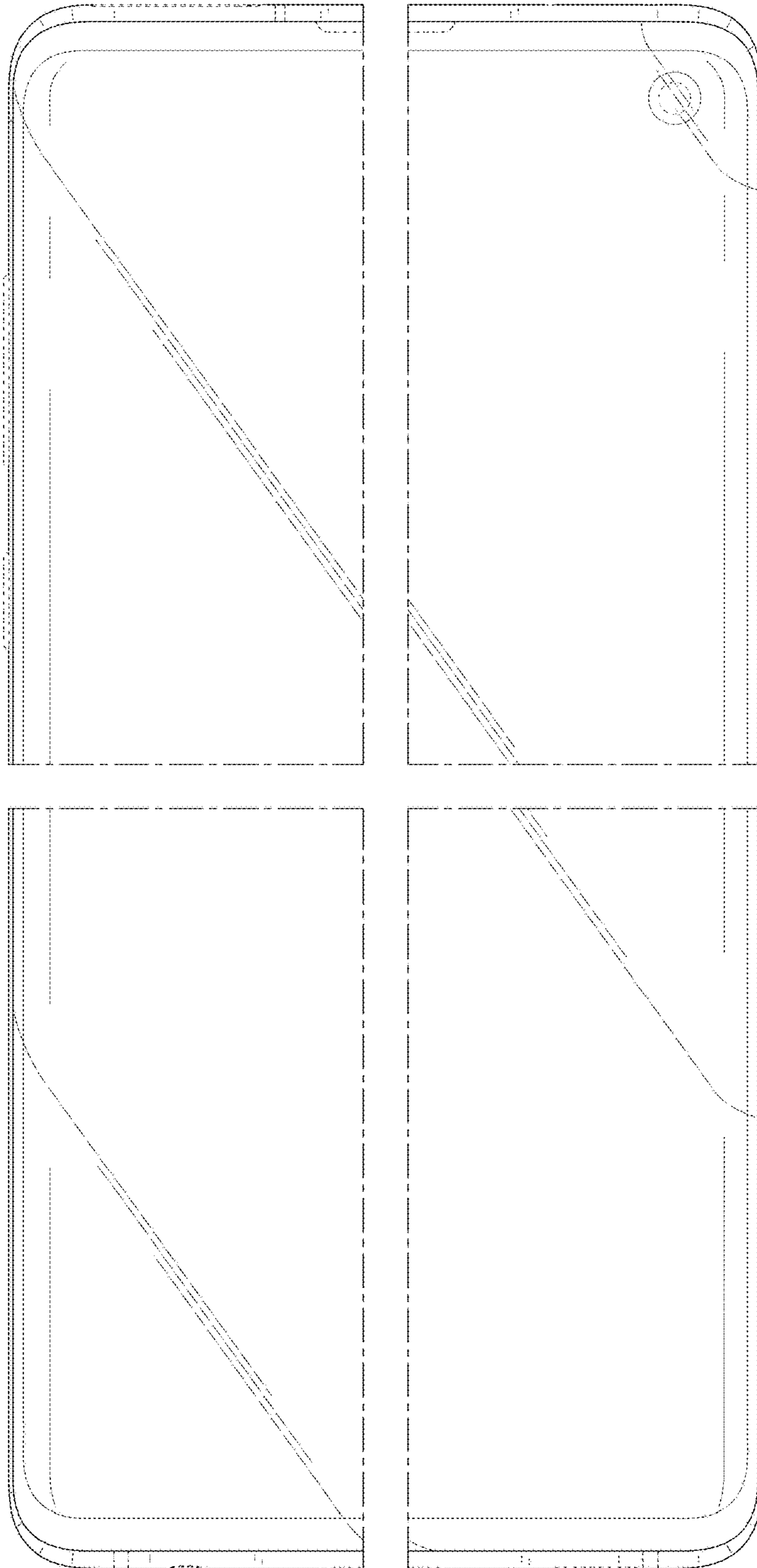

FIG. 43

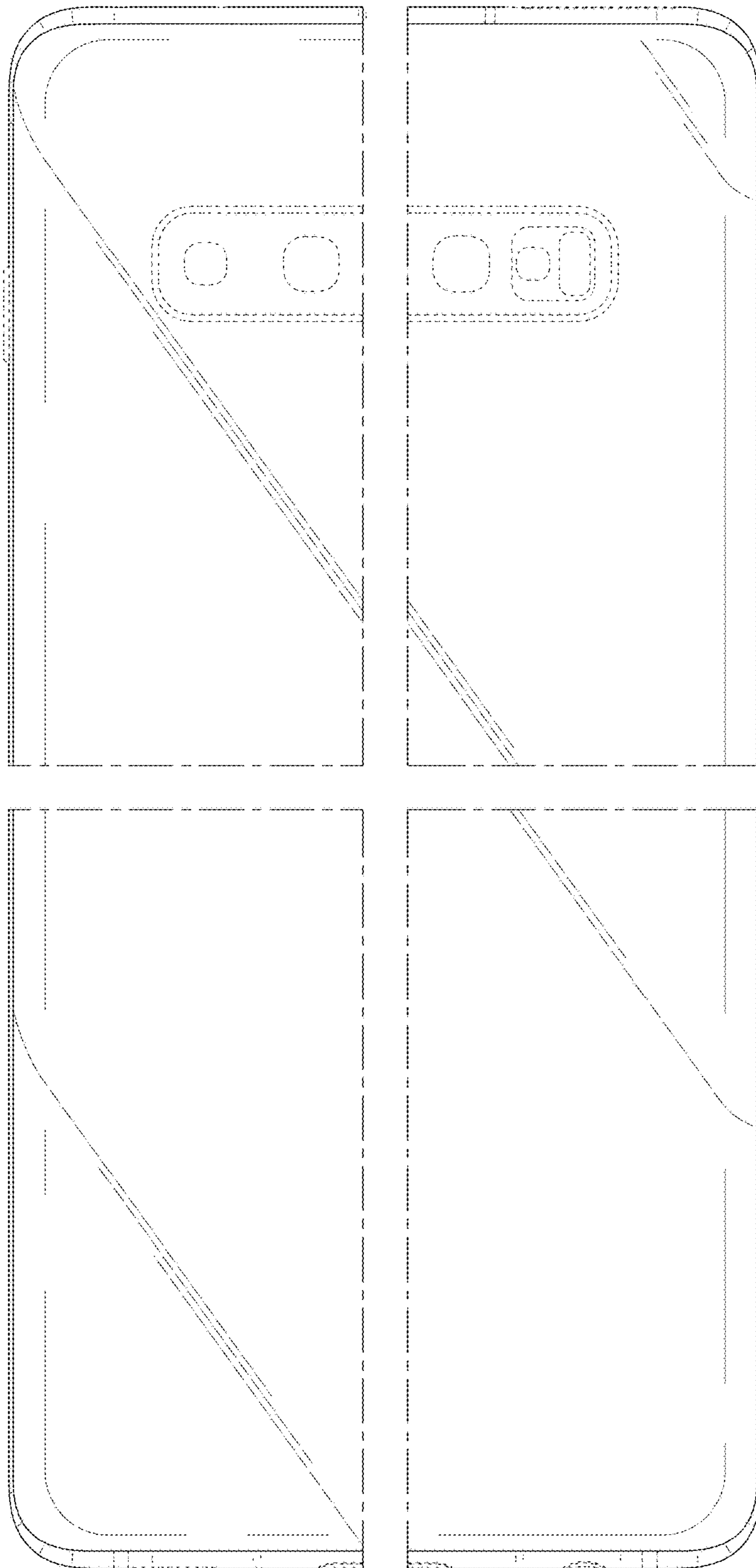

FIG. 44

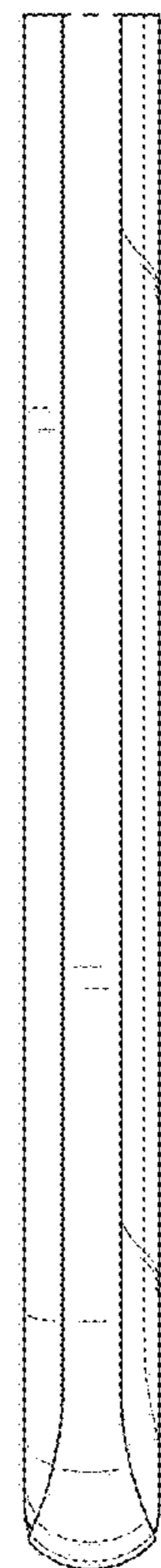
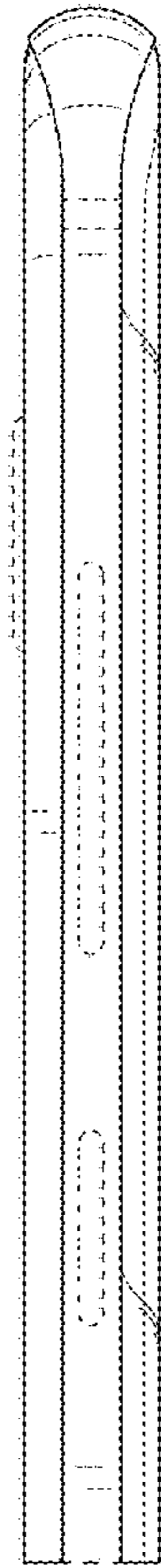

FIG. 45

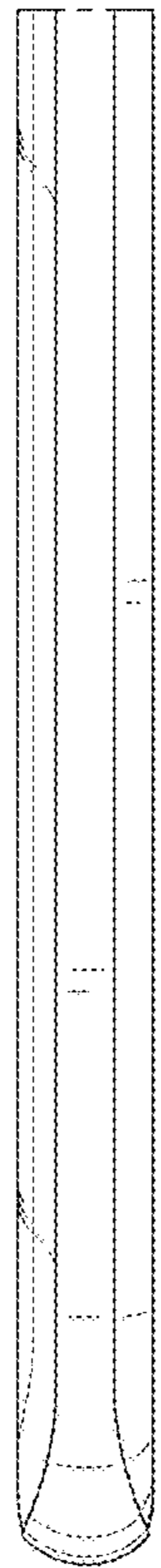

FIG. 46

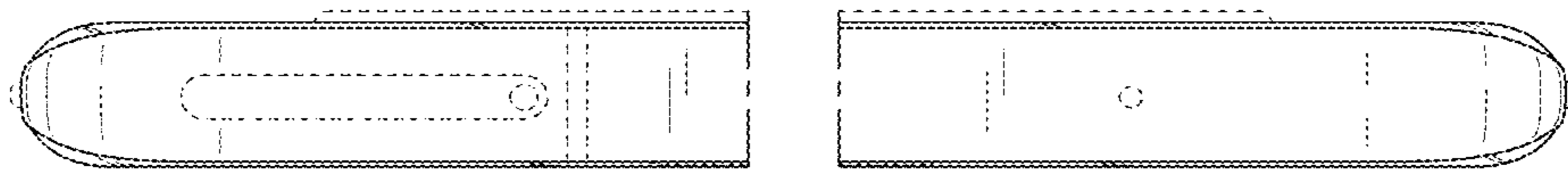

FIG. 47

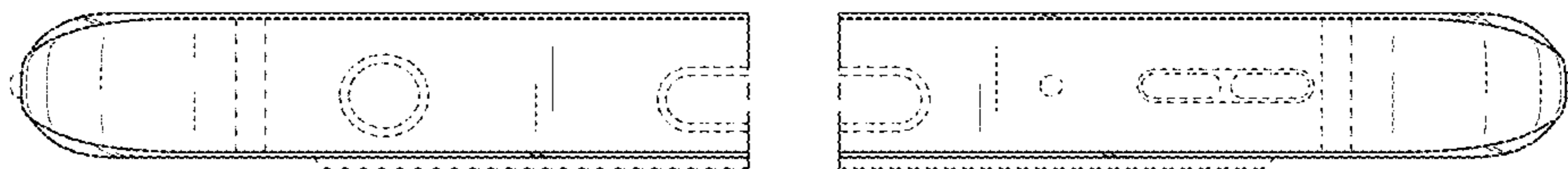

FIG. 48

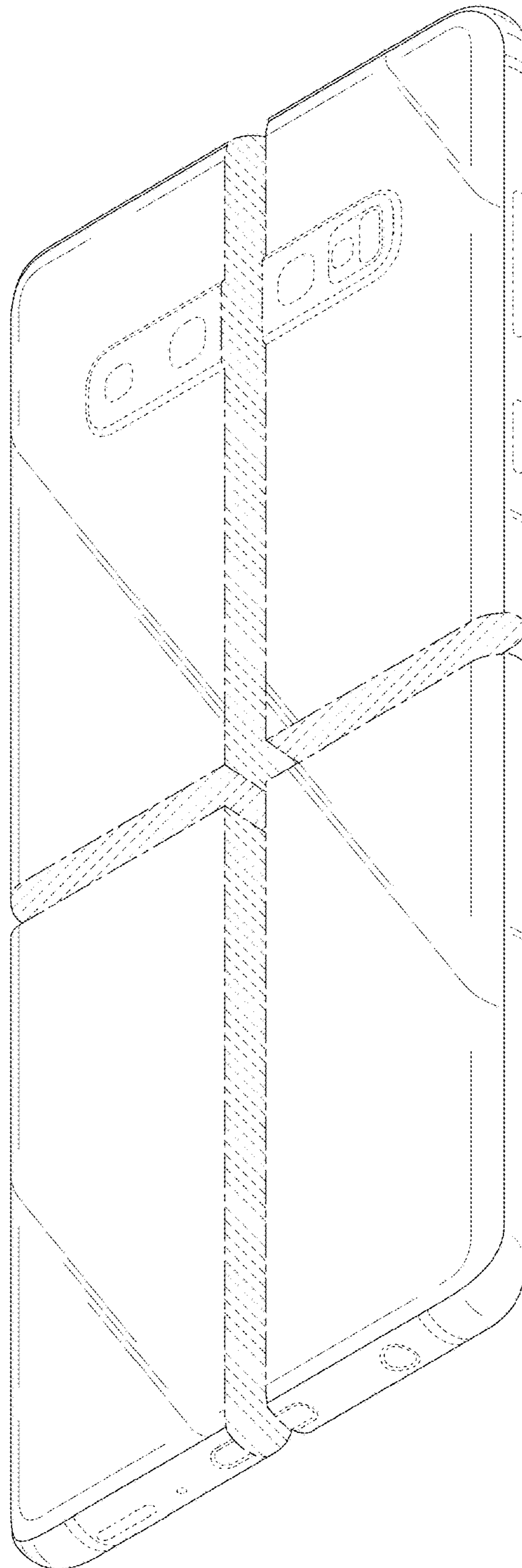

FIG. 49

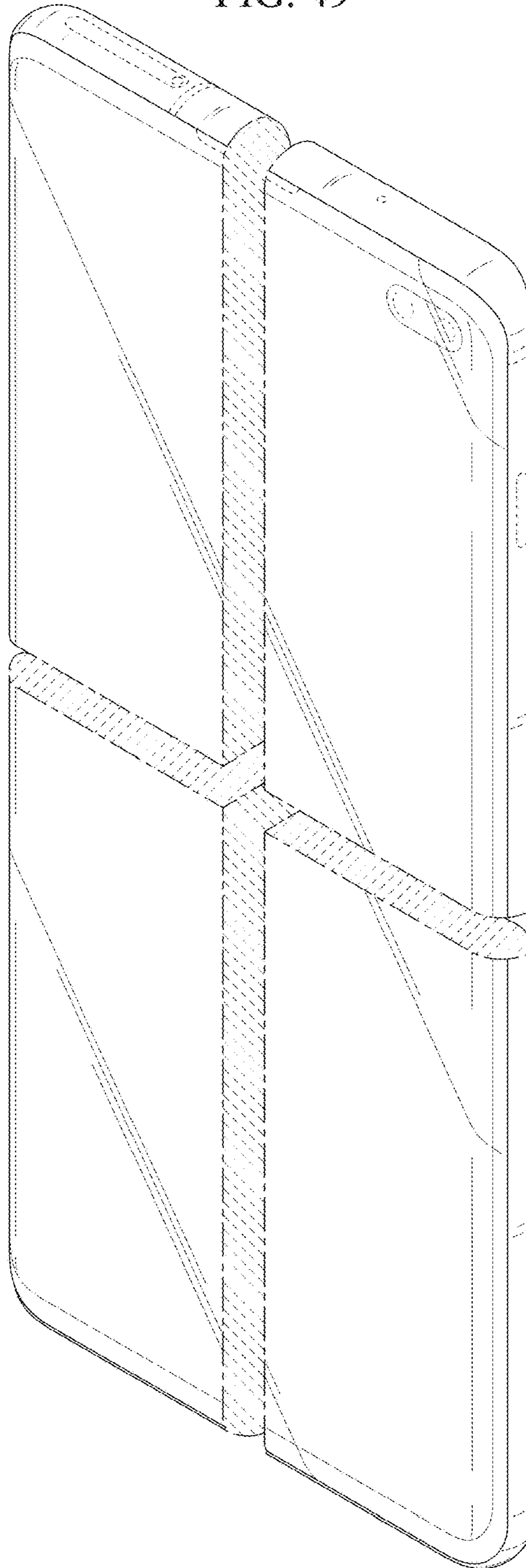

FIG. 50

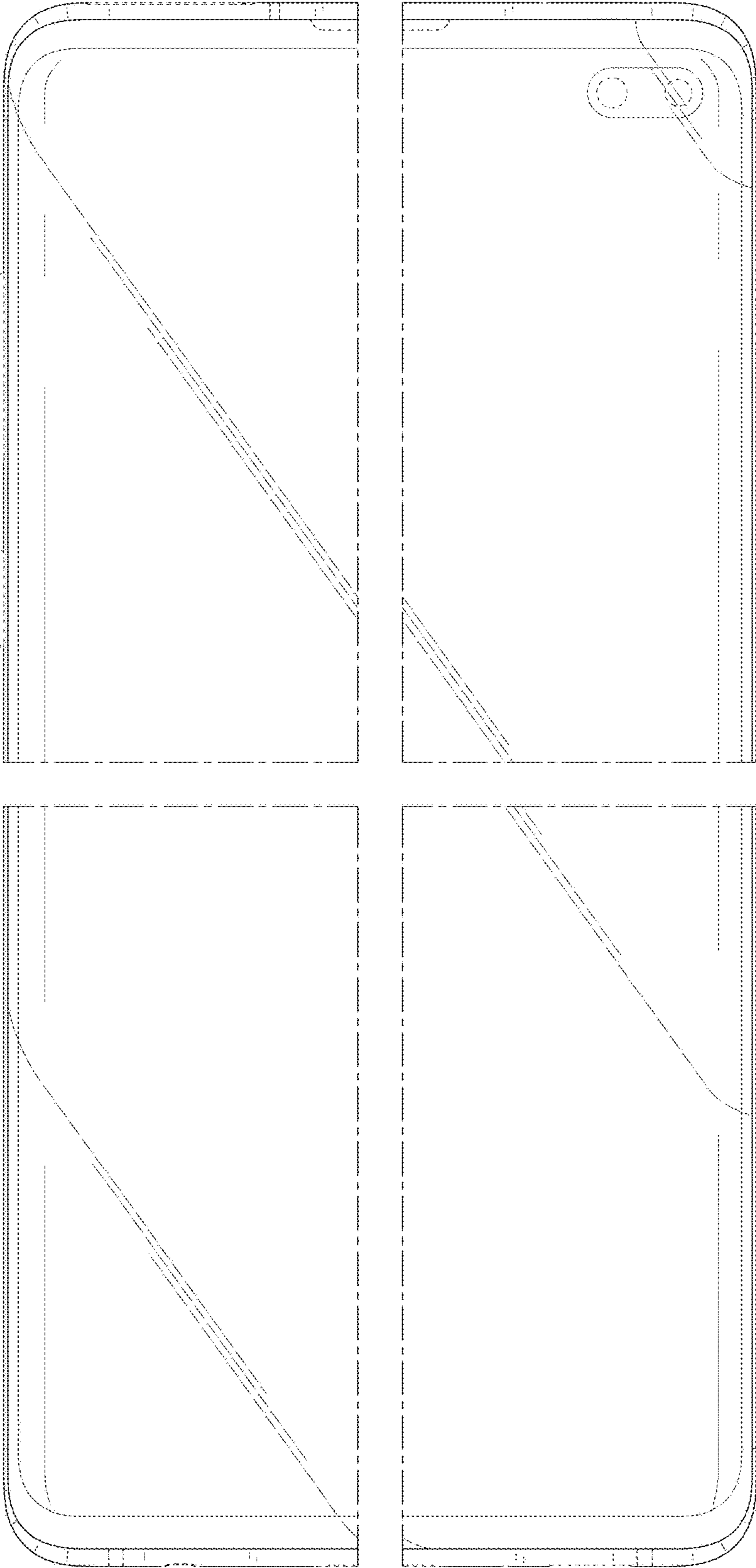

FIG. 51

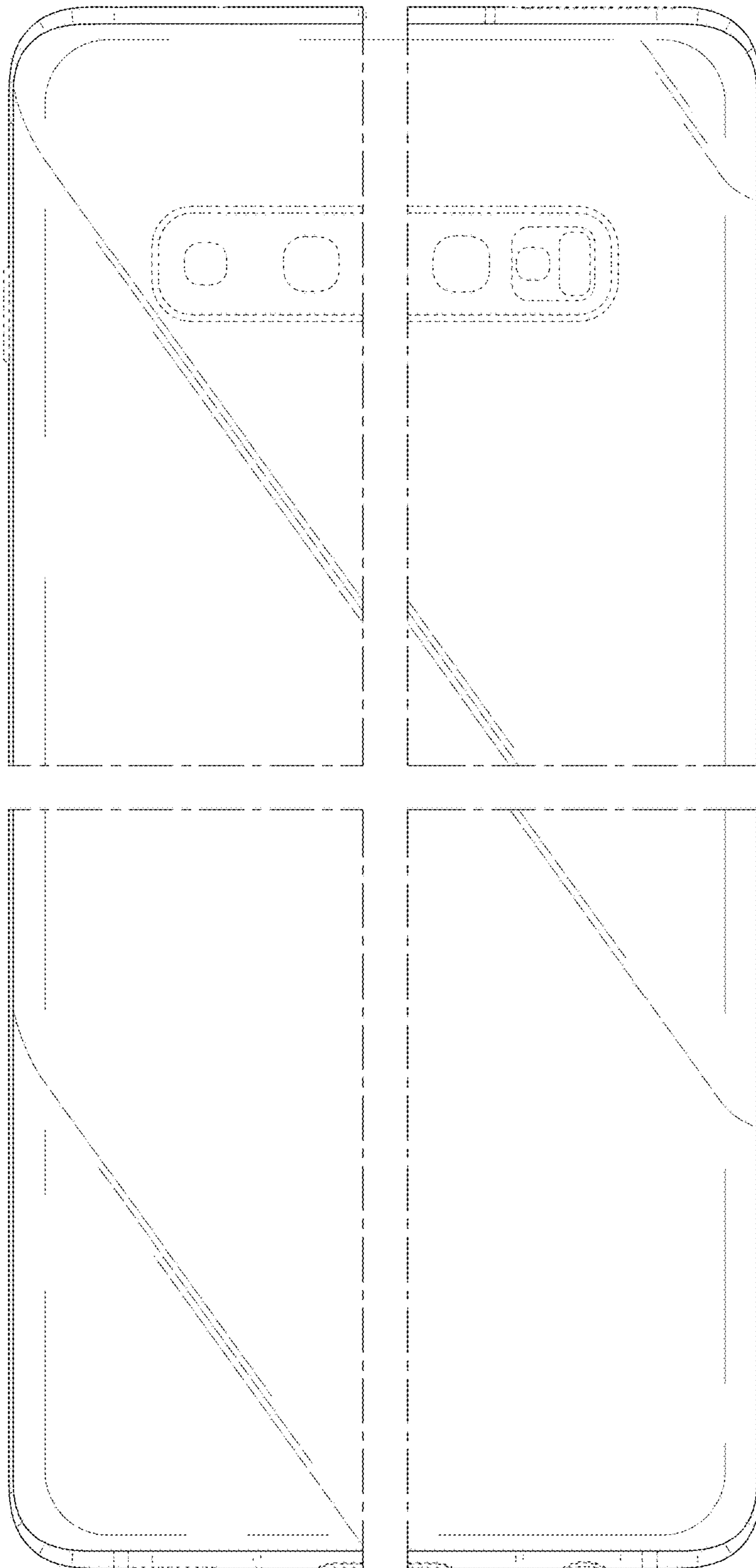

FIG. 52

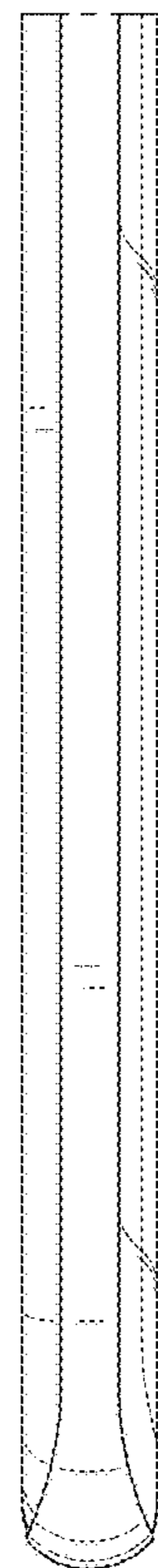
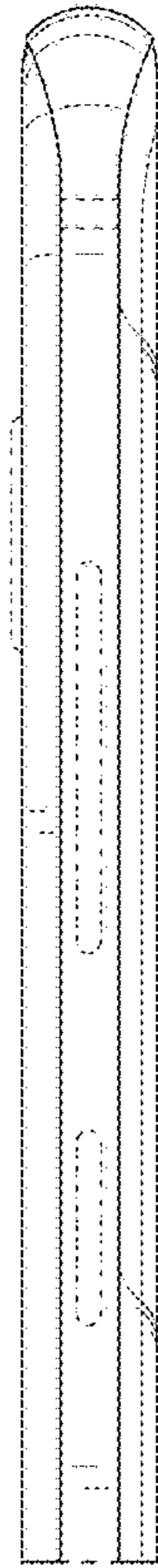

FIG. 53

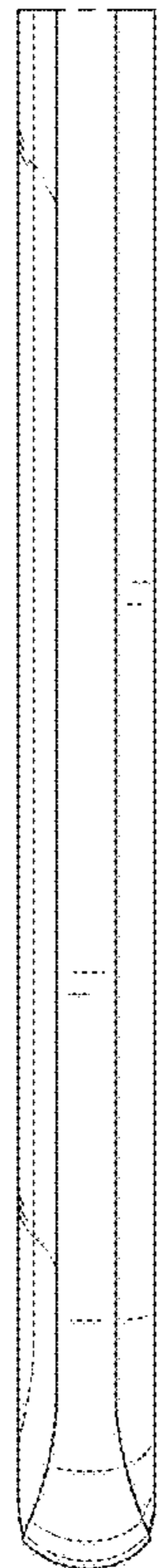

FIG. 54

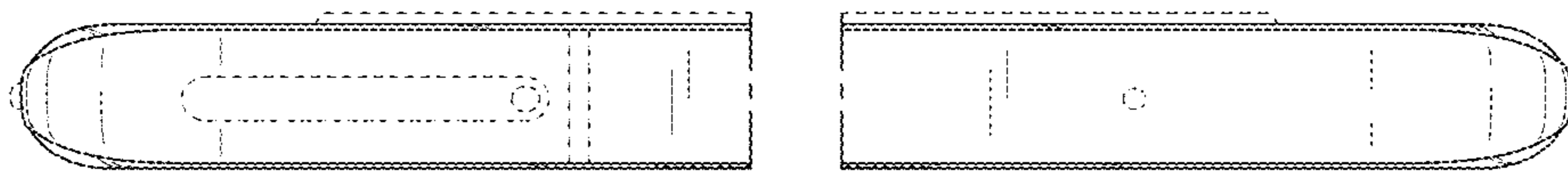

FIG. 55

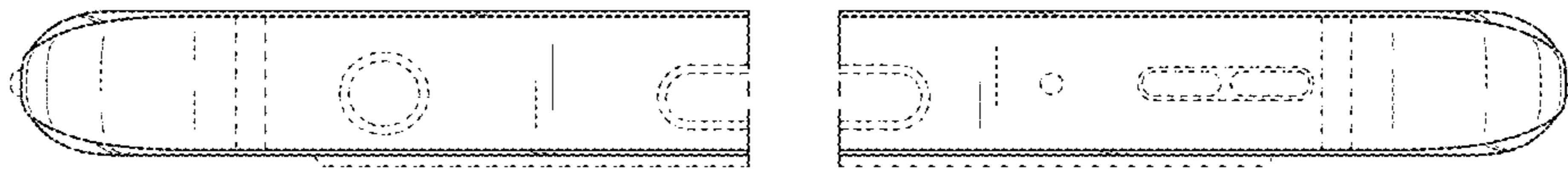

FIG. 56

