



US00D890076S

(12) **United States Design Patent**  
**Long et al.**

(10) **Patent No.:** **US D890,076 S**  
(45) **Date of Patent:** **\*\* Jul. 14, 2020**

(54) **ATTENDANT MODULE**

(71) Applicant: **The Boeing Company**, Chicago, IL (US)

(72) Inventors: **Stephen R. Long**, Snohomish, WA (US); **Roland D. Mair**, Kenmore, WA (US); **Russell Warren Keck**, Seattle, WA (US); **Robert Benjamin Lanfear**, Kingston, WA (US); **Paul Bridgeman**, Bothell, WA (US)

(73) Assignee: **The Boeing Company**, Chicago, IL (US)

(\*\*) Term: **15 Years**

(21) Appl. No.: **29/698,992**

(22) Filed: **Jul. 22, 2019**

**Related U.S. Application Data**

(63) Continuation of application No. 29/619,622, filed on Sep. 29, 2017, now Pat. No. Des. 860,110.

(51) **LOC (12) Cl.** ..... **12-07**

(52) **U.S. Cl.**  
USPC ..... **D12/345; D13/162**

(58) **Field of Classification Search**  
USPC ..... D13/107, 156, 162, 184; D14/240;  
D10/104.1, 106.95; D12/192, 195, 345,  
D12/415, 423, 425

(Continued)

(56) **References Cited**

**U.S. PATENT DOCUMENTS**

4,913,487 A 4/1990 Breckel et al.

5,907,127 A 5/1999 Daoud

(Continued)

**OTHER PUBLICATIONS**

United States Patent and Trademark Office, "Notice of Allowance and Fee(s) Due," issued in connection with U.S. Appl. No. 29/619,618, dated Dec. 28, 2018, 20 pages.

(Continued)

*Primary Examiner* — Selina Sikder

(74) *Attorney, Agent, or Firm* — Hanley, Flight & Zimmerman, LLC

(57) **CLAIM**

The ornamental design for an attendant module, as shown and described in FIGS. 1-20.

**DESCRIPTION**

FIG. 1 is a front, right perspective view of an example attendant module.

FIG. 2 is a front view of the attendant module of FIG. 1.

FIG. 3 is a rear view of the attendant module of FIG. 1.

FIG. 4 is left side view of the attendant module of FIG. 1.

FIG. 5 is a right side view of the attendant module of FIG. 1.

FIG. 6 is a top view of the attendant module of FIG. 1.

FIG. 7 is a bottom view of the attendant module of FIG. 1.

FIG. 8 is a front, right perspective view of another example attendant module.

FIG. 9 is a front view of the attendant module of FIG. 8.

FIG. 10 is a rear view of the attendant module of FIG. 8.

FIG. 11 is left side view of the attendant module of FIG. 8.

FIG. 12 is a right side view of the attendant module of FIG. 8.

FIG. 13 is a top view of the attendant module of FIG. 8.

FIG. 14 is a bottom view of the attendant module of FIG. 8.

FIG. 15 is a perspective view of the example attendant module of FIGS. 1-7 shown inside a fuselage of an aircraft. FIG. 16 is an enlarged view of the example attendant module of FIG. 15 and an enlarged view of an overhead module of the fuselage of the aircraft positioned adjacent the attendant module.

FIG. 17 is another enlarged view showing portions of the attendant module and the overhead module of FIGS. 15 and 16. FIG. 17 also illustrates a recessed cavity in a ceiling of the fuselage of the aircraft of FIG. 15 positioned adjacent an upper end of the attendant module.

FIG. 18 is another view of the upper portion of the attendant module and the recessed ceiling portion of FIG. 17.

FIG. 19 is a front, partial perspective view of the attendant module and an attendant seat of the fuselage of FIG. 15; and,

(Continued)

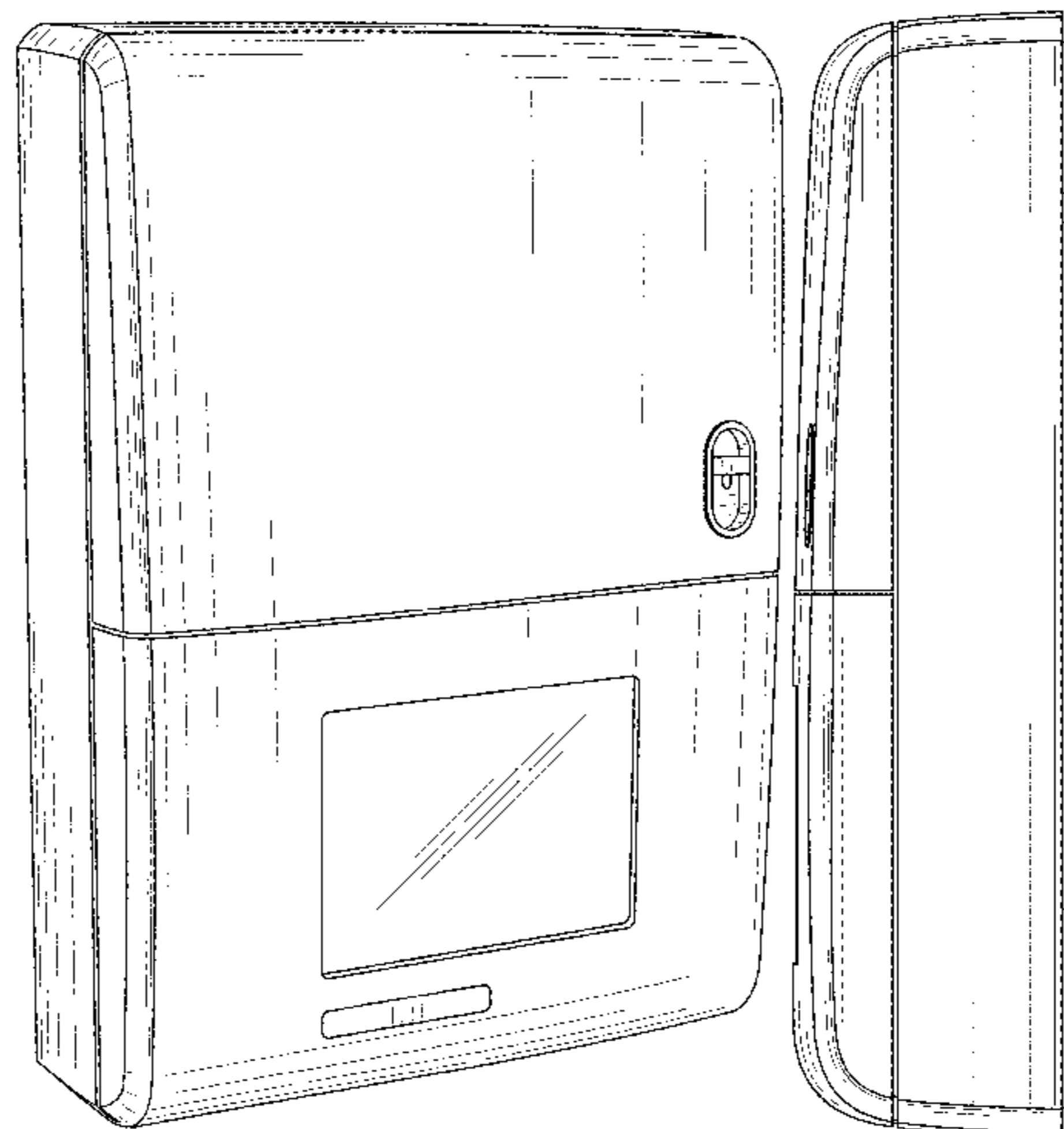

FIG. 20 is a side view of the attendant module and the attendant seat of FIG. 19.

The features shown in broken lines form no part of the claimed design.

**1 Claim, 16 Drawing Sheets**

**(58) Field of Classification Search**

CPC ..... B64D 11/00; B64D 11/04; B64D 11/06;  
 B64D 11/0629; B64D 11/0691; B64D  
 2011/0092; B64C 1/14; H05K 5/0221;  
 H05K 5/0226

See application file for complete search history.

**(56) References Cited**

**U.S. PATENT DOCUMENTS**

D438,532 S	3/2001	Gargani et al.	
D604,254 S	11/2009	Lanfear et al.	
D610,554 S	2/2010	Lanfear et al.	
D611,005 S	3/2010	Lanfear et al.	
D611,006 S	3/2010	Lanfear et al.	
D615,045 S	5/2010	Lanfear et al.	
D624,915 S	10/2010	Ferreira Sanchez	
D631,446 S	1/2011	Lanfear et al.	
D634,698 S	3/2011	Saint-Jalmes et al.	
D654,496 S	2/2012	Chen et al.	
D669,440 S	10/2012	Wu	
D709,854 S	7/2014	Pan	
8,820,862 B1	9/2014	Erickson et al.	
D719,862 S	12/2014	Fiedler et al.	
D736,716 S	8/2015	Hough et al.	
9,321,533 B2 *	4/2016	Cuddy .....	B64D 47/02
D774,003 S	12/2016	Lee et al.	

9,580,176 B2	2/2017	Ehlers et al.	
D784,905 S	4/2017	Savian et al.	
D813,212 S	3/2018	Nangeroni et al.	
D826,223 S	8/2018	Cho et al.	
D827,453 S	9/2018	Davoli	
D830,969 S	10/2018	Wang et al.	
D834,499 S	11/2018	Nixon	
D843,331 S *	3/2019	Long .....	D13/162
D848,348 S *	5/2019	Long .....	D12/345
D860,110 S *	9/2019	Long .....	D12/345
2018/0048132 A1	2/2018	Dinh et al.	

**OTHER PUBLICATIONS**

United States Patent and Trademark Office, "Notice of Allowance and Fee(s) Due," issued in connection with U.S. Appl. No. 29/619,619, dated Oct. 17, 2018, 17 pages.

United States Patent and Trademark Office, "Notice of Allowance and Fee(s) Due," issued in connection with U.S. Appl. No. 29/619,622, dated Apr. 24, 2019, 16 pages.

United States Patent and Trademark Office, "Non-Final Office Action," issued in connection with U.S. Appl. No. 29/619,622, dated Dec. 6, 2018, 14 pages.

United States Patent and Trademark Office, "Non-Final Office Action," issued in connection with U.S. Appl. No. 29/663,821, dated Apr. 1, 2020, 3 pages.

United States Patent and Trademark Office, "Non-Final Office Action," issued in connection with U.S. Appl. No. 29/663,822, dated Apr. 1, 2020, 3 pages.

United States Patent and Trademark Office, "Notice of Allowance and Fee(s) Due," issued in connection with U.S. Appl. No. 29/683,479, dated Mar. 6, 2020, 6 pages.

United States Patent and Trademark Office, "Final Office Action," issued in connection with U.S. Appl. No. 29/663,820, dated Apr. 28, 2020, 6 pages.

\* cited by examiner

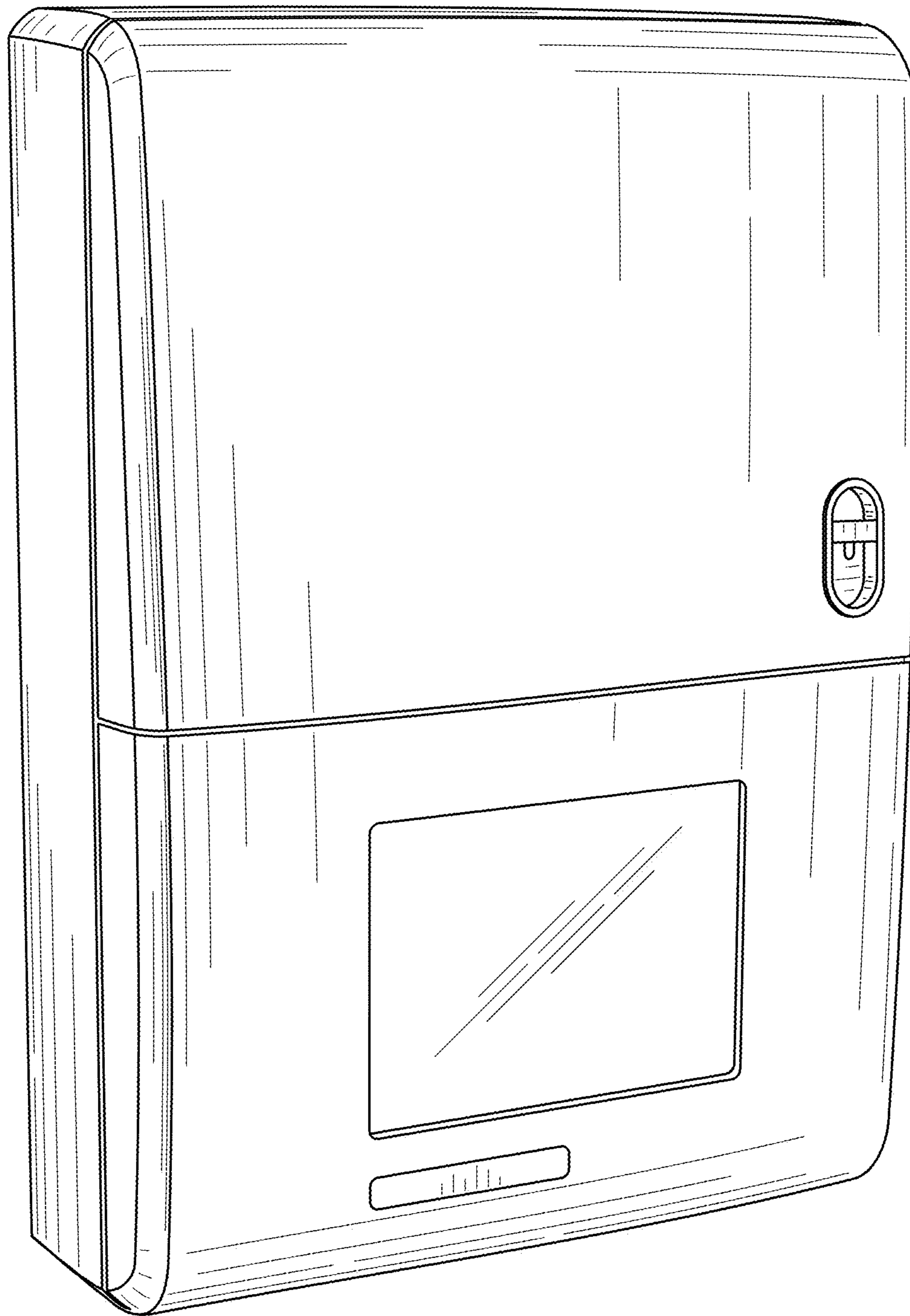

FIG. 1



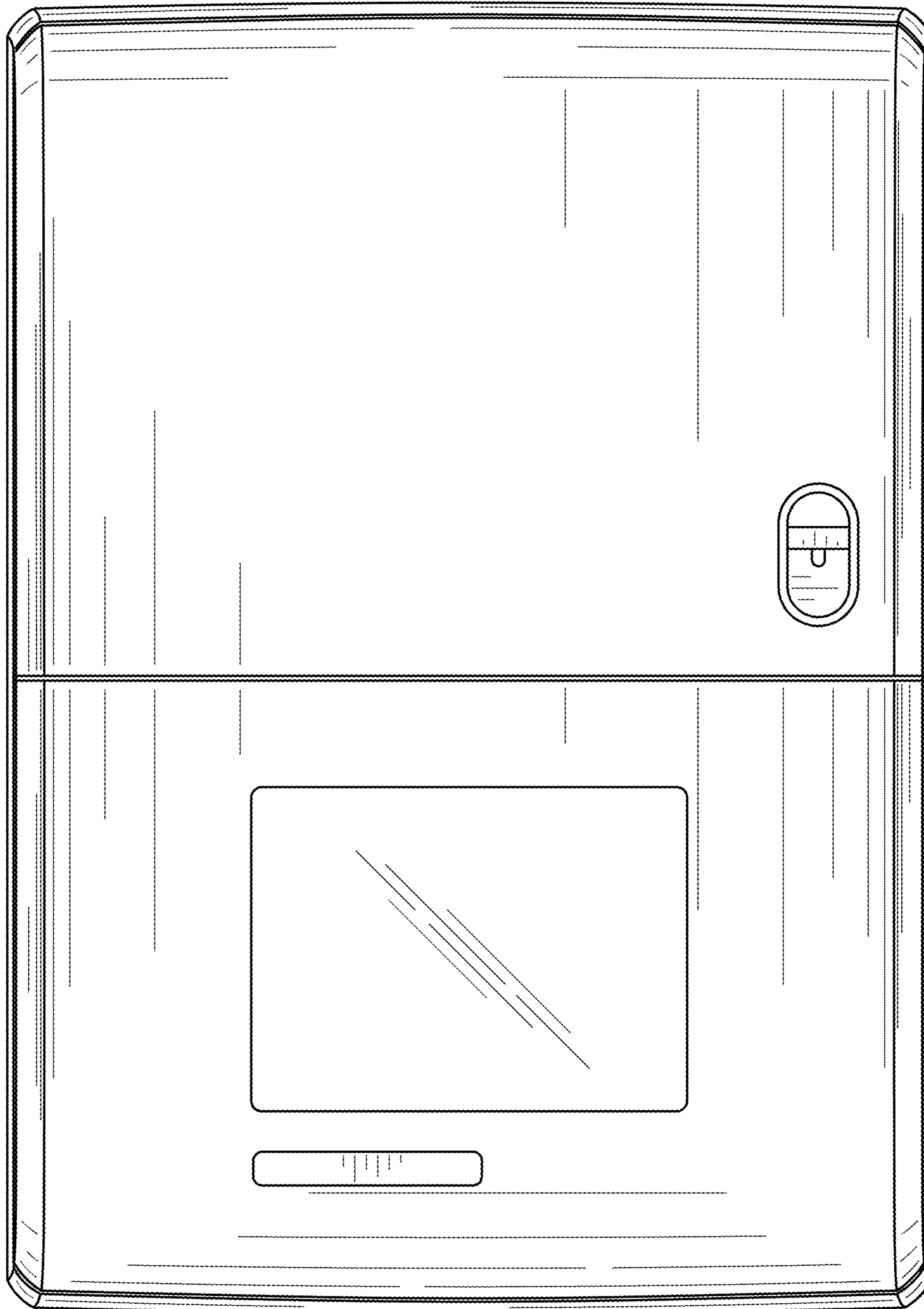

FIG. 2

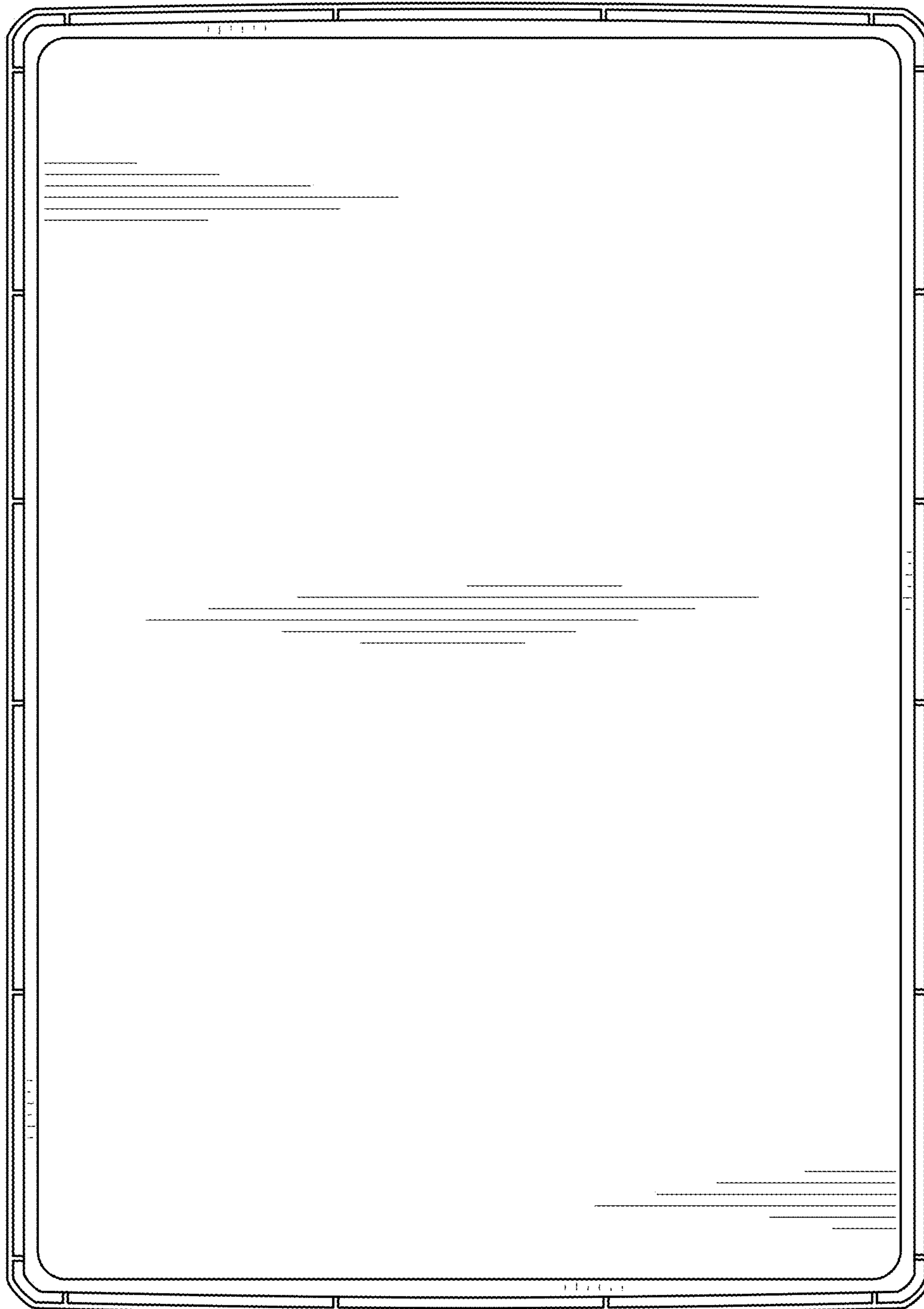

FIG. 3

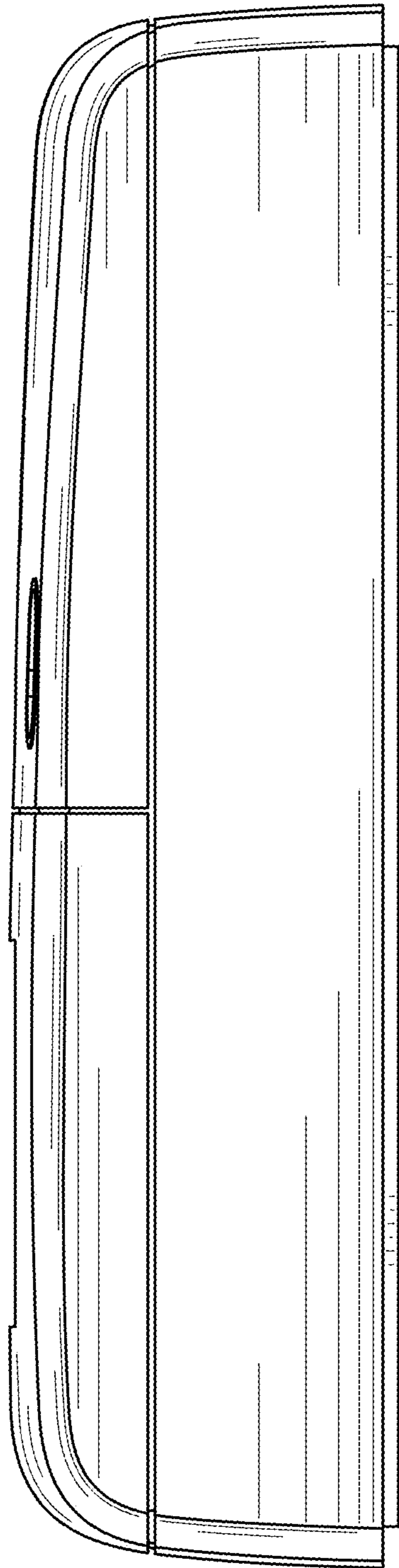

FIG. 4

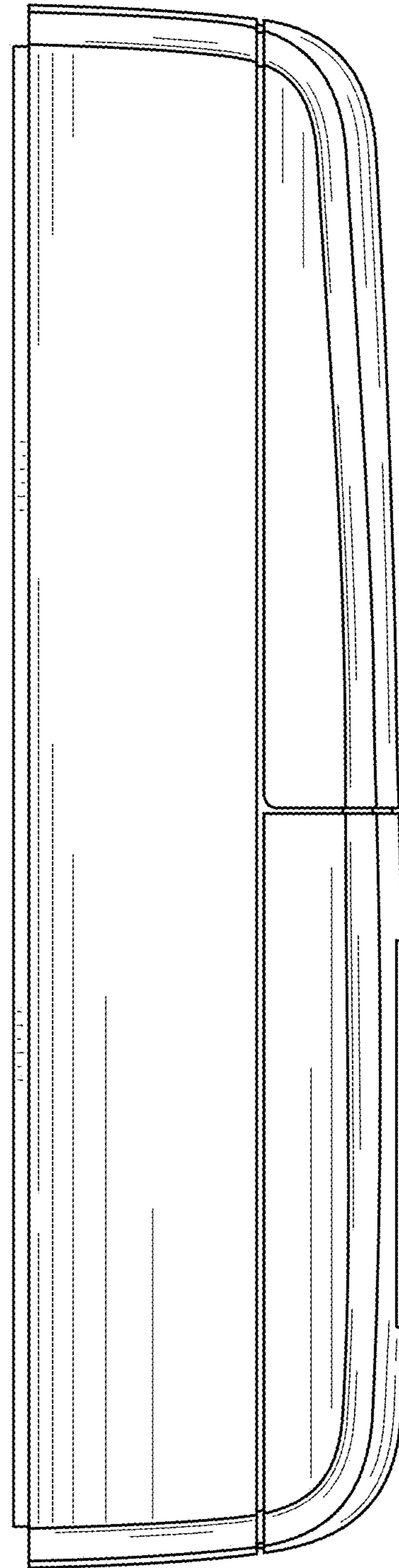

FIG. 5

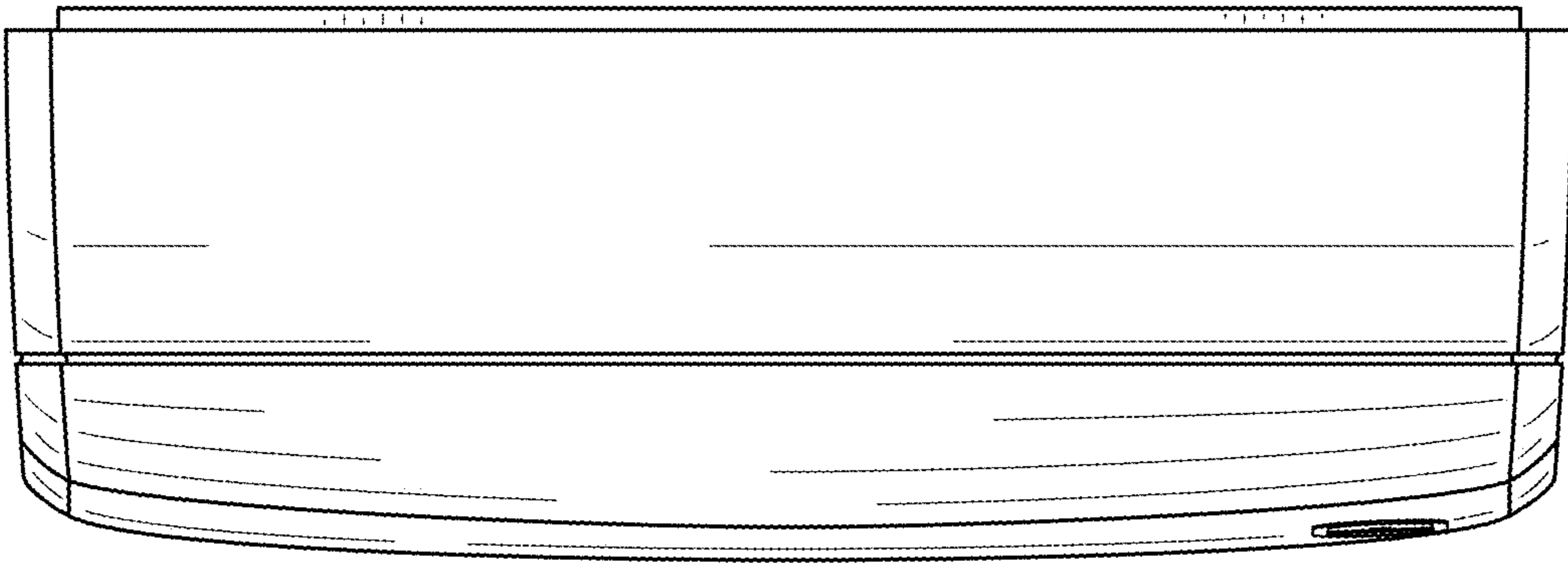

FIG. 6

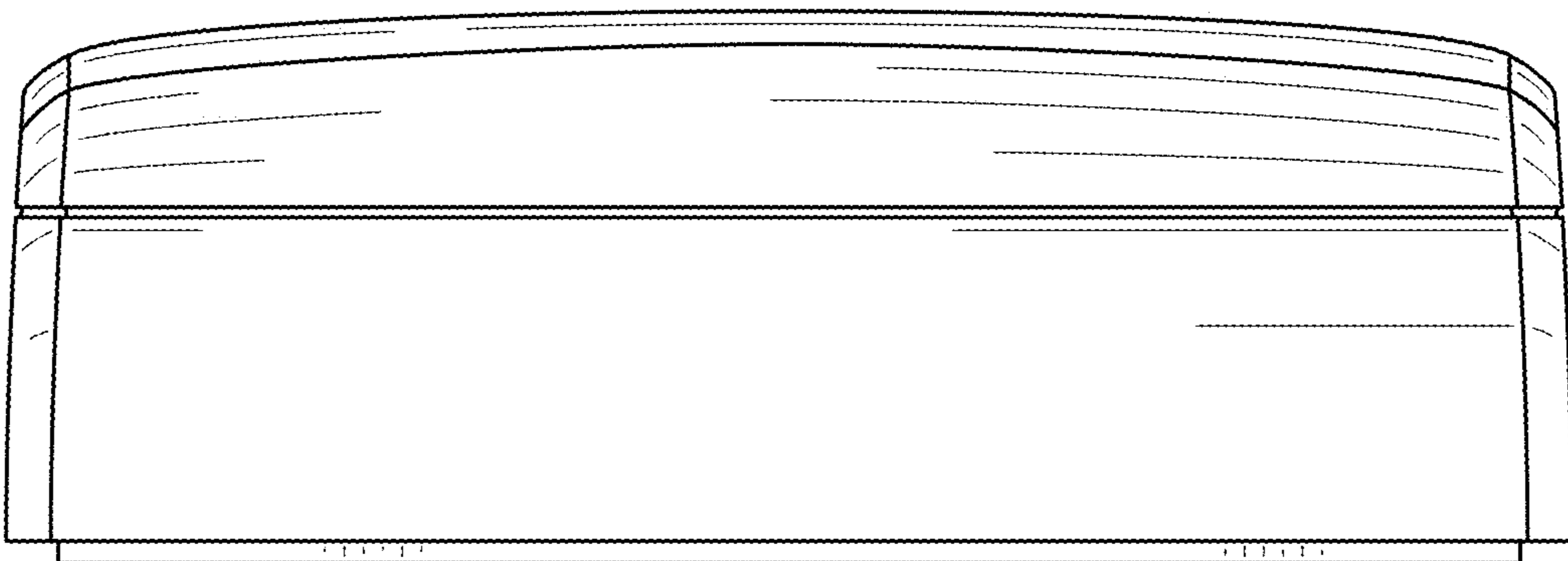

FIG. 7

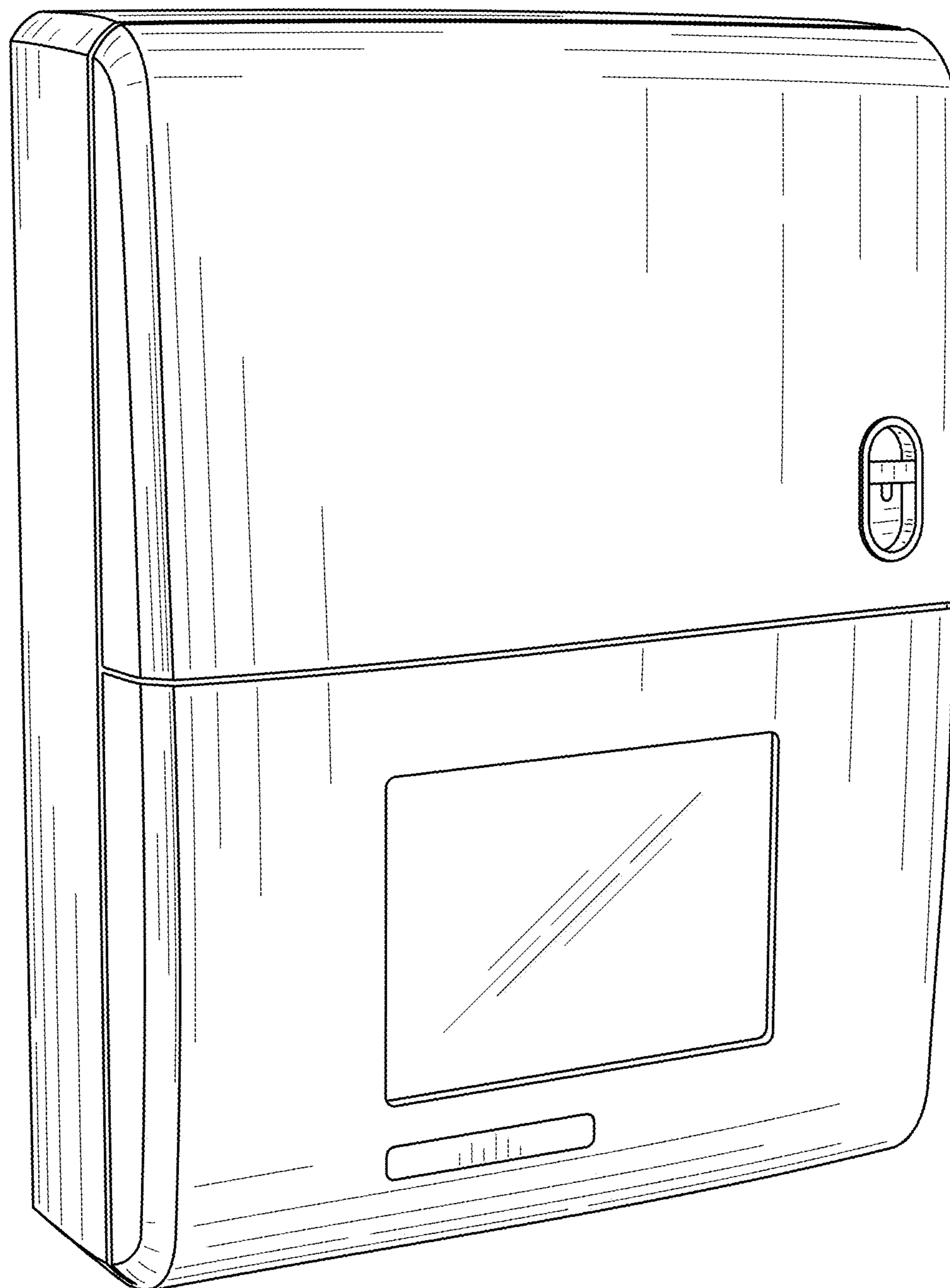

FIG. 8



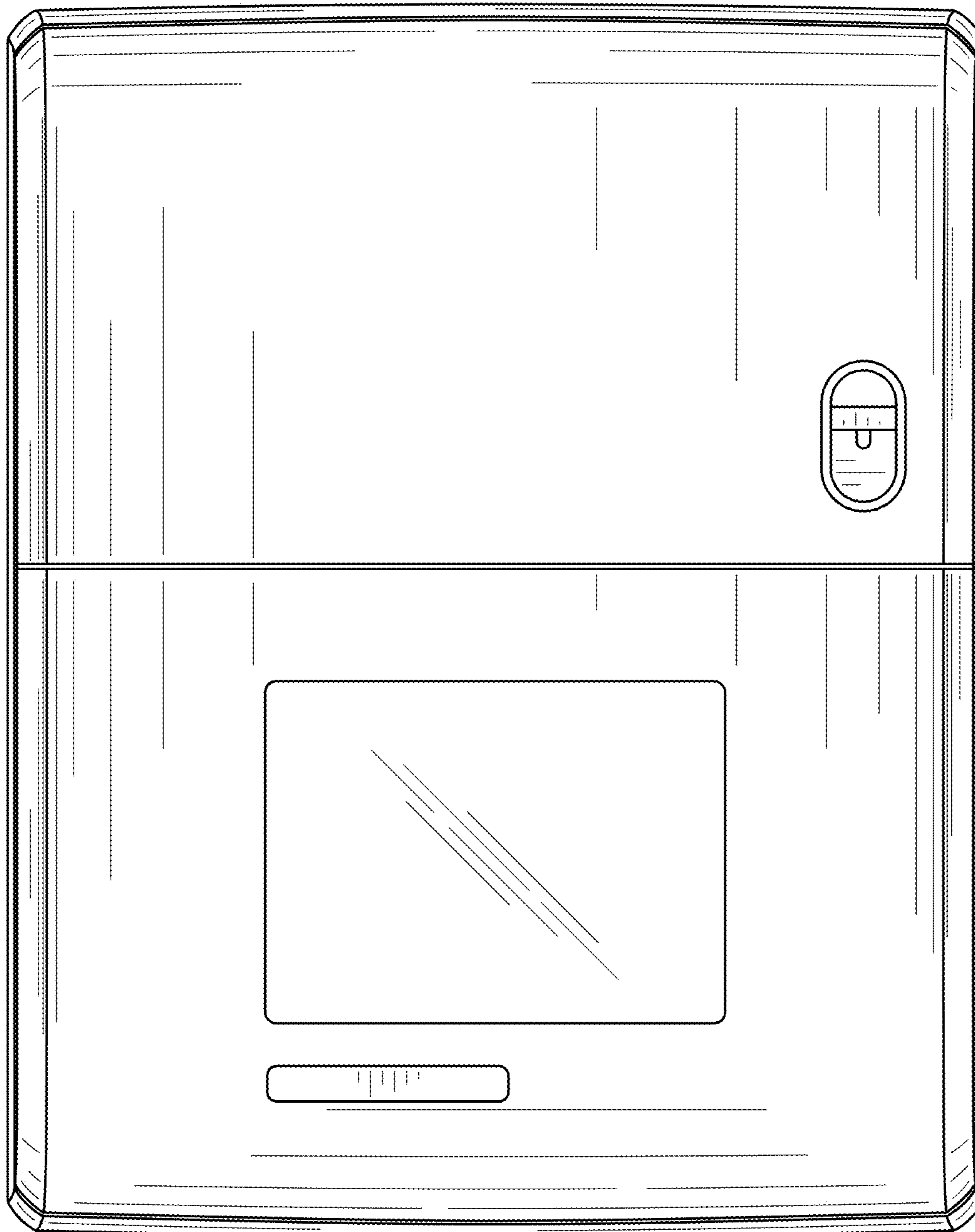

FIG. 9

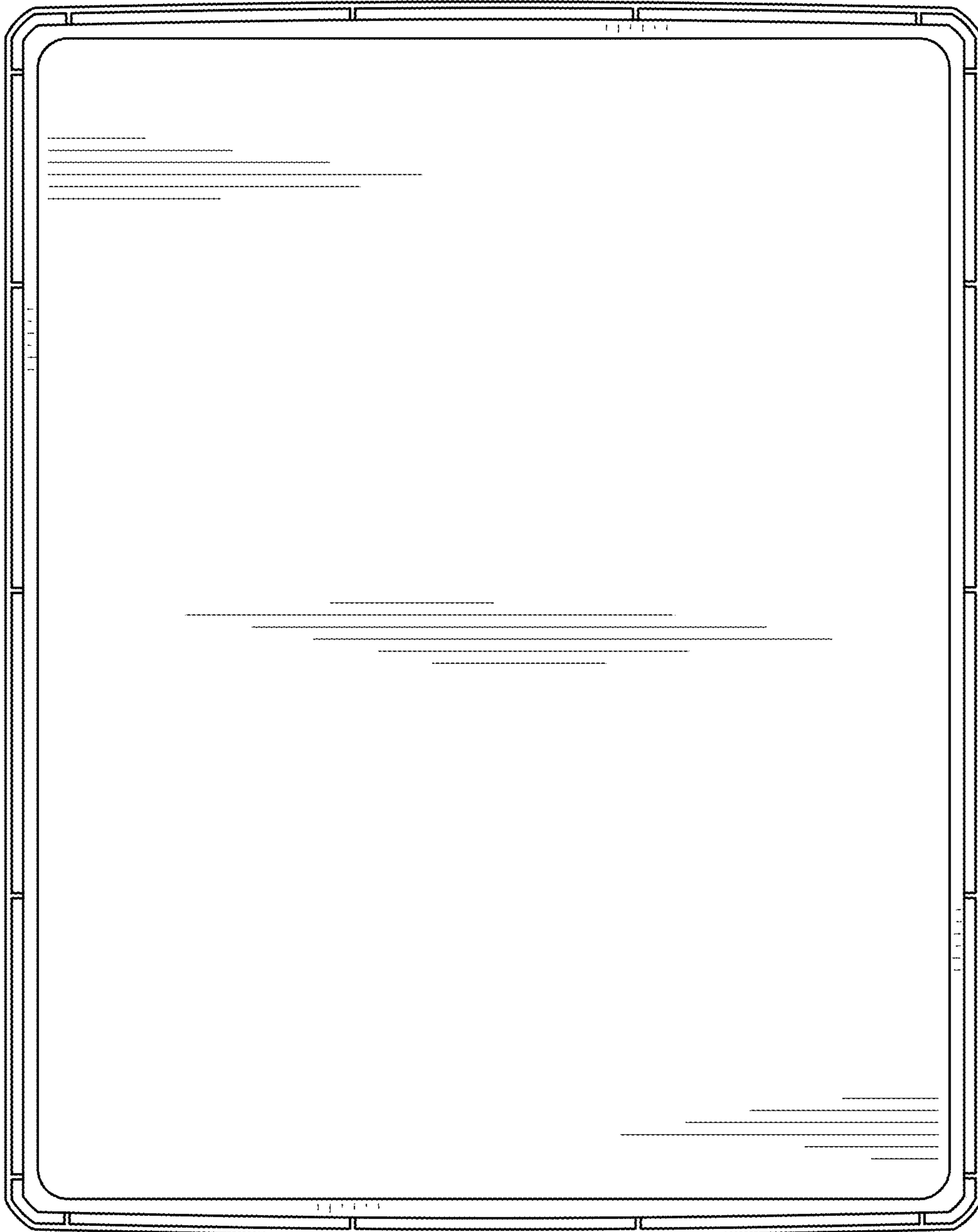

FIG. 10

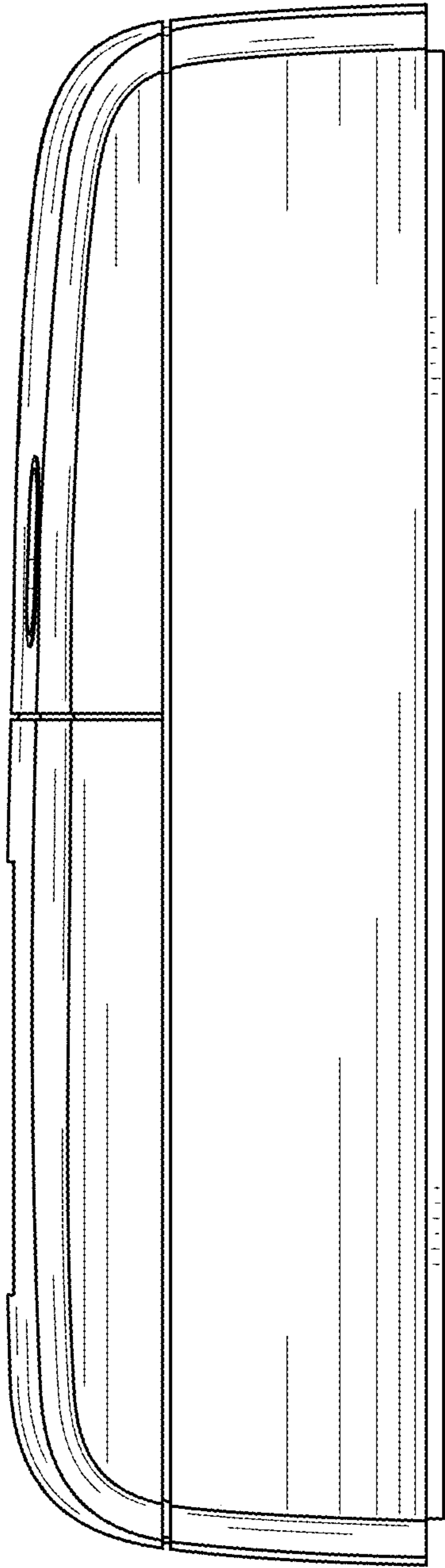

FIG. 11

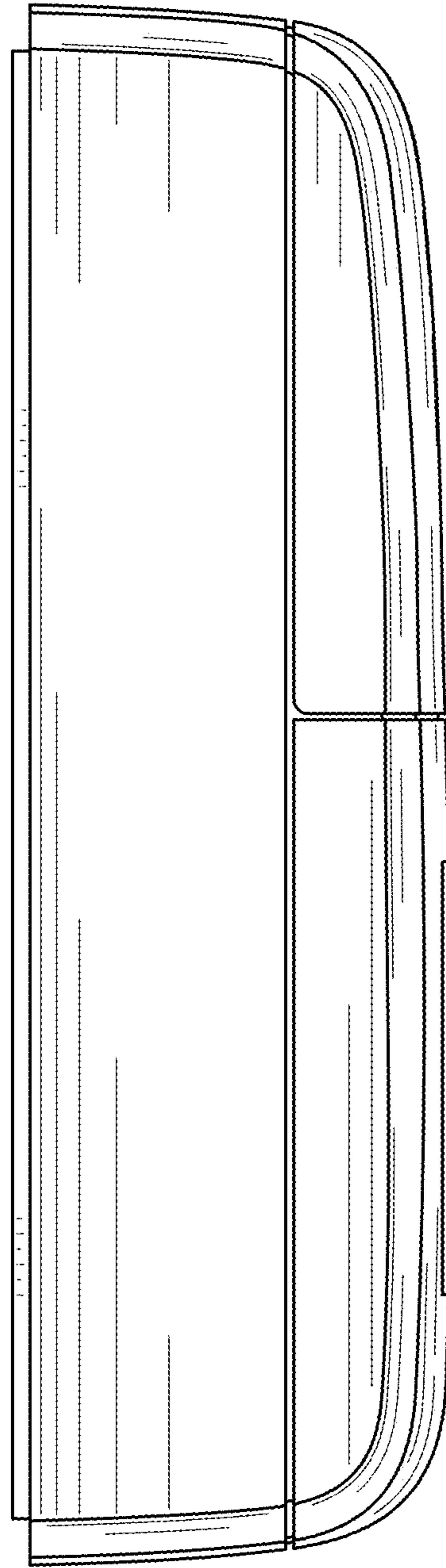

FIG. 12

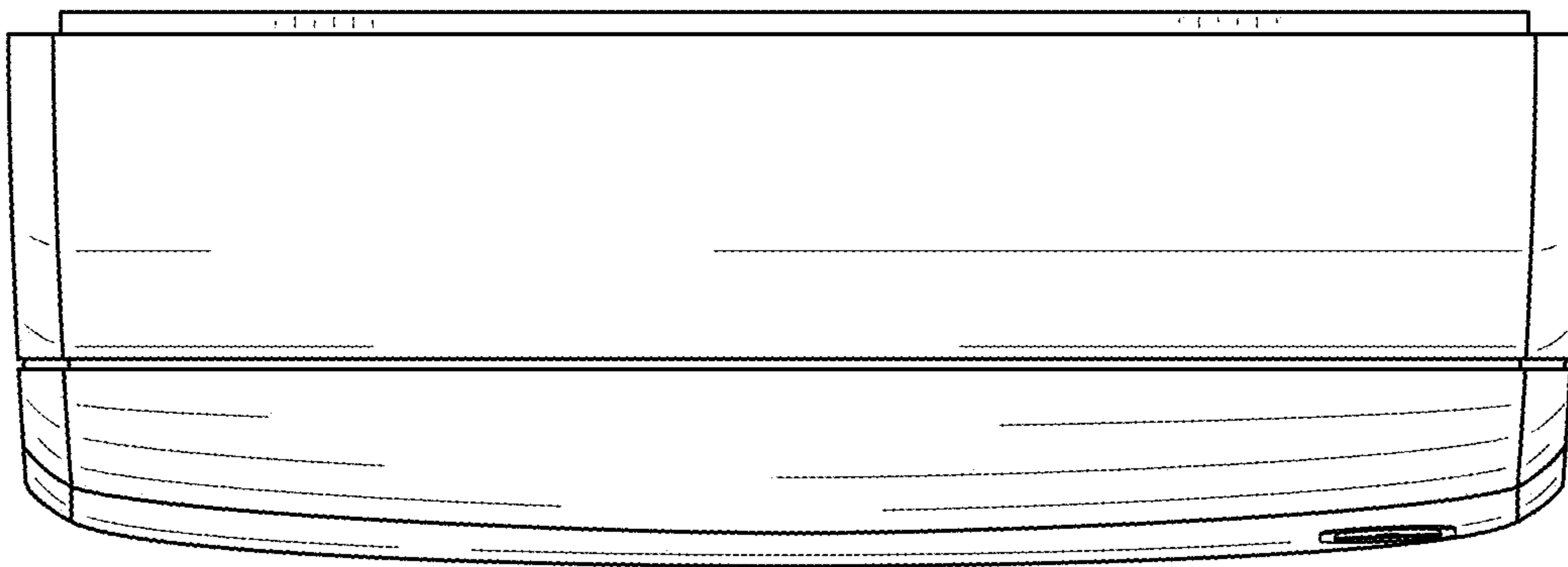

FIG. 13

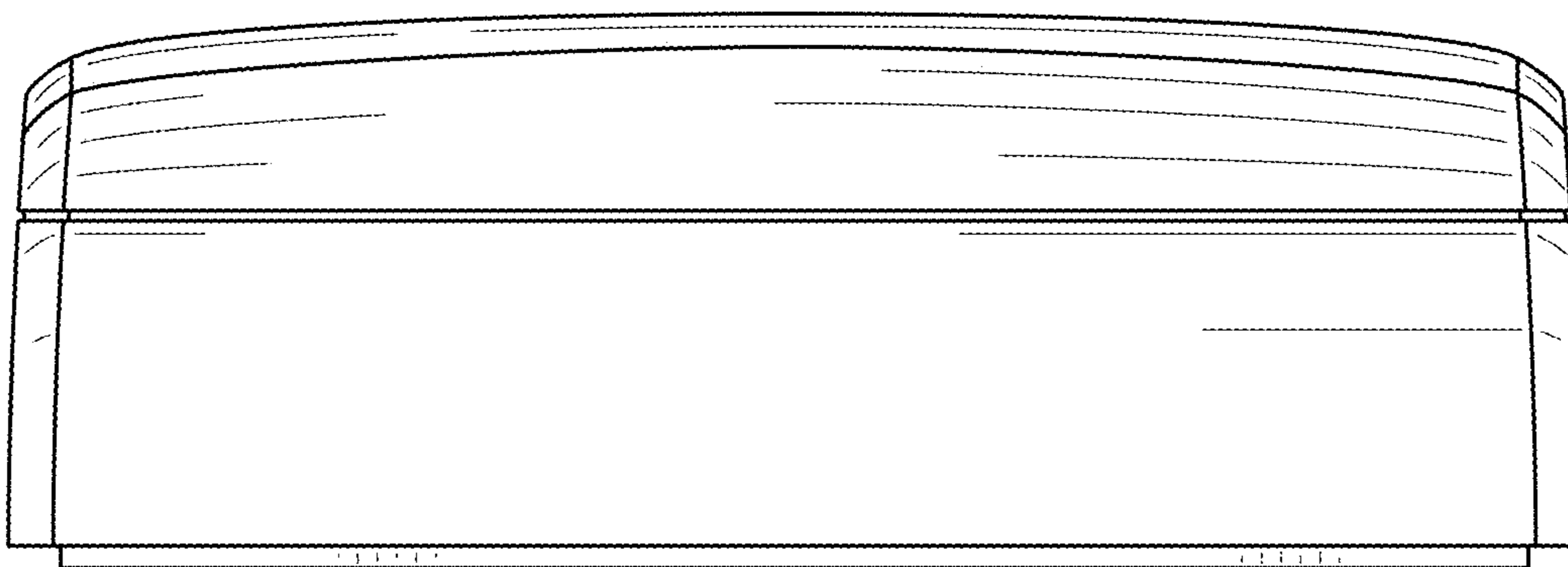

FIG. 14



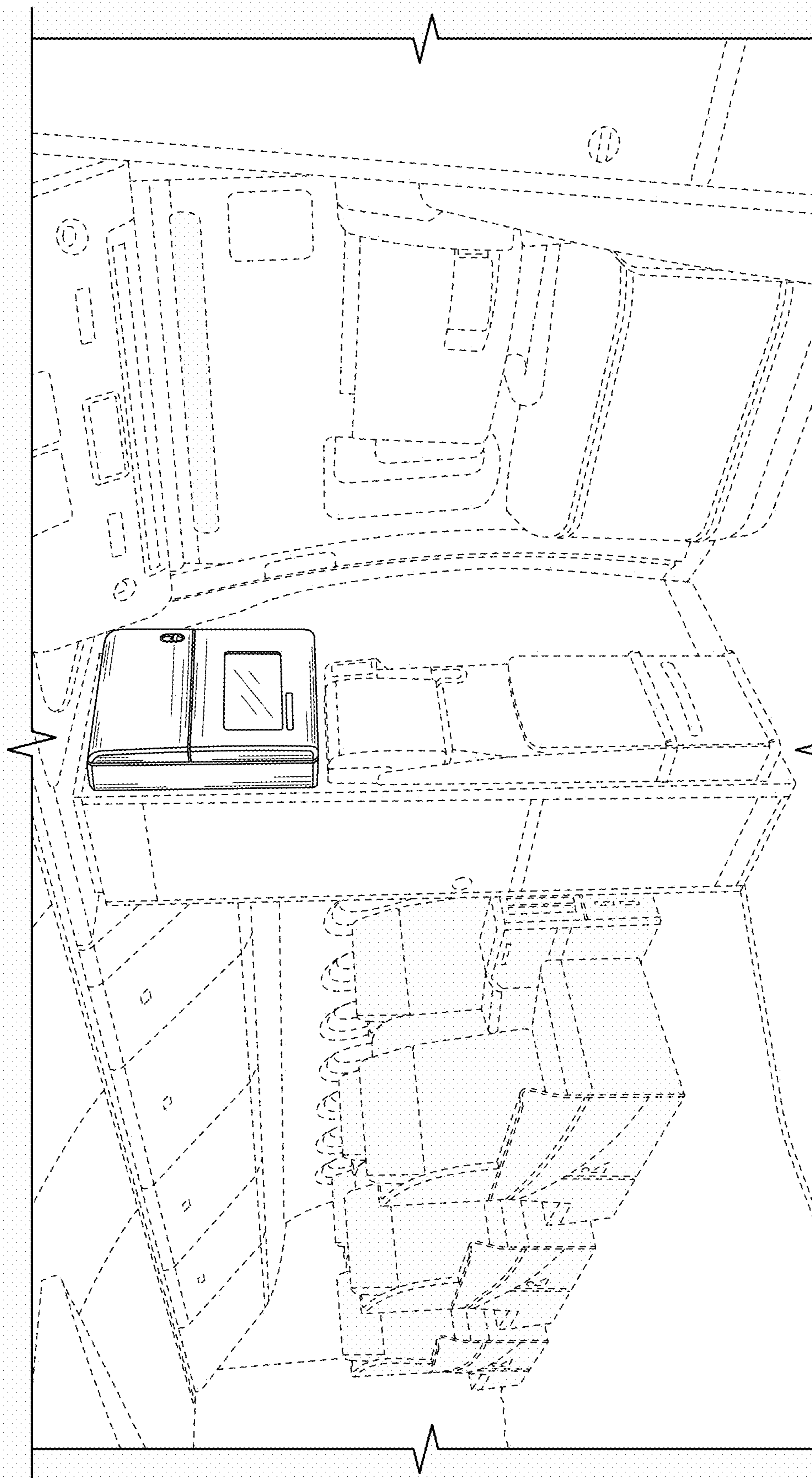

FIG. 15

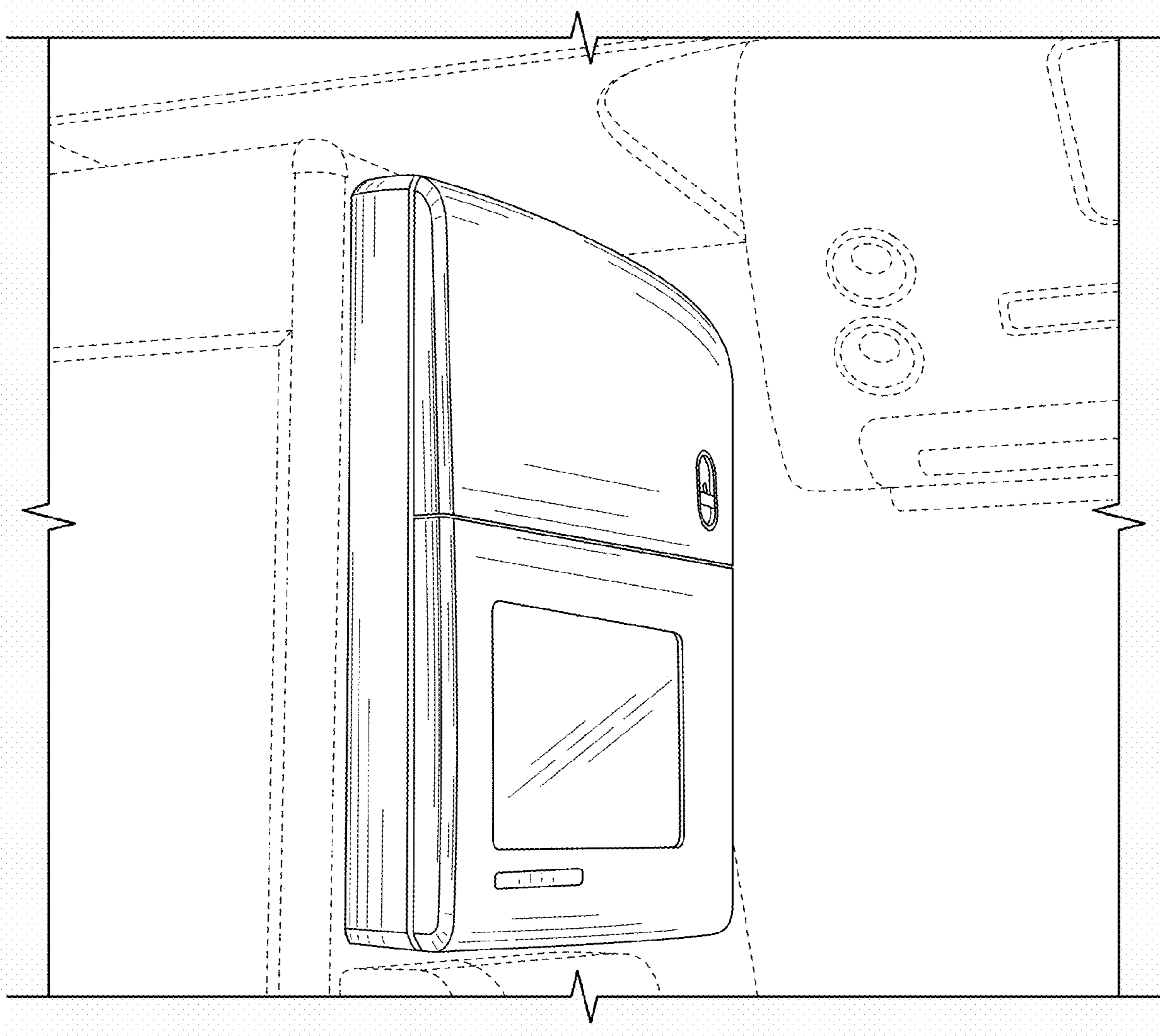

FIG. 16

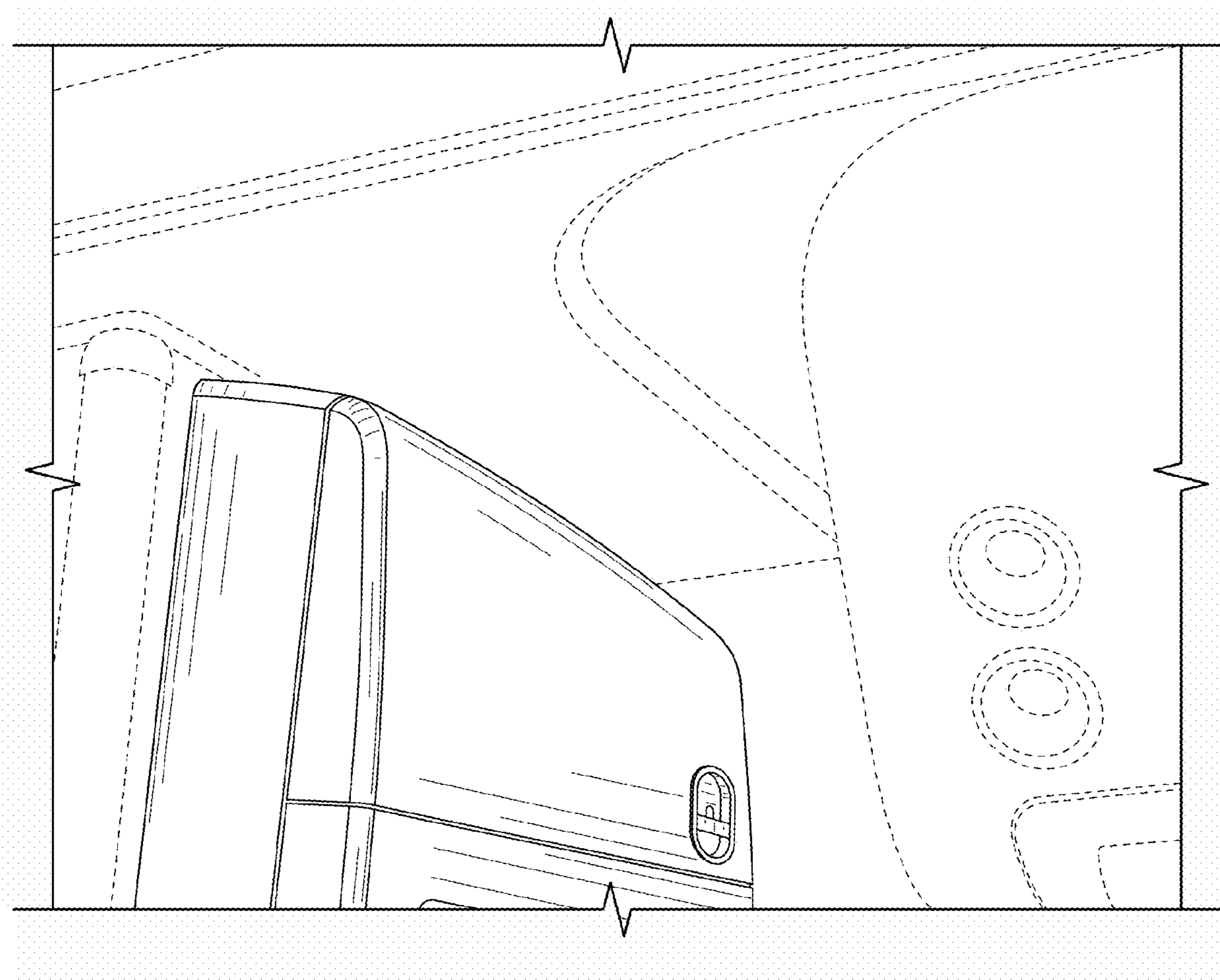

FIG. 17

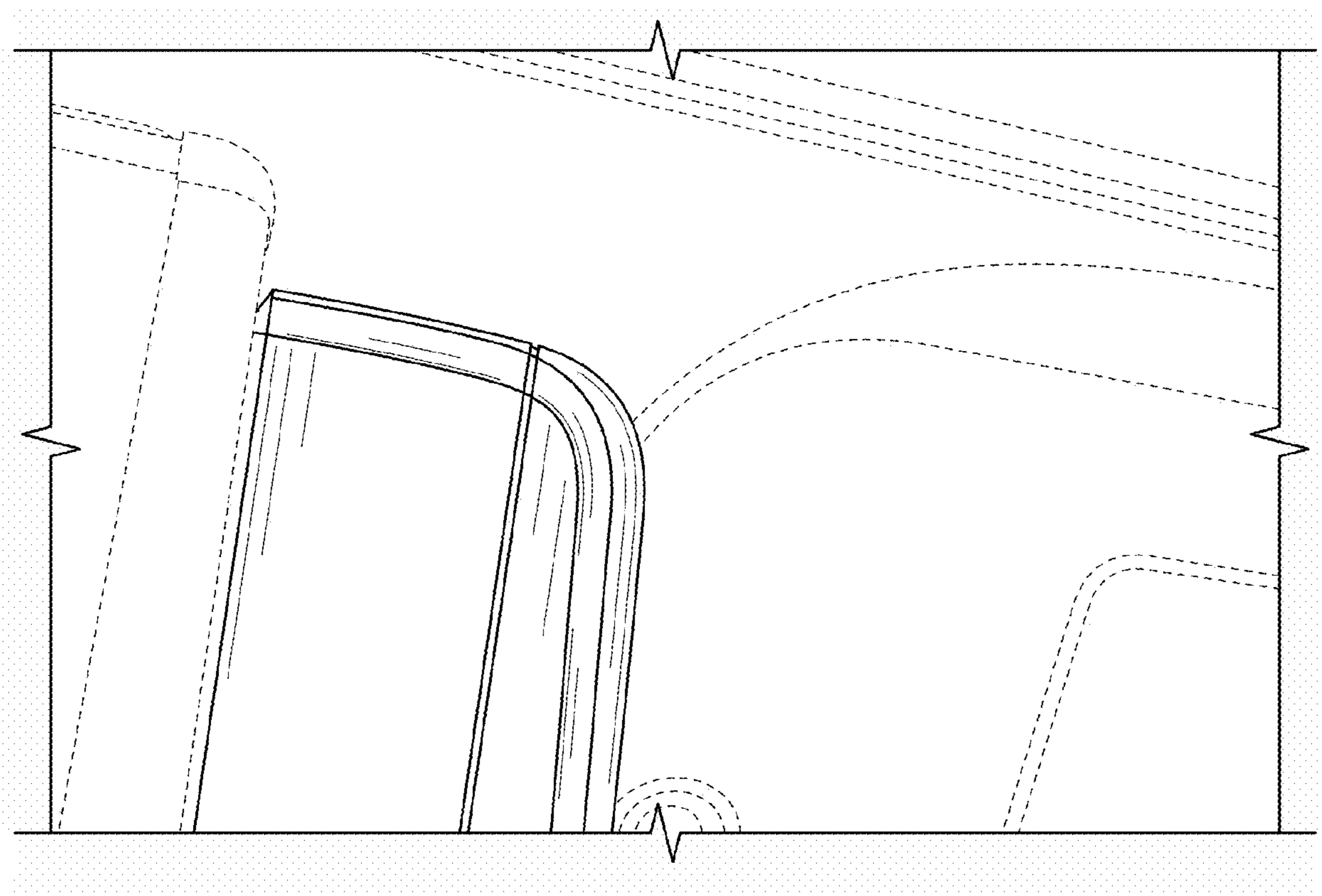

FIG. 18



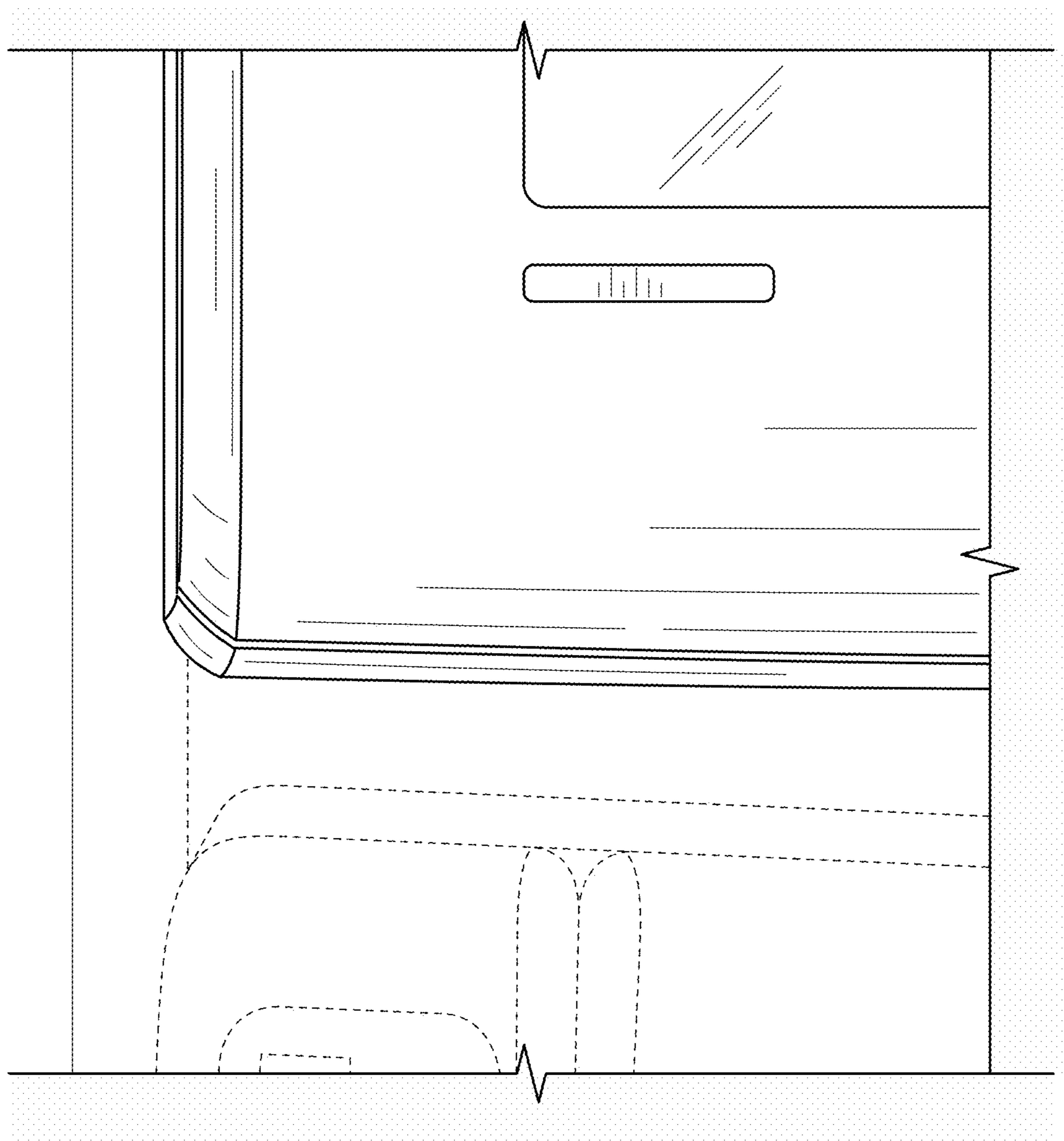

FIG. 19

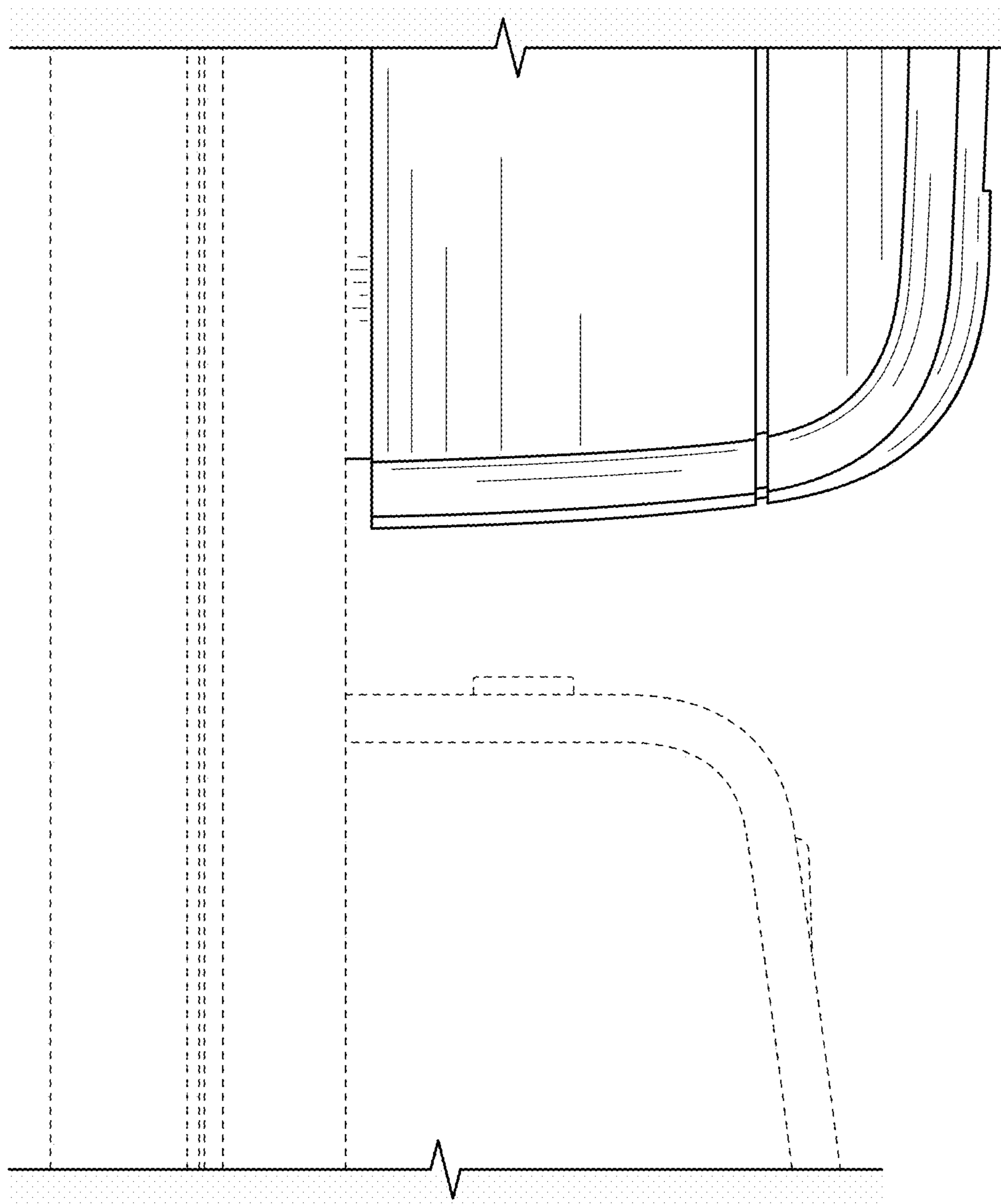

FIG. 20