



US00D890054S

(12) **United States Design Patent** (10) **Patent No.:** **US D890,054 S**
Platto et al. (45) **Date of Patent:** **** Jul. 14, 2020**

- (54) **VEHICLE TAILGATE**
- (71) Applicant: **Ford Global Technologies, LLC**,
Dearborn, MI (US)
- (72) Inventors: **Gordon Platto**, Troy, MI (US); **Sean Tant**, Livonia, MI (US); **Rick Howard**,
Brighton, MI (US)
- (73) Assignee: **Ford Global Technologies, LLC**,
Dearborn, MI (US)
- (**) Term: **15 Years**
- (21) Appl. No.: **29/678,067**
- (22) Filed: **Jan. 25, 2019**
- (51) **LOC (12) Cl.** **12-16**
- (52) **U.S. Cl.**
USPC **D12/196**
- (58) **Field of Classification Search**
USPC D12/90, 91, 92, 93, 96, 181, 184, 196
CPC .. B62D 25/02; B62D 25/04; B60J 5/00; B60J
5/02; B60J 5/04; B60J 5/10
See application file for complete search history.

- D750,002 S * 2/2016 Sato D12/196
- D758,271 S * 6/2016 McMahan D12/196
- D849,627 S * 5/2019 Zipfel D12/196
- D855,529 S * 8/2019 Dewitt D12/196
- D856,882 S * 8/2019 Ninov D12/196
- D859,253 S * 9/2019 Izard D12/196
- D859,254 S * 9/2019 Izard D12/196
- D865,605 S * 11/2019 Grewer D12/196

* cited by examiner

Primary Examiner — George D. Kirschbaum
Assistant Examiner — Joseph J Kukella

(74) *Attorney, Agent, or Firm* — Vichit Chea

(57) **CLAIM**

The ornamental design for a vehicle tailgate, as shown and described.

DESCRIPTION

FIG. 1 is a front elevational view of a vehicle tailgate, showing our new design;
 FIG. 2 is a left side elevational view thereof;
 FIG. 3 is a right side elevational view thereof;
 FIG. 4 is a top plan view thereof;
 FIG. 5 is a bottom plan view thereof;
 FIG. 6 is a top, front and left side perspective view thereof;
 and,
 FIG. 7 is a bottom, front and left side perspective view thereof.
 Any broken lines represent an internal boundary of the design; the line itself and the area within form no part of the claim.

1 Claim, 7 Drawing Sheets

- (56) **References Cited**
U.S. PATENT DOCUMENTS
D397,978 S * 9/1998 Helgeson D12/196
D556,110 S 11/2007 Schiavone et al.
D560,584 S * 1/2008 Tant D12/196
D710,283 S * 8/2014 O'Donnell D12/196
D710,777 S * 8/2014 Platto D12/196

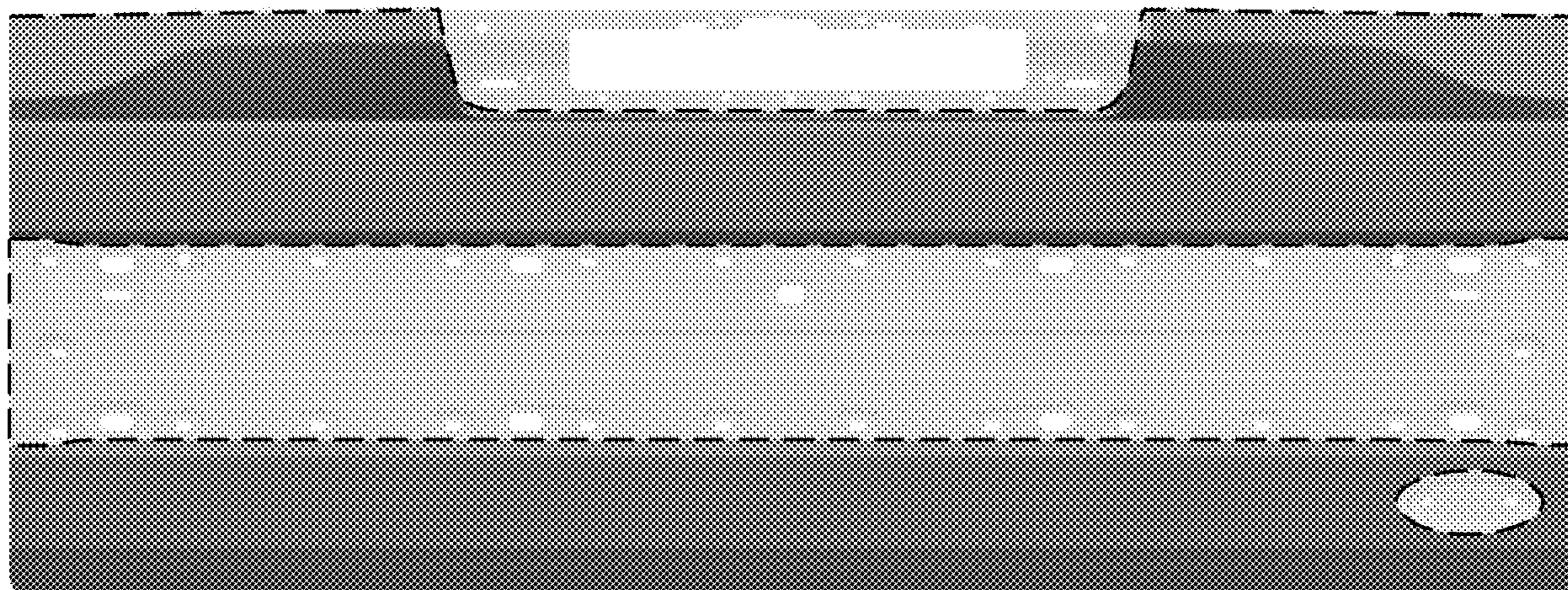

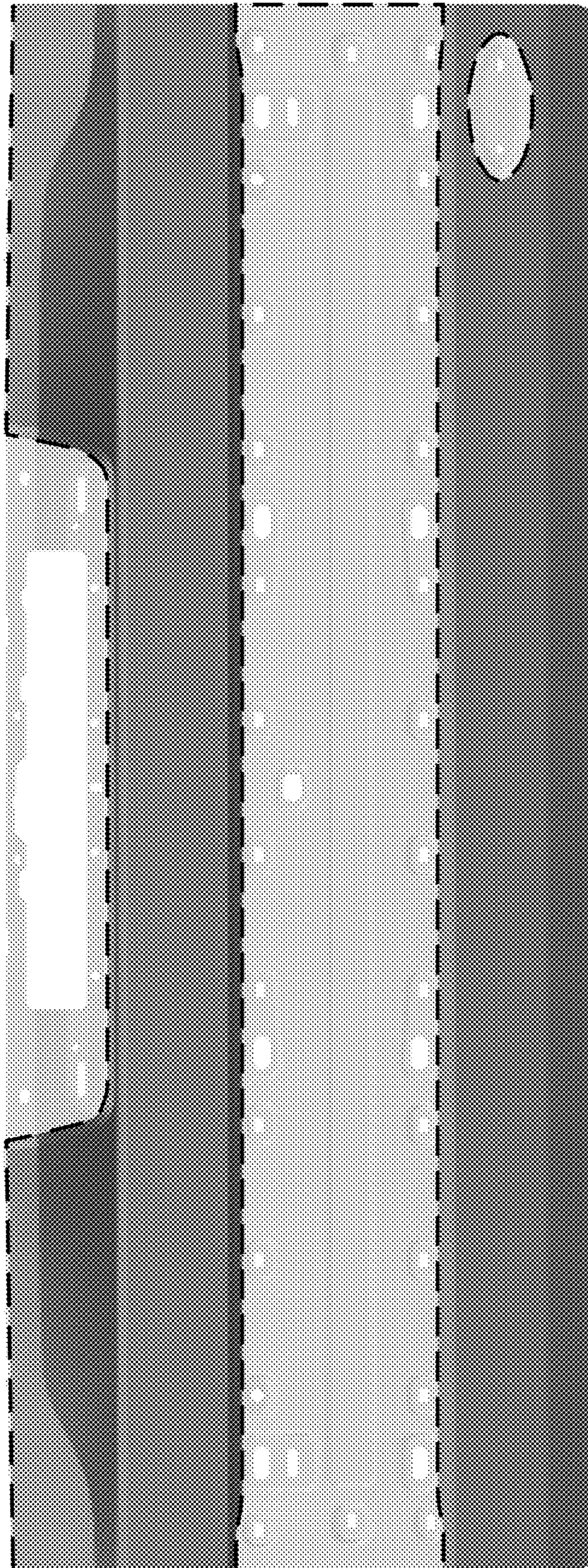

Fig. 1

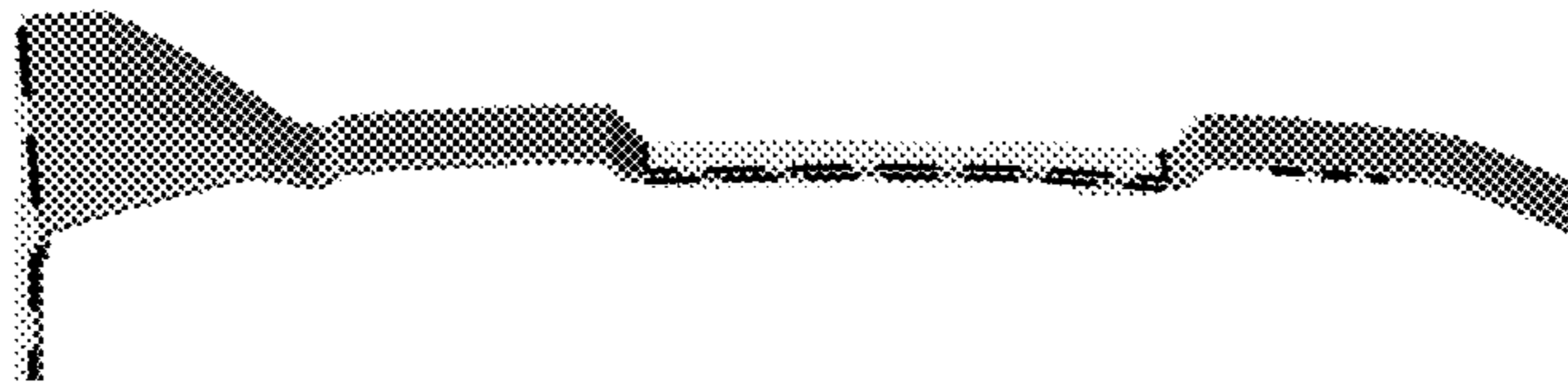

Fig. 2

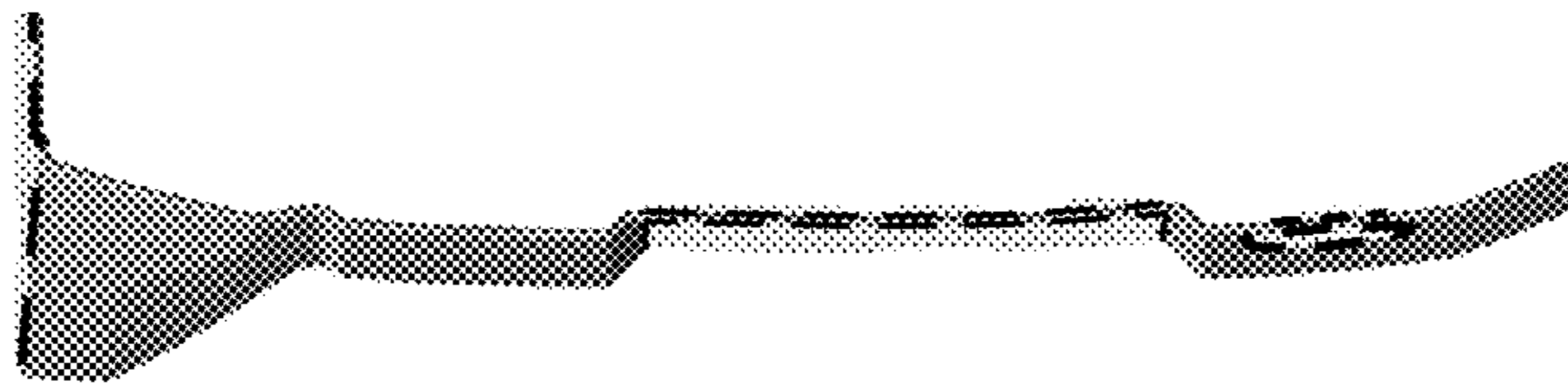

Fig. 3

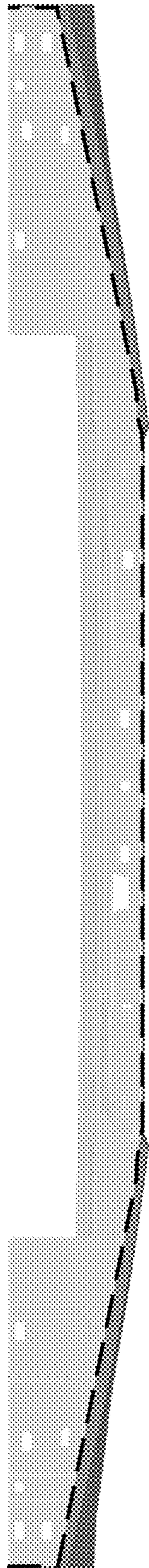
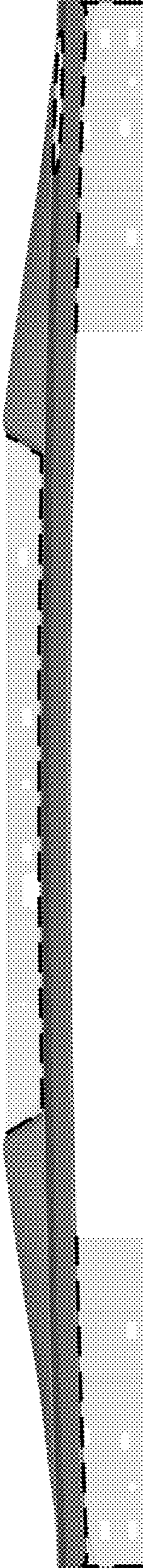

Fig. 4

Fig. 5



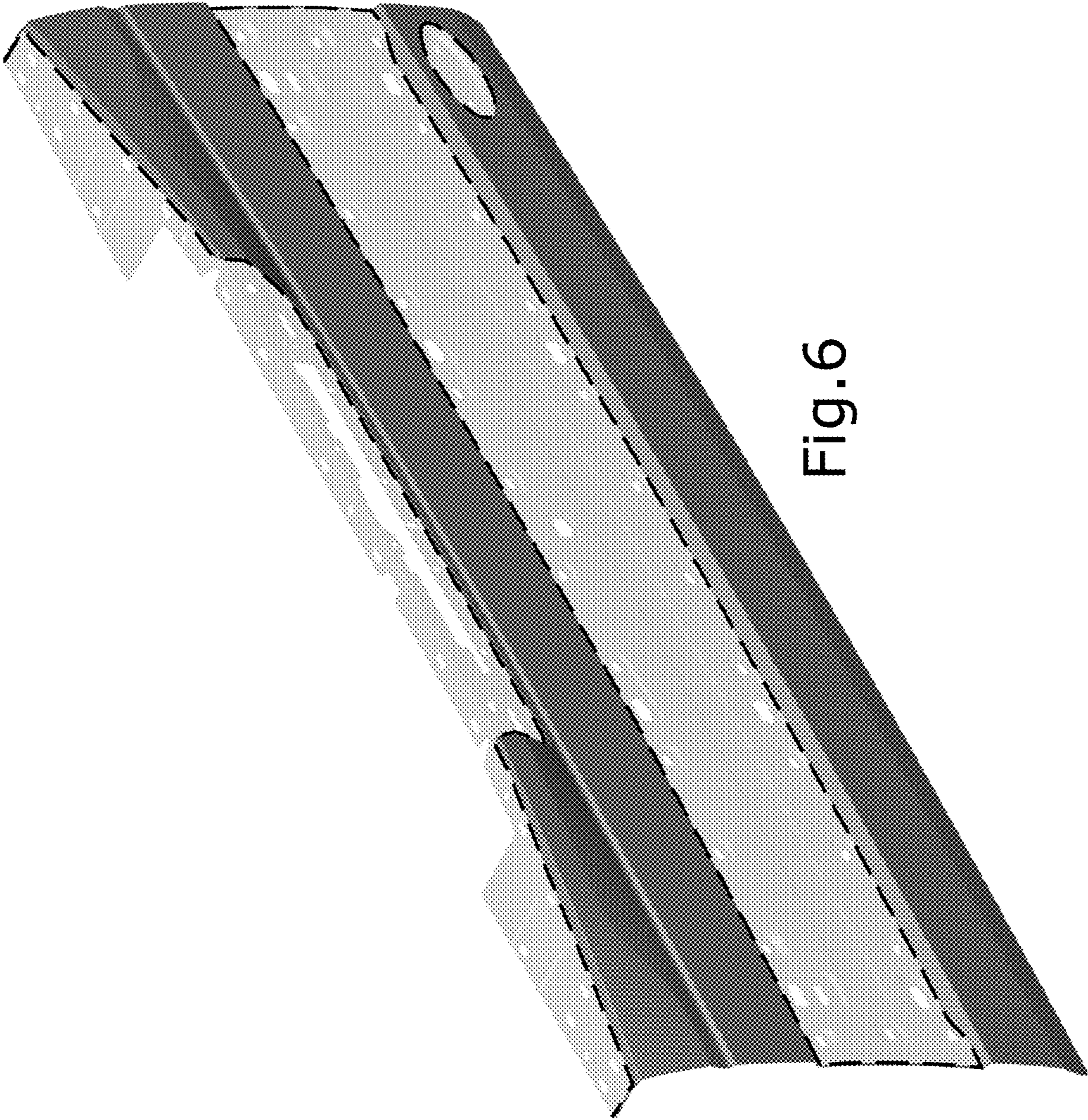

Fig. 6

Fig. 7

