



US00D889920S

(12) **United States Design Patent**
Feldman

(10) **Patent No.:** **US D889,920 S**
(45) **Date of Patent:** **** Jul. 14, 2020**

(54) **LEAF LIFTER DEVICE**

(71) Applicant: **Bruce Feldman**, West Hartford, CT
(US)

(72) Inventor: **Bruce Feldman**, West Hartford, CT
(US)

(**) Term: **15 Years**

(21) Appl. No.: **29/703,860**

(22) Filed: **Aug. 29, 2019**

(51) **LOC (12) Cl.** **08-01**

(52) **U.S. Cl.**
USPC **D8/10**

(58) **Field of Classification Search**
USPC D8/1, 10, 13

(Continued)

(56) **References Cited**

U.S. PATENT DOCUMENTS

2,751,245 A 6/1956 Boyd
3,643,410 A * 2/1972 Menning A01D 7/10
56/400.12

(Continued)

OTHER PUBLICATIONS

Leaf Grabber Long Handled, retrieved from <http://www.castlehardware.com/catalog/834/product/12630/leafgr> on Aug. 27, 2019, 2 pages.

(Continued)

Primary Examiner — Sheryl Lane

(74) *Attorney, Agent, or Firm* — Brian S. Steinberger;

Hilary E. Steinberger; Law Offices of Brian S. Steinberger, P.A.

(57) **CLAIM**

The ornamental design for a leaf lifter device, as shown and described.

DESCRIPTION

FIG. 1 is an upper front right perspective view of the novel leaf lifter device in an open position.

FIG. 2 is an upper rear right perspective view of the leaf lifter device of FIG. 1.

FIG. 3 is an upper front left perspective view of the leaf lifter device of FIG. 1.

FIG. 4 is an upper rear left perspective view of the leaf lifter device of FIG. 1.

FIG. 5 is a front view of the leaf lifter device of FIG. 1.

FIG. 6 is a rear view of the leaf lifter device of FIG. 1.

FIG. 7 is a left side view of the leaf lifter device of FIG. 1.

FIG. 8 is a right side view of the leaf lifter device of FIG. 1.

FIG. 9 is a top view of the leaf lifter device of FIG. 1.

FIG. 10 is a bottom view of the leaf lifter device of FIG. 1.

FIG. 11 is an upper right perspective view of the leaf lifter device of FIG. 1 in a closed position.

FIG. 12 is an upper rear right perspective view of the leaf lifter device of FIG. 11.

FIG. 13 is an upper front left perspective view of the leaf lifter device of FIG. 11.

FIG. 14 is an upper rear left perspective view of the leaf lifter device of FIG. 11.

FIG. 15 is a front view of the leaf lifter device of FIG. 11.

FIG. 16 is a rear view of the leaf lifter device of FIG. 11.

FIG. 17 is a left side view of the leaf lifter device of FIG. 11.

FIG. 18 is a right side view of the leaf lifter device of FIG. 11.

FIG. 19 is a top view of the leaf lifter device of FIG. 11; and, FIG. 20 is a bottom view of the leaf lifter device of FIG. 11.

1 Claim, 20 Drawing Sheets

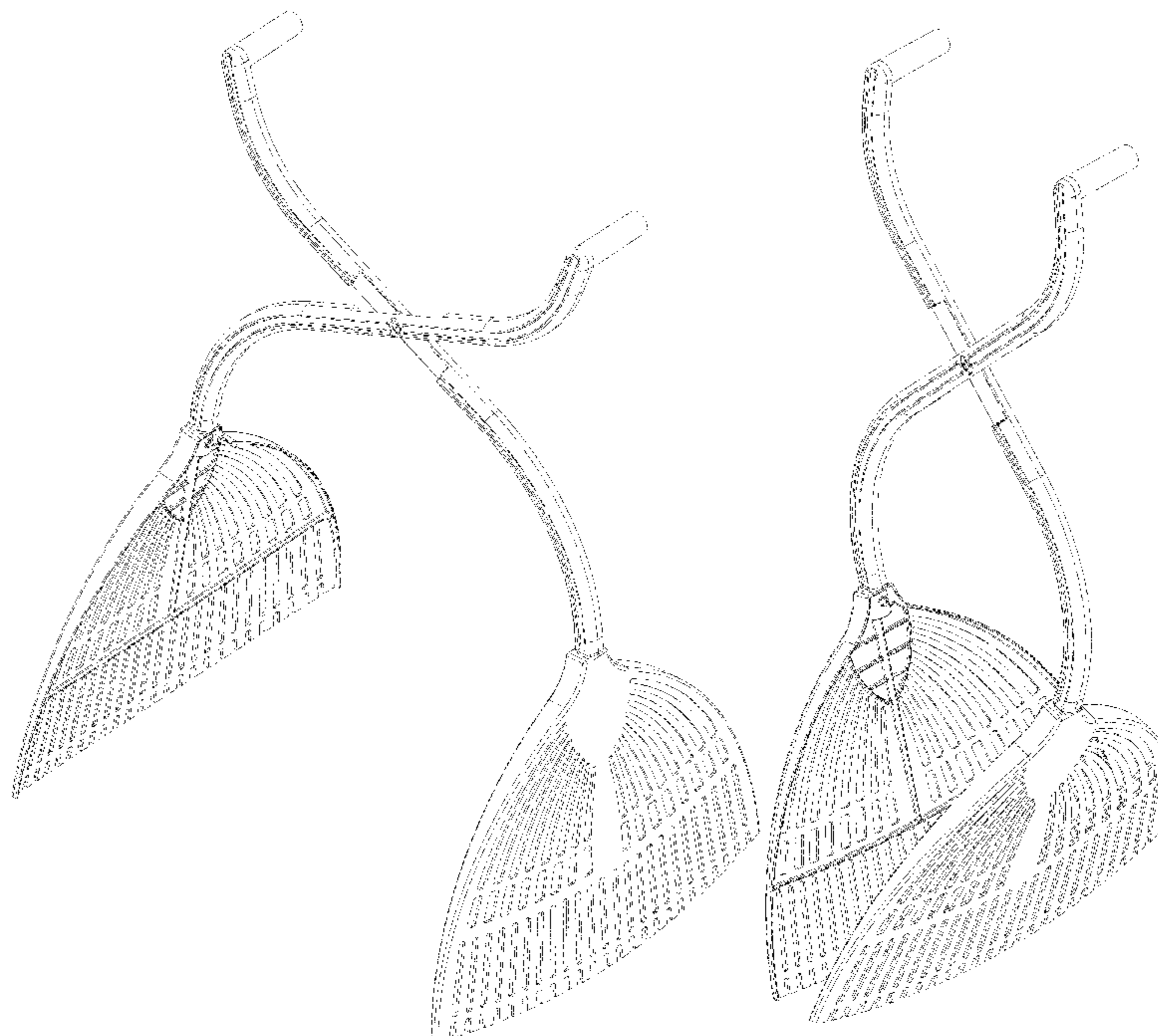

(58) **Field of Classification Search**
 CPC A01B 1/00; A01D 7/00; A01D 7/10
 See application file for complete search history.

(56) **References Cited**

U.S. PATENT DOCUMENTS

3,688,484 A 9/1972 Cox
 4,037,397 A * 7/1977 Fiorentino A01D 7/10
 56/400.12
 D263,367 S * 3/1982 Fodor D8/13
 4,744,208 A * 5/1988 King A01D 7/00
 56/400.16
 D296,510 S * 7/1988 Cohen D8/1
 4,791,780 A * 12/1988 Phillips A01D 7/00
 294/52
 4,991,386 A * 2/1991 Dirksen A01D 7/00
 294/50.8
 5,114,199 A * 5/1992 Newcomer A01B 1/00
 294/118
 D336,731 S * 6/1993 Nichols, Jr. D8/382
 D368,631 S * 4/1996 Swierczynski D8/107
 5,564,266 A 10/1996 Laughlin
 5,564,267 A * 10/1996 Bricker A01D 7/10
 294/50.8
 D384,865 S * 10/1997 Baran 294/50.8
 D391,132 S * 2/1998 Gandee D8/13
 D391,814 S * 3/1998 Lindsey D8/13
 5,901,540 A * 5/1999 Vella A01D 7/10
 294/50.6
 D465,705 S * 11/2002 Hinden D8/13

D505,304 S * 5/2005 Conaway D8/13
 D506,112 S 6/2005 Roberson et al.
 D509,415 S * 9/2005 Crites D8/13
 7,168,230 B1 1/2007 Waddell
 D577,967 S * 10/2008 Norton D8/13
 D582,737 S * 12/2008 Mullen D8/10
 7,661,258 B1 * 2/2010 Petruzelli A01D 7/10
 56/400.12
 D625,161 S * 10/2010 Rosaen D8/13
 D625,571 S * 10/2010 Frenkel D8/13
 D634,593 S * 3/2011 Kavanagh D8/4
 D701,097 S 3/2014 Petruzzelli et al.
 D766,682 S 9/2016 Flournoy
 2006/0185862 A1 * 8/2006 McIntosh A01B 1/00
 172/371

OTHER PUBLICATIONS

3-in-1 Yellow Ergonomic Lightweight 17-Inch Lawn Leaf Grabber
 Claw Garden Pickup, retrieved from <https://www.ebay.com/itm/3-In-1-Yellow-Ergonomic-Lightweight> on Aug. 27, 2019, 4 pages.
 Spear & Jackson, Leaf Grabber retrieved from <http://www.spearandjack.com.au/products/SJ-LG-1> on Aug. 28, 2019, 1 page.
 Gardman, Leaf grabber, retrieved from <https://www.gardman.co.uk/leaf-grabber.html> on Aug. 28, 2019, 2 pages.
 UPP Long Handled Leaf Grabber, retrieved from <https://www.upp-shop.de/en/upp-long-handled-leaf-grabber.html> on Aug. 27, 2019, 6 pages.
 Garden Grab X—The Ultimate Leaf and Garden Grabber, retrieved from <http://gradengrabx.com> on Aug. 27, 2019, 2 pages.

* cited by examiner

FIG. 1

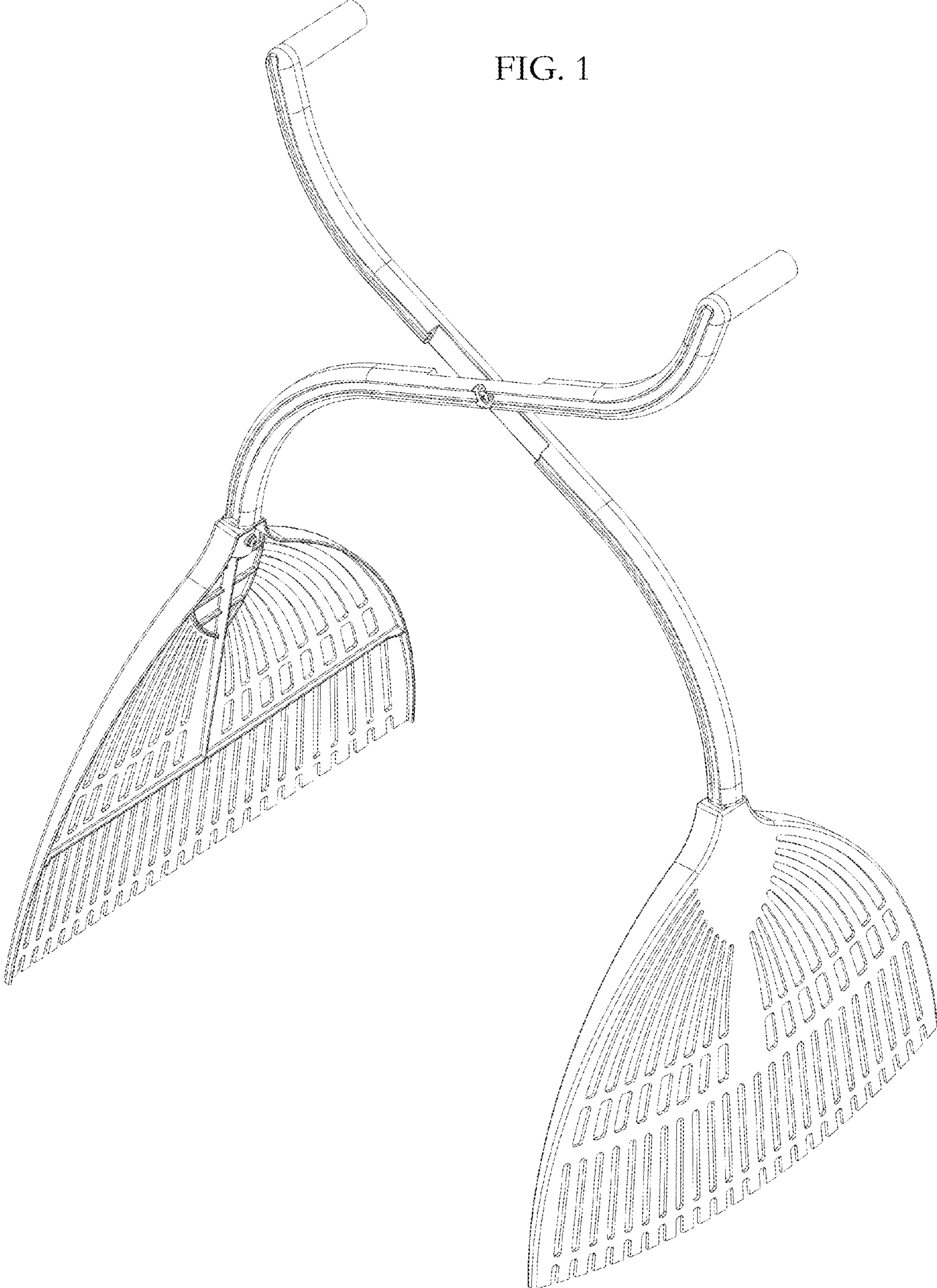

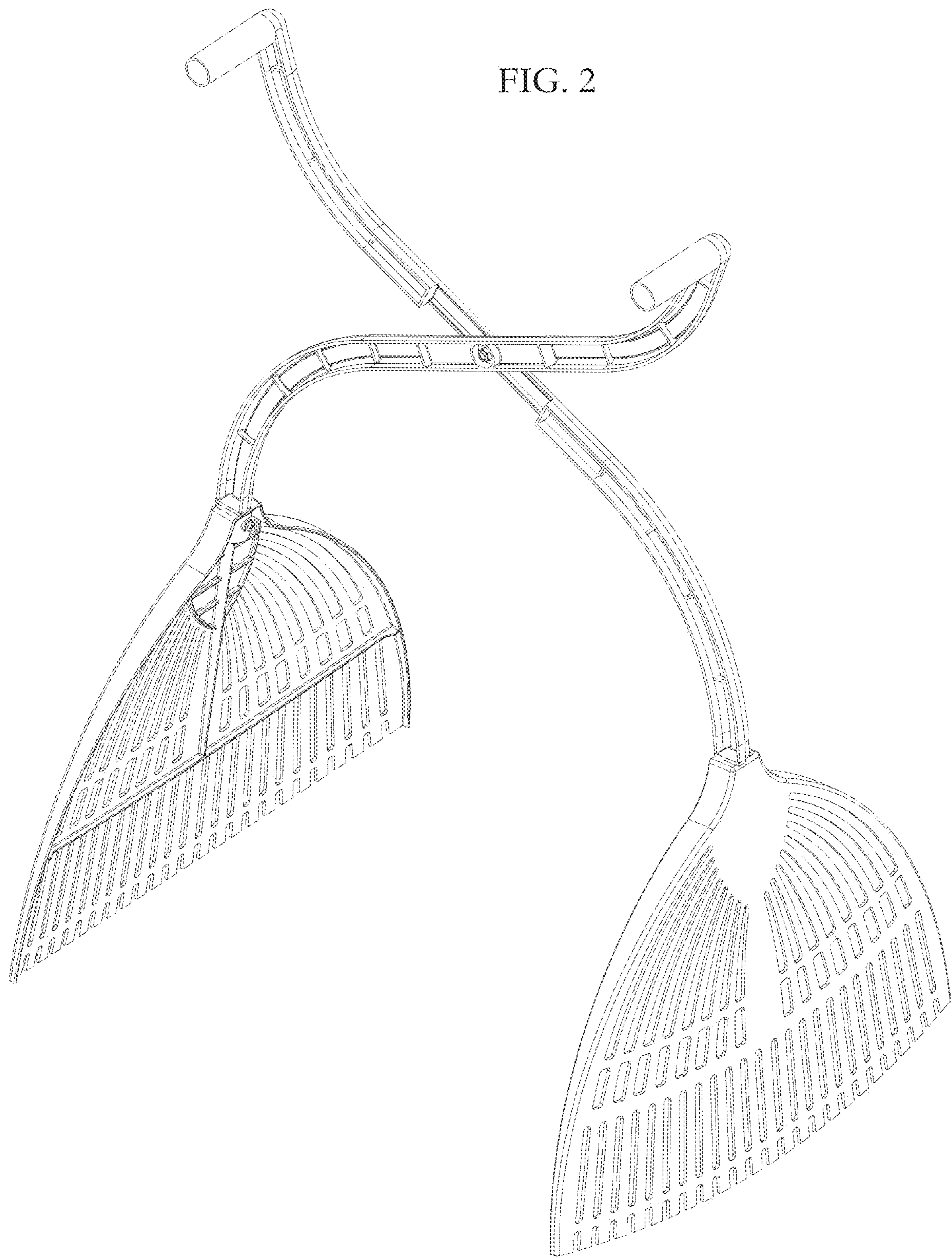

FIG. 3

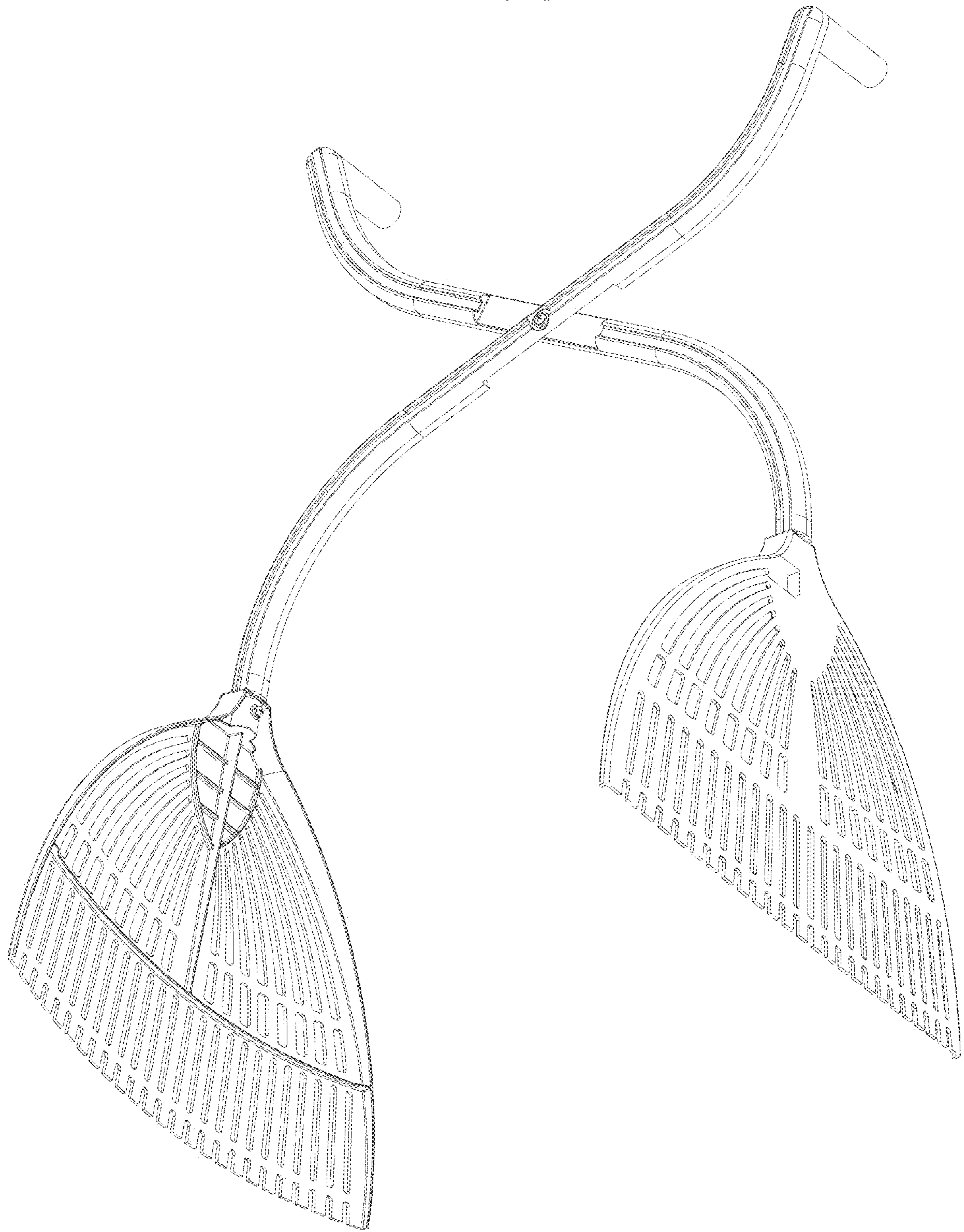

FIG. 4

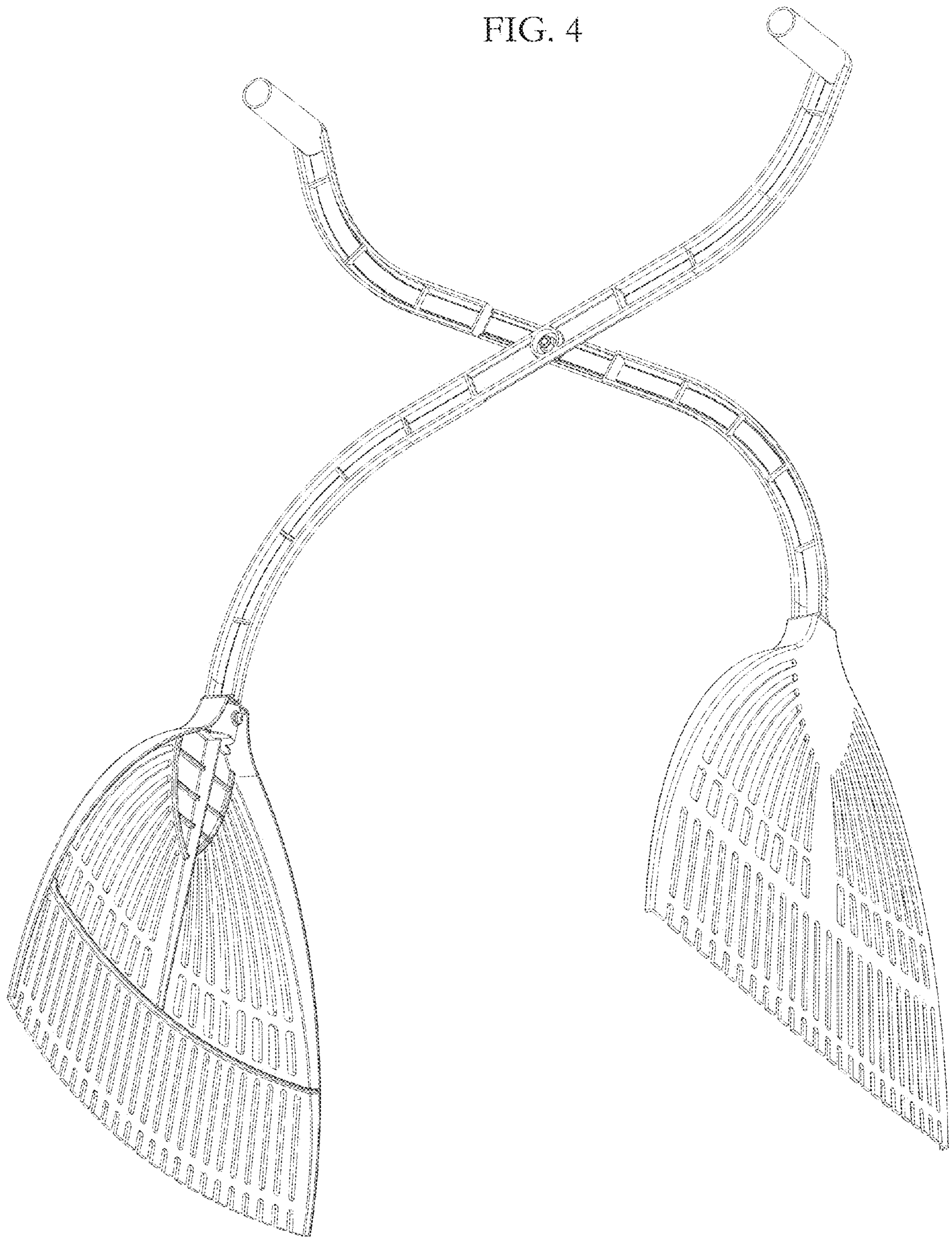

FIG. 5

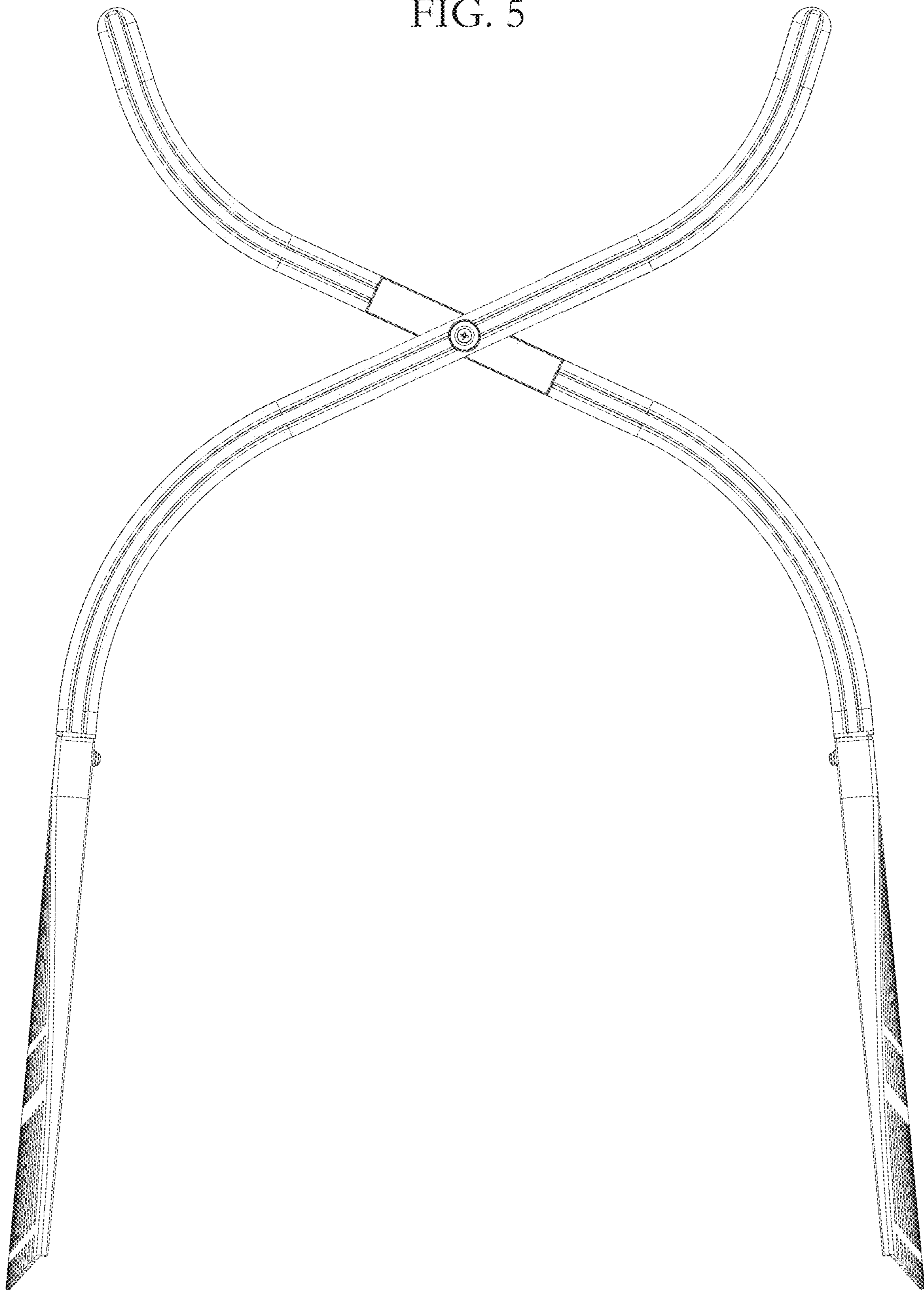

FIG. 6

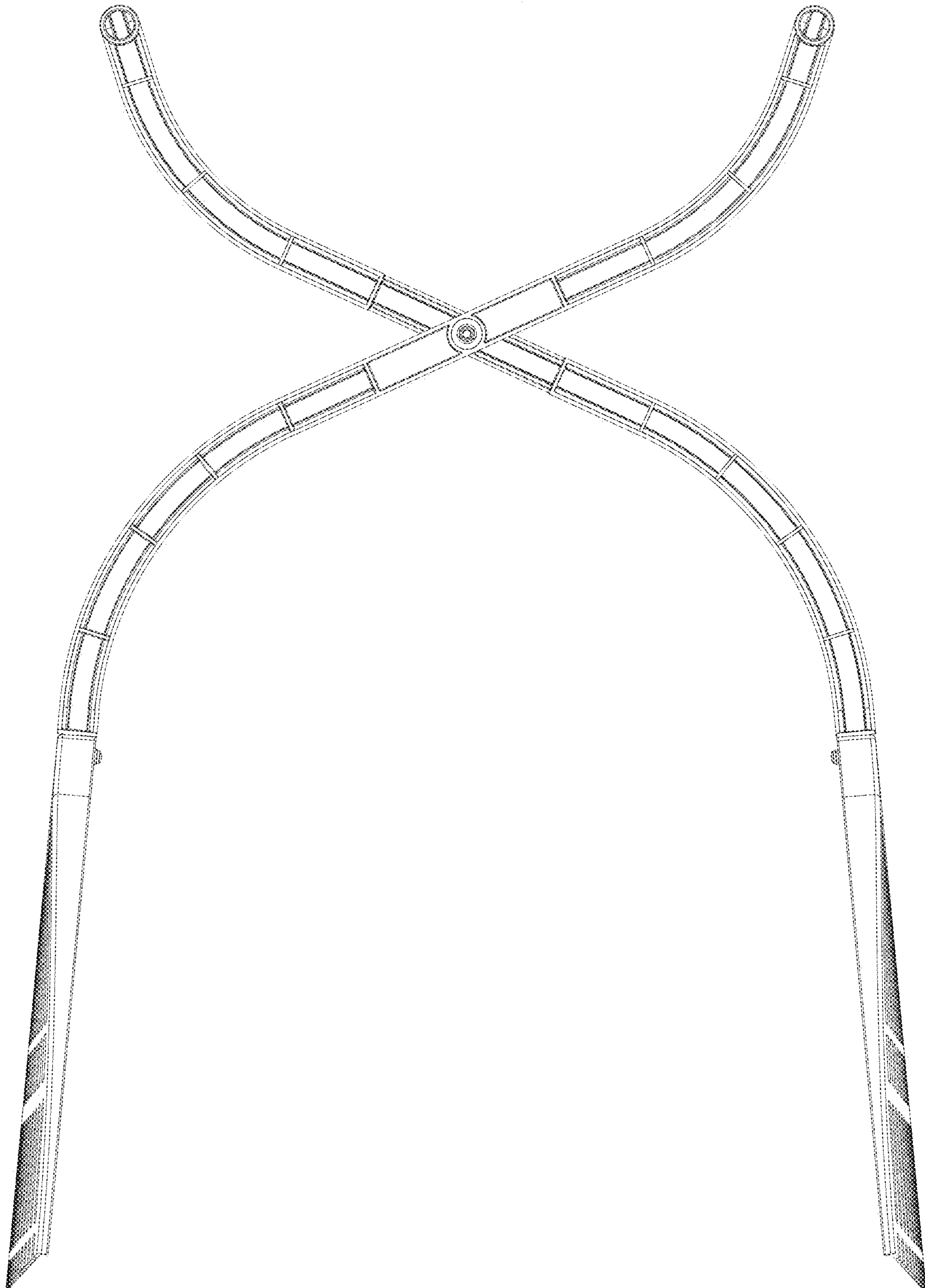

FIG. 7

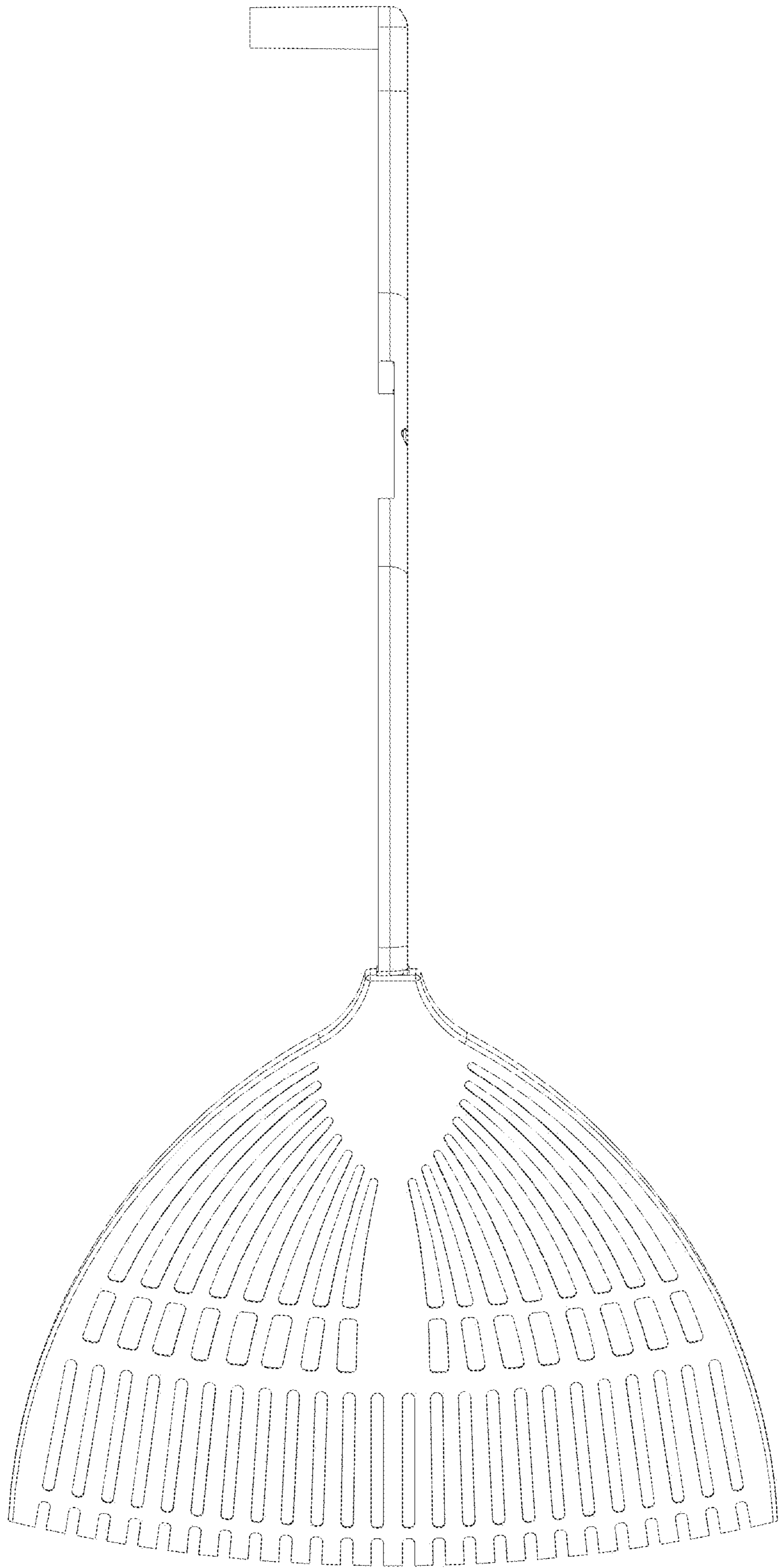

FIG. 8

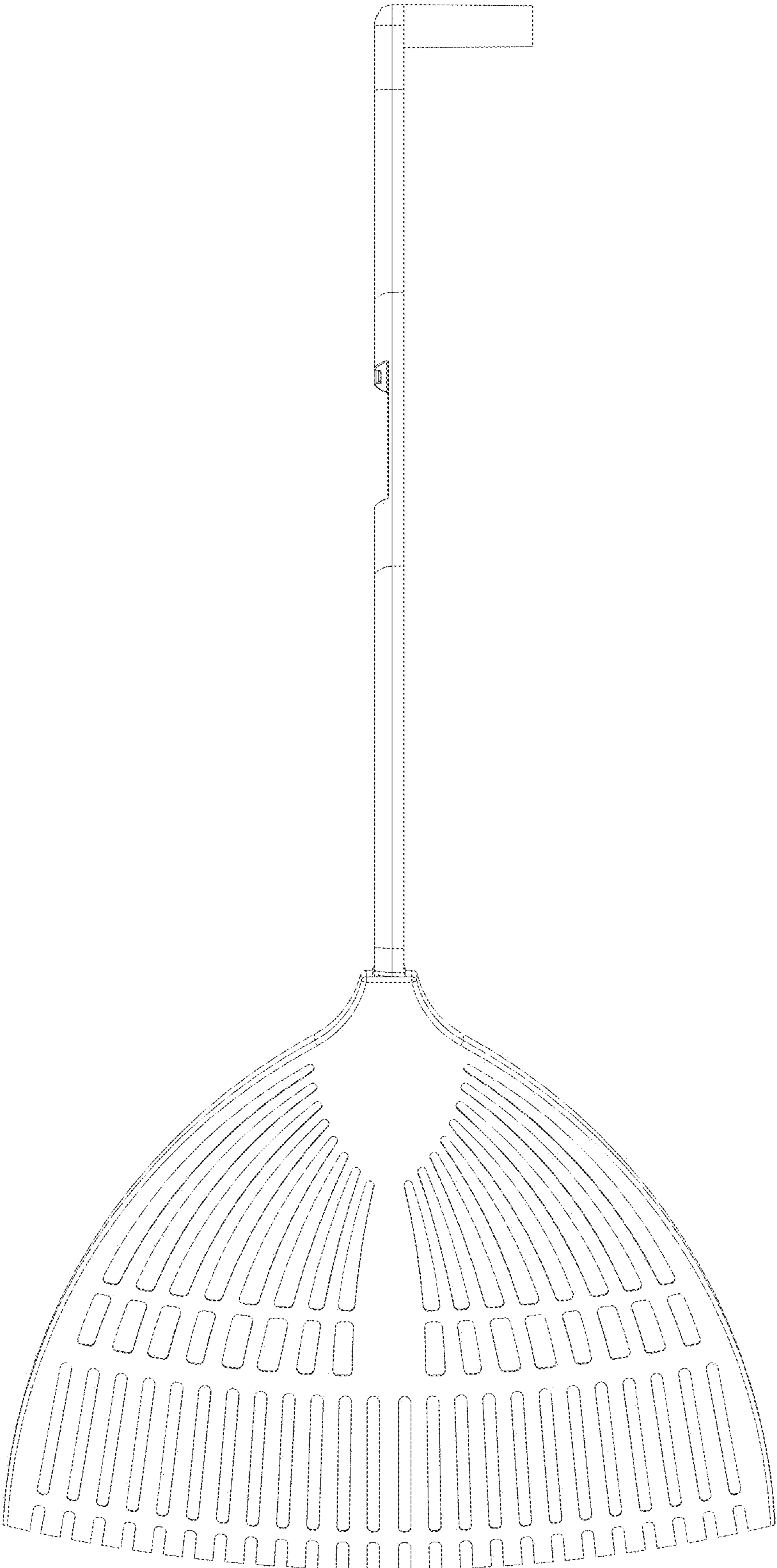

FIG. 9

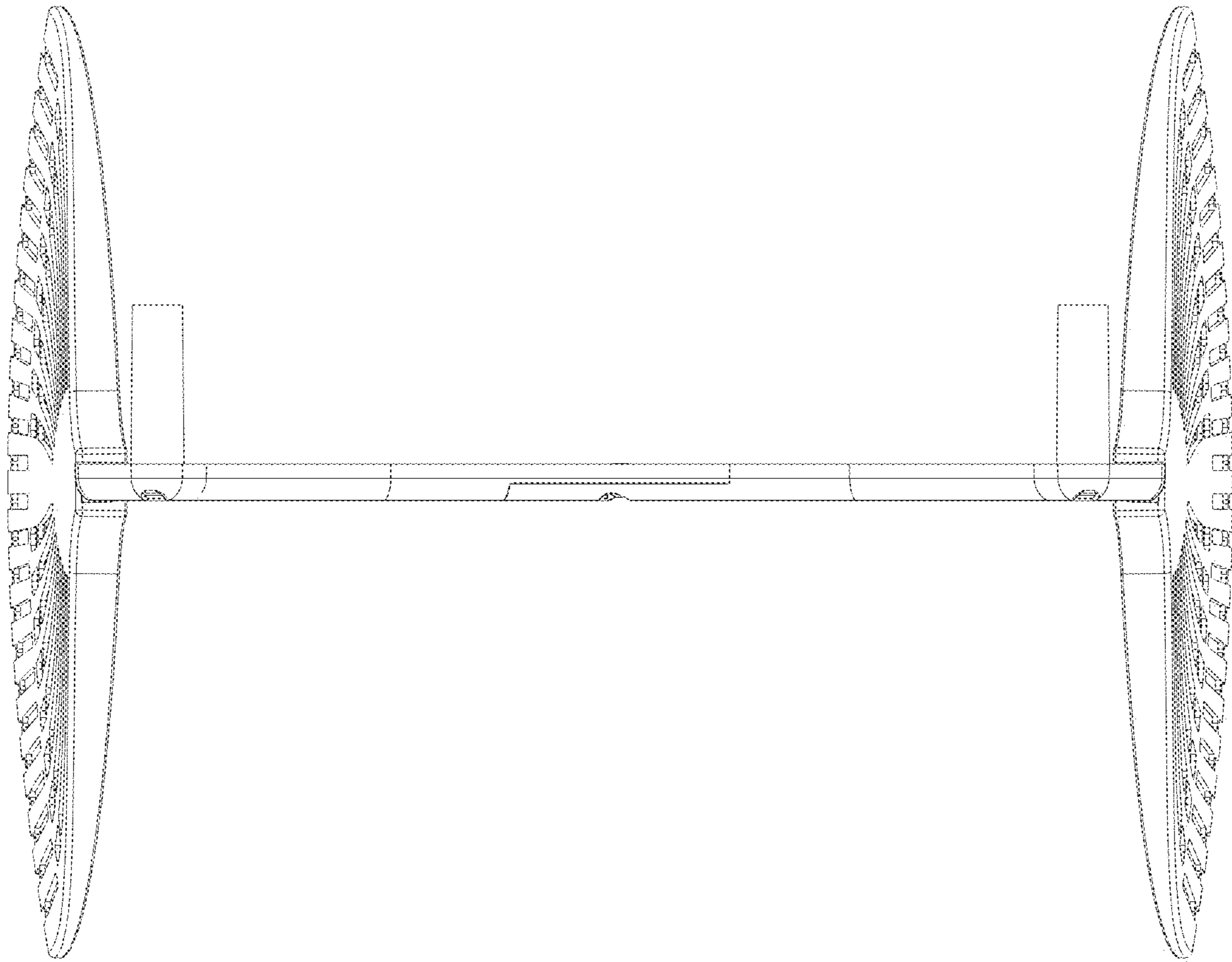

FIG. 10

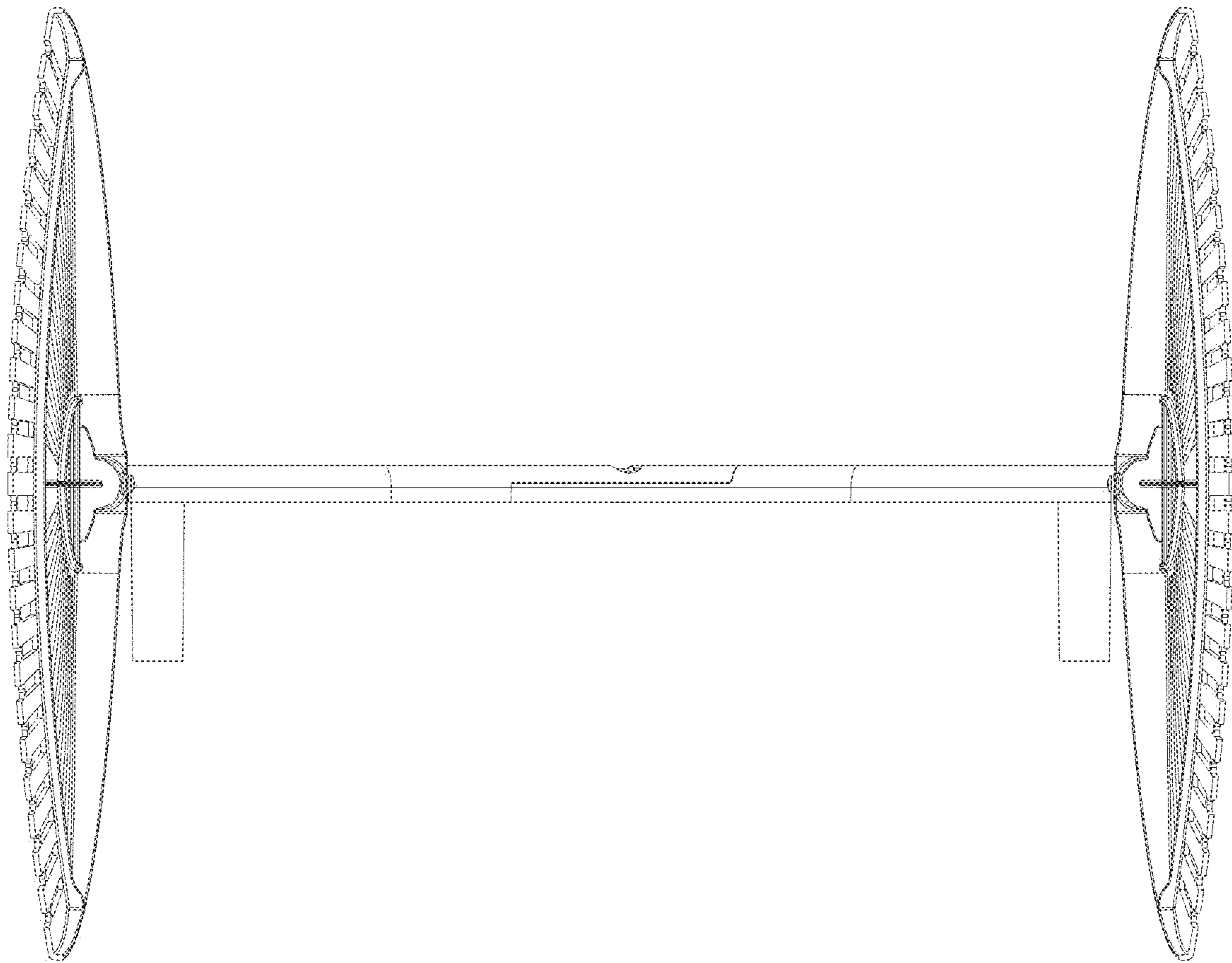

FIG. 11

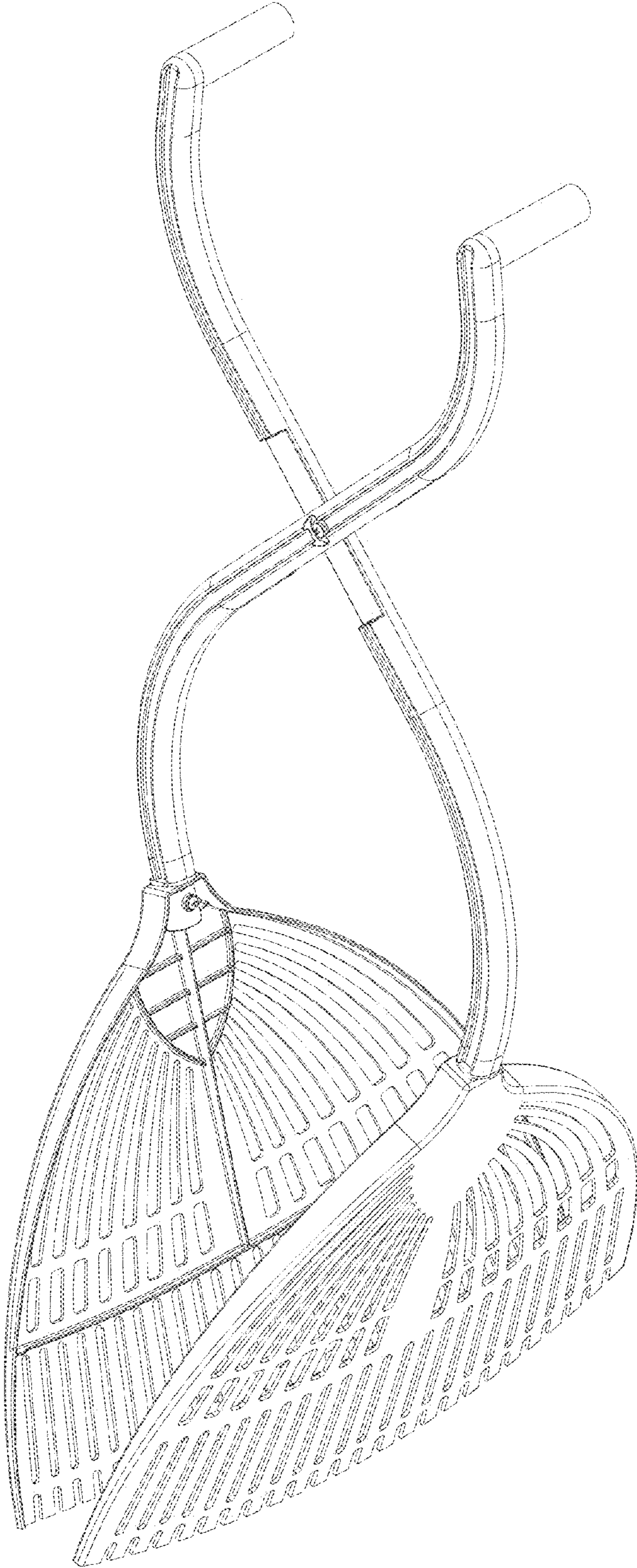

FIG. 12

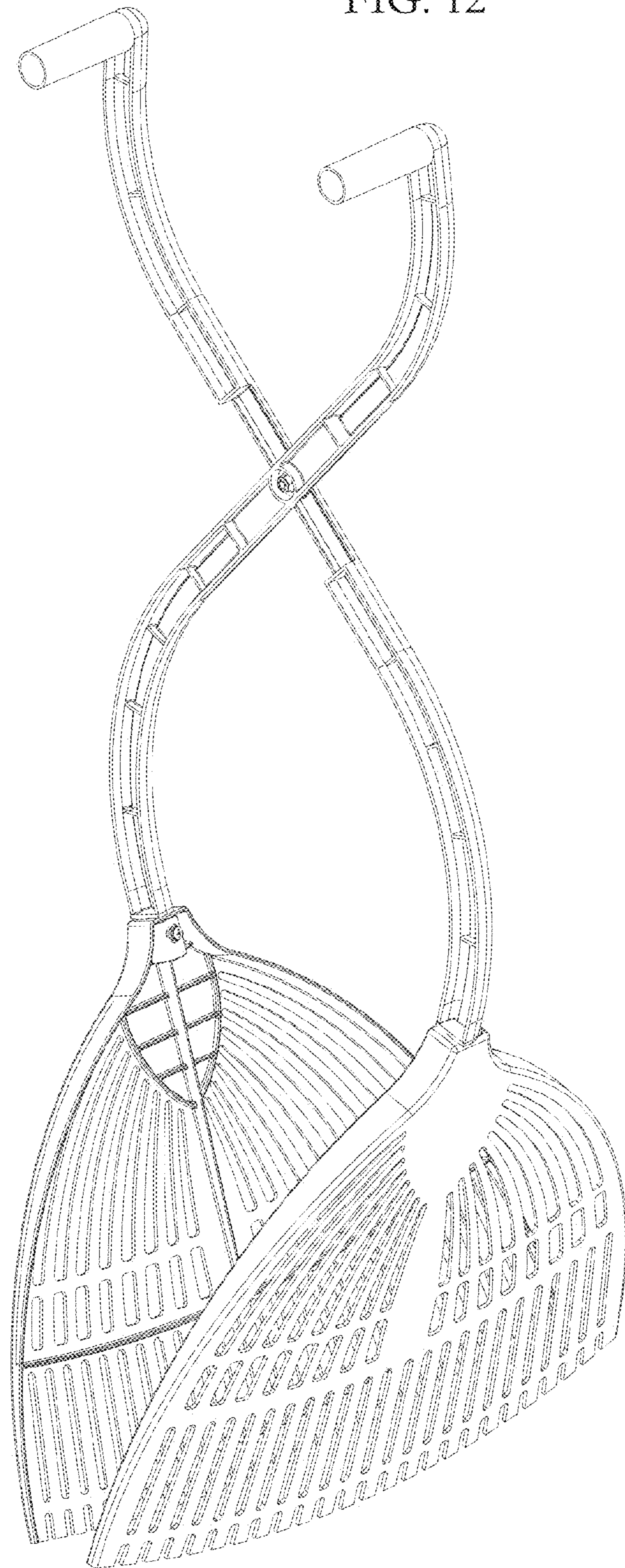

FIG. 13

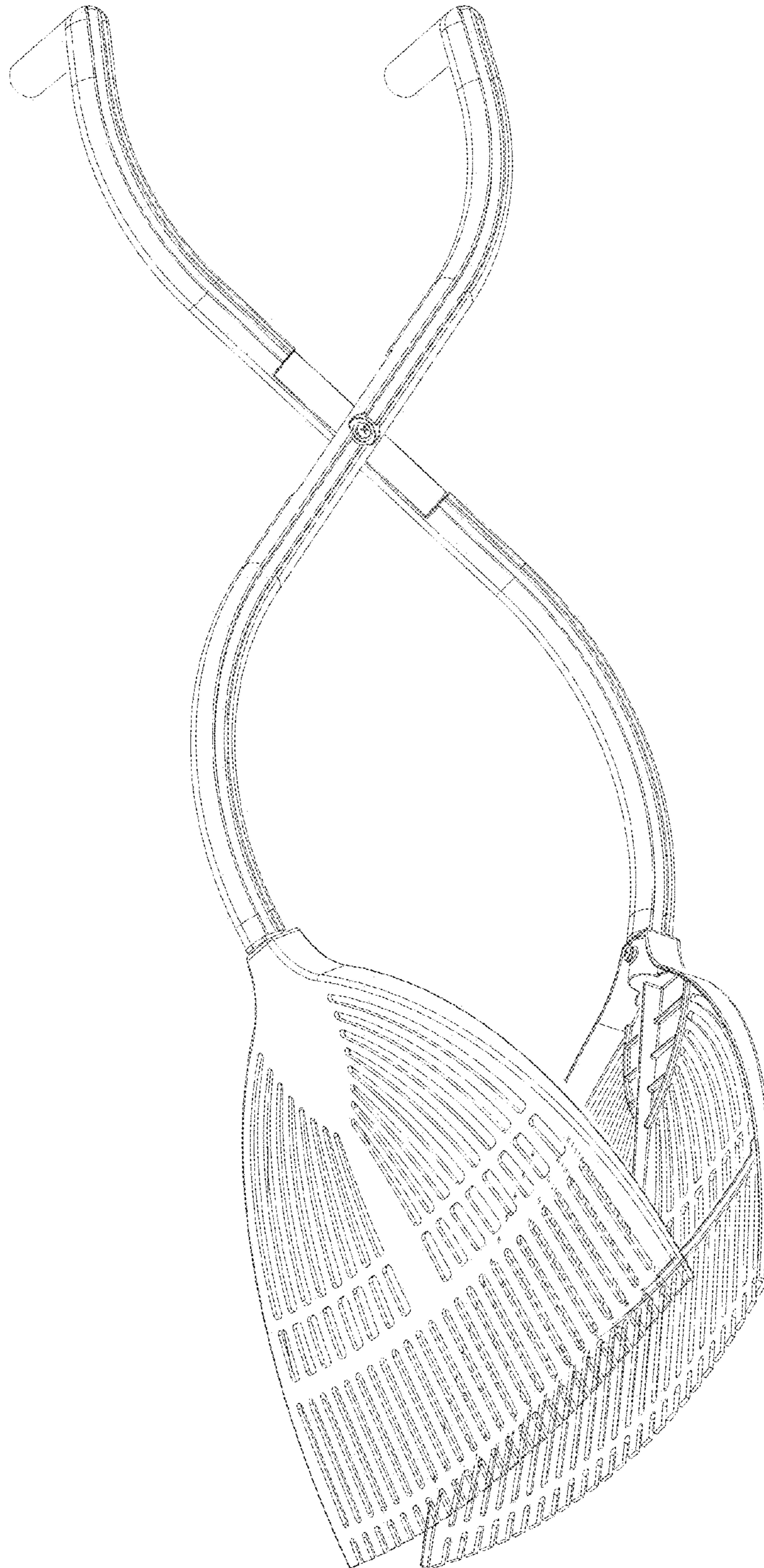

FIG. 14

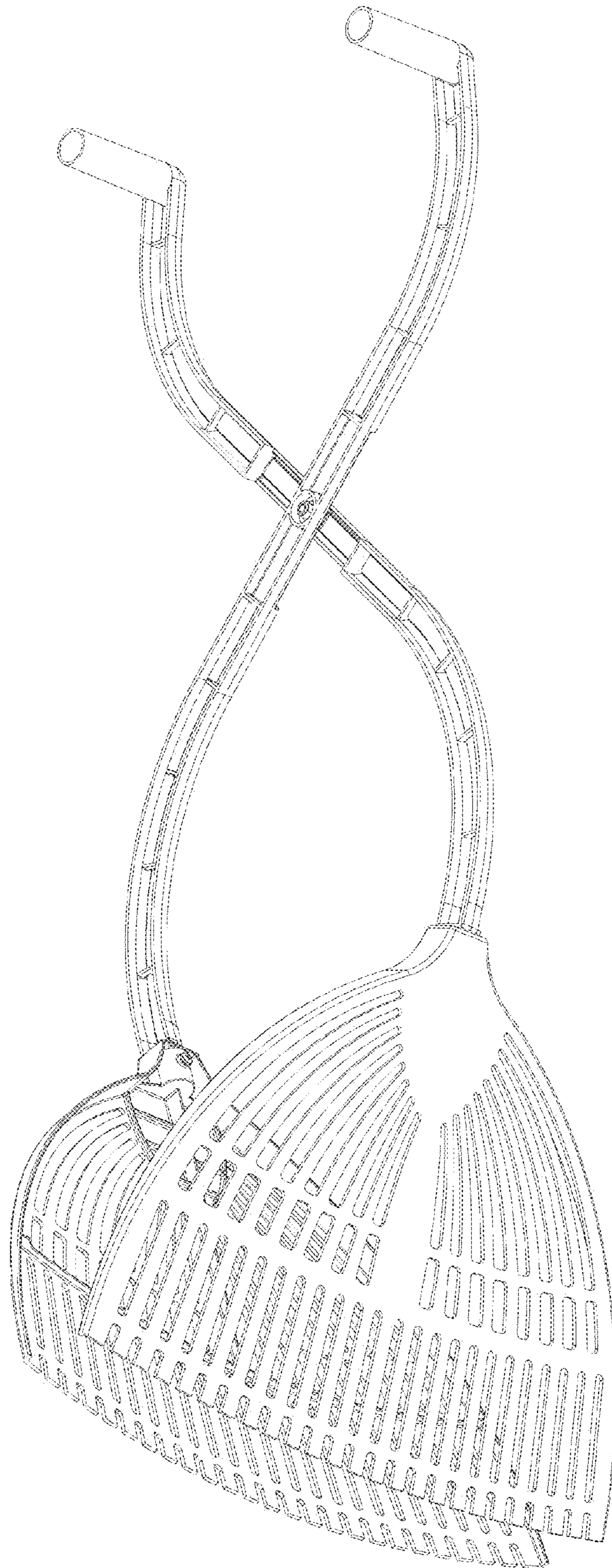

FIG. 15

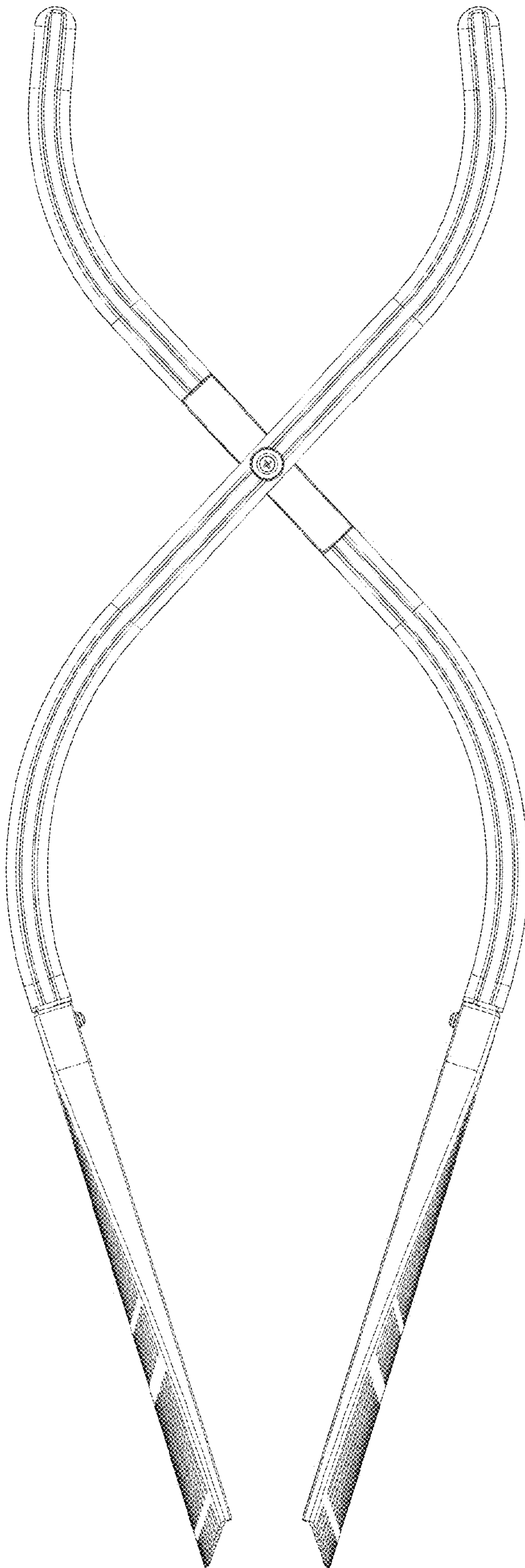

FIG. 16

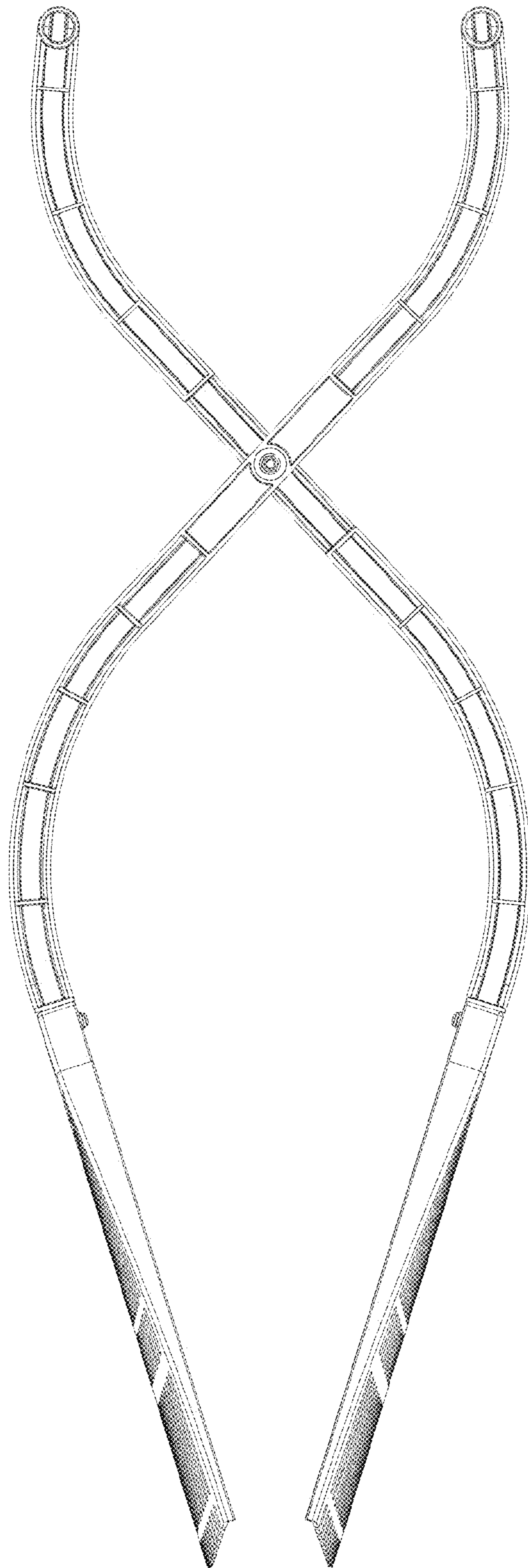

FIG. 17

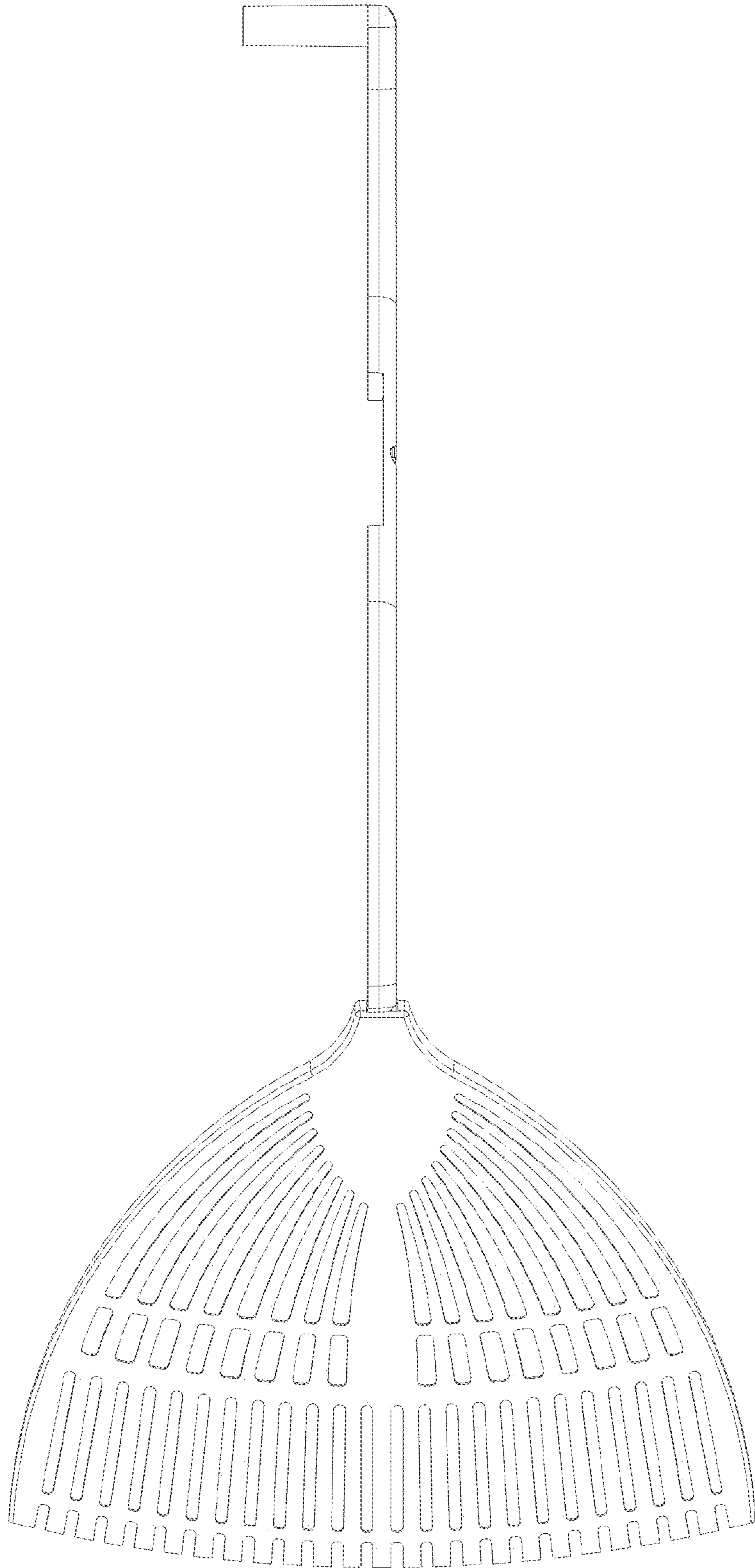

FIG. 18

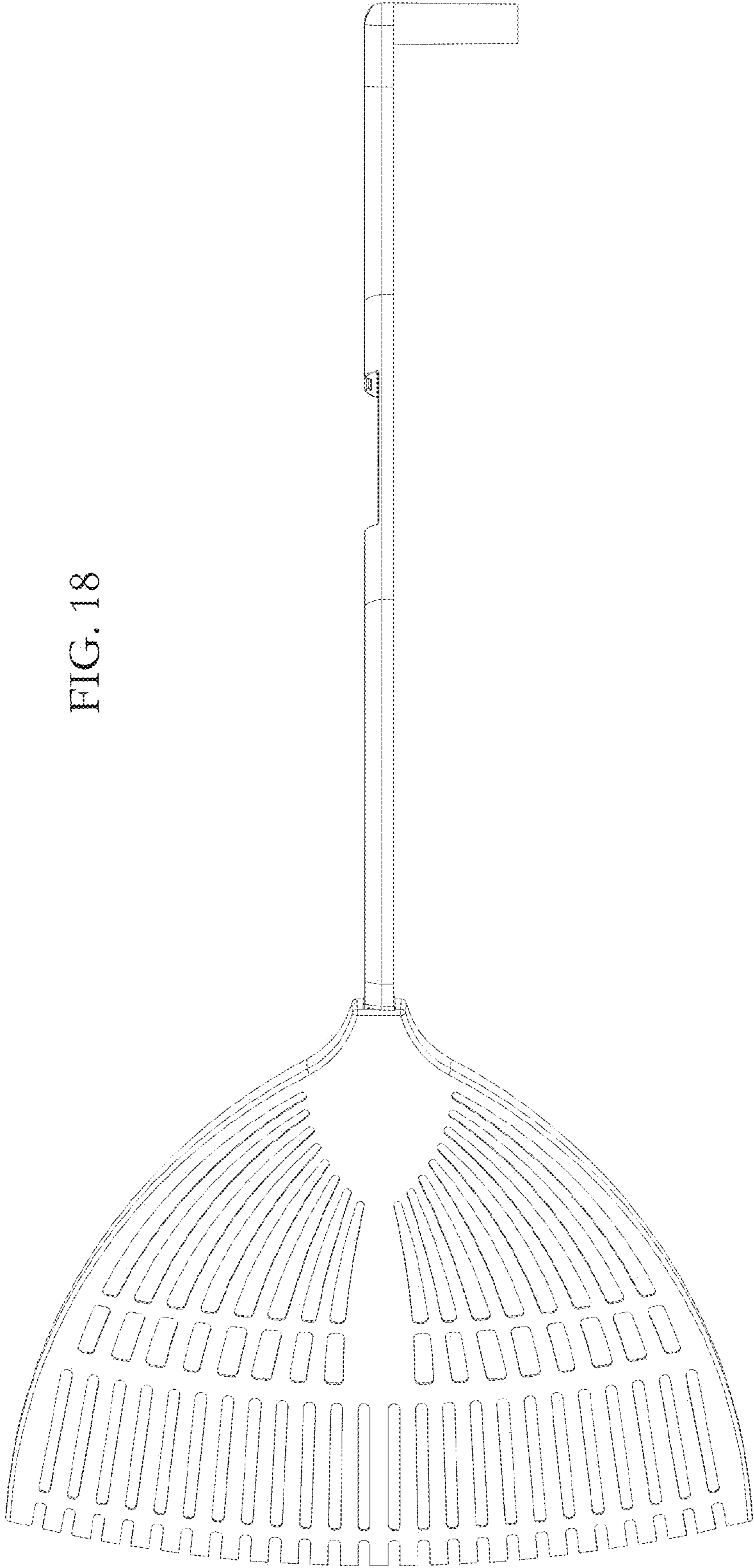

FIG. 19

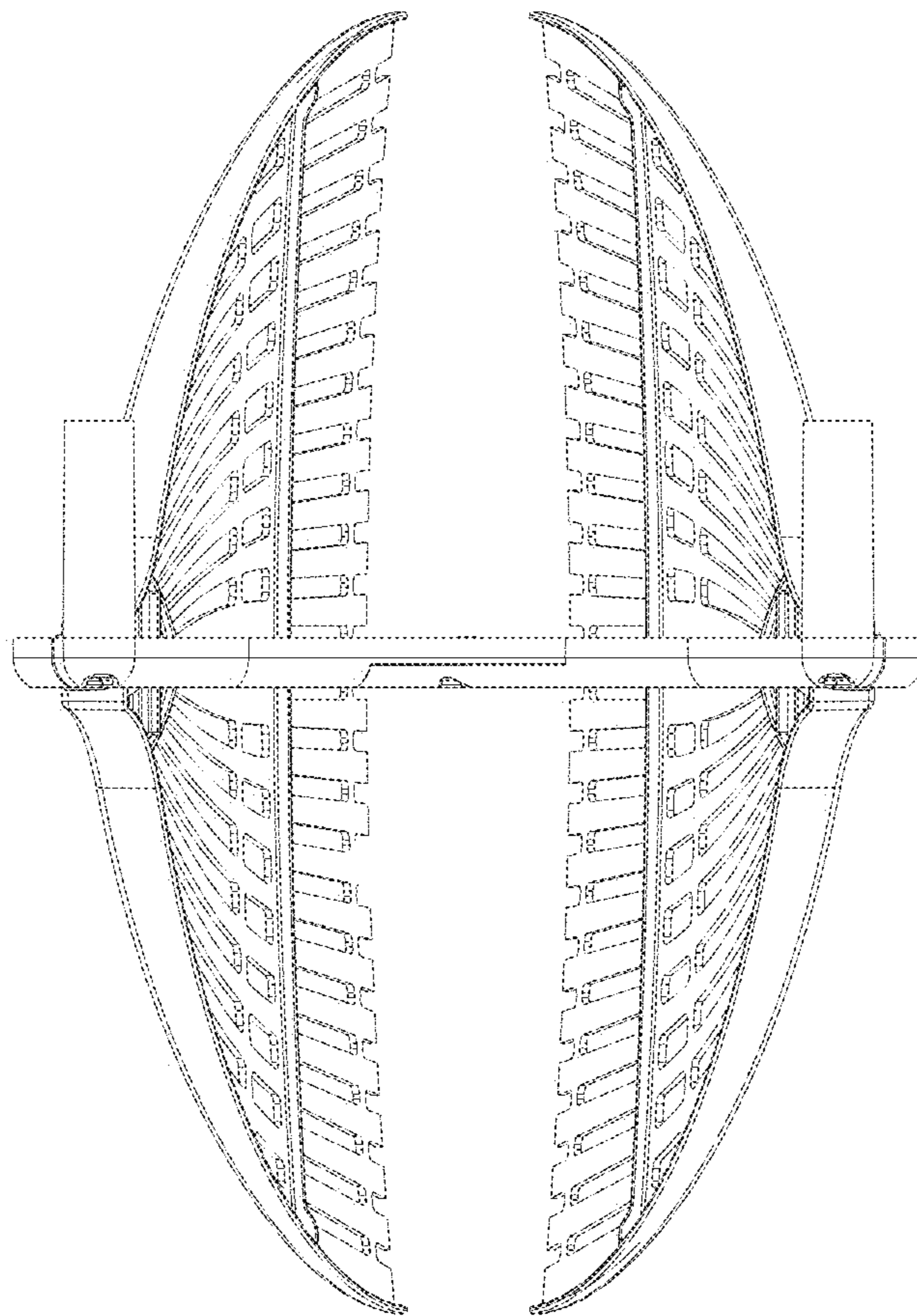

FIG. 20

