



US00D889834S

(12) **United States Design Patent**  
**Grecco**

(10) **Patent No.:** **US D889,834 S**

(45) **Date of Patent:** **\*\* Jul. 14, 2020**

(54) **STORAGE DEVICE FOR ELECTRONIC MEDIA**

D757,456 S \* 5/2016 Sheppard ..... D6/513  
D808,902 S \* 1/2018 Qiu ..... D13/108  
D810,458 S \* 2/2018 Cartier ..... D6/384

(Continued)

(71) Applicant: **Michael Grecco**, Santa Monica, CA  
(US)

*Primary Examiner* — Kevin K Rudzinski

(72) Inventor: **Michael Grecco**, Santa Monica, CA  
(US)

*Assistant Examiner* — Amber J Rabie

(74) *Attorney, Agent, or Firm* — John Laurence

(\*\*) Term: **15 Years**

(57) **CLAIM**

I claim the ornamental design for a storage device for electronic media, as shown and described.

(21) Appl. No.: **29/679,719**

**DESCRIPTION**

(22) Filed: **Feb. 8, 2019**

(51) **LOC (12) Cl.** ..... **09-04**

(52) **U.S. Cl.**  
USPC ..... **D3/313**

(58) **Field of Classification Search**  
USPC ..... D3/306, 307, 312, 313, 314  
CPC ..... A44B 18/0023  
See application file for complete search history.

FIG. 1 is a top perspective view;  
FIG. 2 is a bottom perspective view;  
FIG. 3 is a front plan view;  
FIG. 4 is a back plan view;  
FIG. 5 is a top plan view;  
FIG. 6 is a bottom plan view;  
FIG. 7 is a left-side view;  
FIG. 8 is a right-side view;  
FIG. 9 is a top perspective view of an alternate embodiment of our new design;  
FIG. 10 is a front view of the alternate embodiment of FIG. 9;  
FIG. 11 is a rear view of the alternate embodiment of FIG. 9;  
FIG. 12 is a top plan view of the alternate embodiment of FIG. 9;  
FIG. 13 is a bottom plan view of the inside of the alternate FIG. 9;  
FIG. 14 is a left-side view of the alternate embodiment of FIG. 9; and,  
FIG. 15 is a right-side view of the alternate embodiment of FIG. 9.

The broken lines disclaiming the compartments in the figures are for the purpose of illustrating the environment of the design only and form no part of the claimed design.

(56) **References Cited**

**U.S. PATENT DOCUMENTS**

809,741 A \* 1/1906 Payne ..... A47B 47/025  
312/234.4  
1,868,070 A \* 7/1932 Newman ..... F25C 1/24  
249/133  
D216,604 S \* 2/1970 Brindley ..... D3/313  
D218,161 S \* 7/1970 Kadison ..... D6/572  
3,734,279 A \* 5/1973 Fisher, Jr. .... B65D 71/70  
206/564  
D238,536 S \* 1/1976 Scherzer ..... D6/705  
D338,792 S \* 8/1993 Chap ..... D30/120  
D385,132 S \* 10/1997 Sagol ..... D6/675.1  
D401,085 S \* 11/1998 Grant ..... D6/675.1  
6,877,231 B2 \* 4/2005 Rosenberg ..... A47G 21/14  
248/37.3  
D629,232 S \* 12/2010 Forcellina ..... D6/675.1  
D648,940 S \* 11/2011 Britt ..... D3/313  
D719,253 S \* 12/2014 Francescon ..... D23/388

**1 Claim, 11 Drawing Sheets**

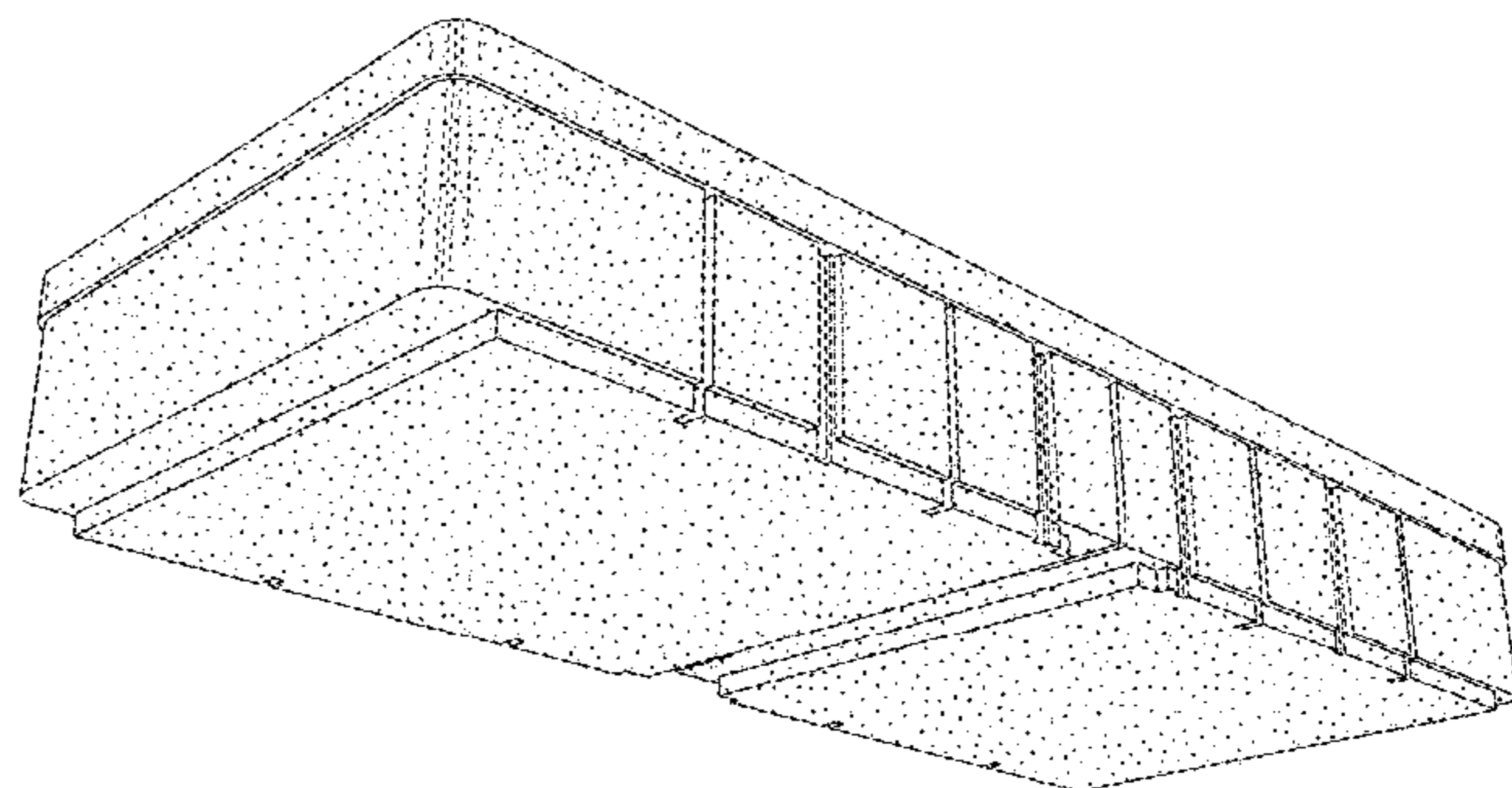
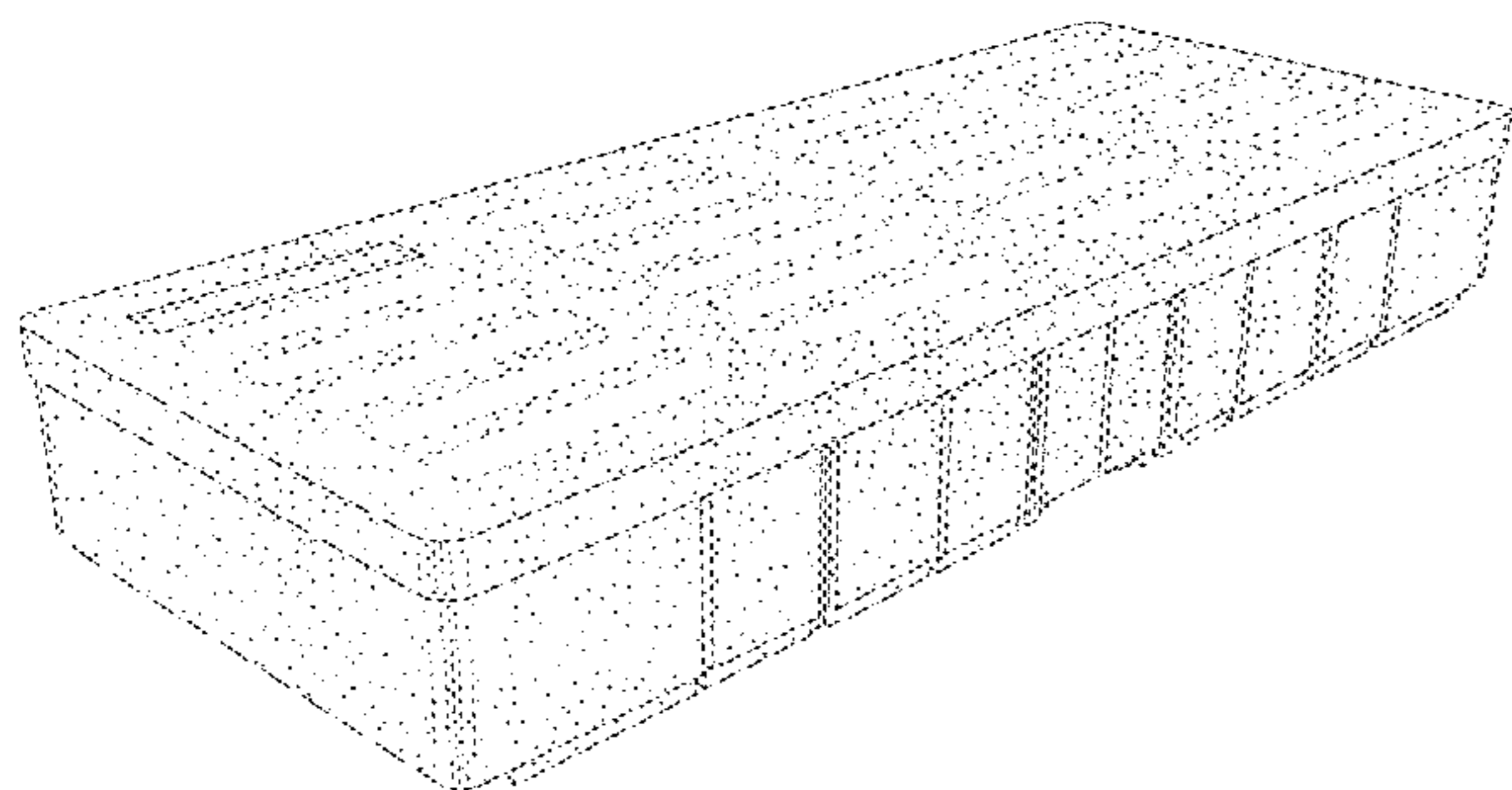

(56)

**References Cited**

U.S. PATENT DOCUMENTS

D811,088 S \* 2/2018 Grecco ..... D3/313  
D852,017 S \* 6/2019 Kao ..... D8/71

\* cited by examiner

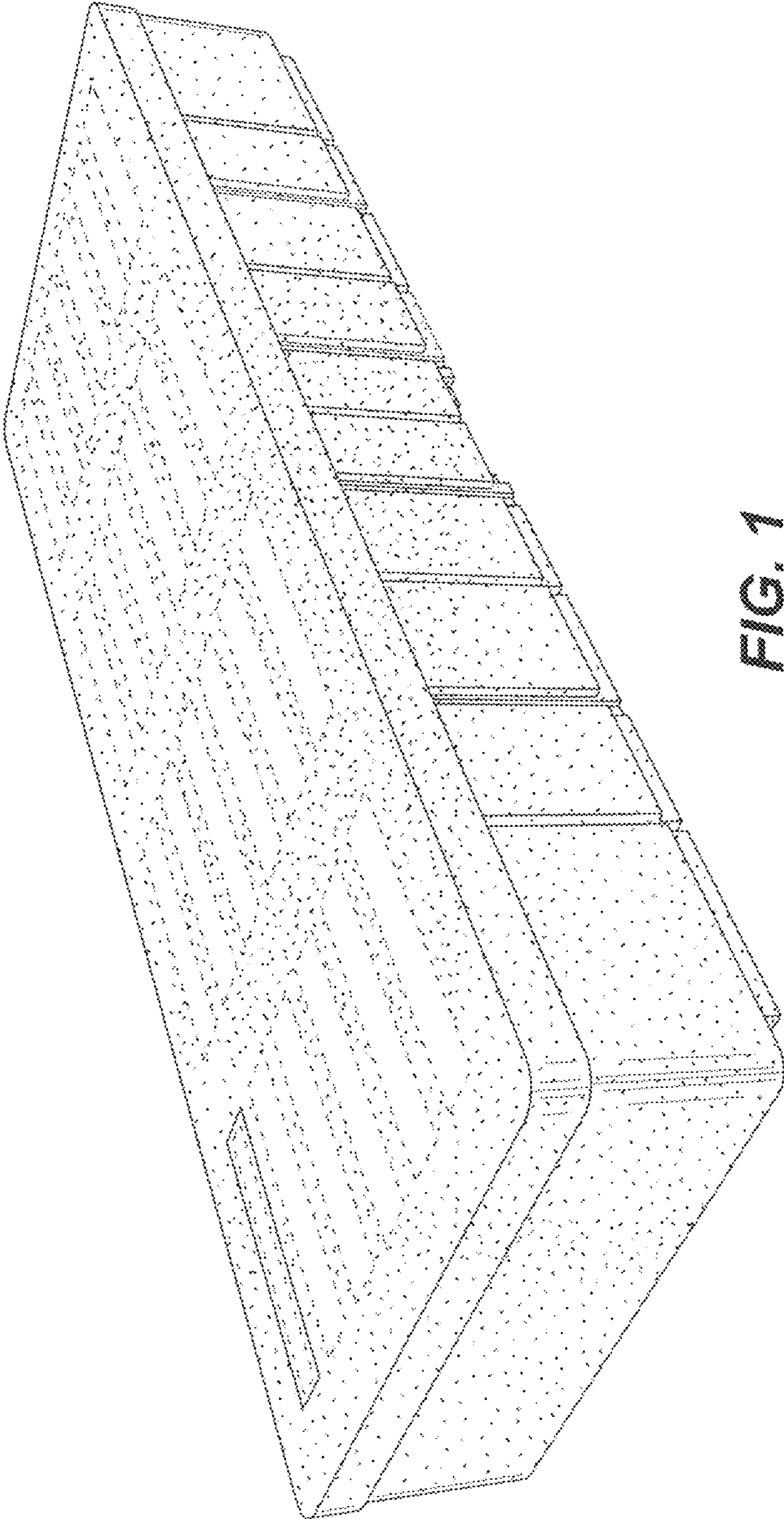
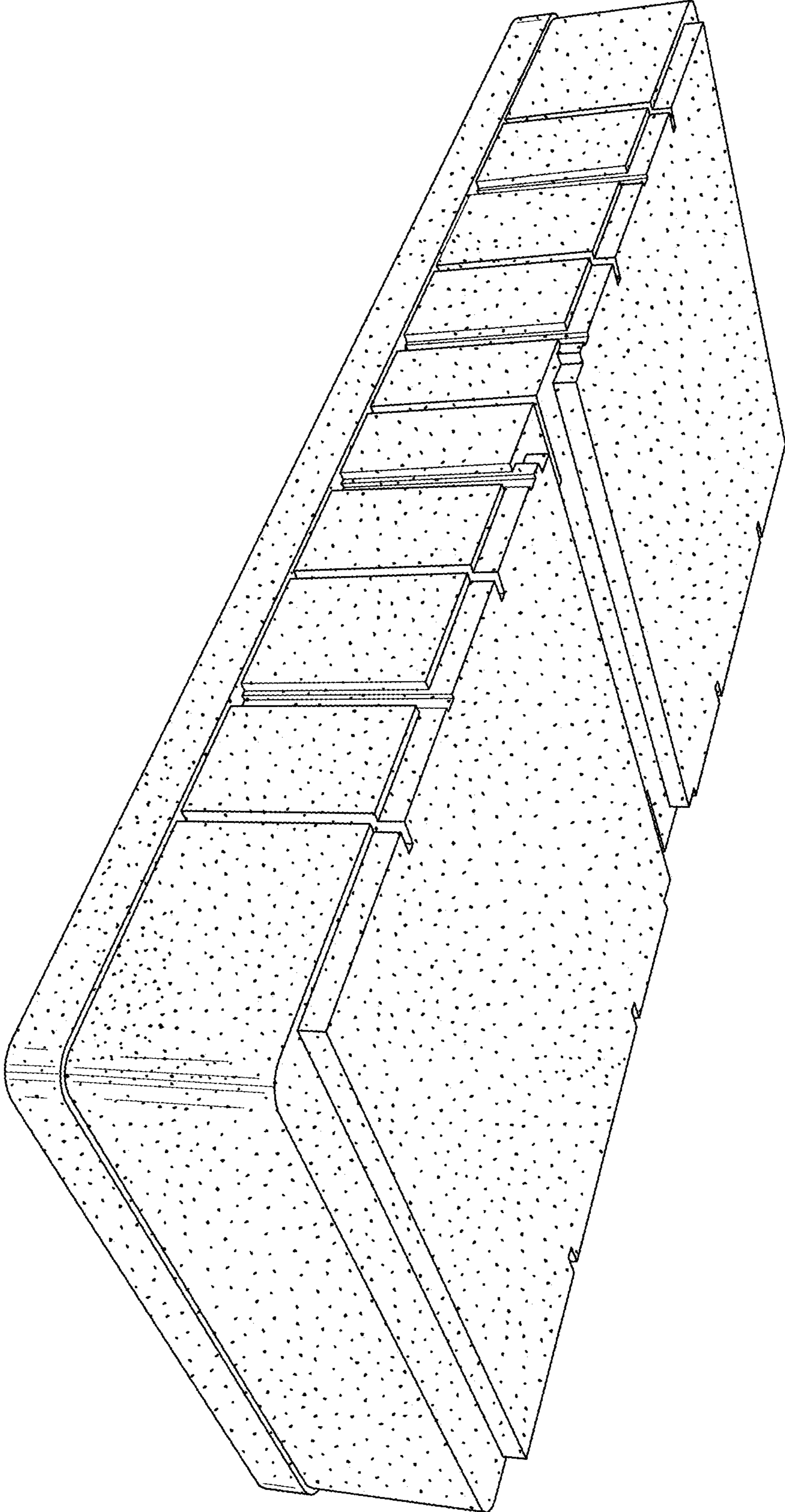
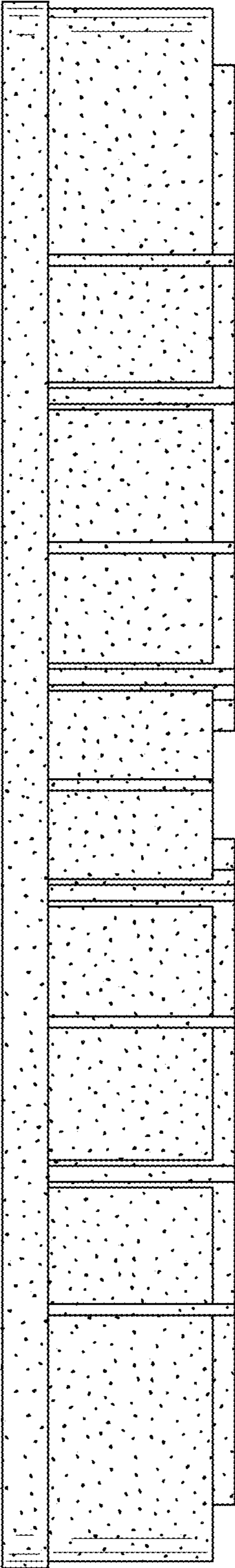

FIG. 1

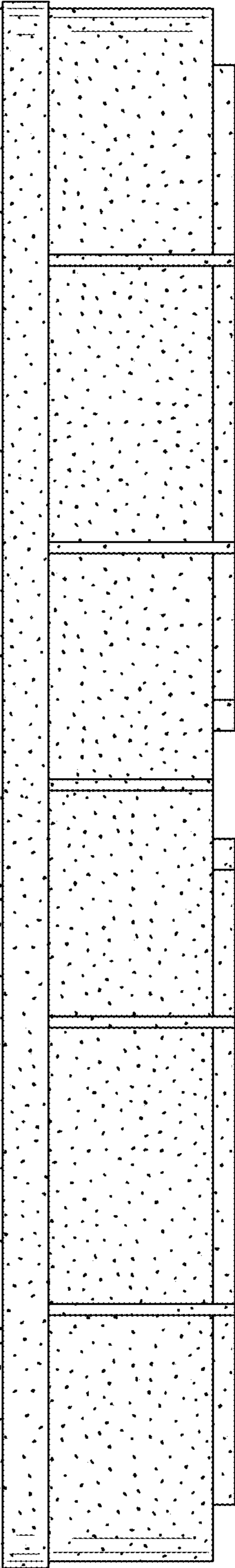



**FIG. 2**



**FIG. 3**



**FIG. 4**

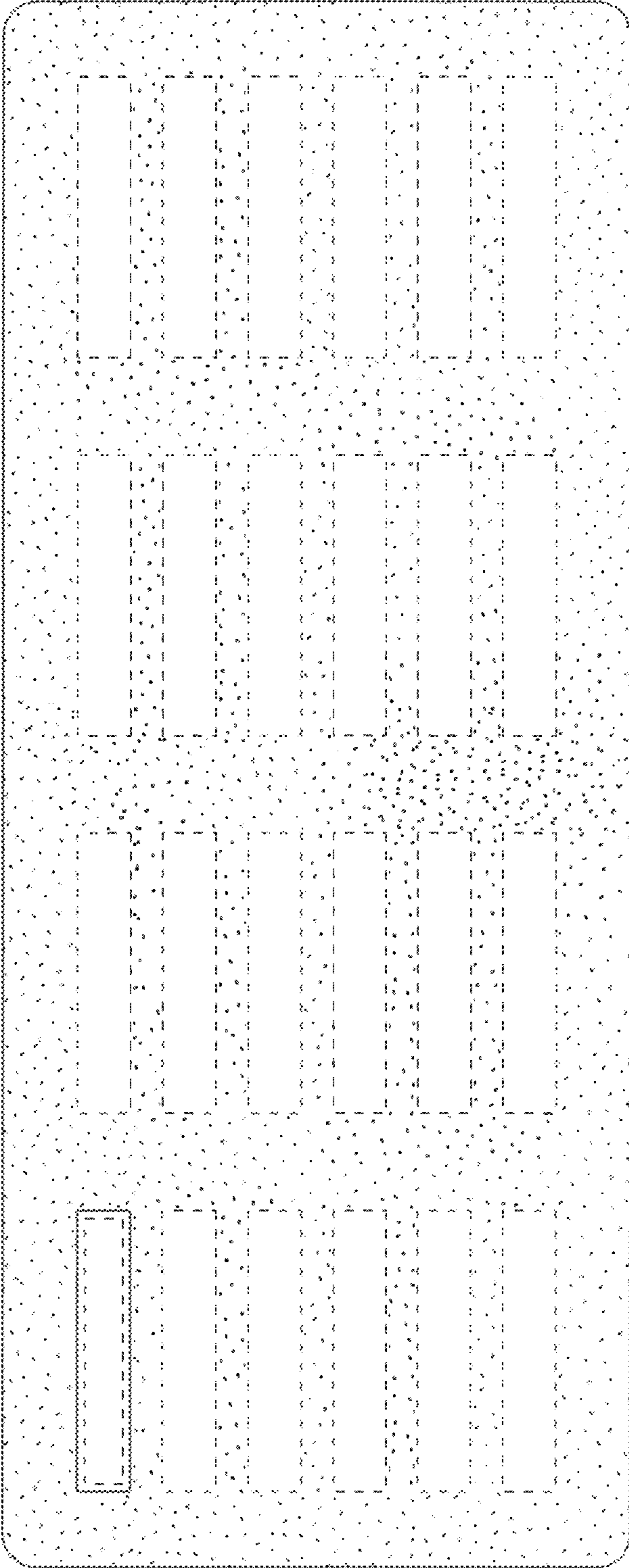

FIG. 5

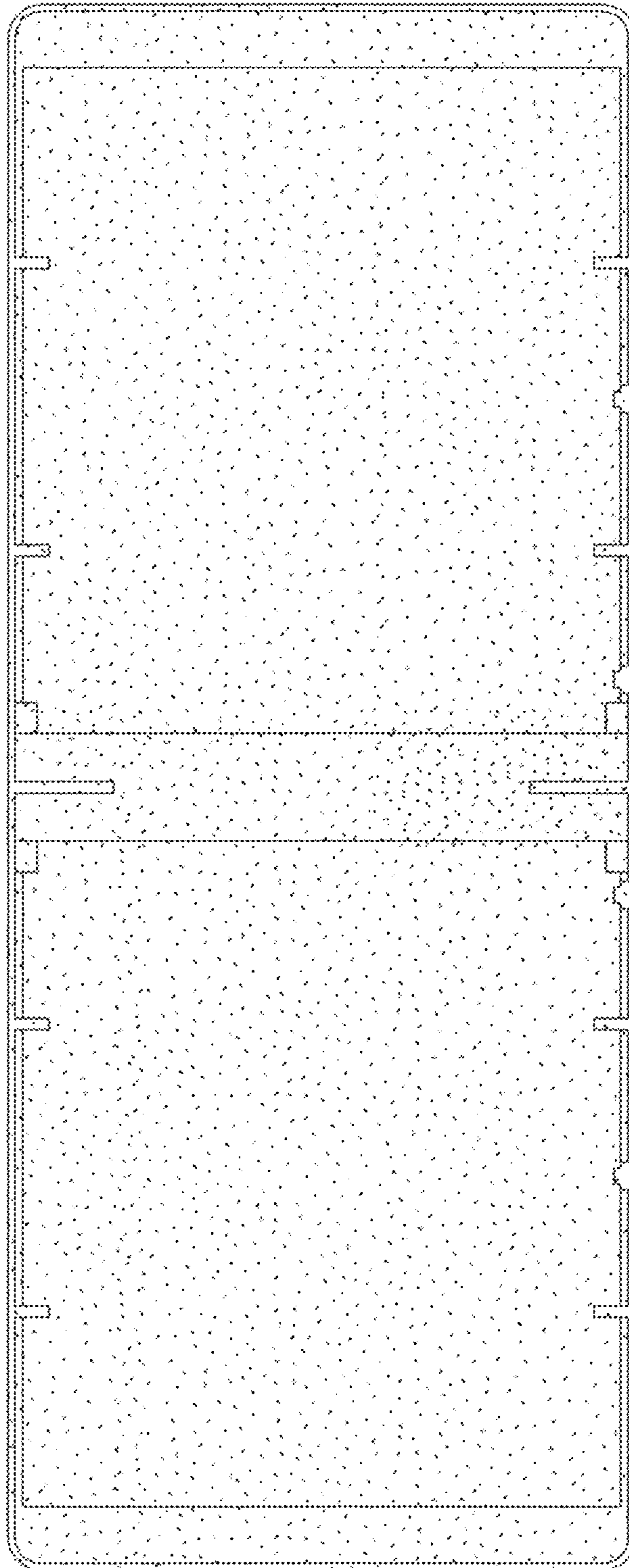
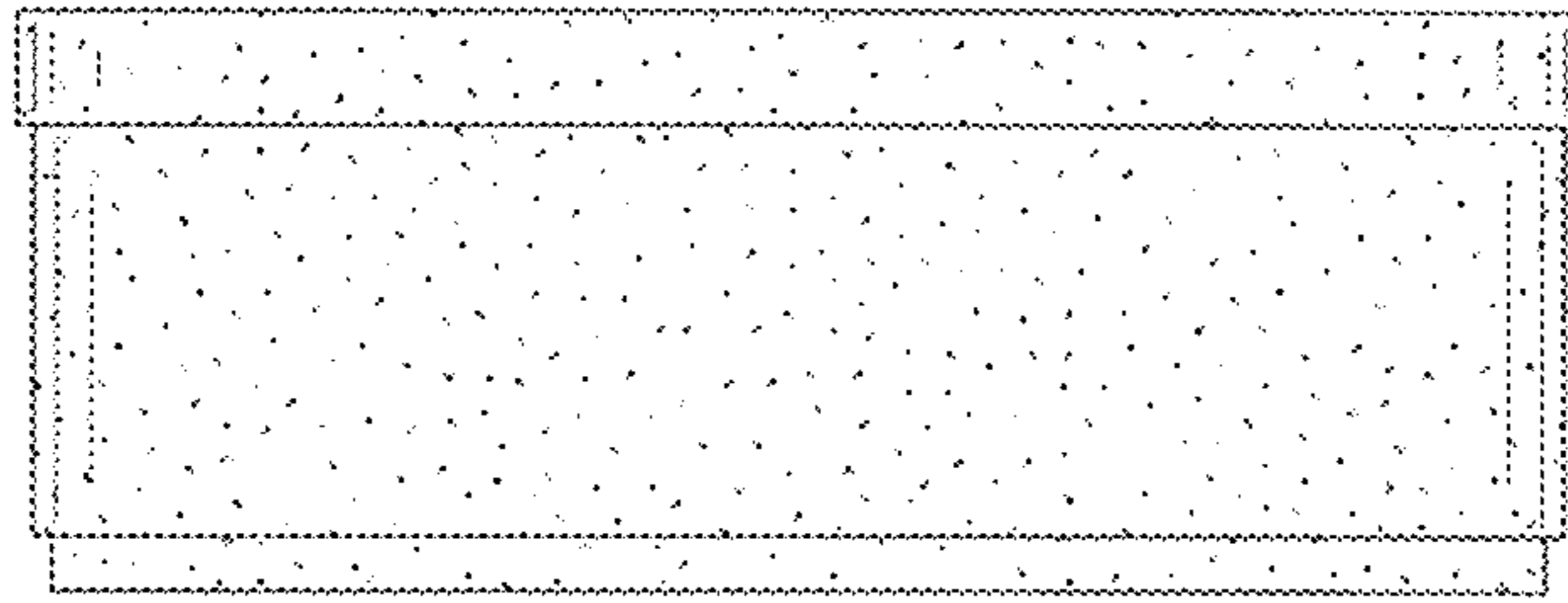
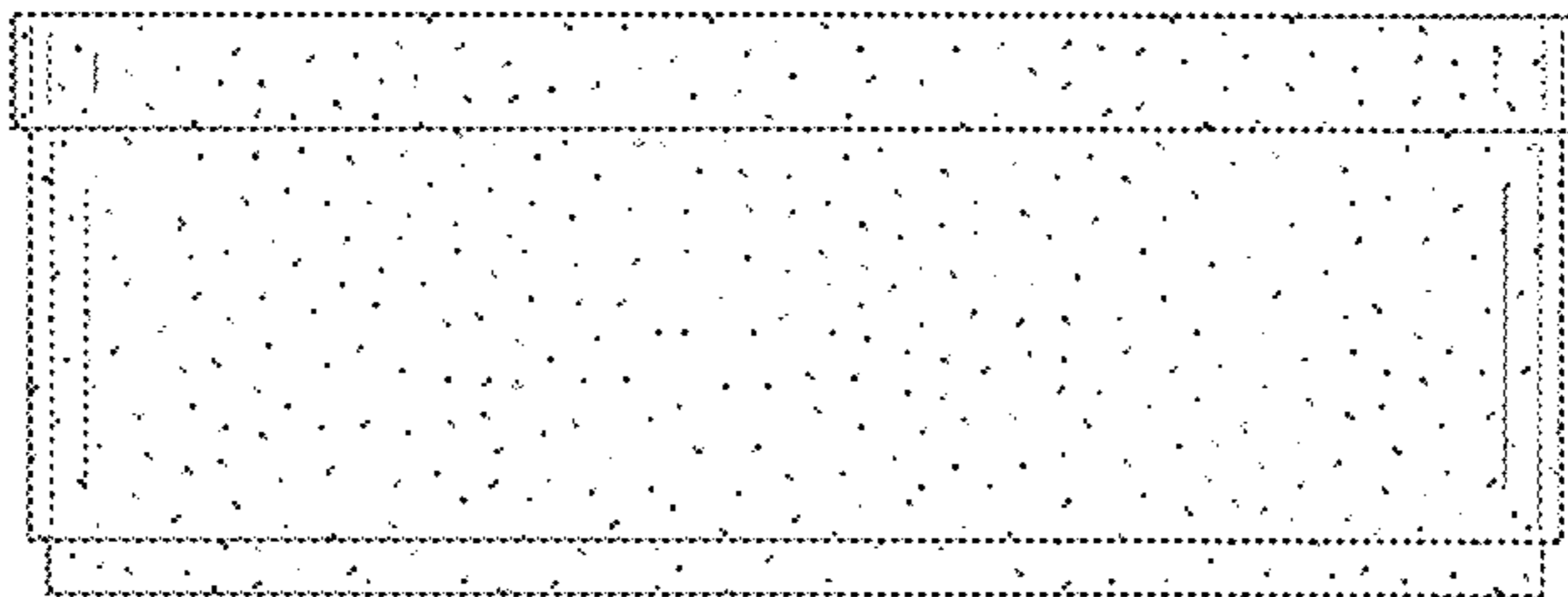

FIG. 6





**FIG. 7**



**FIG. 8**



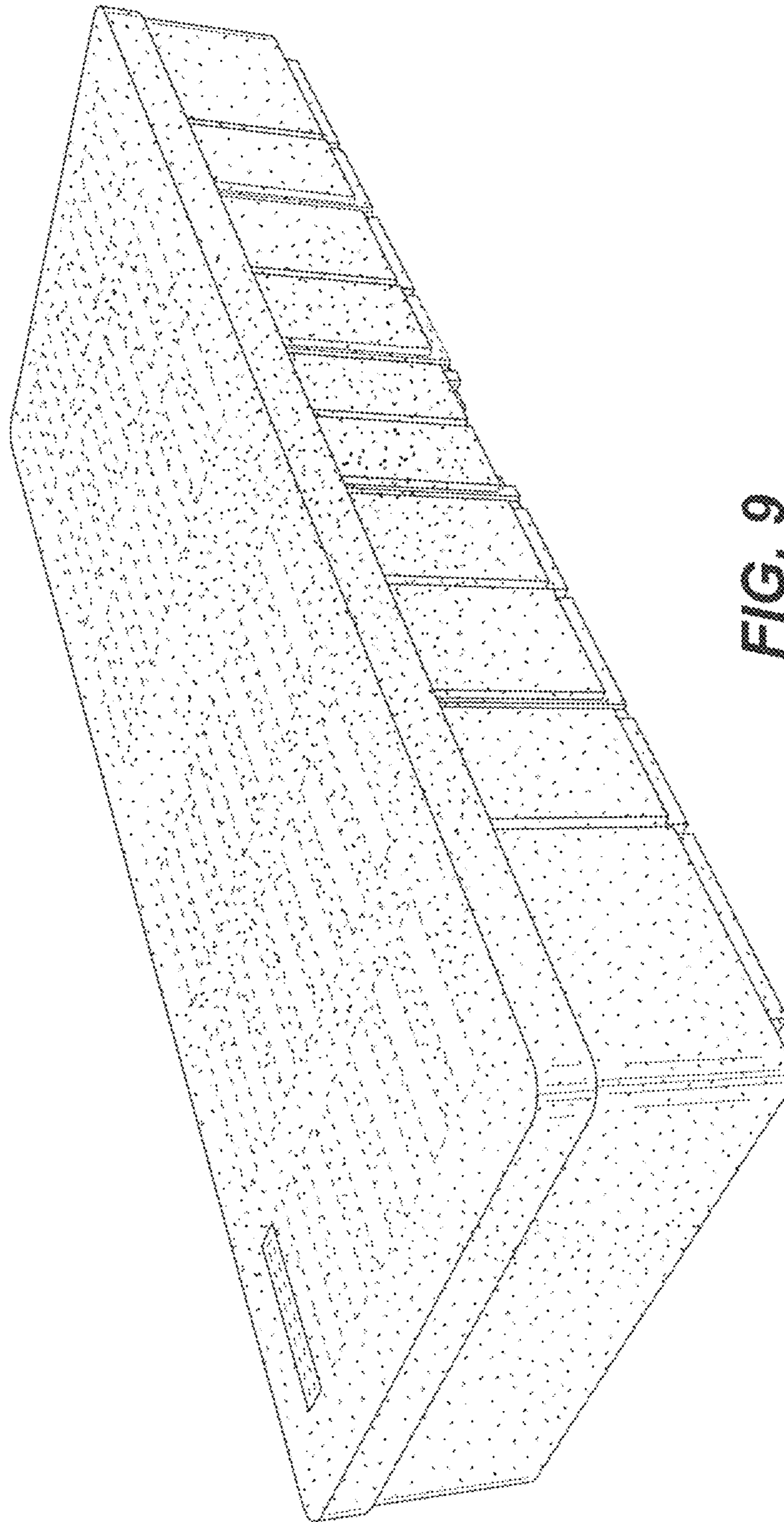
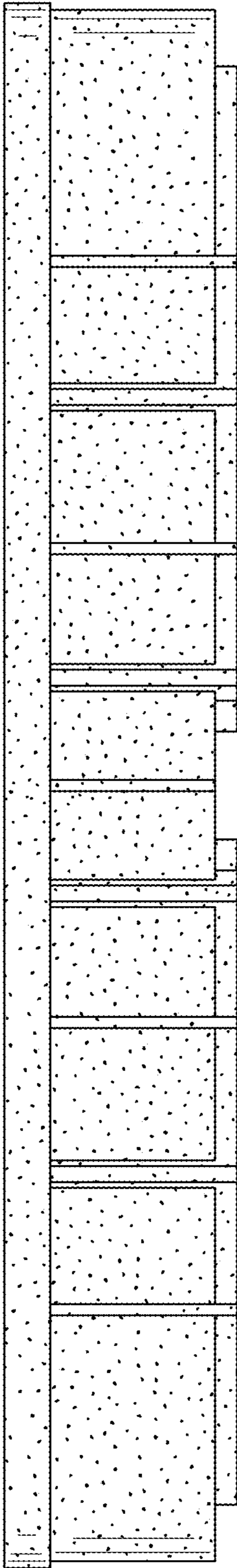
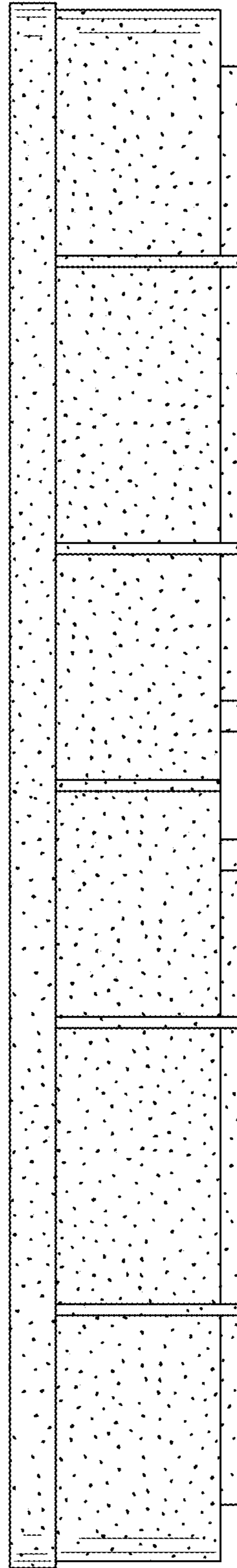

FIG. 9



**FIG. 10**



**FIG. 11**

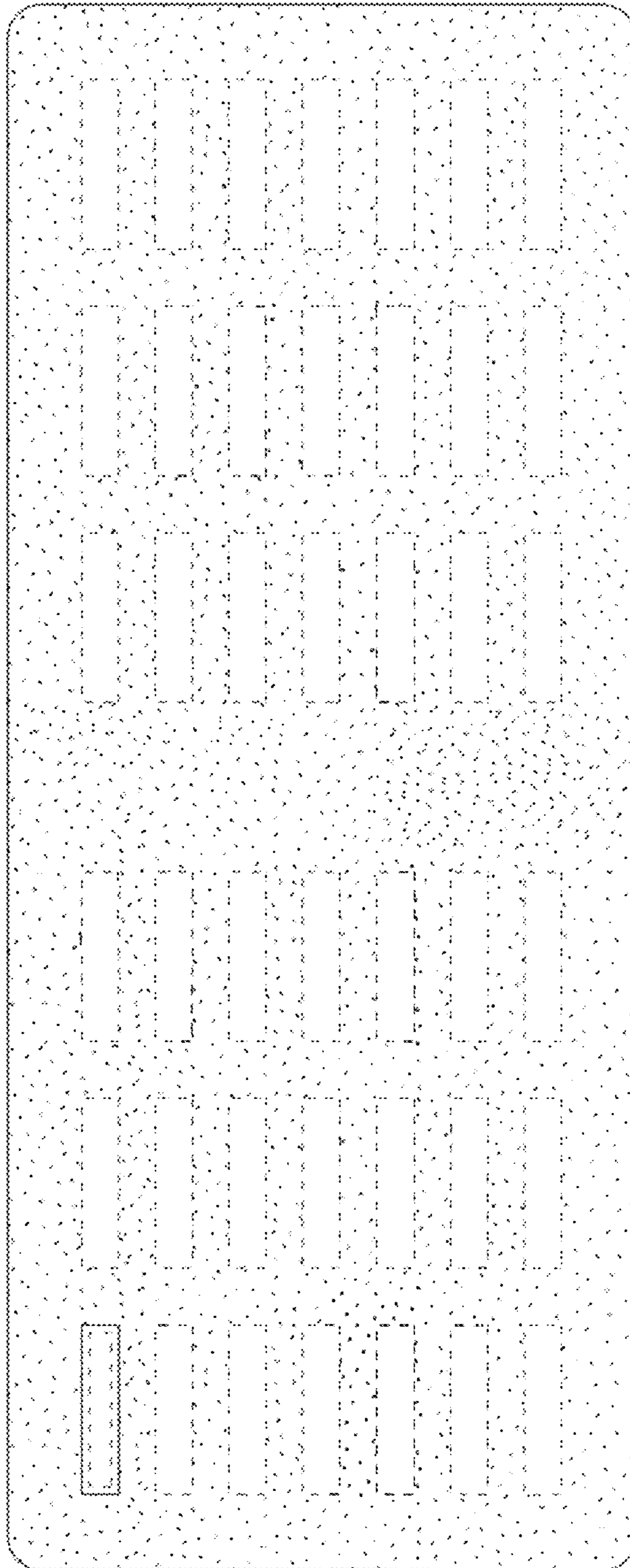

FIG. 12

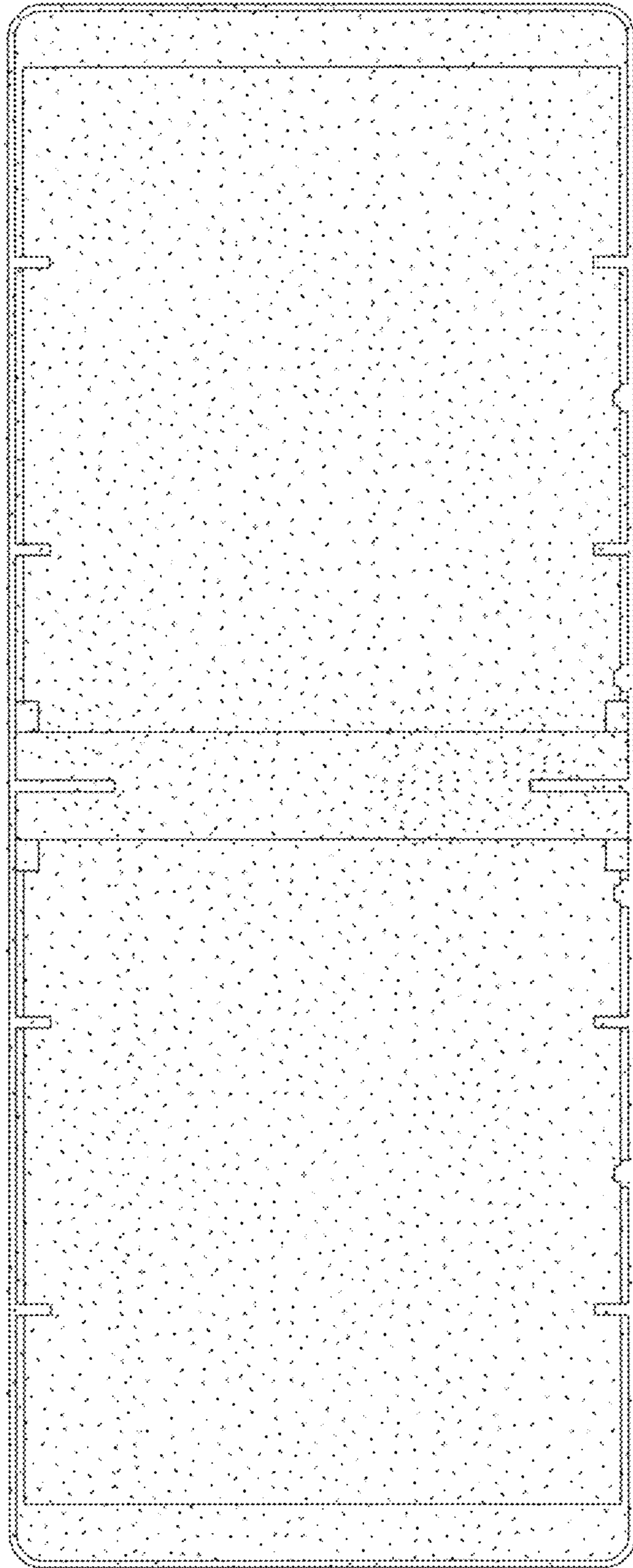
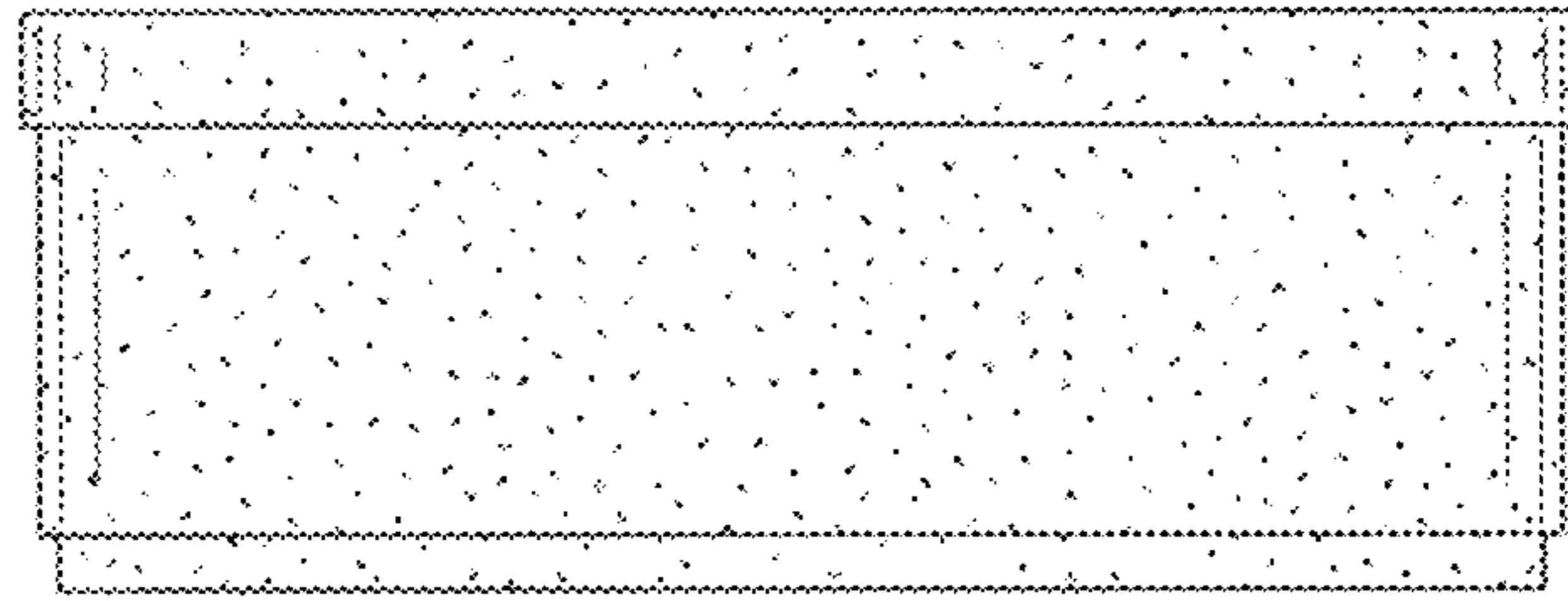
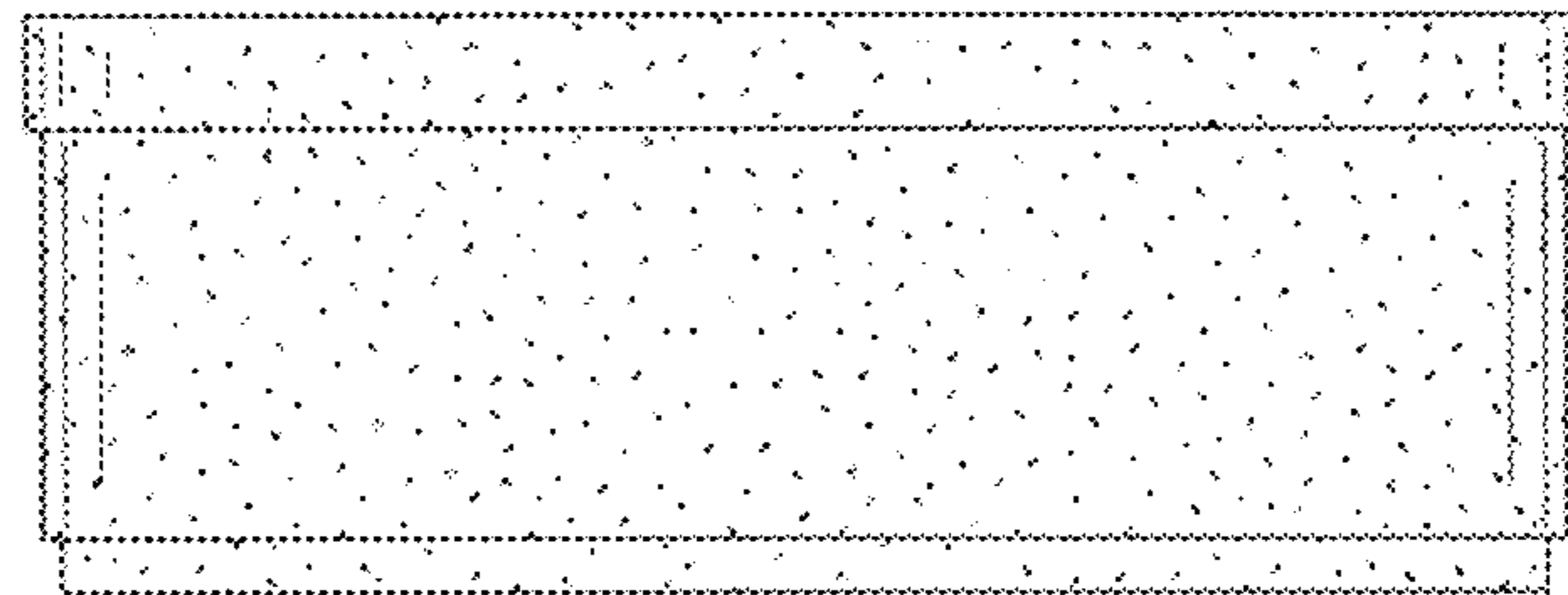

FIG. 13





**FIG. 14**



**FIG. 15**