



US00D889798S

(12) **United States Design Patent**  
**Vella**

(10) **Patent No.:** **US D889,798 S**  
(45) **Date of Patent:** **\*\* Jul. 14, 2020**

(54) **SHOE**  
(71) Applicant: **PUMA SE**, Herzogenaurach (DE)  
(72) Inventor: **Chris Vella**, Cambridge, MA (US)  
(73) Assignee: **PUMA SE**, Herzogenaurach (DE)  
(\*\*) Term: **15 Years**  
(21) Appl. No.: **29/681,149**

(22) Filed: **Feb. 22, 2019**  
(51) **LOC (12) Cl.** ..... **02-04**  
(52) **U.S. Cl.**  
USPC ..... **D2/960; D2/947; D2/951; D2/956;**  
**D2/959**

(58) **Field of Classification Search**  
USPC ..... D2/902, 906, 908, 916, 918, 925,  
D2/946-962, 977; 36/1, 1.5, 3 B, 22 R,  
36/24.5, 25 R, 28, 32 R, 34 R, 59 C,  
36/67 A, 101-107, 114-116, 117.3, 117.4,  
36/124-136  
CPC ..... A43B 13/00; A43B 13/02; A43B 13/023;  
A43B 13/026; A43B 13/04; A43B 13/08;  
A43B 13/10; A43B 13/12; A43B 13/14;  
A43B 13/141; A43B 13/143; A43B  
13/16; A43B 13/18; A43B 13/181; A43B  
13/187; A43B 13/189; A43B 13/20; A43B  
13/22; A43B 13/223; A43B 13/24; A43B  
13/28; A43B 13/30; A43B 13/32; A43B  
13/34; A43B 13/36  
See application file for complete search history.

(56) **References Cited**  
U.S. PATENT DOCUMENTS

2,090,881 A 8/1937 Wilson  
D237,323 S 10/1975 Inohara  
D244,967 S 7/1977 Famolare, Jr.  
4,089,069 A 5/1978 Vistins  
D263,348 S 3/1982 Cohen

D263,518 S 3/1982 Cohen  
D265,019 S 6/1982 Vermonet  
4,345,387 A 8/1982 Daswick  
(Continued)

FOREIGN PATENT DOCUMENTS

CN 303732506 S 7/2016  
EM 002219956-0020 S 4/2013

OTHER PUBLICATIONS

Persist XT Knit Men's Training Shoes, Puma.com, [online], [site visited Mar. 24, 2020]. <URL: [https://us.puma.com/en/us/pd/persist-xt-knit-men%E2%80%99s-training-shoes/192616.html?dwvar\\_192616\\_color=03](https://us.puma.com/en/us/pd/persist-xt-knit-men%E2%80%99s-training-shoes/192616.html?dwvar_192616_color=03)> (Year: 2020).  
(Continued)

*Primary Examiner* — T Chase Nelson  
*Assistant Examiner* — Jonathan J. Han  
(74) *Attorney, Agent, or Firm* — Quarles & Brady LLP

(57) **CLAIM**

The ornamental design for a shoe, as shown and described.

**DESCRIPTION**

FIG. 1 is a top, right, and front perspective view of an ornamental design for a shoe;  
FIG. 2 is a front elevational view of the shoe of FIG. 1;  
FIG. 3 is a rear elevational view of the shoe of FIG. 1;  
FIG. 4 is a right side elevational view of the shoe of FIG. 1;  
FIG. 5 is a left side elevational view of the shoe of FIG. 1;  
FIG. 6 is a top plan view of the shoe of FIG. 1;  
FIG. 7 is a bottom plan view of the shoe of FIG. 1; and,  
FIG. 8 is a bottom, left, and rear perspective view of the shoe of FIG. 1.  
The dash-dash-dash broken lines are included for the purpose of illustrating portions of the shoe that form no part of the claimed design.

**1 Claim, 7 Drawing Sheets**

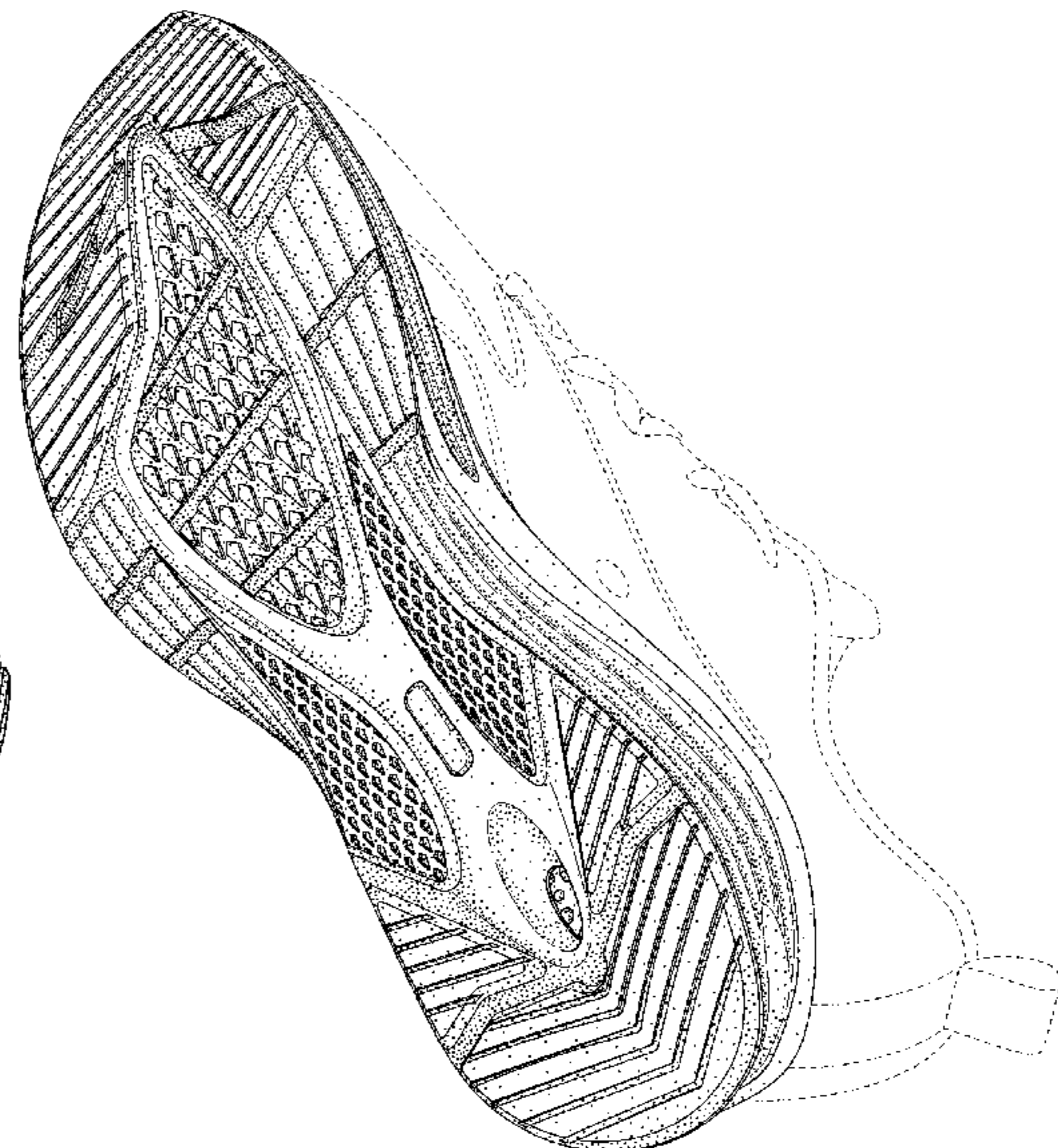
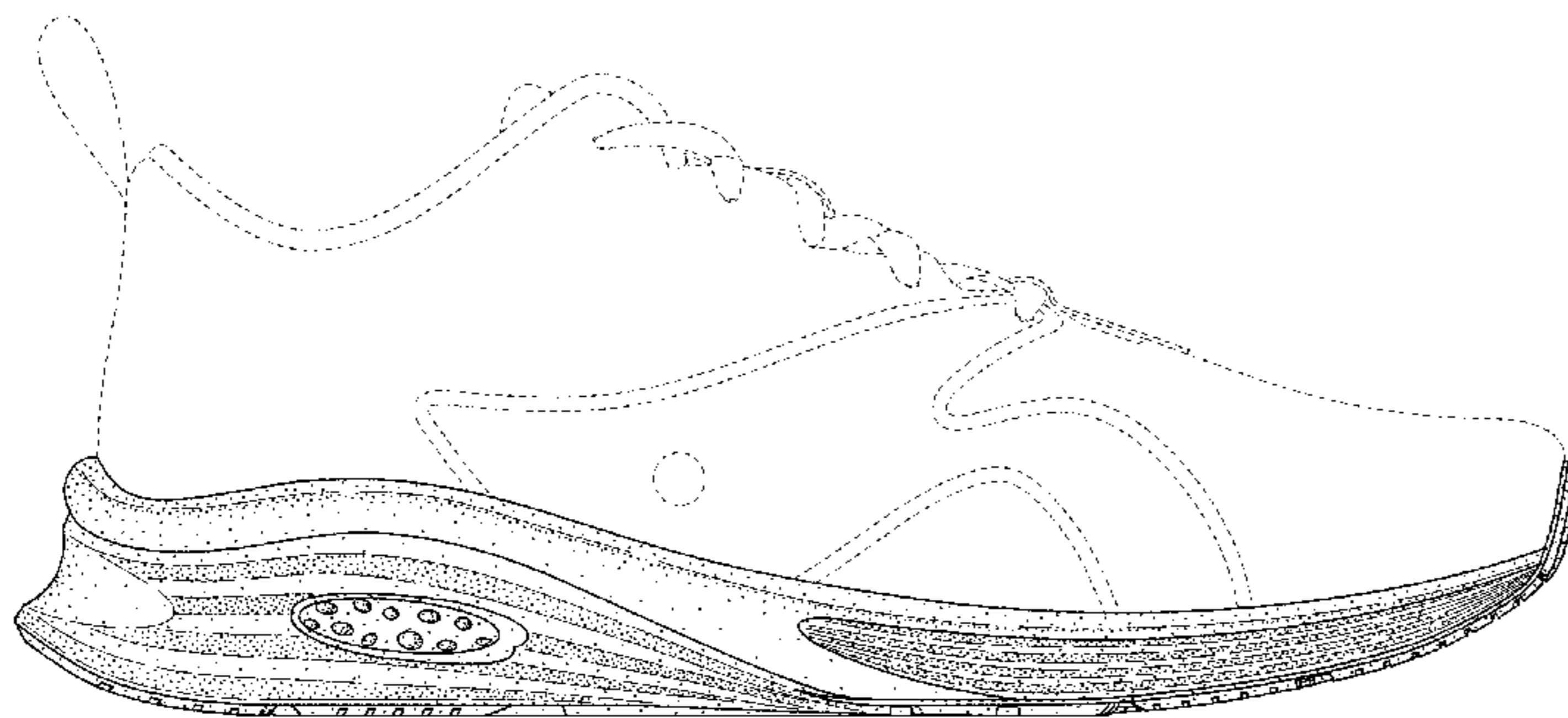



(56)

References Cited

U.S. PATENT DOCUMENTS

4,378,641 A	4/1983	Tarlow	D581,634 S	12/2008	Hickman	
D297,682 S	9/1988	Le	D586,090 S	2/2009	Turner et al.	
D305,278 S	1/1990	Kiyosawa	D596,384 S	7/2009	Andersen et al.	
D306,372 S	3/1990	Diaz et al.	D597,286 S	8/2009	Della Valle et al.	
D307,971 S	5/1990	Maccano et al.	D601,333 S	10/2009	McClaskie	
D319,337 S	8/1991	Hatfield	D606,733 S	12/2009	McClaskie	
D321,973 S	12/1991	Hatfield	D607,190 S	1/2010	McClaskie	
D323,059 S	1/1992	Hatfield	D607,634 S	1/2010	Andersen et al.	
D327,164 S	6/1992	Hatfield	7,703,219 B2	4/2010	Beck	
D327,976 S	7/1992	Biotteau	D631,239 S	1/2011	Loverin et al.	
D329,528 S	9/1992	Hatfield	D631,646 S	2/2011	Muller	
D334,279 S	3/1993	Teague	D633,286 S	3/2011	Skaja	
D350,222 S	9/1994	Hase	D634,918 S	3/2011	Katz et al.	
D353,708 S	12/1994	Crowley, II	D636,571 S	4/2011	Avar	
D353,935 S	1/1995	Pollack	D636,588 S	4/2011	Avar	
D356,438 S	3/1995	Opie et al.	D641,142 S	7/2011	Lindseth et al.	
D357,347 S	4/1995	Leick	D642,777 S	8/2011	Walsh et al.	
D373,013 S	8/1996	Rosetta	D644,418 S *	9/2011	Yi .....	D2/946
D379,113 S	5/1997	McDonald et al.	D645,649 S	9/2011	McClaskie	
D379,114 S	5/1997	Merceron	D645,650 S	9/2011	McClaskie	
D382,692 S	8/1997	Carlson	D650,567 S	12/2011	Badegruber	
D389,991 S	2/1998	Elliott	D655,487 S	3/2012	Blakeslee	
D390,349 S	2/1998	Murai et al.	D662,695 S *	7/2012	McVicker .....	D2/902
D391,748 S	3/1998	Koh	D663,933 S	7/2012	Lane	
D392,446 S	3/1998	Fogg	D664,340 S	7/2012	McClaskie	
D393,538 S	4/1998	Marshall	D664,750 S	8/2012	McClaskie	
D394,342 S	5/1998	Schneider	D666,392 S *	9/2012	Shaffer .....	D2/951
D394,742 S	6/1998	Gaudio	D671,718 S *	12/2012	McVicker .....	D2/908
D394,945 S	6/1998	Doxey	D672,543 S *	12/2012	Williams, Jr. ....	D2/951
D395,738 S	7/1998	Hatfield et al.	D680,710 S	4/2013	Sundberg	
D414,920 S	10/1999	Cahill	D684,343 S	6/2013	Sundberg	
D415,610 S	10/1999	Cahill	D684,344 S	6/2013	Sundberg	
6,035,554 A	3/2000	Duncan	8,533,977 B2 *	9/2013	Hide .....	A43B 13/187 36/30 R
D423,199 S	4/2000	Cahill	D690,490 S	10/2013	Riddell	
D424,287 S	5/2000	Edwards	D693,553 S	11/2013	McClaskie	
D429,874 S	8/2000	Gumbert	D702,031 S *	4/2014	Nakano .....	D2/951
D432,294 S	10/2000	Wilson	D708,829 S	7/2014	Taylor	
D433,560 S	11/2000	Pawlus	D709,680 S	7/2014	Herath	
6,187,837 B1	2/2001	Pearce	D710,078 S	8/2014	Joseph	
6,199,302 B1	3/2001	Kayano	D713,624 S	9/2014	Petrie	
D440,032 S	4/2001	Madden	D717,033 S *	11/2014	Law .....	D2/951
D441,519 S	5/2001	Erickson et al.	D721,478 S	1/2015	Avent et al.	
D444,620 S	7/2001	Della Valle	D722,425 S	2/2015	Cin	
D445,561 S	7/2001	Bramani	D724,296 S *	3/2015	Law .....	D2/951
D447,616 S	9/2001	Bandini et al.	D728,912 S	5/2015	Taestensen	
6,314,661 B1	11/2001	Chern	D729,393 S	5/2015	Dunn et al.	
D460,852 S	7/2002	Daudier	D733,411 S	7/2015	Lonigan	
D465,079 S	11/2002	Merceron	D733,412 S	7/2015	Lonigan	
D466,272 S	12/2002	Erickson et al.	D733,413 S	7/2015	Joseph	
D494,343 S	8/2004	Morris	D734,006 S	7/2015	Portzline	
D496,149 S	9/2004	Belley et al.	D735,983 S	8/2015	Cietto	
D496,525 S *	9/2004	Dykstra .....	D737,548 S	9/2015	Levy	
D497,047 S *	10/2004	Munns .....	D738,602 S	9/2015	Din	
D503,522 S *	4/2005	Schoenborn .....	D739,129 S	9/2015	Del Biondi	
6,957,504 B2	10/2005	Morris	D739,131 S	9/2015	Del Biondi	
D513,836 S	1/2006	Magro et al.	D739,132 S	9/2015	Del Biondi	
D530,893 S	10/2006	Sonnergren	D740,003 S	10/2015	Herath	
D540,517 S	4/2007	McClaskie	D740,004 S	10/2015	Hoellmueller et al.	
D549,937 S	9/2007	Matis et al.	D743,151 S *	11/2015	Toliver .....	D2/944
D550,431 S *	9/2007	Schoenborn .....	D743,152 S *	11/2015	Toliver .....	D2/944
D552,337 S *	10/2007	Parekh .....	D748,902 S	2/2016	Humphrey et al.	
D554,338 S	11/2007	Matis et al.	D754,956 S	5/2016	McCourt	
D556,989 S	12/2007	Horne et al.	D756,085 S *	5/2016	Spring .....	D2/947
D560,883 S	2/2008	McClaskie	D758,056 S	6/2016	Galway et al.	
D561,433 S	2/2008	McClaskie	D759,358 S	6/2016	Cullen	
D561,441 S	2/2008	Matis et al.	D762,958 S	8/2016	Bars	
D564,190 S	3/2008	Belley et al.	D764,786 S	8/2016	Nascimento	
D566,938 S *	4/2008	Matis .....	D765,362 S	9/2016	Kuerbis	
D566,939 S	4/2008	Schoenborn et al.	D765,961 S	9/2016	McClaskie	
D566,940 S	4/2008	Schoenborn et al.	D767,862 S	10/2016	Hurayt	
D572,447 S	7/2008	Schoenborn et al.	D773,790 S	12/2016	Raysse	
D574,581 S	8/2008	Cooper	D773,791 S	12/2016	Raysse	
D576,780 S	9/2008	Jolicoeur	D776,410 S	1/2017	Galway et al.	
D578,282 S	10/2008	Duffy	D777,412 S *	1/2017	Antonelli .....	D2/951
D578,743 S	10/2008	Liow	D781,543 S	3/2017	Raysse	
			9,591,891 B1	3/2017	Baucom et al.	
			D782,799 S	4/2017	Caron et al.	
			9,610,746 B2	4/2017	Wardlaw et al.	



(56)

References Cited

U.S. PATENT DOCUMENTS

D788,422 S 6/2017 Gibson  
 D792,067 S 7/2017 Raysse  
 D794,289 S 8/2017 Kanata  
 D796,170 S 9/2017 Raysse  
 D796,803 S 9/2017 Nethongkome  
 D799,180 S 10/2017 Sokol  
 D799,183 S 10/2017 Weeks  
 D801,011 S 10/2017 Del Biondi et al.  
 D802,261 S 11/2017 Stillwagon  
 D802,899 S 11/2017 Bischoff et al.  
 9,849,645 B2 12/2017 Wardlaw et al.  
 D809,258 S \* 2/2018 McGhee ..... D2/960  
 D809,755 S 2/2018 Stavseng et al.  
 D809,756 S 2/2018 Stavseng et al.  
 D810,408 S 2/2018 Hernandez  
 D811,062 S 2/2018 Teague  
 D812,878 S 3/2018 Nethongkome  
 D814,155 S 4/2018 Hernandez  
 D814,758 S 4/2018 Truelsen  
 9,961,961 B2 5/2018 Smith  
 D819,307 S 6/2018 Wurtz  
 D819,310 S 6/2018 Lashmore  
 D819,317 S 6/2018 Wurtz  
 D820,568 S 6/2018 Bray, Jr.  
 D828,686 S 9/2018 Hoellmueller et al.  
 D834,291 S 11/2018 Chang  
 10,149,512 B1 12/2018 Wurtz  
 D836,892 S 1/2019 Jenkins et al.  
 D838,092 S 1/2019 Bacon  
 D838,957 S 1/2019 Robusti  
 D839,573 S \* 2/2019 Small ..... D2/957  
 D839,576 S \* 2/2019 Small ..... D2/960  
 D840,136 S 2/2019 Herath et al.  
 D840,137 S 2/2019 Herath et al.  
 D841,955 S \* 3/2019 Winfield ..... D2/953  
 D841,965 S \* 3/2019 Goldman ..... D2/960  
 D842,594 S \* 3/2019 Small ..... D2/953  
 D846,255 S 4/2019 Khalife  
 10,258,104 B2 4/2019 Kraft  
 D848,715 S 5/2019 Holmes  
 D848,721 S \* 5/2019 Fracassi ..... D2/958  
 D849,382 S 5/2019 Jenkins et al.  
 D850,083 S \* 6/2019 Jenkins ..... D2/959  
 D850,766 S 6/2019 Girard et al.  
 D852,475 S 7/2019 Hoellmueller  
 D852,476 S 7/2019 Hartmann  
 D853,099 S 7/2019 Parrett  
 D853,690 S 7/2019 Taylor  
 D853,691 S 7/2019 Coonrod et al.  
 D853,699 S 7/2019 Coonrod et al.  
 D854,288 S 7/2019 Raasch  
 D855,295 S 8/2019 Della Valle et al.  
 D855,297 S 8/2019 Motoki  
 D855,953 S 8/2019 Girard et al.  
 D855,959 S \* 8/2019 Jenkins ..... D2/959  
 D855,960 S \* 8/2019 Gibson ..... D2/959  
 D858,051 S 9/2019 Mace  
 D858,059 S 9/2019 McMillan  
 D858,960 S 9/2019 Mace  
 D858,961 S 9/2019 Mace  
 D859,797 S \* 9/2019 Chanthavong ..... D2/947  
 D859,801 S \* 9/2019 Jenkins ..... D2/959  
 D861,311 S \* 10/2019 Hatfield ..... D2/959  
 D862,051 S 10/2019 Goussev et al.  
 D862,053 S 10/2019 de Montgolfier  
 D864,539 S \* 10/2019 Fuerst, Sr. .... D2/957  
 D866,137 S 11/2019 Kanata  
 D866,141 S \* 11/2019 Seamarks ..... D2/953  
 D867,734 S 11/2019 Dieudonne  
 D867,737 S 11/2019 Kanata  
 D868,440 S 12/2019 Dieudonne  
 D869,833 S 12/2019 Hartmann et al.  
 D870,433 S 12/2019 Hartmann et al.  
 10,506,846 B2 12/2019 Wardlaw et al.  
 D873,545 S 1/2020 Hartmann et al.

D874,099 S 2/2020 Hartmann et al.  
 D874,107 S 2/2020 Girard et al.  
 D874,801 S 2/2020 Hartmann et al.  
 D875,358 S 2/2020 Vella  
 D875,360 S 2/2020 Vella  
 D875,361 S 2/2020 Girard et al.  
 D875,362 S 2/2020 Girard et al.  
 D875,383 S 2/2020 Mace  
 D876,055 S 2/2020 Hartmann et al.  
 D876,064 S \* 2/2020 Shyllon ..... D2/957  
 D876,069 S 2/2020 Mace  
 D876,757 S 3/2020 Hartmann et al.  
 D876,791 S 3/2020 Gridley  
 D877,465 S 3/2020 Hartmann et al.  
 D877,466 S 3/2020 Hartmann et al.  
 D877,468 S 3/2020 Reyes  
 D878,015 S 3/2020 Hartmann et al.  
 D878,021 S 3/2020 Mace  
 D878,025 S 3/2020 Hartmann et al.  
 2003/0046831 A1 3/2003 Westin  
 2003/0208925 A1 11/2003 Pan  
 2004/0148805 A1 8/2004 Morris  
 2005/0022424 A1 2/2005 Held  
 2006/0026863 A1 2/2006 Liu  
 2006/0175036 A1 8/2006 Guerrero  
 2007/0119076 A1 5/2007 Brewer et al.  
 2008/0250666 A1 10/2008 Votolato  
 2009/0025260 A1 1/2009 Nakano  
 2009/0100721 A1 4/2009 Gorynski  
 2010/0242309 A1 9/2010 McCann  
 2011/0099845 A1 5/2011 Miller  
 2011/0283560 A1 11/2011 Portzline et al.  
 2012/0180343 A1 7/2012 Auger et al.  
 2013/0145653 A1 6/2013 Bradford  
 2013/0291409 A1 11/2013 Reinhardt et al.  
 2014/0151918 A1 6/2014 Hartmann  
 2014/0223776 A1 8/2014 Wardlaw et al.  
 2014/0373392 A1 12/2014 Cullen  
 2015/0047222 A1 2/2015 Rushbrook  
 2016/0007676 A1 1/2016 Leimer et al.  
 2016/0037859 A1 2/2016 Smith et al.  
 2016/0051009 A1 2/2016 Kormann et al.  
 2016/0278481 A1 9/2016 Le et al.  
 2016/0295955 A1 10/2016 Wardlaw et al.  
 2017/0006958 A1 1/2017 Jeong  
 2017/0224053 A1 8/2017 Truelsen et al.  
 2017/0253710 A1 9/2017 Smith et al.  
 2018/0077997 A1 3/2018 Hoffer et al.  
 2018/0103719 A1 4/2018 Chen  
 2018/0153264 A1 6/2018 Amos et al.  
 2018/0154598 A1 6/2018 Kurtz et al.  
 2018/0192738 A1 7/2018 Amos et al.  
 2018/0199667 A1 7/2018 Wang  
 2018/0206590 A1 7/2018 Amos et al.  
 2018/0303197 A1 10/2018 Chen et al.  
 2018/0317591 A1 11/2018 Hollinger et al.  
 2018/0345576 A1 12/2018 Constantinou et al.  
 2019/0297995 A1 10/2019 Loveder et al.

OTHER PUBLICATIONS

Ignite Flash evoKNIT Men's Training Shoes, Puma.com, [online], [site visited Mar. 24, 2020]. <URL: [https://us.puma.com/en/us/pd/ignite-flash-evoknit-mens-training-shoes/190508.html?dwvar\\_190508\\_color=28](https://us.puma.com/en/us/pd/ignite-flash-evoknit-mens-training-shoes/190508.html?dwvar_190508_color=28)> (Year: 2020).\*

Hybrid Fuego Men's Running Shoes, Puma.com, [online], [site visited Mar. 24, 2020]. <URL: [https://us.puma.com/en/us/pd/hybrid-fuego-mens-running-shoes/192661.html?dwvar\\_192661\\_color=10](https://us.puma.com/en/us/pd/hybrid-fuego-mens-running-shoes/192661.html?dwvar_192661_color=10)> (Year: 2020).\*

Puma Men's Hybrid Fuego Sneaker, Amazon.com, Date first listed on Amazon: May 16, 2019, [online], [site visited Mar. 24, 2020]. <URL: <https://www.amazon.com/PUMA-Mens-Hybrid-Fuego-Sneaker/dp/B07KRVL6S8?th=1>> (Year: 2019).\*

Adidas Parleyu posted by Dan Howarth posted date Jun. 8, 2016, © DEZEEN, [online], [site visited Jun. 23, 2019]. Available from Internet, <https://www.dezeen.com/2016/06/08/adidas-trainers-parley-for-the-ocean-plastic-design-recycling/> (Year: 2016).



(56)

## References Cited

## OTHER PUBLICATIONS

Axelion Sneaker posted by PU MA posted date Sep. 21, 2015, © Amazon, [online], [site visited Aug. 26, 2019]. Available from Internet, <https://www.amazon.com/PUMA-Axelion-Sneaker-Black-White> (Year: 2015).

Hybrid Astro Men's Running Shoes, Puma.com, [online], [site visited Nov. 21, 2019]. <URL: [https://us.puma.com/en/us/pd/hybrid-astro-mens-running-shoes/192799.html?dwvar\\_192799\\_color=06](https://us.puma.com/en/us/pd/hybrid-astro-mens-running-shoes/192799.html?dwvar_192799_color=06)> (Year: 2019).

Hybrid NX Rave Men's Running Shoes, Puma.com, [online], [site visited Nov. 21, 2019]. <URL: [https://us.puma.com/en/us/pd/hybrid-nx-rave-mens-running-shoes/192589.html?dwvar\\_192589\\_color=01](https://us.puma.com/en/us/pd/hybrid-nx-rave-mens-running-shoes/192589.html?dwvar_192589_color=01)> (Year: 2019).

Hybrid Rocket posted by PUMA posted date Aug. 9, 2018, © Amazon UK, [online], [site visited Jun. 23, 2019]. Available from Internet, <https://www.amazon.co.uk/Puma-Hybrid-Rocket-Competition-Running/dp> (Year: 2018).

Hybrid Runner posted by PUMA posted date Sep. 21, 2015, © Amazon, [online], [site visited Aug. 26, 2019]. Available from Internet, [https://www.amazon.com/PUMA-Mens-Hybrid-Runner-Sneaker/dp/B0784VD6W7/ref=pd\\_sbs\\_309\\_5/137-0173175-0769536?encoding=UTF8&pd\\_rd\\_i=B0784VD6W7&pd\\_rd\\_r=be13506c-96a2-4b93-99d7-8cb69349032](https://www.amazon.com/PUMA-Mens-Hybrid-Runner-Sneaker/dp/B0784VD6W7/ref=pd_sbs_309_5/137-0173175-0769536?encoding=UTF8&pd_rd_i=B0784VD6W7&pd_rd_r=be13506c-96a2-4b93-99d7-8cb69349032).

Hybrid Running Sneaker posted by PUMA posted date Aug. 9, 2018, © Amazon, [online], [site visited Aug. 1, 2019]. Available from Internet, <https://www.amazon.com/PUMA-Hybrid-Runner-Sneaker-Peacoat-Blazing> (Year: 2018).

Introducing the Puma Jamming Cushion posted by Mario Briguglio posted date Nov. 7, 2017, © Sneaker Bar Detroit, [online], [site visited Aug. 26, 2019]. Available from Internet, <https://sneakerbardetroit.com/puma-jamming-cushion-forest-night/> (Year: 2017).

Nike Flexmethod TR, Nike.com, [online], [site visited Nov. 21, 2019]. <URL: <https://www.nike.com/t/flexmethod-tr-mens-training-shoe-Shs7r6/BQ3063-005>> (Year: 2019).

Nike Force Zoom Trout 6 turf Premium, Nike.com, [online], [site visited Nov. 21, 2019]. <URL: <https://www.nike.com/t/force-zoom-trout-6-turf-premium-mens-baseball-shoe-cF8xd0/AT3881-400>> (Year: 2019).

Nike Joyride Dual Run, Nike.com, [online], [site visited Nov. 21, 2019]. <URL: <https://www.nike.com/t/joyride-dual-run-mens-running-shoe-8BGXtk/CD4365-003>> (Year 2019).

Prophere posted by Adidas posted date Aug. 2, 2012, © Amazon, [online], [site visited Aug. 12, 2019]. Available from Internet, [https://www.amazon.com/dp/B07K3CFRDX/ref=nav\\_timeline\\_asin?encoding=UTF8&pvc=1](https://www.amazon.com/dp/B07K3CFRDX/ref=nav_timeline_asin?encoding=UTF8&pvc=1) (Year: 2012).

PUMA Hybrid posted by Eli Yeh posted date Jul. 6, 2018, © YouTube, [online], [site visited Aug. 15, 2019]. Available from Internet, <https://www.youtube.com/watch?v=HdOEndfYBtO> (Year 2018).

Puma Hybrid Rocket posted by Puma posted date Sep. 21, 2015, © Amazon, [online], [site visited Aug. 26, 2019]. Available from Internet, <https://www.amazon.com/PUMA-Hybrid-Rocket-Runner-Sneaker> (Year: 2015).

Nike Air Zoom Wildhorse 5, Nike.com, [online], [site visited Nov. 21, 2019]. <URL: <https://www.nike.com/t/air-zoom-wildhorse-5-mens-trail-running-shoe-IMsIPS/AQ2222-200>> (Year: 2019).

KD Trey 5 VII, Nike.com, [online], [site visited Nov. 21, 2019]. <URL: <https://www.nike.com/t/kd-trey-5-vii-shoe-1pM0S4/AT1200-002>> (Year: 2019).

This Puma Shoe looks like a Funhouse but packs a Propulsive Punch, RunnersWorld.com, by Amanda Furrer, Aug. 19, 2019, [online], [site visited Nov. 21, 2019]. <URL: <https://www.runnersworld.com/gear/a28746944/puma-speed-orbitor-review/>> (Year: 2019).

Hi Octn Sports Design Men's Motorsport Shoes, Puma.com, [online], [site visited Mar. 24, 2020]. <URL: [https://us.puma.com/en/us/pd/hi-octn-sports-design-mens-motorsport-shoes/372106.html?dwvar\\_372106\\_color=02](https://us.puma.com/en/us/pd/hi-octn-sports-design-mens-motorsport-shoes/372106.html?dwvar_372106_color=02)> (Year: 2020), 1 page.

Hybrid Astro Men's Running Shoes, Puma.com, [online], [site visited Mar. 24, 2020]. <URL: [https://us.puma.com/en/us/pd/hybrid-astro-mens-running-shoes/192799.html?dwvar192799\\_color=08](https://us.puma.com/en/us/pd/hybrid-astro-mens-running-shoes/192799.html?dwvar192799_color=08)> (Year: 2020), 1 page.

Porsche Design Hybrid Runner II Men's Running Shoes, Puma.com, [online], [site visited Mar. 24, 2020]. <URL: [https://us.puma.com/en/us/pd/porsche-design-hybrid-runner-ii-mens-running-shoes/339956.html?dwvar\\_339956\\_color=02](https://us.puma.com/en/us/pd/porsche-design-hybrid-runner-ii-mens-running-shoes/339956.html?dwvar_339956_color=02)> (Year: 2020), 1 page.

Speed Orbiter Men's Running Shoes, Puma.com, [online], [site visited Mar. 24, 2020]. <URL: [https://us.puma.com/en/us/pd/speed-orbiter-mens-running-shoes/192571.html?dwvar192571\\_color=04](https://us.puma.com/en/us/pd/speed-orbiter-mens-running-shoes/192571.html?dwvar192571_color=04)> (Year: 2020), 1 page.

PUMA Men's Hybrid Astro Sneaker, Amazon.com, Date first listed on Amazon: May 16, 2019, [online], [site visited Mar. 24, 2020]. <URL: <https://www.amazon.com/Puma-Mens-Hybrid-Astro-Sneaker/dp/B07TNXFVBV?th=1>> (Year: 2019), 3 pages.

SNEAKERSER midsole painting—Nike Air max 1 'HOA' [Episode THREE], YouTube.com, SNEAKERS ER, Published on Aug. 23, 2016, [online], [site visited Mar. 24, 2020]. <URL: [https://www.youtube.com/watch?v=zGVcLdN\\_H9M](https://www.youtube.com/watch?v=zGVcLdN_H9M)> (Year: 2016), 1 page.

The Technologies That Define Sneaker Cushioning, Forbes.com, Nov. 5, 2018, 10:47am EST, Tim Newcomb, [online], [site visited Mar. 24, 2020]. <URL: <https://www.forbes.com/sites/timnewcomb/2018/11/05/the-technologies-that-define-sneaker-cushioning/#2c2e6da3356e>> (Year: 2018), 15 pages.

\* cited by examiner

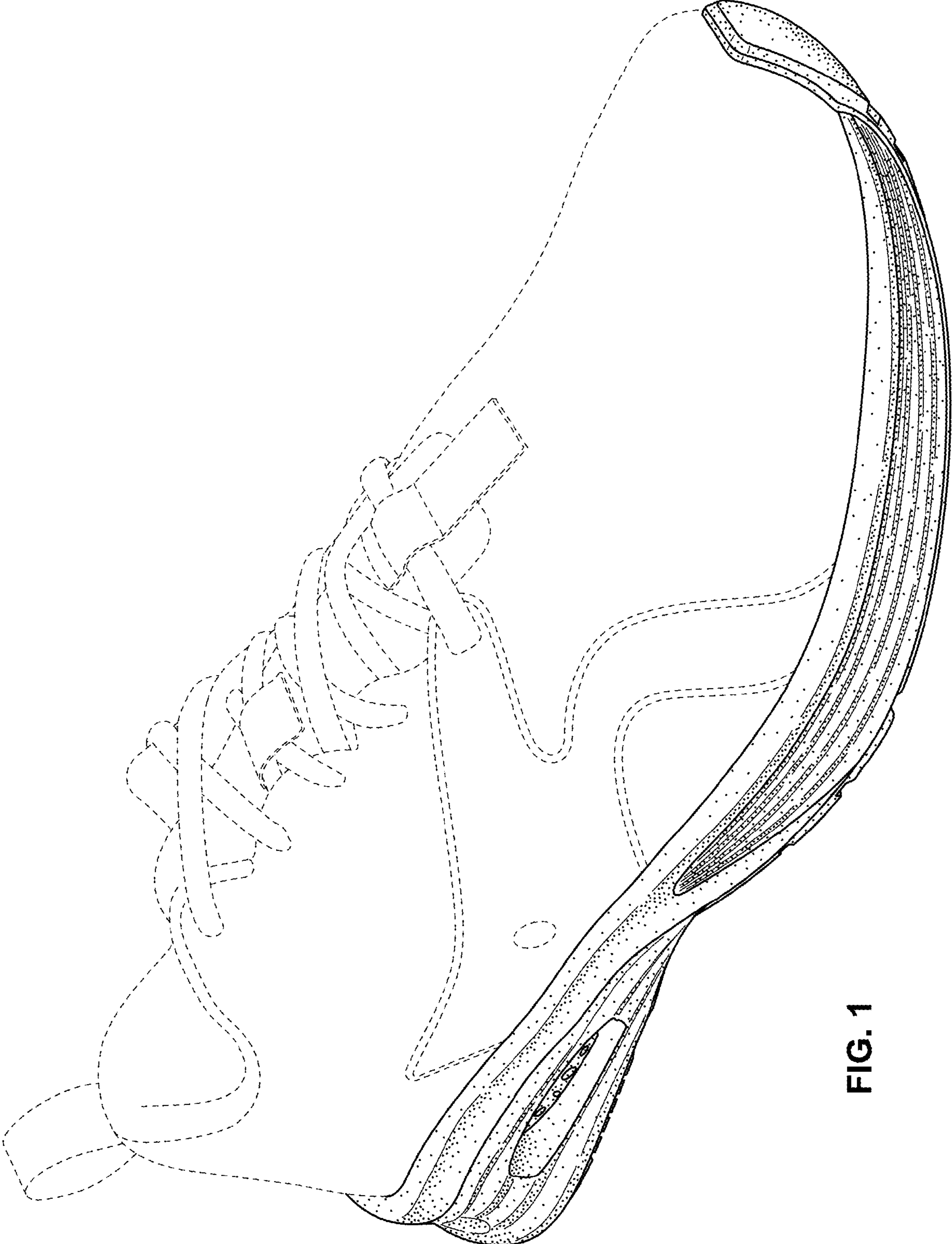

FIG. 1



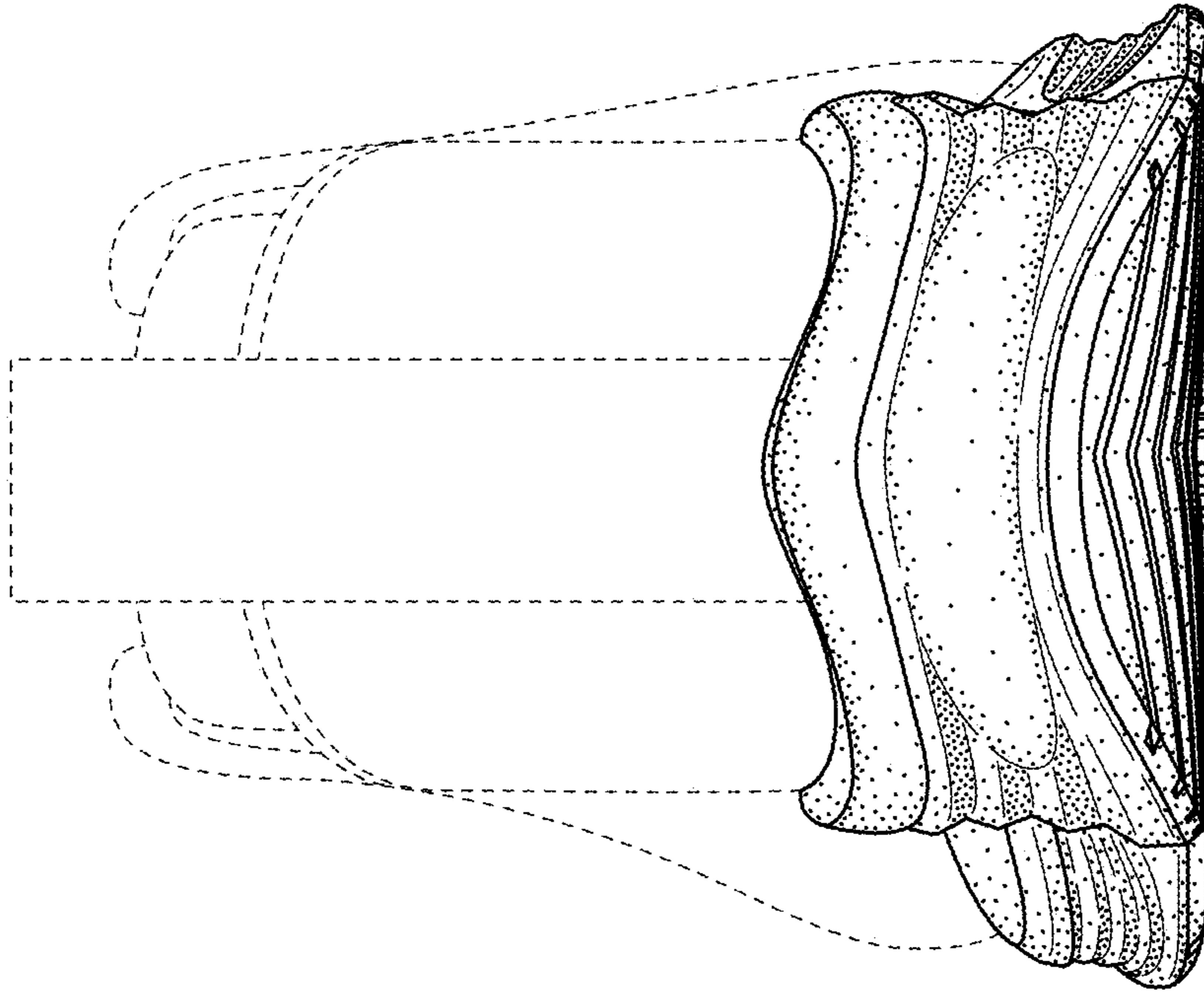

FIG. 3

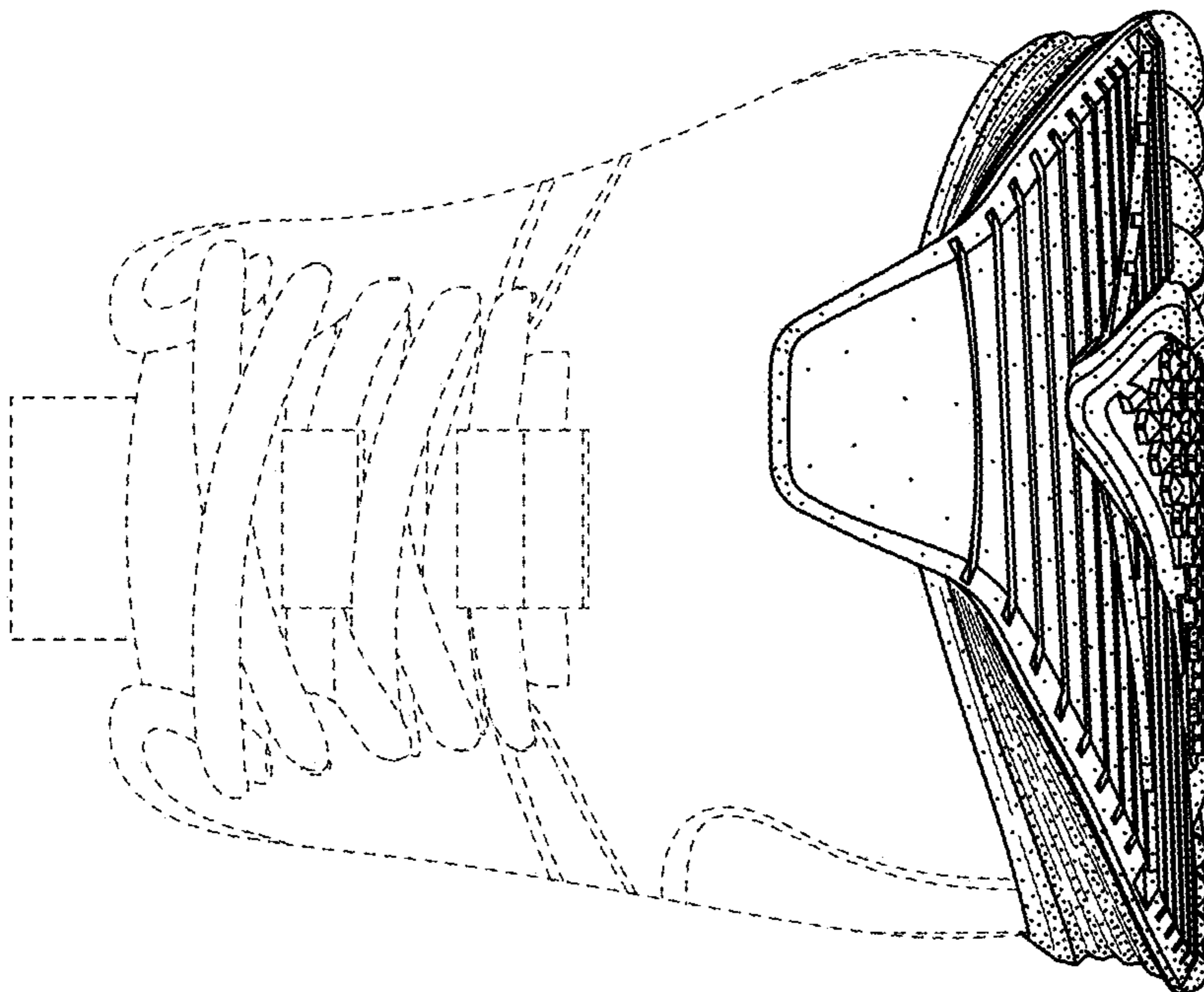

FIG. 2

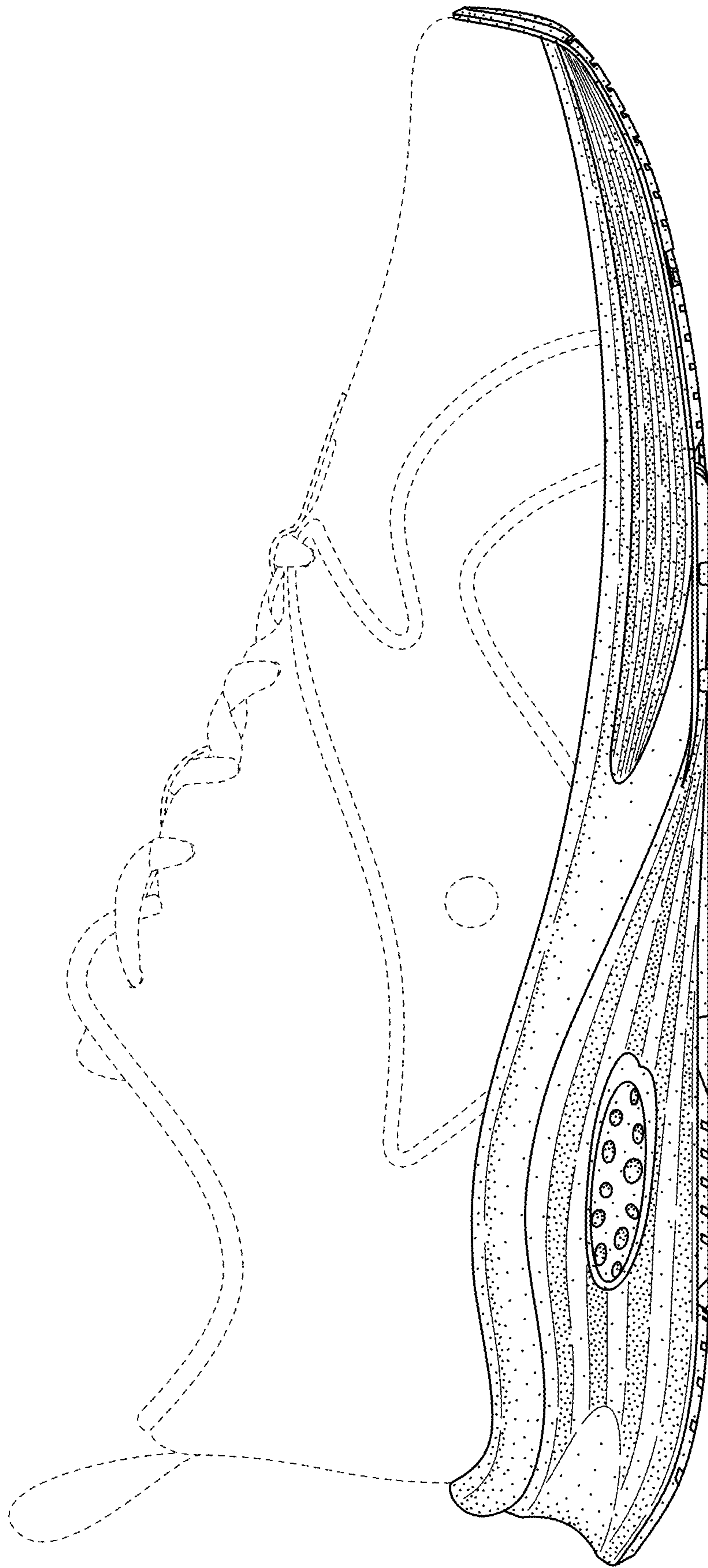

FIG. 4



FIG. 5



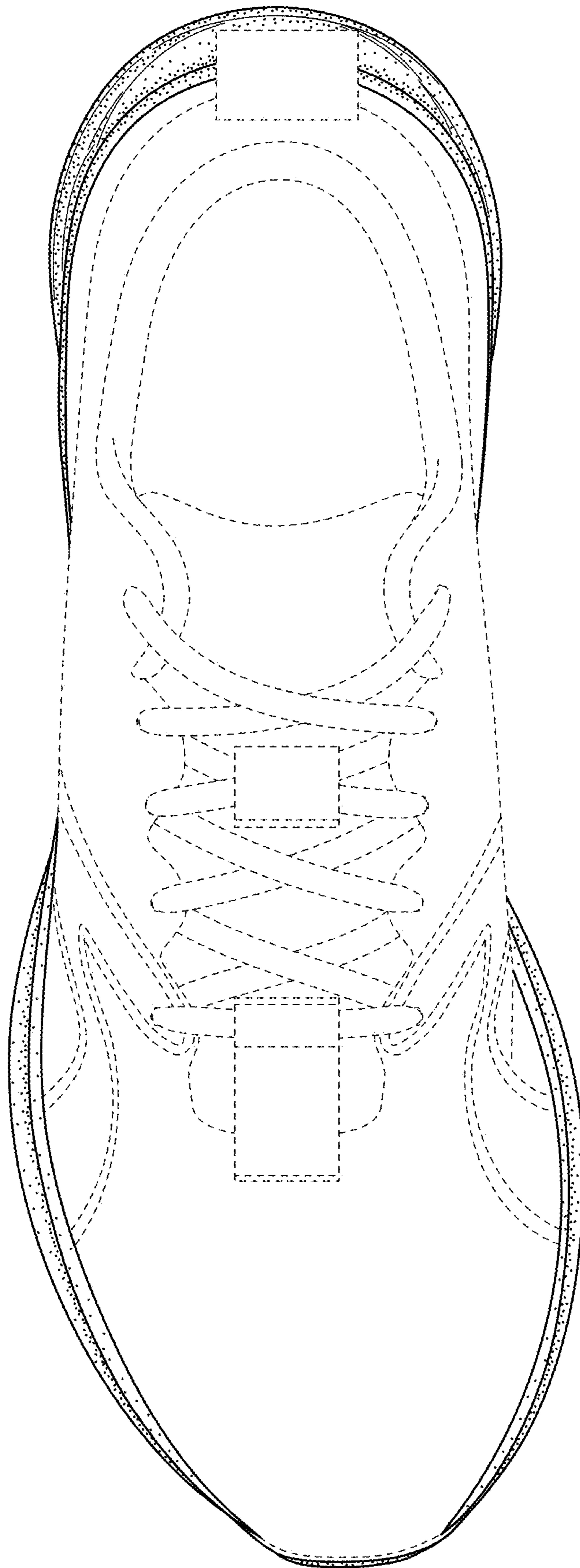

FIG. 6

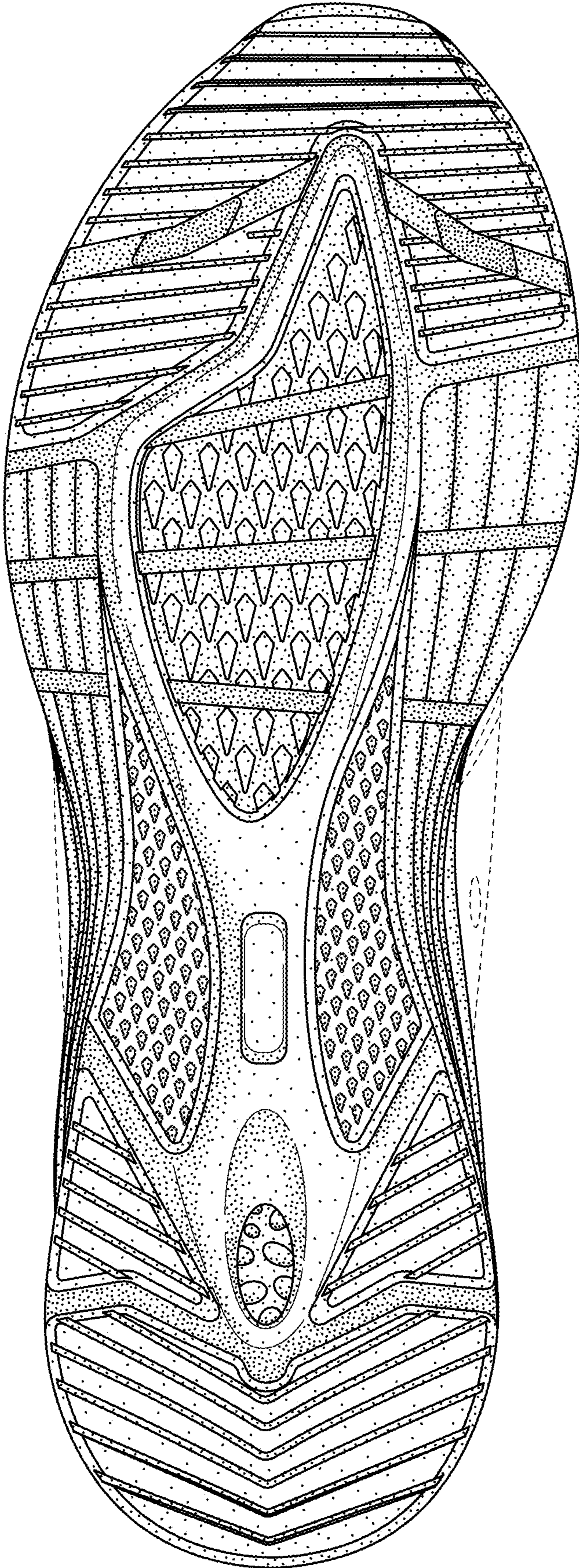

FIG. 7



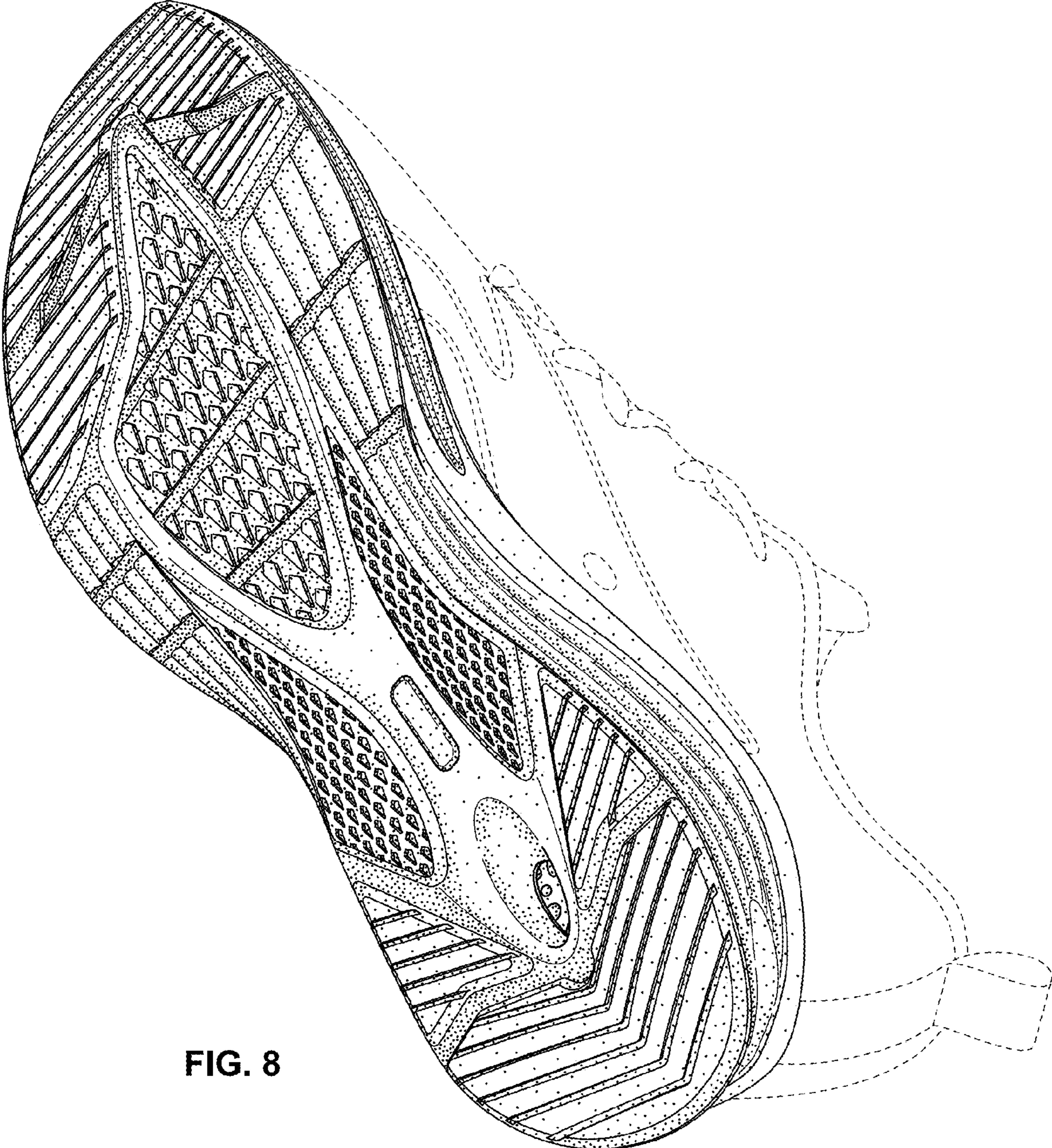

FIG. 8