



US00D889757S

(12) **United States Design Patent** (10) **Patent No.:** **US D889,757 S**
Anderson (45) **Date of Patent:** **** Jul. 7, 2020**

(54) **PET LITTER BOX FOR TRAVEL**
(71) Applicant: **Kara Anderson**, Brooklyn Park, MN (US)
(72) Inventor: **Kara Anderson**, Brooklyn Park, MN (US)
(**) Term: **15 Years**
(21) Appl. No.: **29/663,279**
(22) Filed: **Sep. 13, 2018**
(51) **LOC (12) Cl.** **30-99**
(52) **U.S. Cl.**
USPC **D30/161**
(58) **Field of Classification Search**
USPC D3/20, 200, 201, 203.1, 203.6, 205, 206, D3/272, 315, 319; D30/161, 162, 199
CPC A01K 1/0121; A01K 1/011; A01K 1/0117; A01K 1/0114; A01K 1/0125; A01K 1/0155; A01K 1/0154; A01K 29/00
See application file for complete search history.

(56) **References Cited**
U.S. PATENT DOCUMENTS
D218,446 S * 8/1970 Sleith D30/161
D617,959 S * 6/2010 Twu D30/161
D772,572 S * 11/2016 Palmberg D3/201
D779,813 S * 2/2017 Funk D3/205
D810,421 S * 2/2018 Ross D3/203.1
D839,583 S * 2/2019 Cao D3/201
D846,264 S * 4/2019 Wu D3/201

* cited by examiner

Primary Examiner — Michael C Stout
Assistant Examiner — Katrina N Gonzalez
(74) *Attorney, Agent, or Firm* — Winthrop & Weinstine, P.A.; Nadeem W. Schwen; Alicia Griffin Mills

(57) **CLAIM**
The ornamental design for a pet litter box for travel, as shown and described.

DESCRIPTION
FIG. 1 is an isometric view of the pet litter box for travel; FIG. 2 is a front view of the pet litter box for travel of FIG. 1; FIG. 3 is a rear view of the pet litter box for travel of FIG. 1; FIG. 4 is a right side view of the pet litter box for travel of FIG. 1; FIG. 5 is a left side view of the pet litter box for travel of FIG. 1; FIG. 6 is a top view of the pet litter box for travel of FIG. 1; FIG. 7 is a bottom view of the pet litter box for travel of FIG. 1; FIG. 8 is a top view of the pet litter box for travel of FIG. 1 in an open configuration; and, FIG. 9 is a perspective view of the pet litter box for travel of FIG. 1 in an open configuration. The broken lines illustrate portions of the pet litter box for travel that form no part of the claimed design.

1 Claim, 7 Drawing Sheets

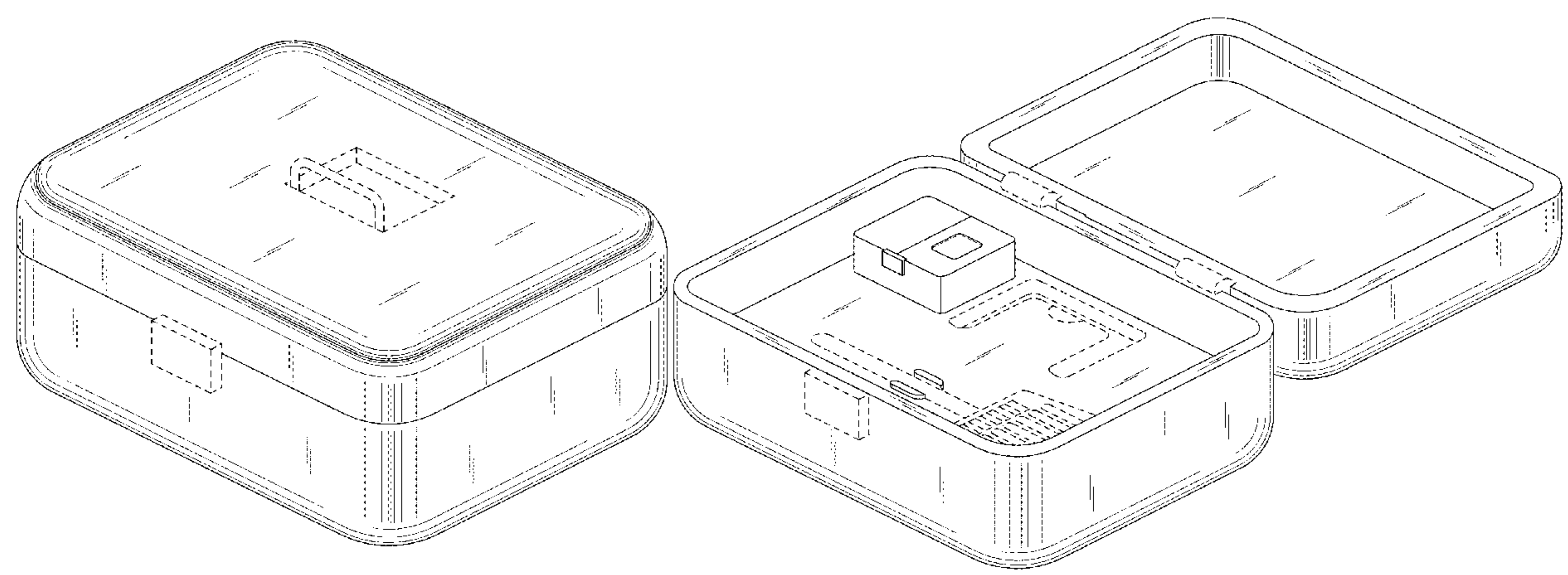

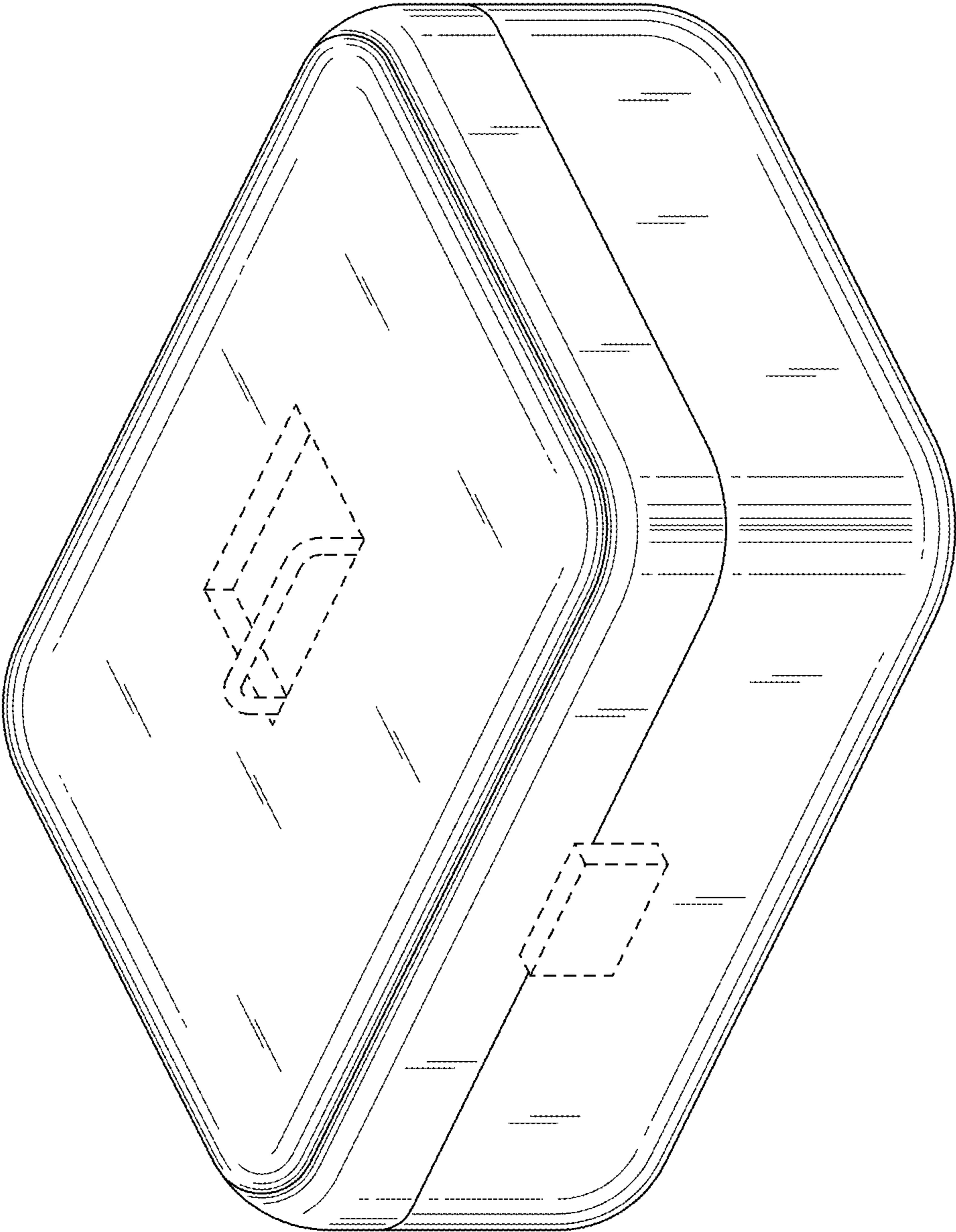

FIG. 1

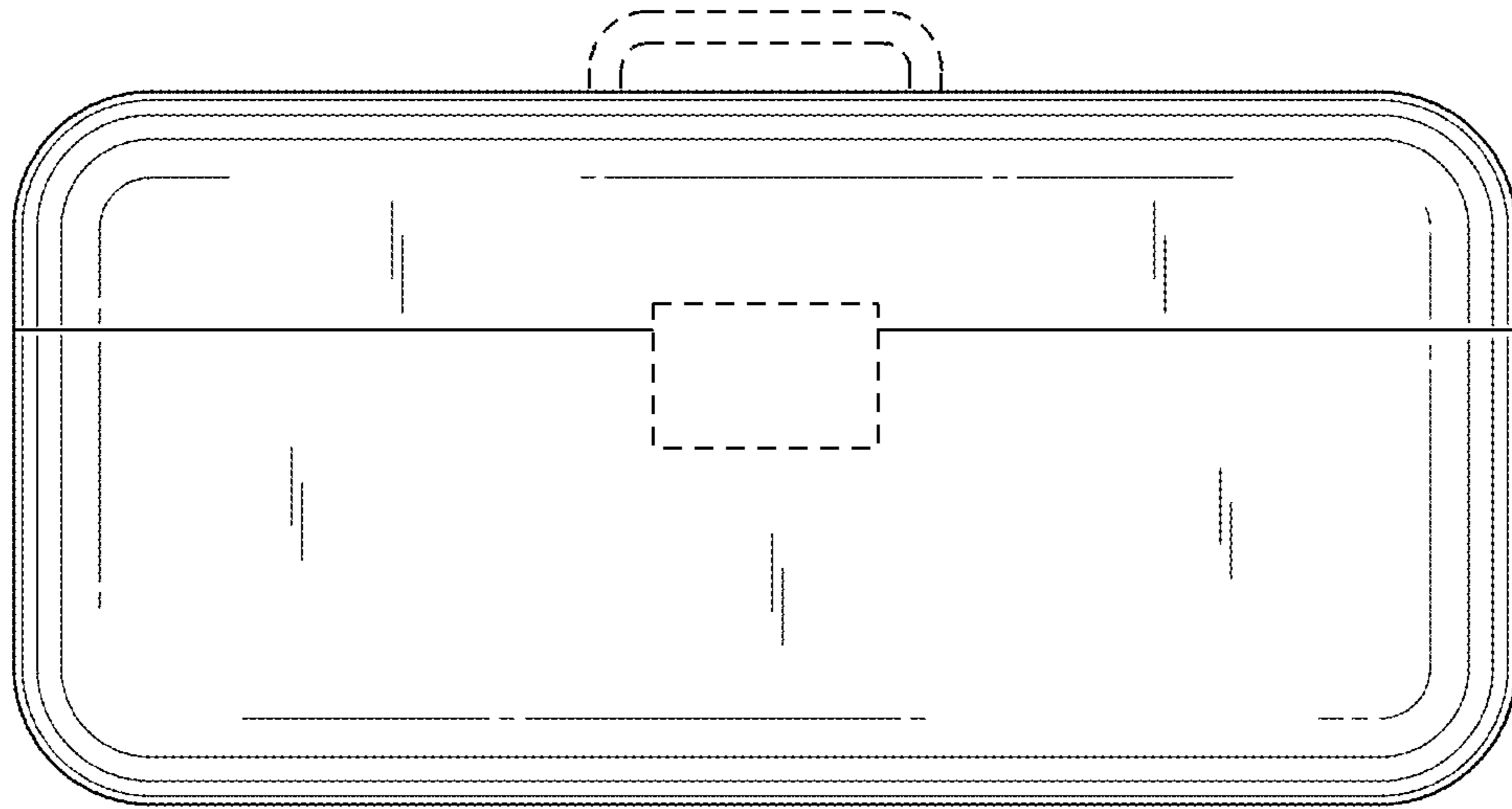

FIG. 2

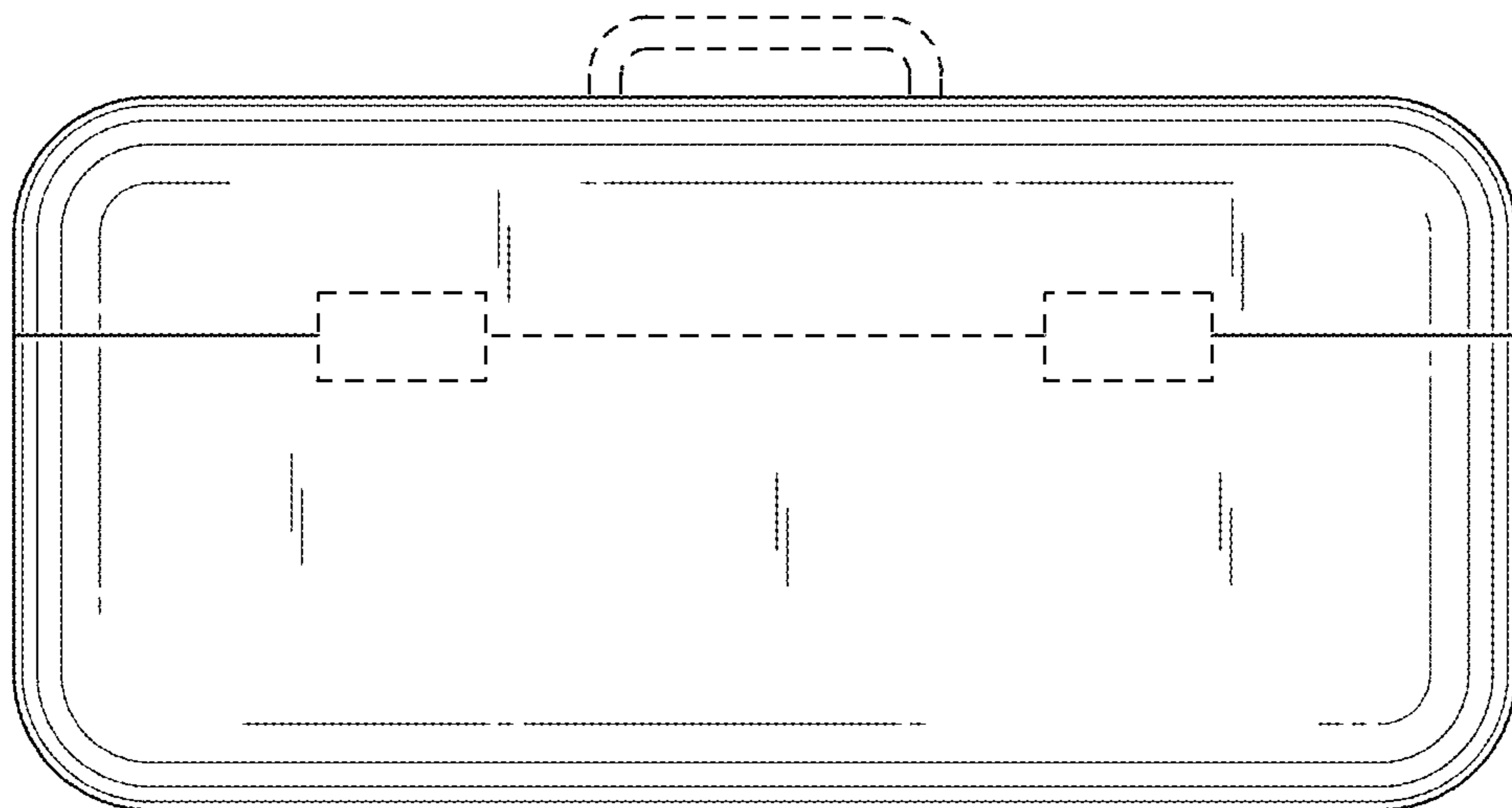

FIG. 3

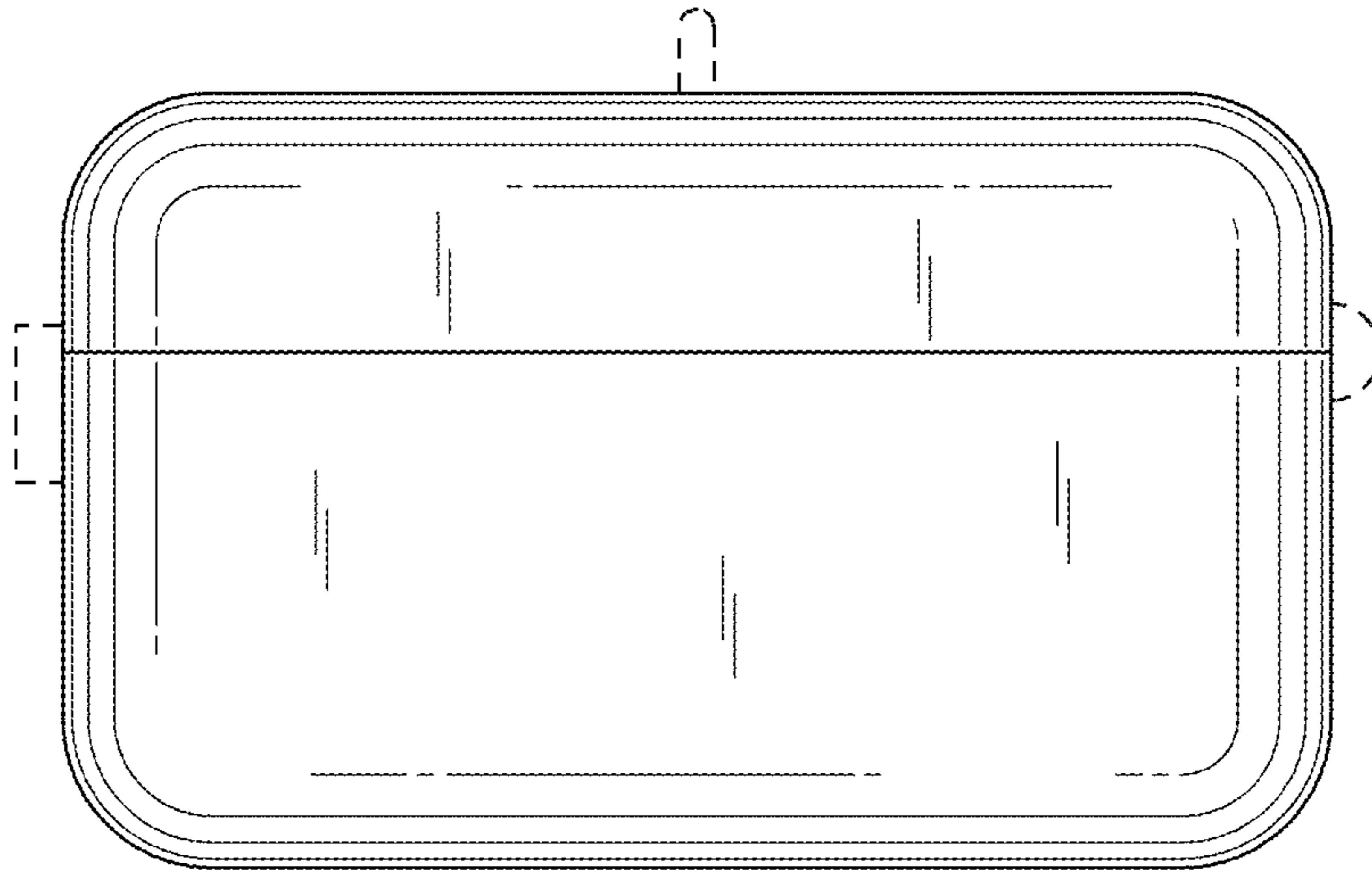

FIG. 4

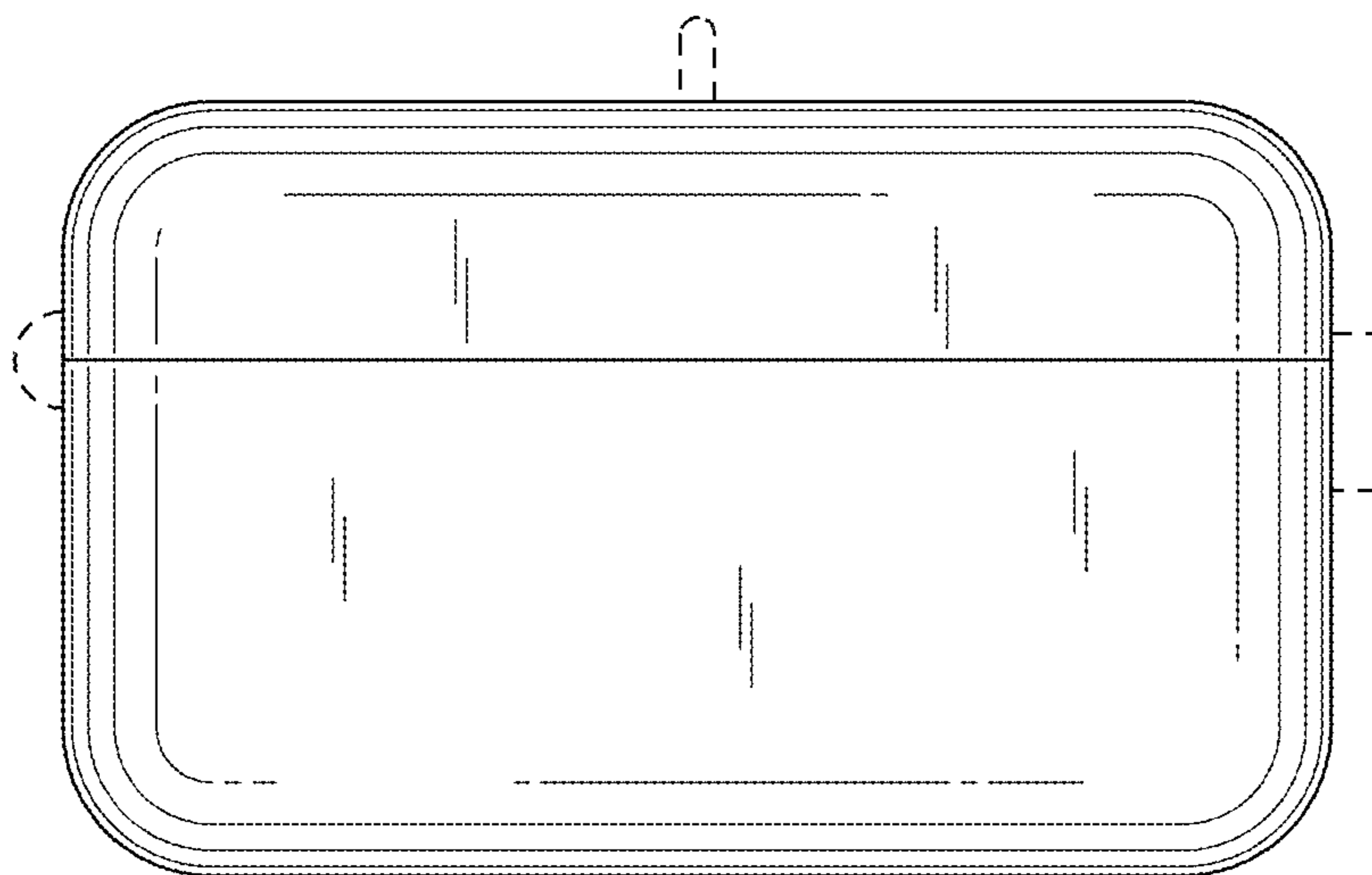

FIG. 5

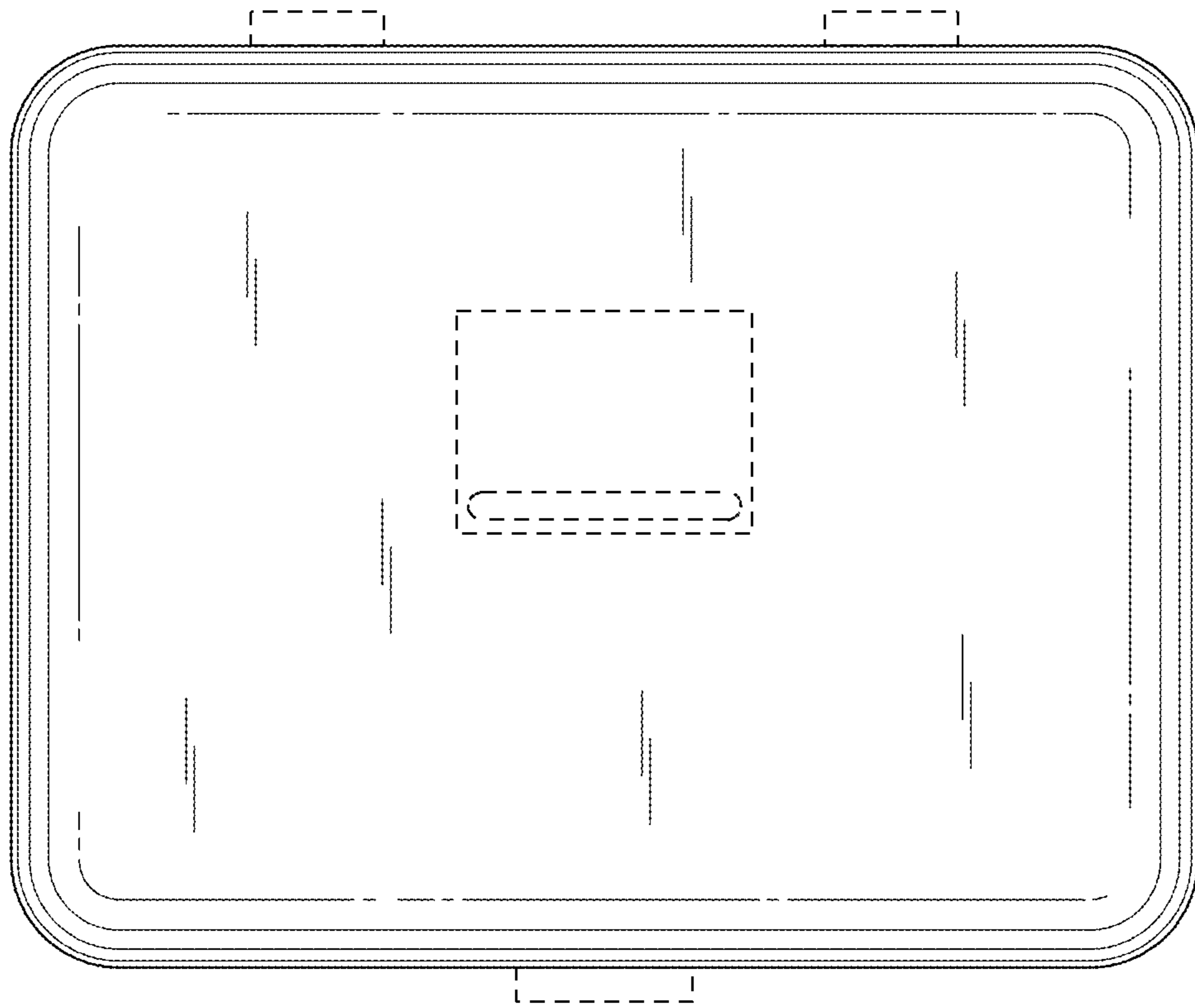

FIG. 6

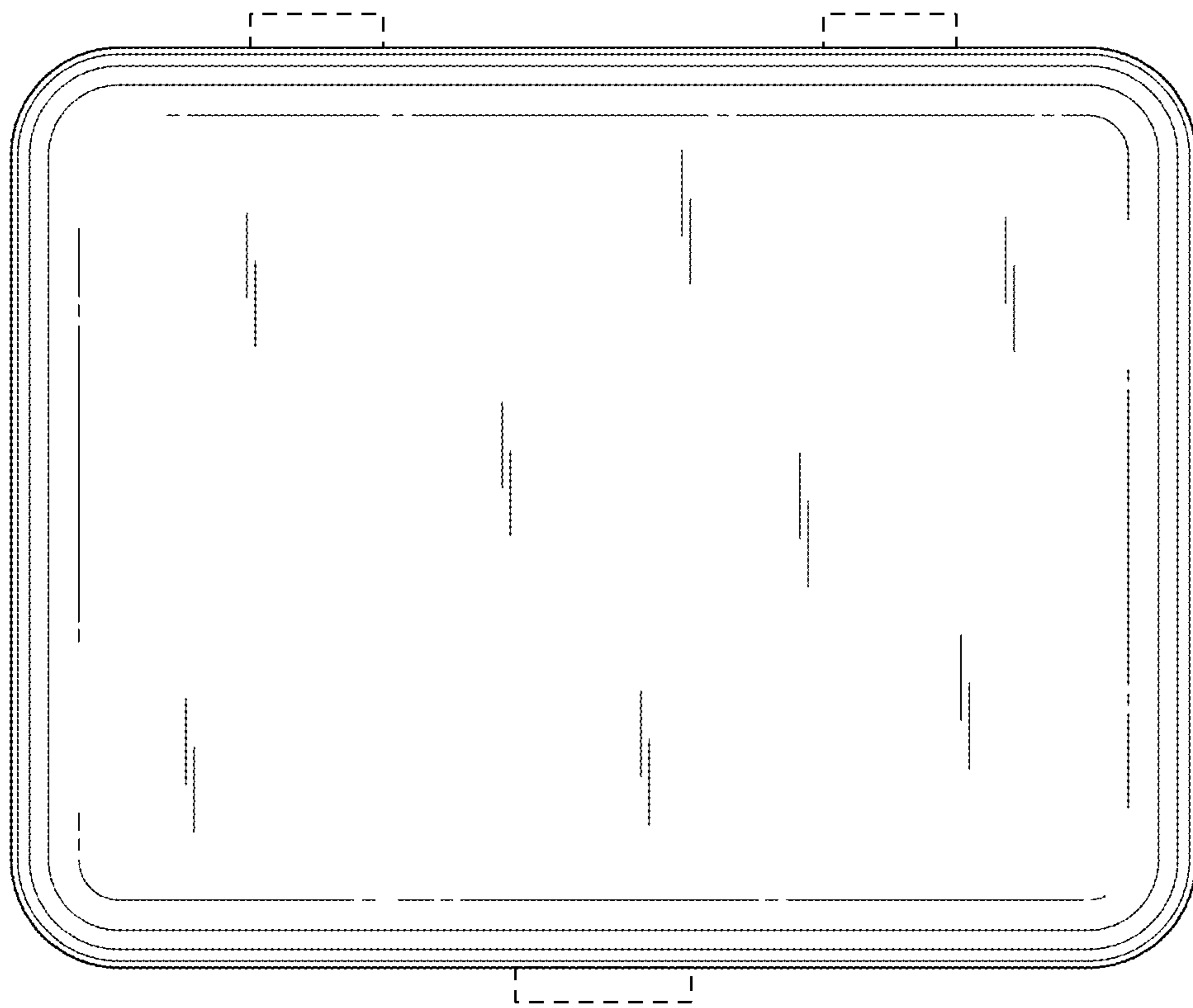

FIG. 7

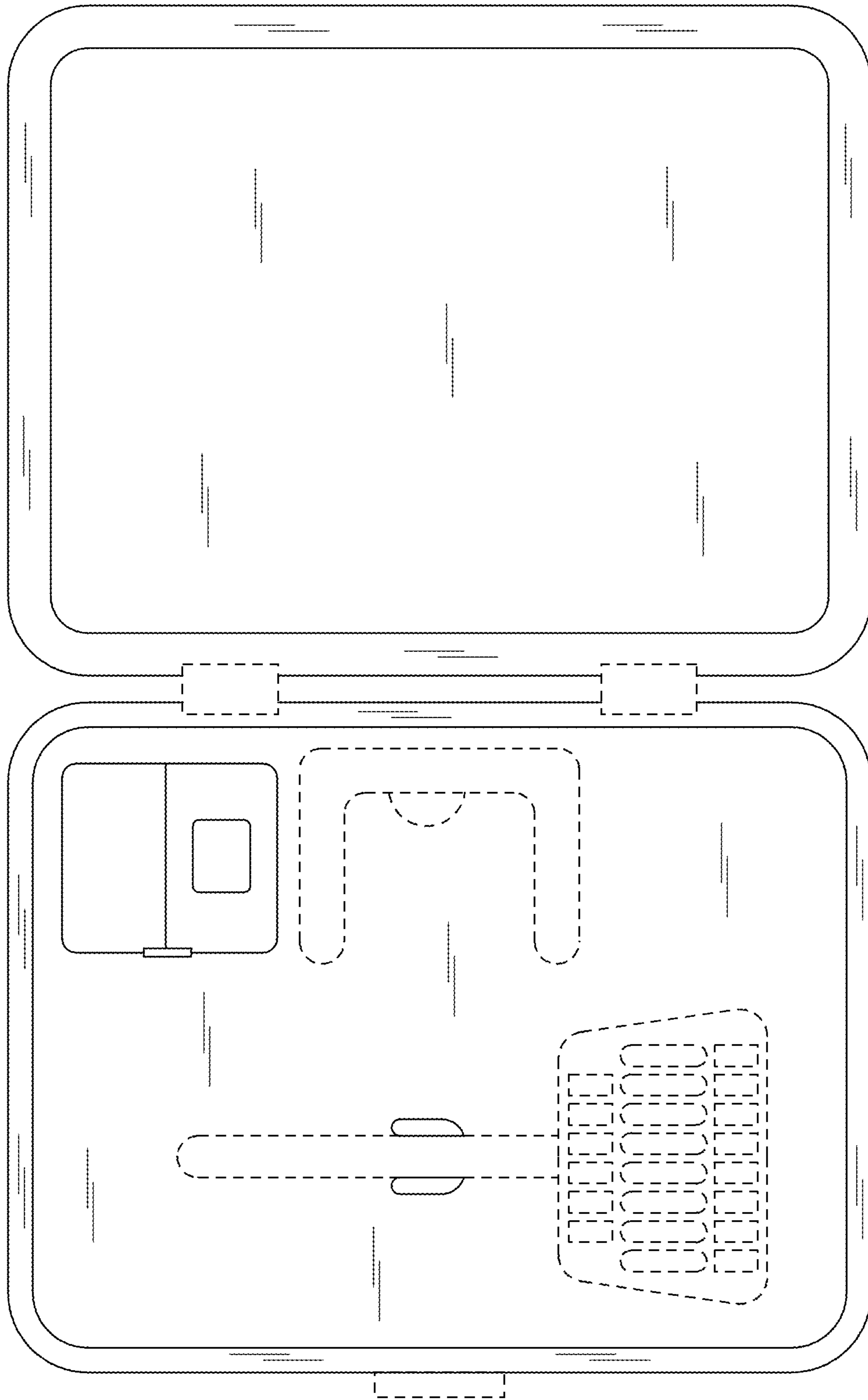

FIG. 8

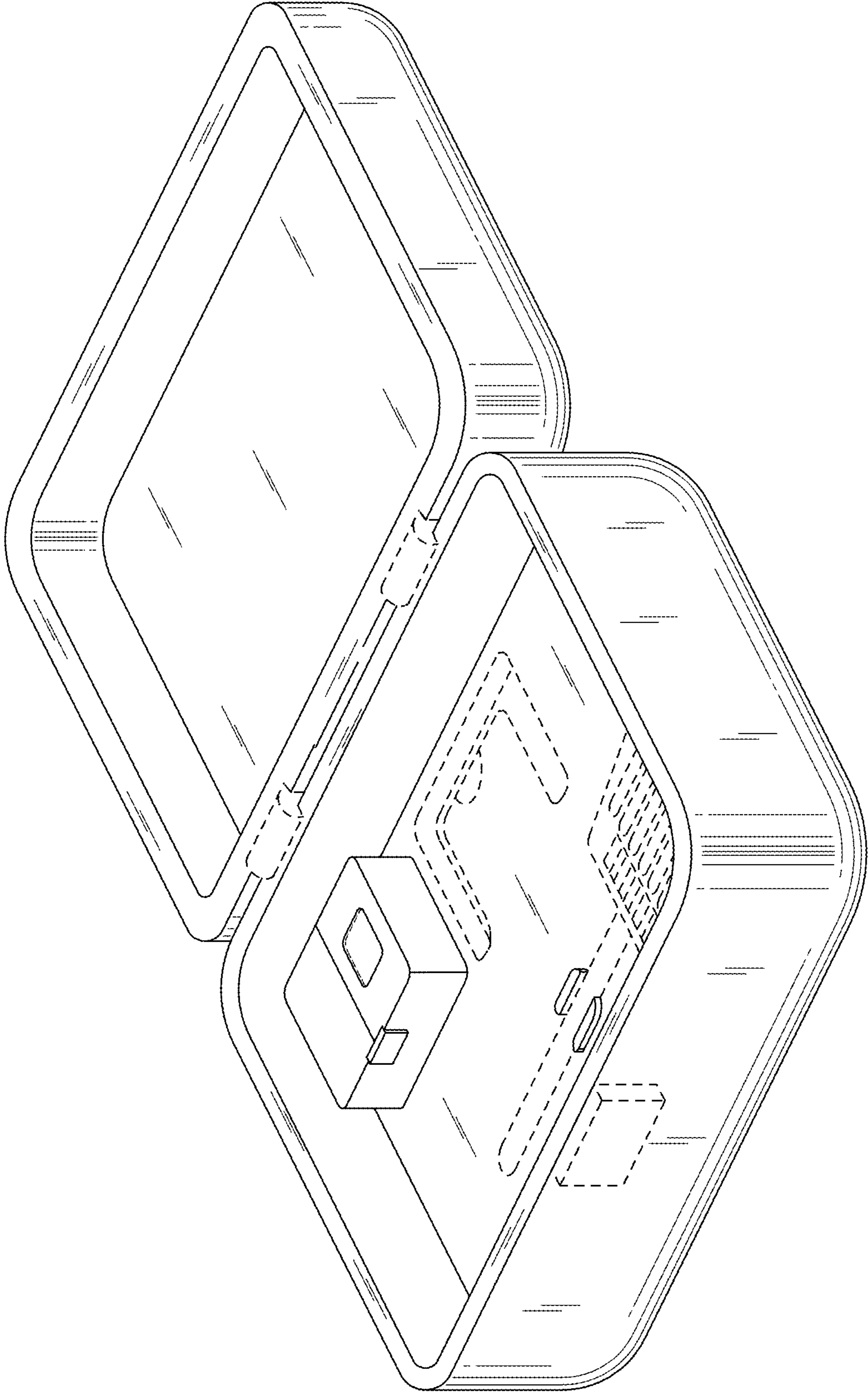

FIG. 9