



US00D889755S

(12) **United States Design Patent**  
**Dusev et al.**

(10) **Patent No.:** **US D889,755 S**  
(45) **Date of Patent:** **\*\* Jul. 7, 2020**

(54) **DOG HARNESS**

(71) Applicant: **Dogline, Inc.**, High Springs, FL (US)

(72) Inventors: **Vladislav Dusev**, High Springs, FL (US); **Vladimir Sklyarevsky**, High Springs, FL (US)

(73) Assignee: **Dogline, Inc.**, High Springs, FL (US)

(\*\*) Term: **15 Years**

(21) Appl. No.: **29/656,455**

(22) Filed: **Jul. 12, 2018**

(51) **LOC (12) Cl.** ..... **30-04**

(52) **U.S. Cl.**  
USPC ..... **D30/152**

(58) **Field of Classification Search**  
USPC ..... D30/144, 151–153, 199  
(Continued)

(56) **References Cited**

**U.S. PATENT DOCUMENTS**

1,614,083 A \* 1/1927 Plantico ..... A01K 27/002  
119/793  
5,794,571 A \* 8/1998 Goldberg ..... A01K 1/0263  
119/771

(Continued)

**OTHER PUBLICATIONS**

“Dogline—Quest Multi-Purpose Dog Harness.” Found online Feb. 26, 2020 at [www.doglinegroup.com](http://www.doglinegroup.com). Product reviewed Sep. 18, 2019. Retrieved from URL: <https://www.doglinegroup.com/collections/harnesses-and-vests/products/quest-multi-purpose-harness#shopify-product-reviews> (Year: 2019).\*

(Continued)

*Primary Examiner* — Mary Ann Calabrese  
*Assistant Examiner* — Katelin G Kloberg

(74) *Attorney, Agent, or Firm* — Kaplan Breyer Schwarz, LLP

(57) **CLAIM**

The ornamental design for a dog harness, as shown and described.

**DESCRIPTION**

FIG. 1 is a top, front, left side perspective view of a dog harness, showing our new design;  
FIG. 2 is a bottom, rear, left side perspective view of the dog harness depicted in FIG. 1;  
FIG. 3 is bottom, rear, left side perspective view of the dog harness depicted in FIG. 1;  
FIG. 4 is a bottom, front, left side perspective view of the dog harness depicted in FIG. 1;  
FIG. 5 is a rear elevation view of the dog harness depicted in FIG. 1;  
FIG. 6 is a front elevation view of the dog harness depicted in FIG. 1;  
FIG. 7 is a left side elevation view of the dog harness depicted in FIG. 1;  
FIG. 8 is a right side elevation view of the dog harness depicted in FIG. 1;  
FIG. 9 is a top plan view of the dog harness depicted in FIG. 1;  
FIG. 10 is a bottom plan view of the dog harness depicted in FIG. 1;  
FIG. 11 is a top, front, left side perspective view of the dog harness, shown within an environment of use;  
FIG. 12 is a top, rear, left side perspective view thereof; and, FIG. 13 is a top, front, left side perspective view of the dog harness depicted in FIG. 1, shown in an alternate condition of use.

The broken lines shown on the surface of the dog harness depict portions of the article that form no part of the claimed design. In FIGS. 11 and 12, the broken lines depicting a dog represent environmental subject matter that forms no part of the claimed design.

**1 Claim, 12 Drawing Sheets**

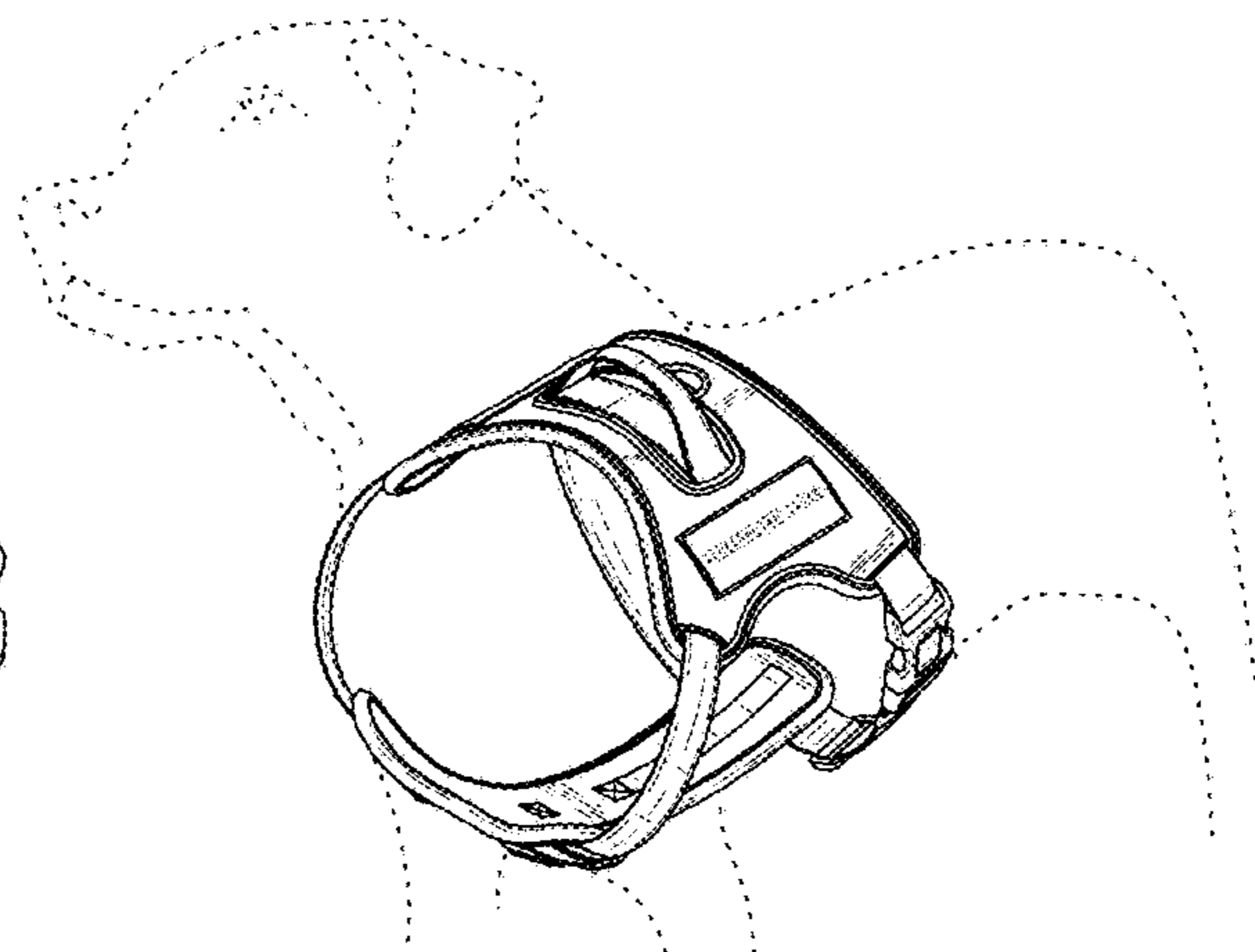
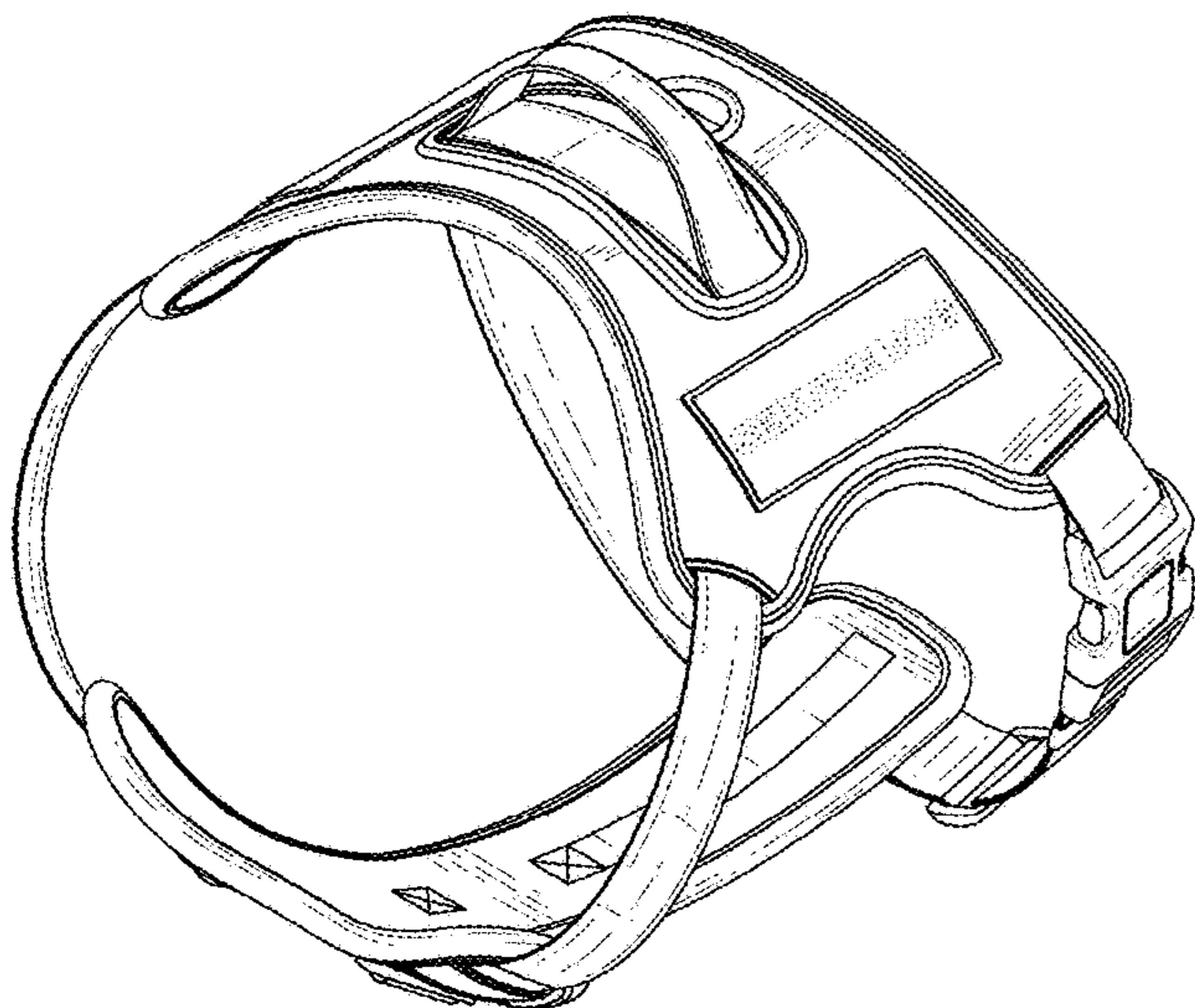

(58) **Field of Classification Search**  
 CPC .. A01K 27/002; A01K 1/0263; Y10S 119/907  
 See application file for complete search history.

(56) **References Cited**

U.S. PATENT DOCUMENTS

6,314,915	B1 *	11/2001	Pope .....	A01K 27/002 119/712
D569,050	S *	5/2008	Spatar .....	D30/151
D682,486	S *	5/2013	Sebo .....	A61D 9/00 D30/152
D753,350	S *	4/2016	Thitz .....	D30/144
D816,919	S *	5/2018	Drinkwater .....	D30/152
D816,920	S *	5/2018	Drinkwater .....	D30/152
D862,002	S *	10/2019	Wu .....	D30/152
D862,004	S *	10/2019	Yun .....	D30/152
D867,686	S *	11/2019	Yun .....	D30/152
2011/0271913	A1 *	11/2011	Min .....	A01K 27/002 119/856
2019/0124890	A1 *	5/2019	Kath .....	A01K 1/0263
2019/0364850	A1 *	12/2019	Kruse .....	A01K 27/002

OTHER PUBLICATIONS

“Dogline Quest No-Pull Dog Harness.” Found online Feb. 26, 2020 at [www.amazon.com](http://www.amazon.com). Product reviewed Jul. 23, 2019. Retrieved from URL: [https://www.amazon.com/Dogline-Removable-Reflective-Comfortable-Hardware/dp/B07TS92ZHS?ref\\_=ast\\_sto\\_dp&th=1](https://www.amazon.com/Dogline-Removable-Reflective-Comfortable-Hardware/dp/B07TS92ZHS?ref_=ast_sto_dp&th=1) (Year: 2019).\*

“Bolux Therapy Dog Harness.” Found online Feb. 26, 2020 at [www.amazon.com](http://www.amazon.com). Product reviewed Aug. 12, 2019. Retrieved from URL: [https://www.amazon.com/dp/b07sv6lxl?tag=admarketus-20&ref=pd\\_sl\\_a814048B20ADA1351A4E870E34](https://www.amazon.com/dp/b07sv6lxl?tag=admarketus-20&ref=pd_sl_a814048B20ADA1351A4E870E34) (Year: 2019).\*

“Ruffwear—Front Range Everyday No-Pull Dog Harness.” Found online Feb. 26, 2020 at [www.amazon.com](http://www.amazon.com). Product reviewed Sep. 18, 2014. Retrieved from URL: [https://www.amazon.com/dp/b01mr516mb?tag=admarketus-20&ref=pd\\_sl\\_a814048B20ADA1351A4E870E34](https://www.amazon.com/dp/b01mr516mb?tag=admarketus-20&ref=pd_sl_a814048B20ADA1351A4E870E34) (Year: 2014).\*

\* cited by examiner

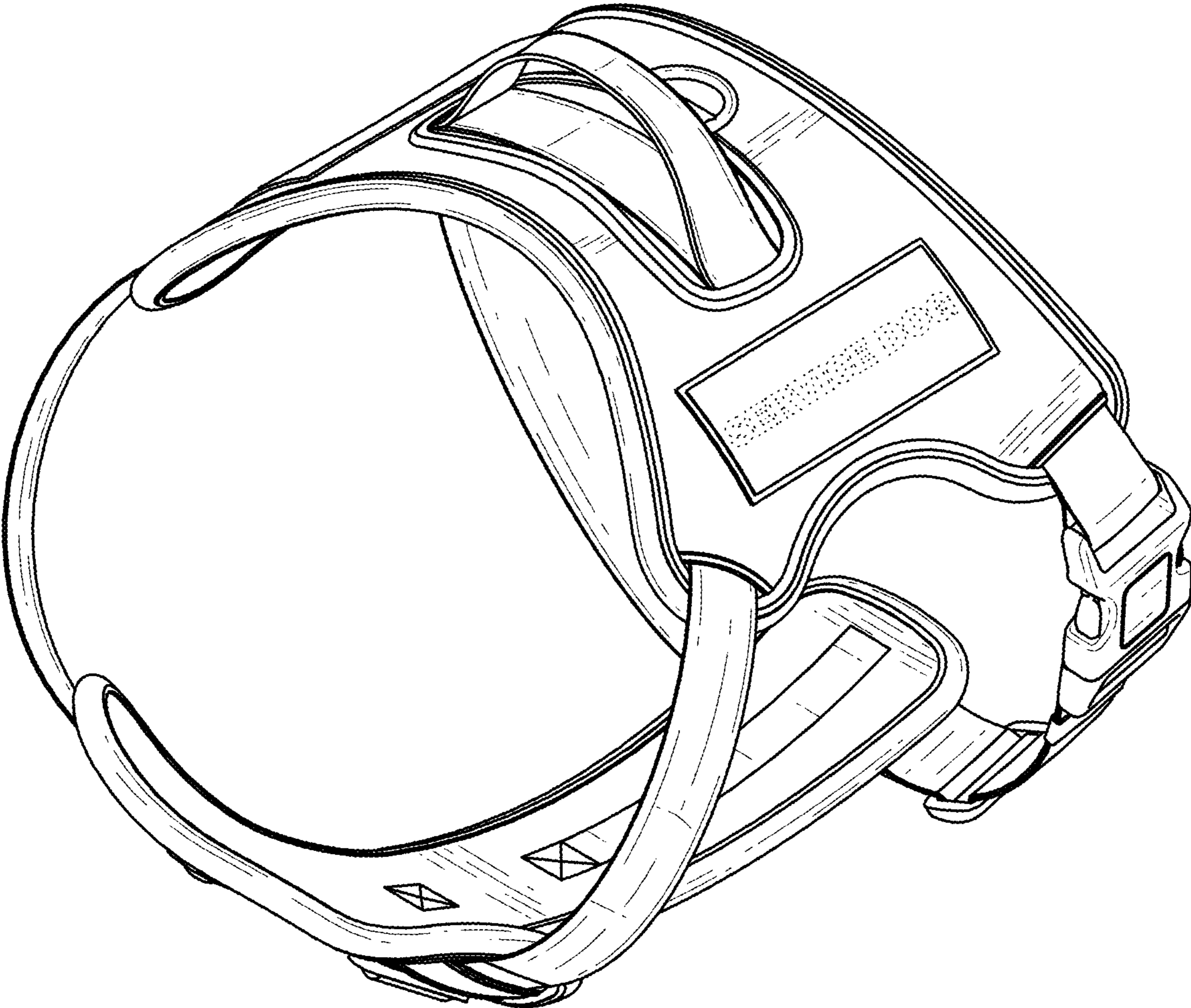

FIG. 1

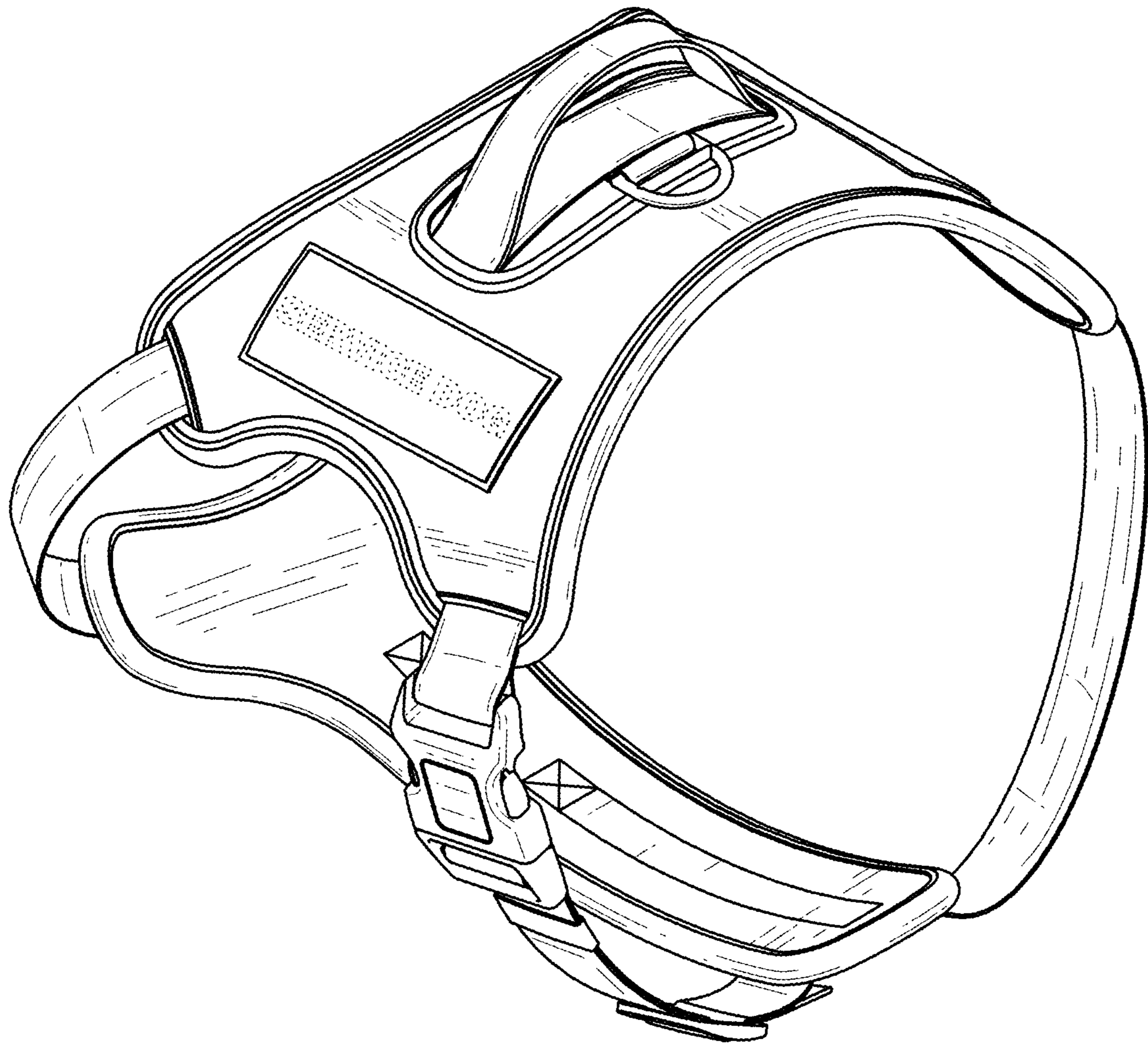

FIG. 2

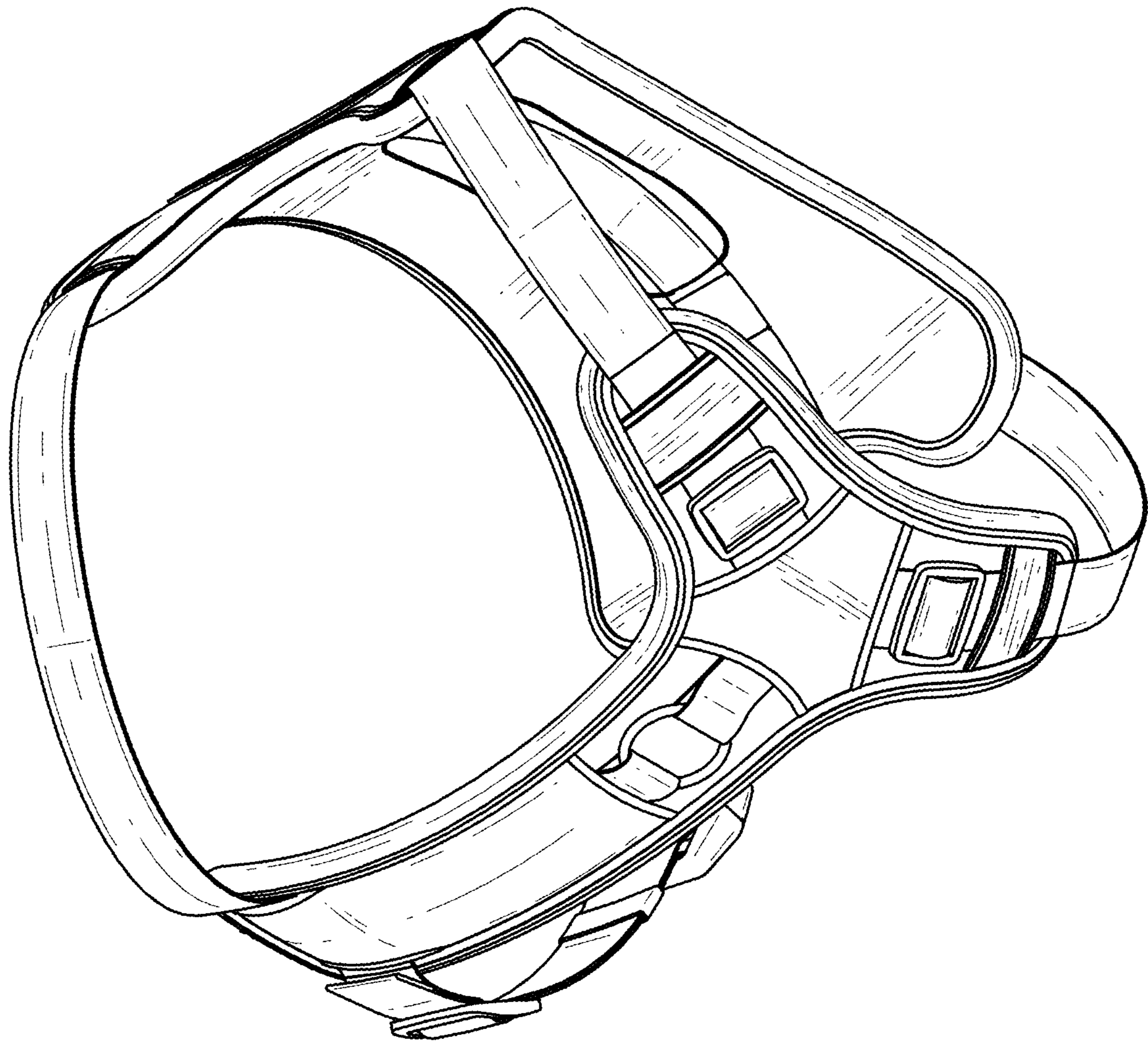

FIG. 3

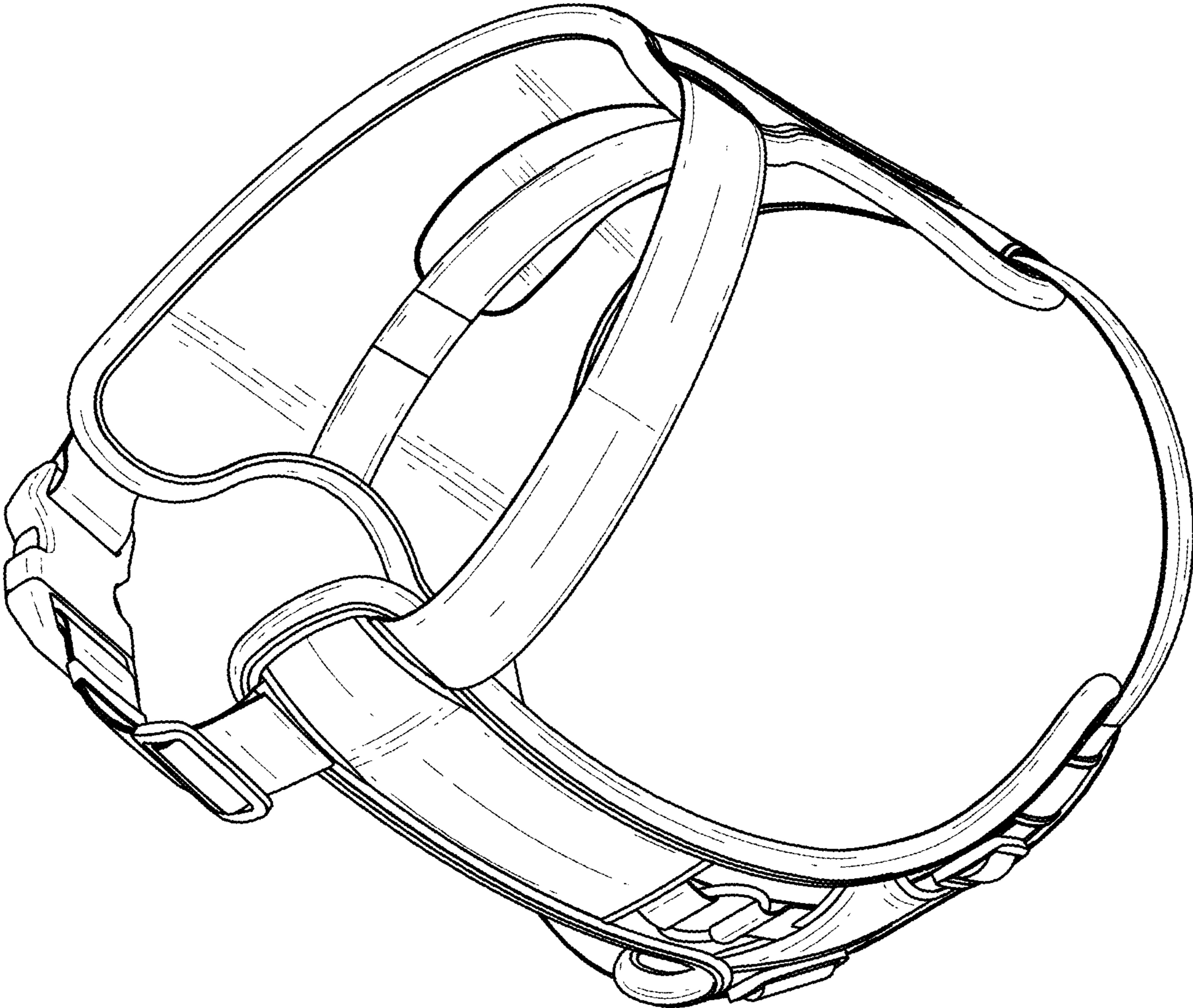

FIG. 4

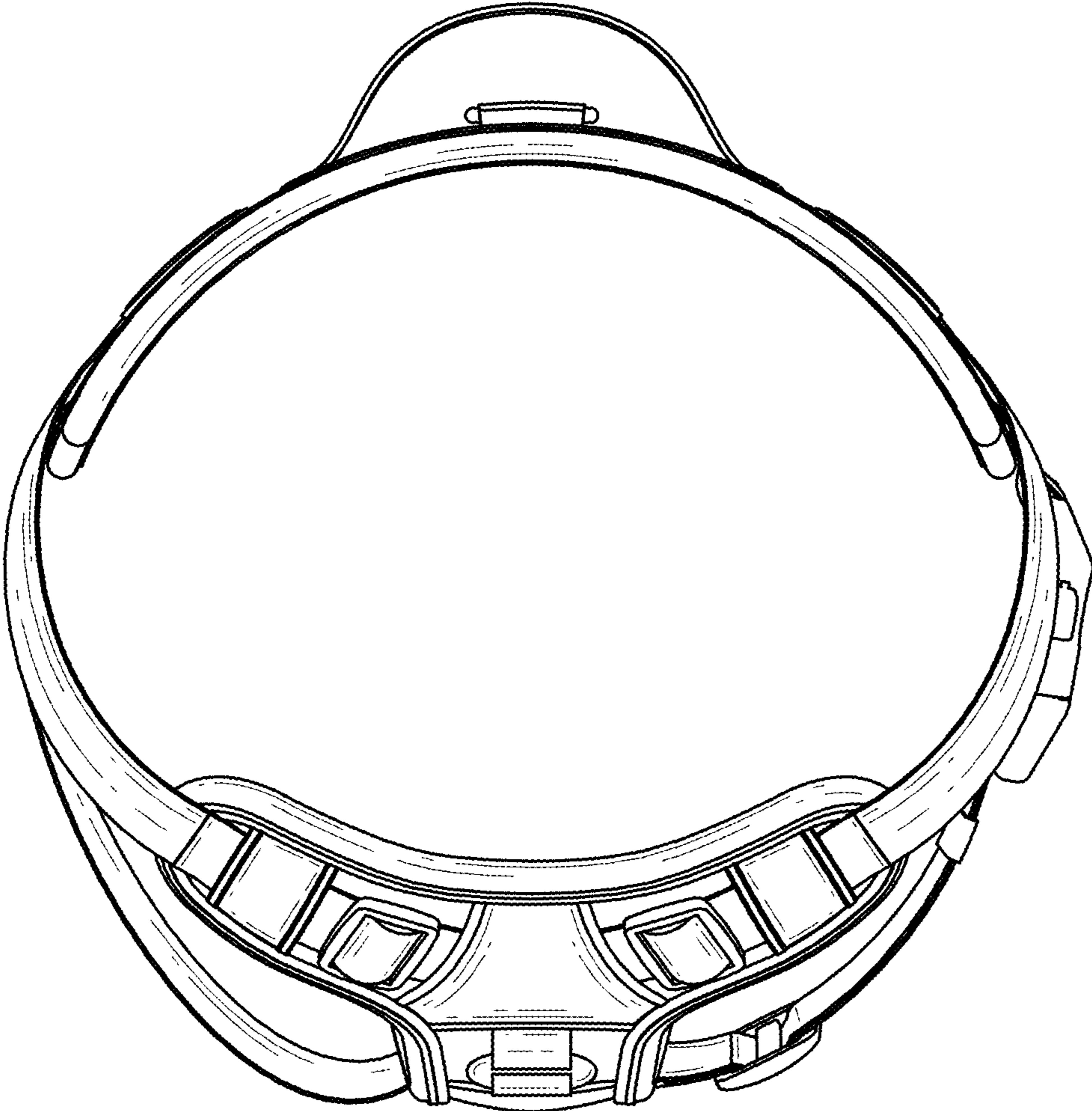

FIG. 5

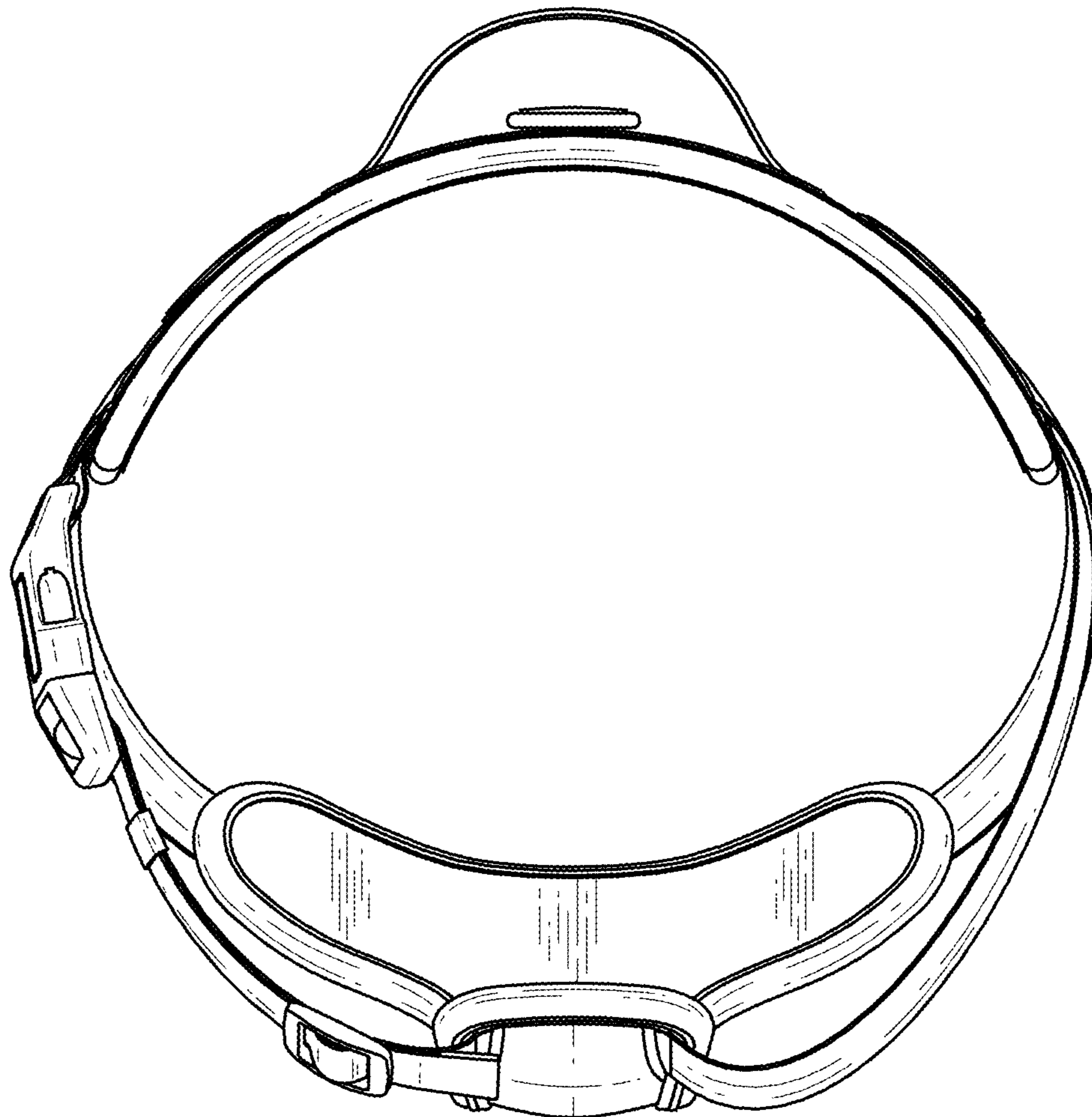

FIG. 6



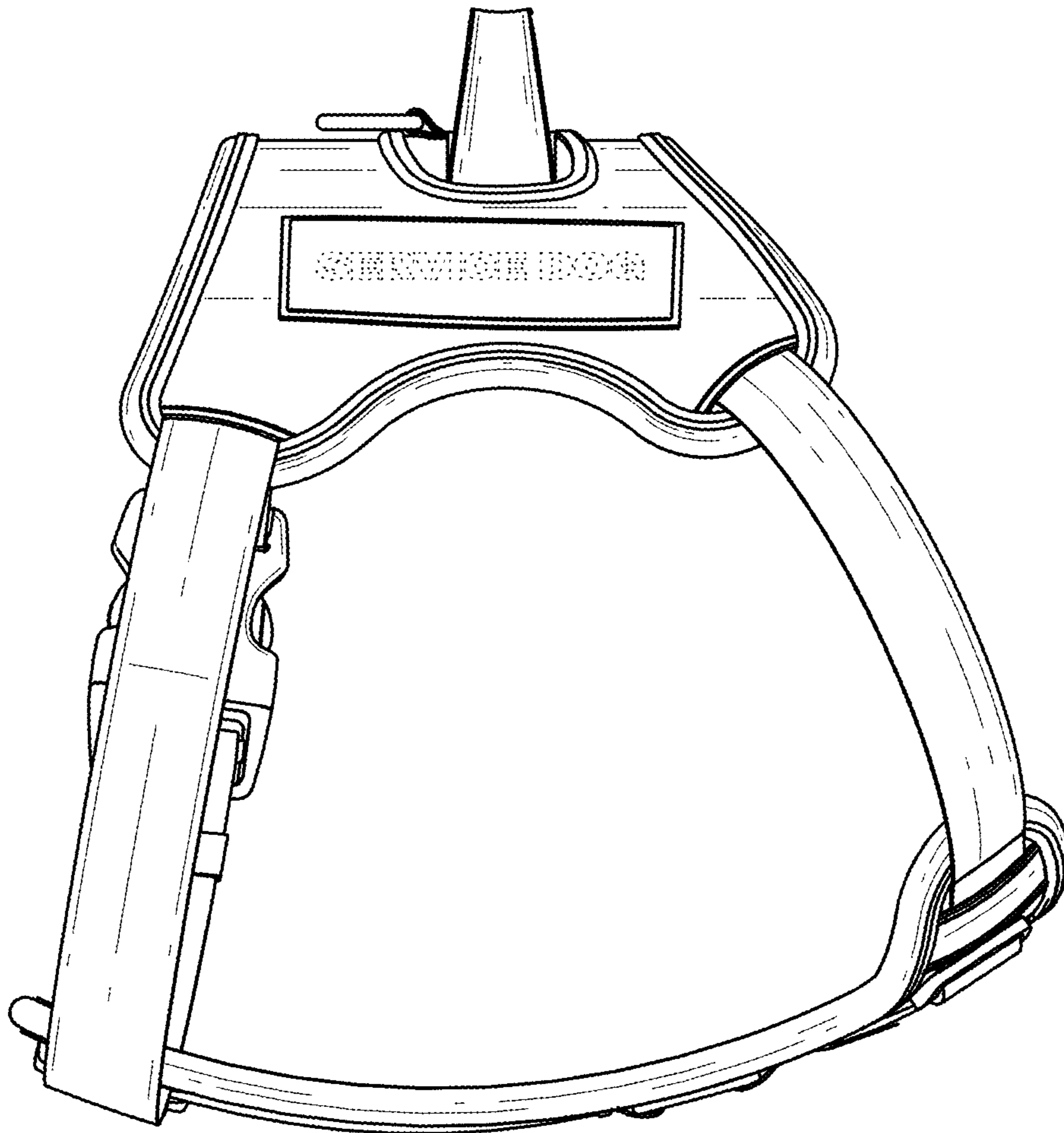

FIG. 7

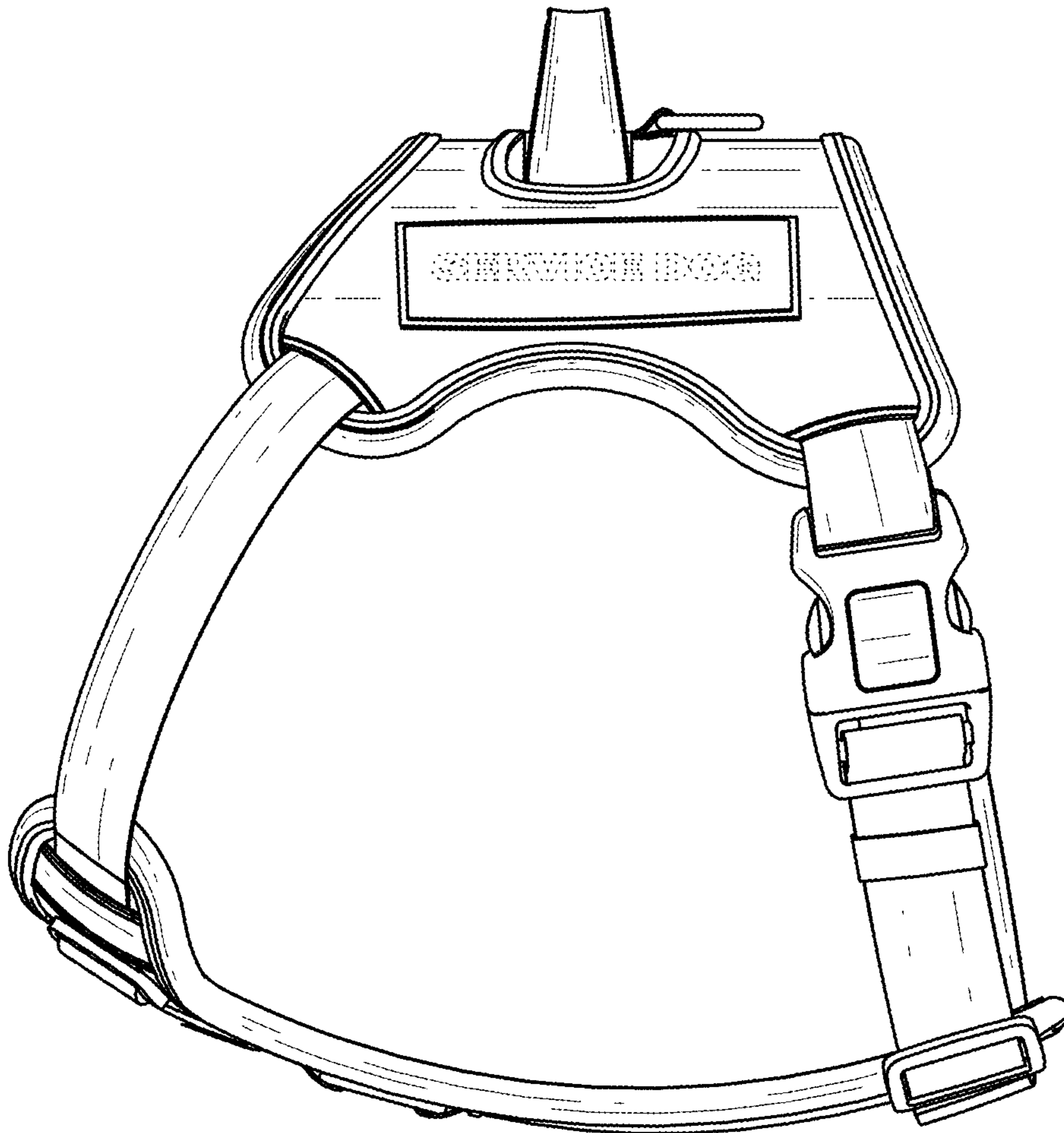

FIG. 8

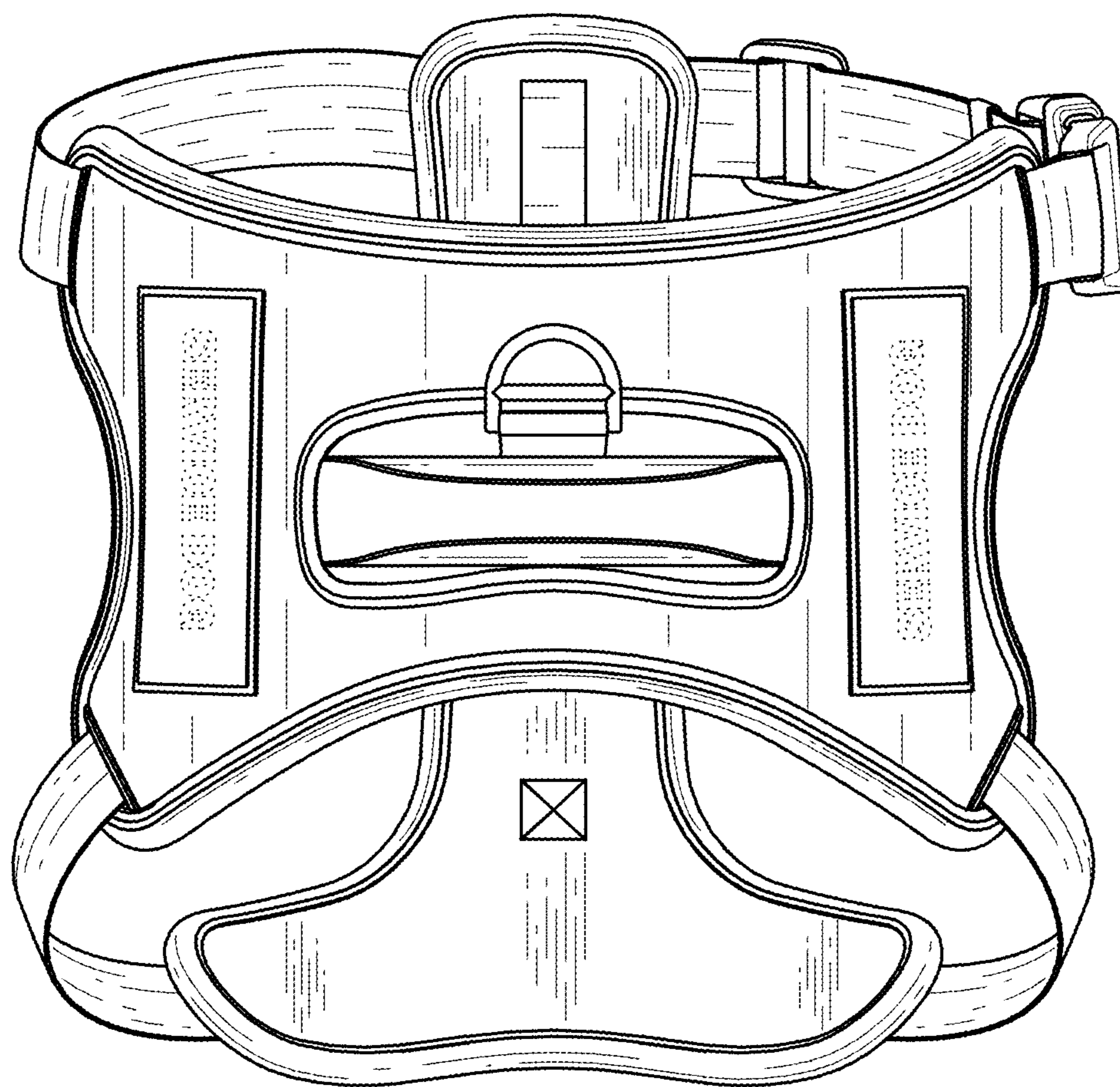

FIG. 9

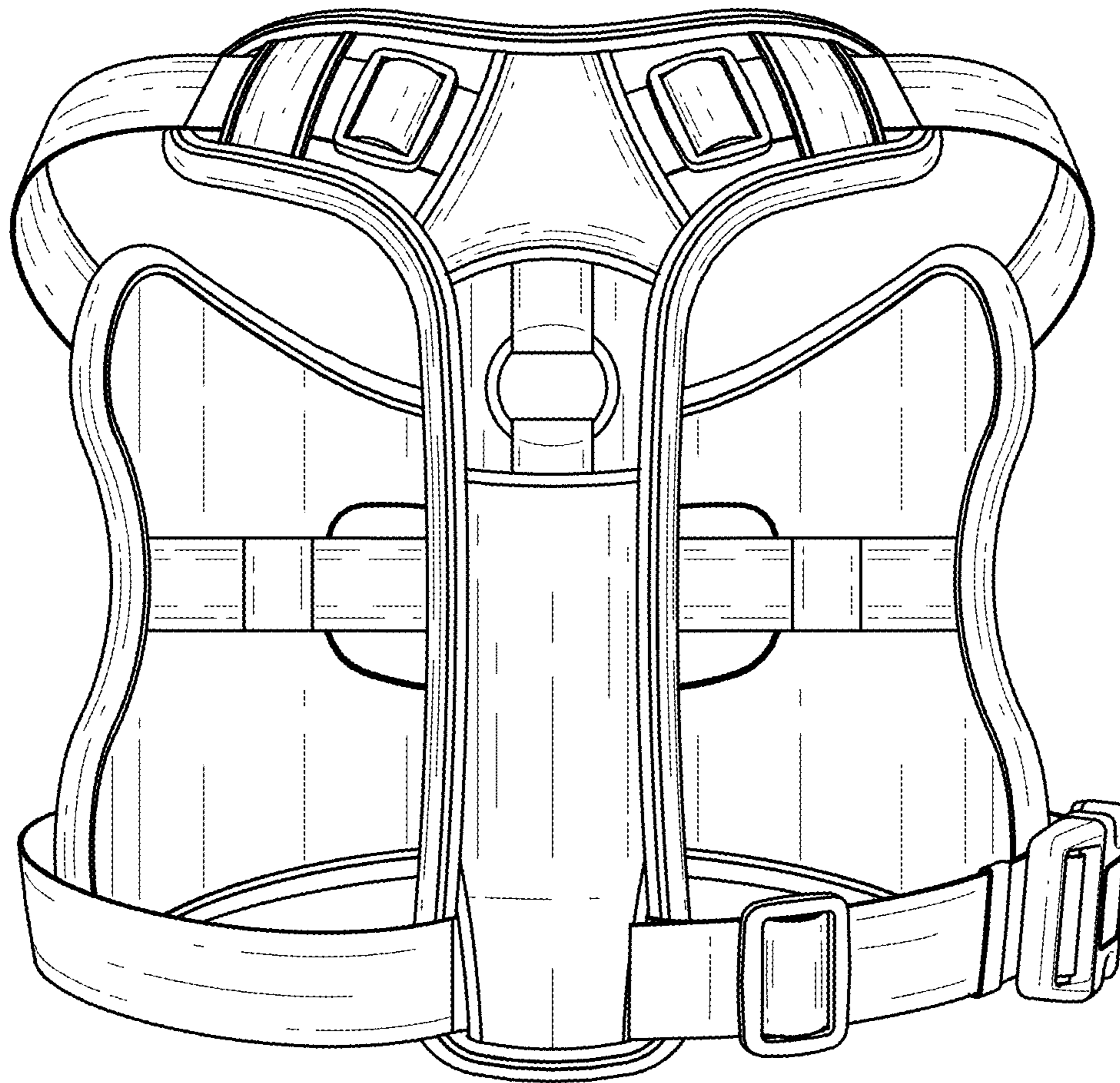

FIG. 10

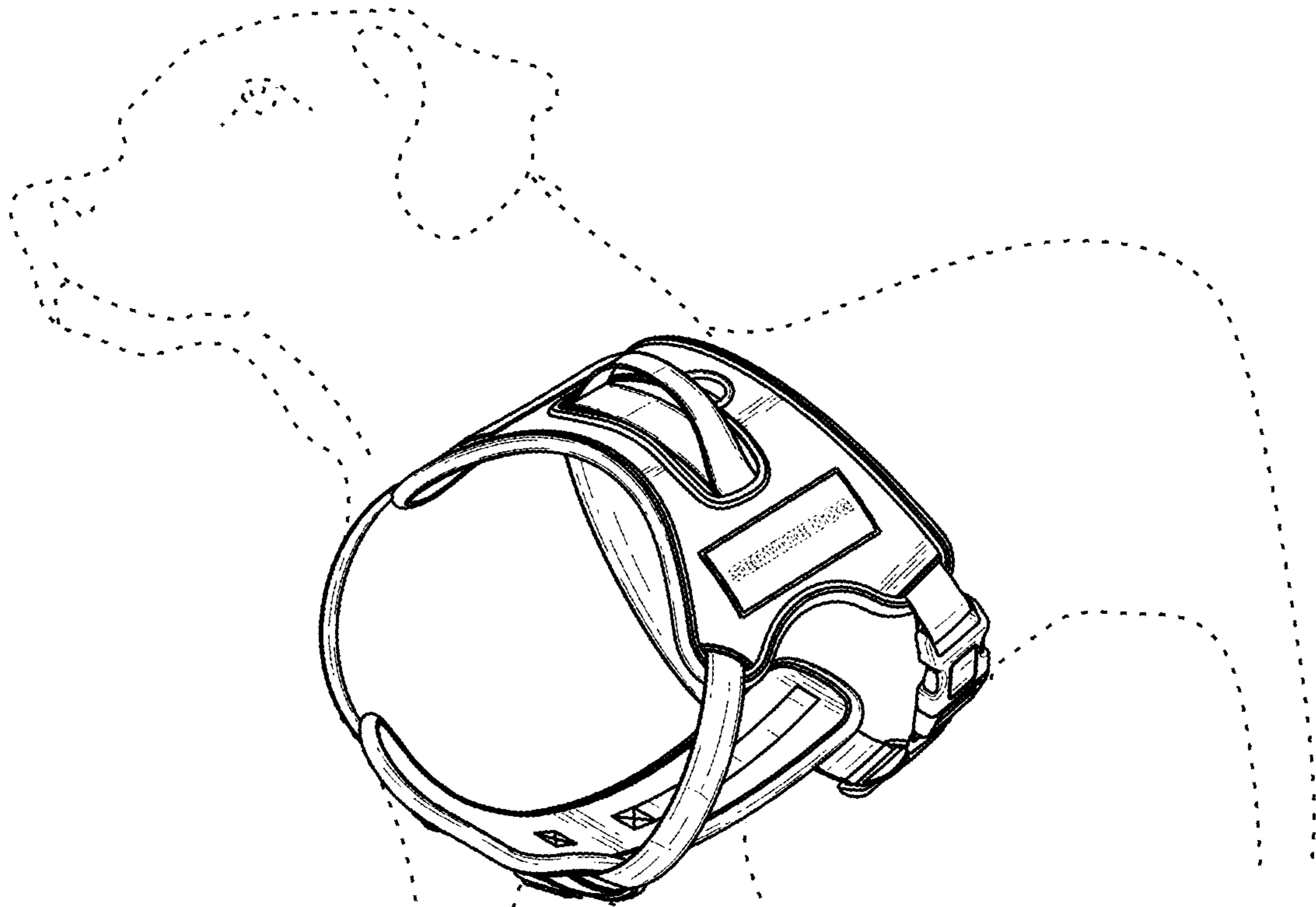

FIG. 11

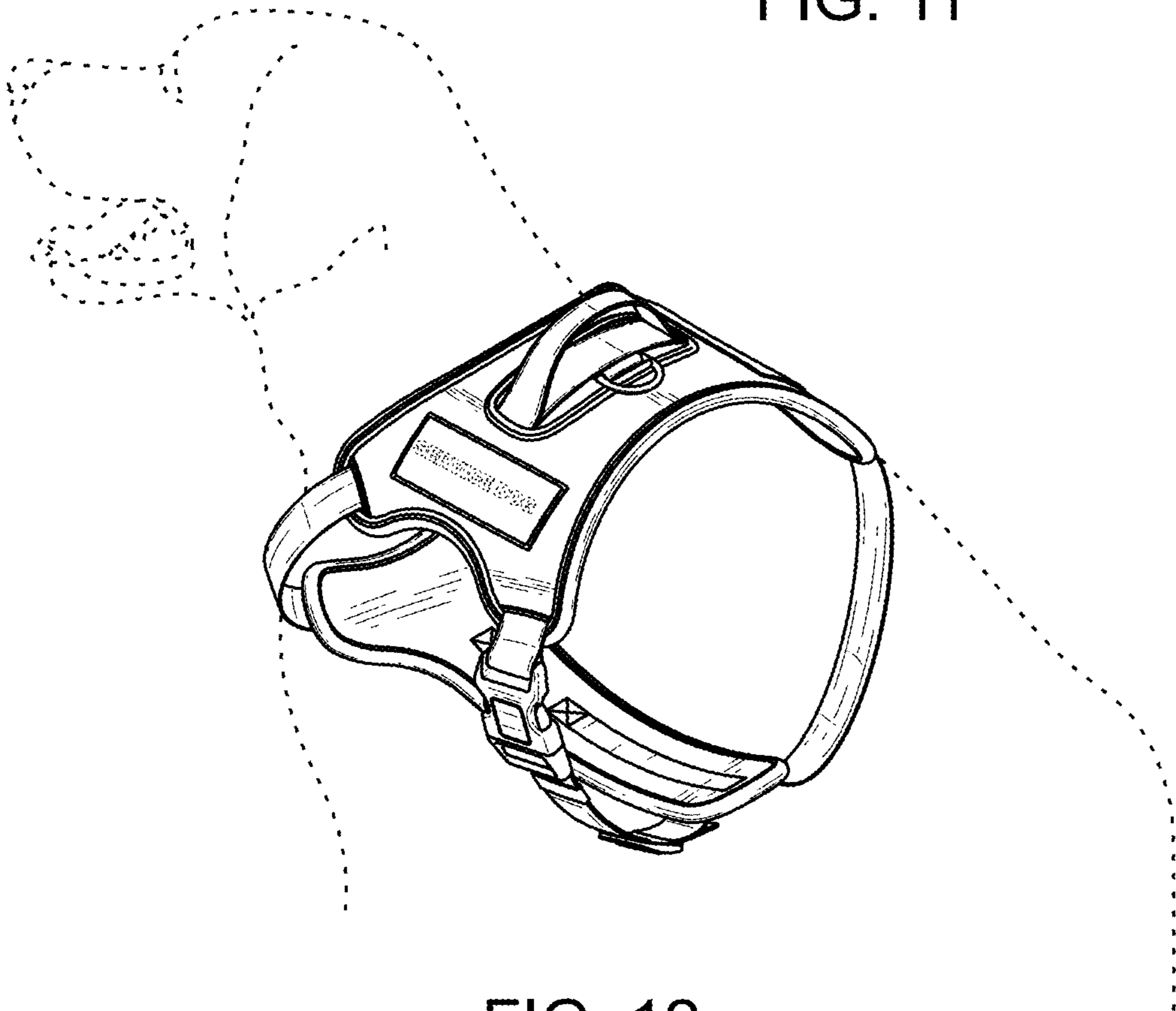

FIG. 12

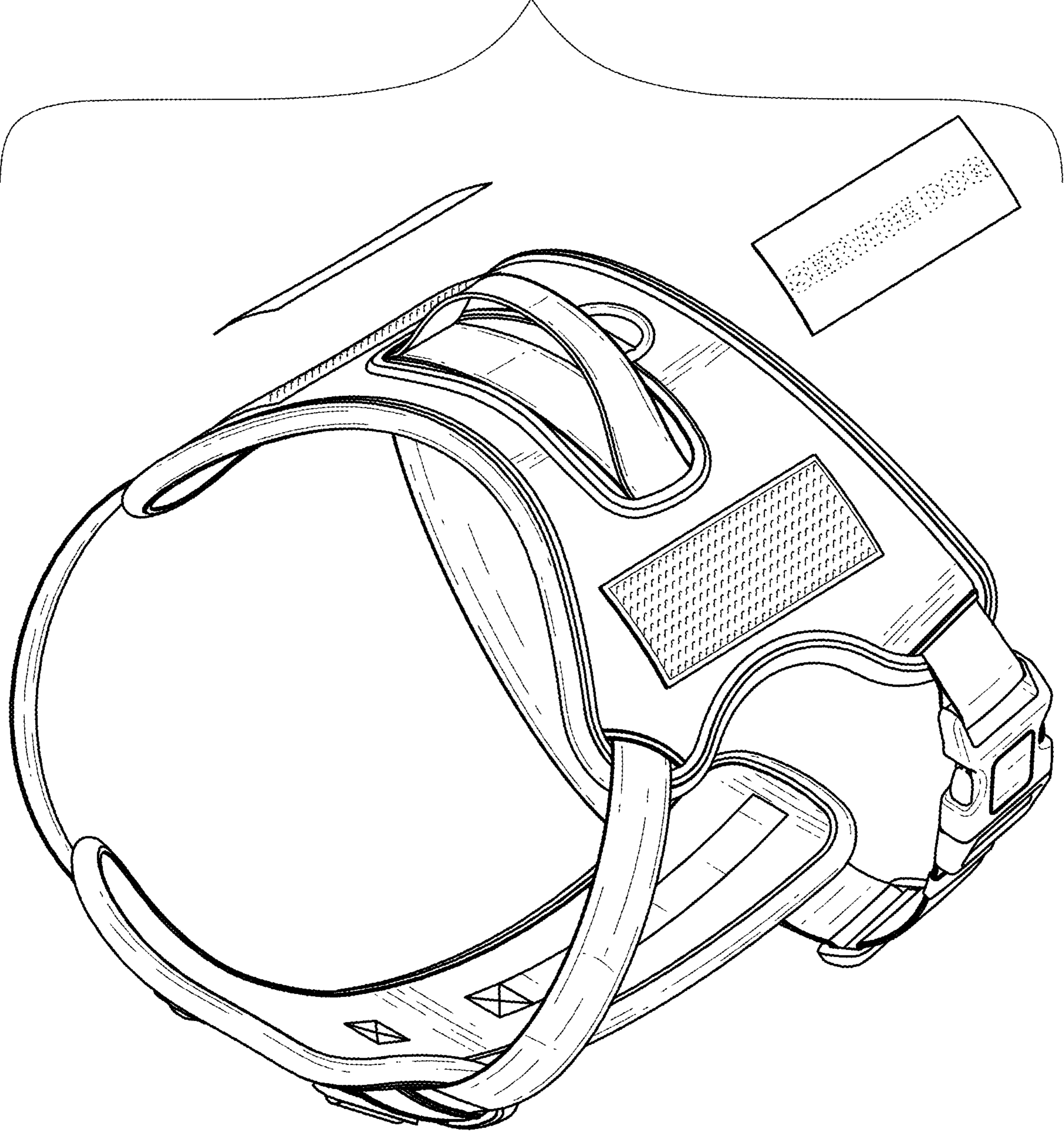

FIG. 13