



US00D889740S

(12) **United States Design Patent** (10) **Patent No.:** **US D889,740 S**
Beer et al. (45) **Date of Patent:** **** Jul. 7, 2020**

(54) **SMOKER'S ACCESSORY**
(71) Applicant: **Imperial Tobacco Ventures Limited,**
Bristol (GB)
(72) Inventors: **Andreas Beer,** Munich (DE); **Daniel**
Kegel, Munich (DE)
(**) Term: **15 Years**
(21) Appl. No.: **29/661,410**
(22) Filed: **Aug. 27, 2018**
(51) **LOC (12) Cl.** **27-99**
(52) **U.S. Cl.**
USPC **D27/194**
(58) **Field of Classification Search**
USPC D27/194, 100, 101, 162-165, 172, 183,
D27/185-192, 139, 127, 130, 142, 144,
D27/152-154, 157, 160; D24/202.21,
D24/203.12; 128/246, 247, 243;
131/273, 270, 191, 329, 330, 360-365
CPC A24F 9/10; A24F 9/04; A24F 9/02; A24F
9/08; A24F 9/00; A61M 15/06
See application file for complete search history.

D770,678 S * 11/2016 Shin D27/163
D772,477 S * 11/2016 Shin D27/163
D776,051 S * 1/2017 Wang D13/103
D801,507 S * 10/2017 Kelnhofer D23/366
D808,073 S * 1/2018 Leidel D27/162
D821,640 S * 6/2018 Qiu D27/162
D828,953 S * 9/2018 Chen D27/167
D834,746 S * 11/2018 Liu D27/162
D843,052 S * 3/2019 Powell D27/163
D851,328 S * 6/2019 Smith D27/162
D853,022 S * 7/2019 Srour D27/183

* cited by examiner
Primary Examiner — Susan Bennett Hattan
Assistant Examiner — Rebecca Tsehaye
(74) *Attorney, Agent, or Firm* — Bates & Bates, LLC

(56) **References Cited**
U.S. PATENT DOCUMENTS
D729,366 S * 5/2015 Kauss D23/360
D743,099 S * 11/2015 Oglesby D27/101
D748,324 S * 1/2016 Choi D27/163
D748,325 S * 1/2016 Leidel D27/163
D768,331 S * 10/2016 Chen D27/101
D769,520 S * 10/2016 Hua D27/167

(57) **CLAIM**
What is claimed is the ornamental design for smoker's accessory, as shown and described.

DESCRIPTION
FIG. 1 is a front perspective view of the smoker's accessory;
FIG. 2 is a right side view of the smoker's accessory;
FIG. 3 is a left side view of the smoker's accessory;
FIG. 4 is a front view of the smoker's accessory;
FIG. 5 is a back view of the smoker's accessory;
FIG. 6 is a top view of the smoker's accessory; and,
FIG. 7 is a bottom view of the smoker's accessory.
The broken lines in the drawings depict portions of the smoker's accessory that form no part of the claimed design.

1 Claim, 7 Drawing Sheets

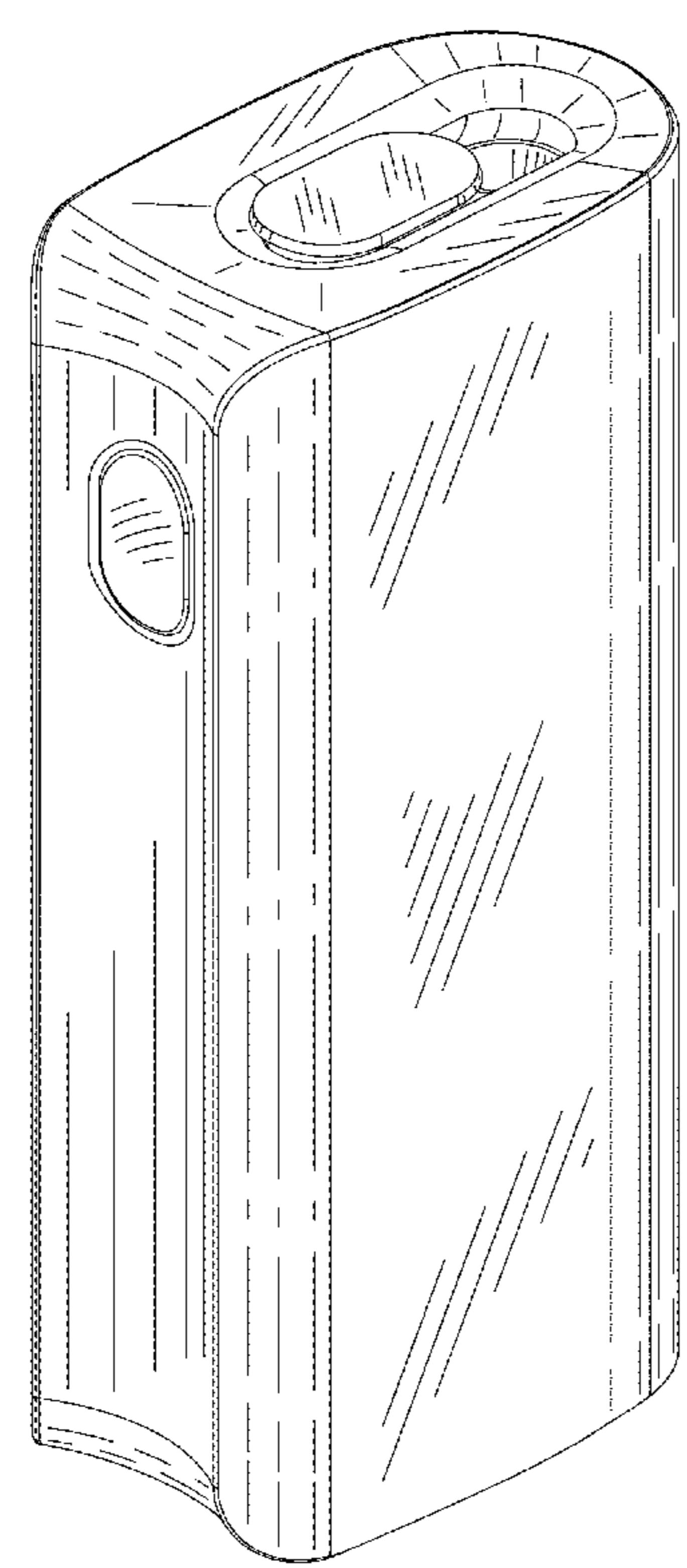

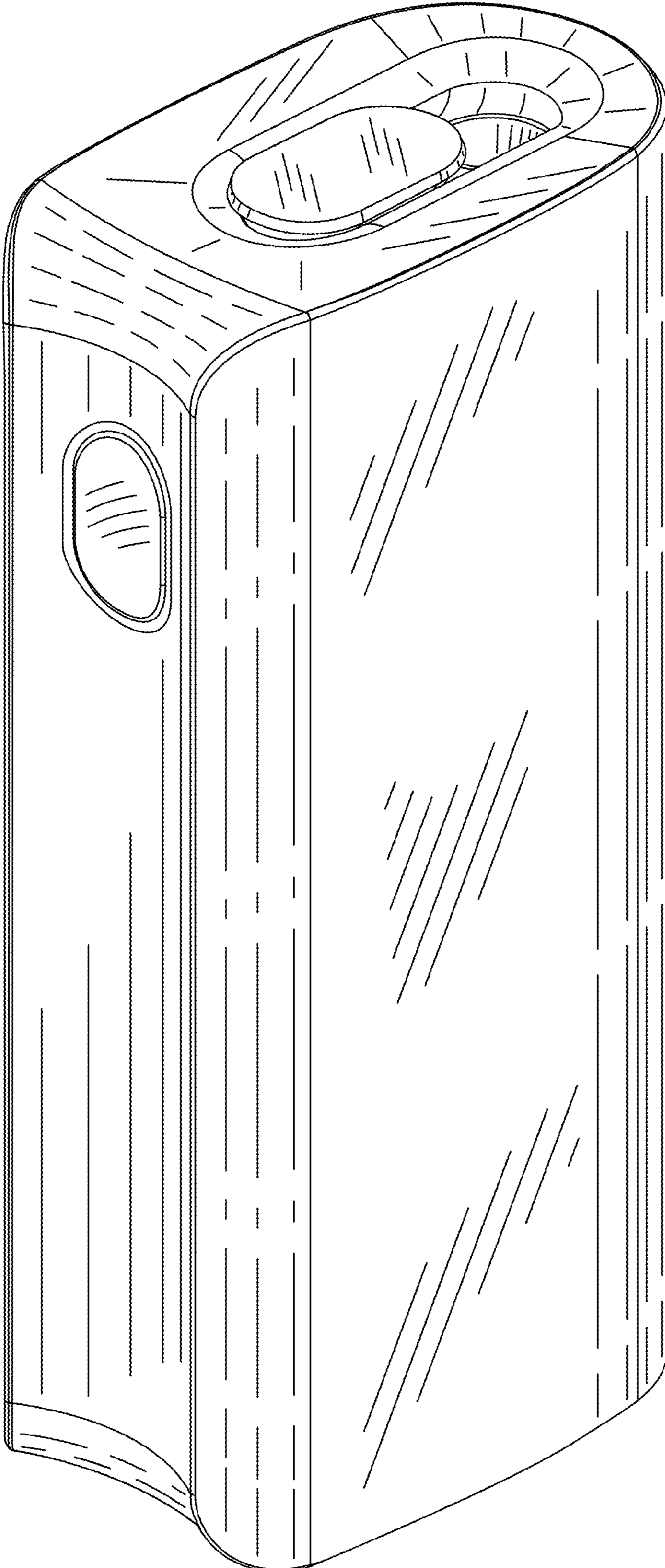

FIG. 1

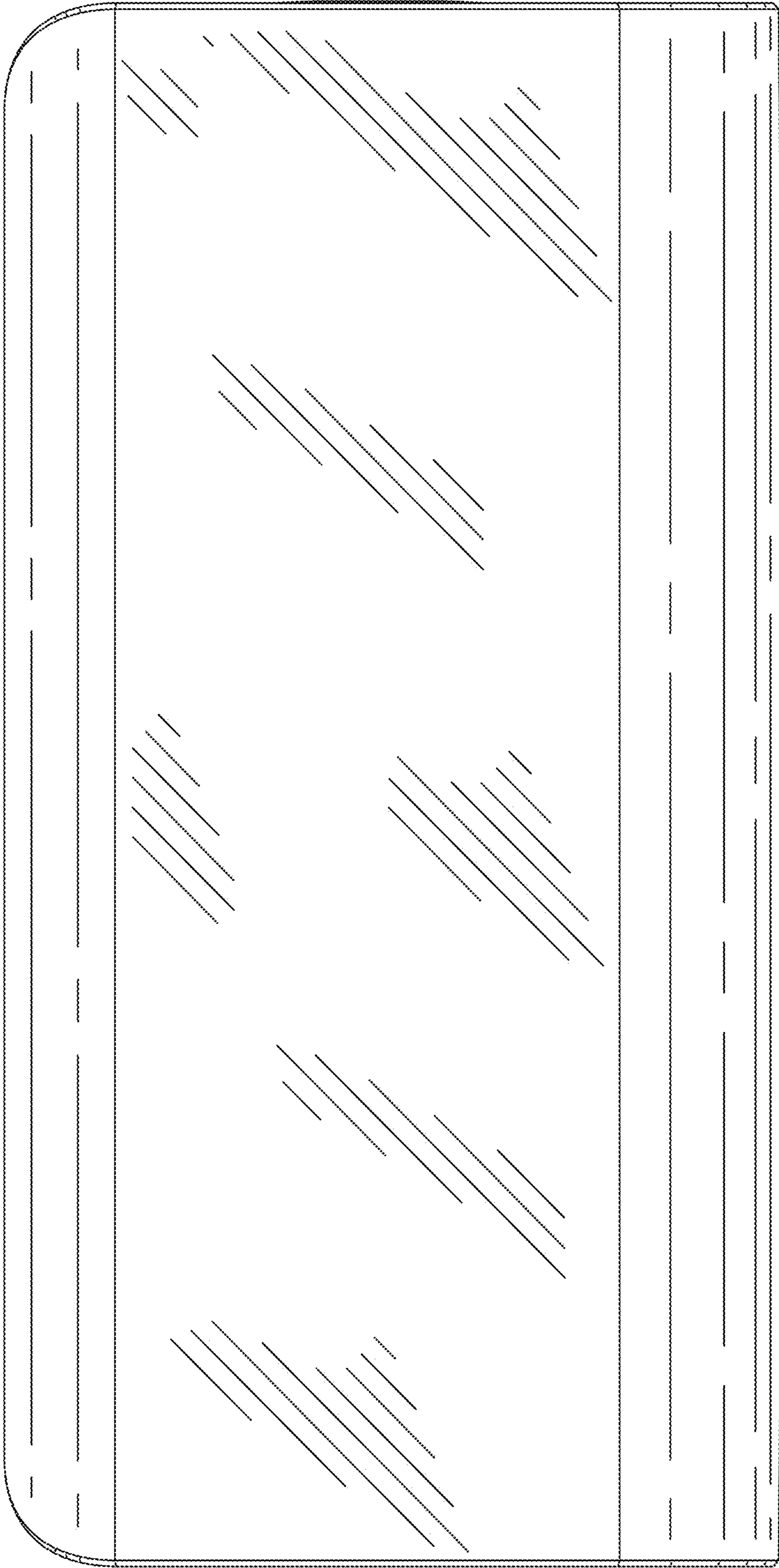

FIG. 2

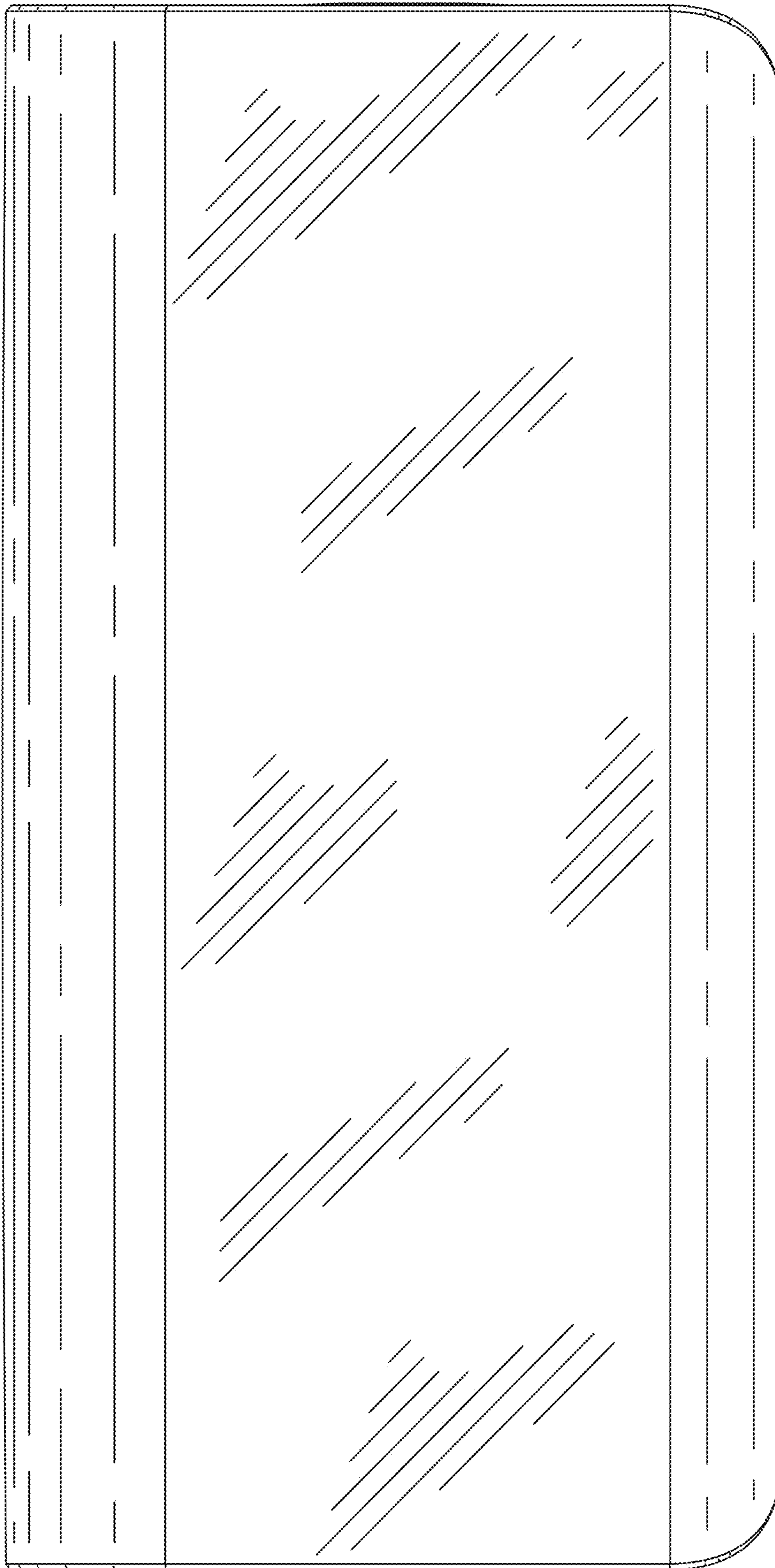

FIG. 3

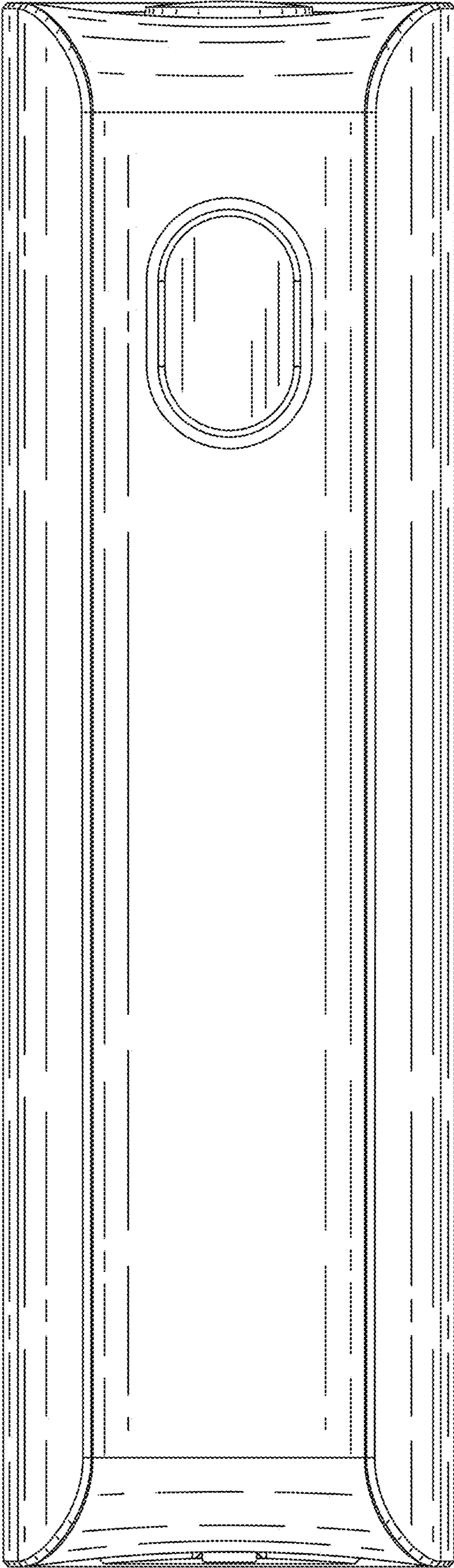

FIG. 4

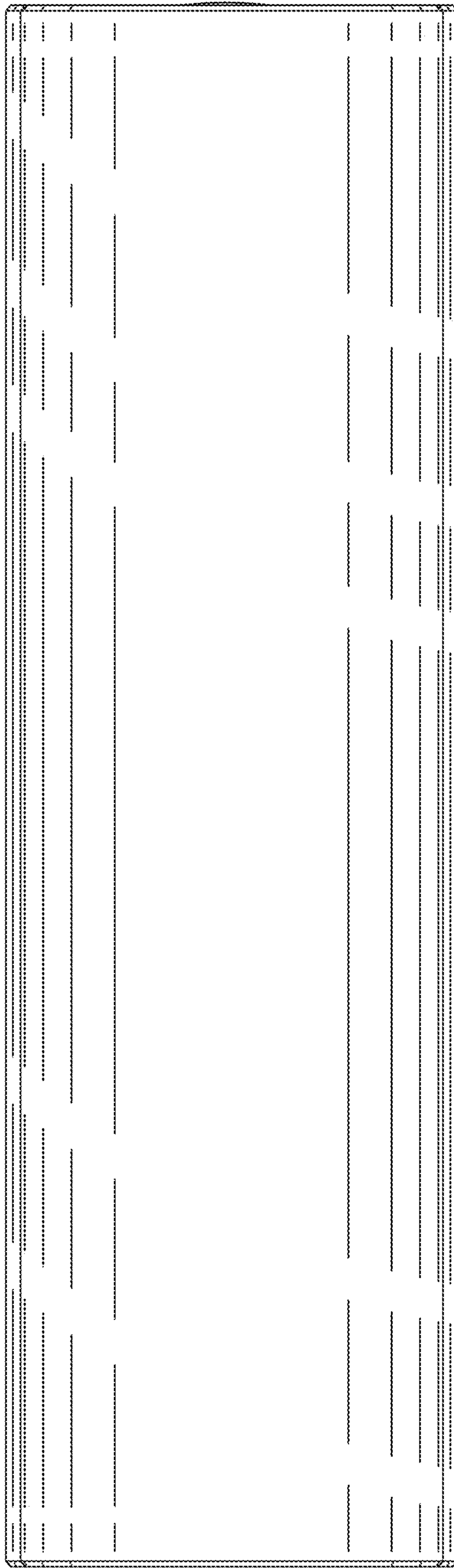

FIG. 5

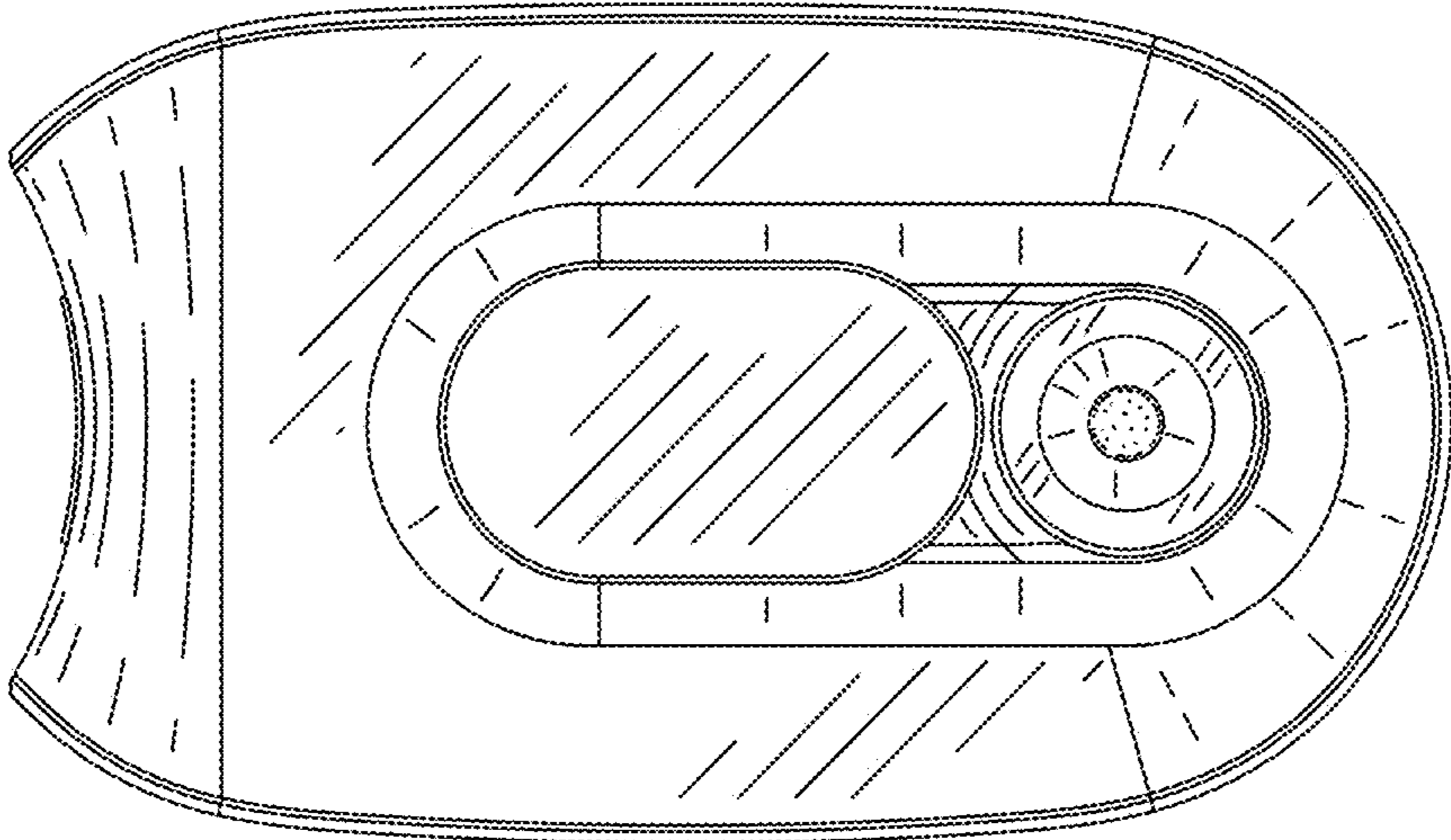

FIG. 6

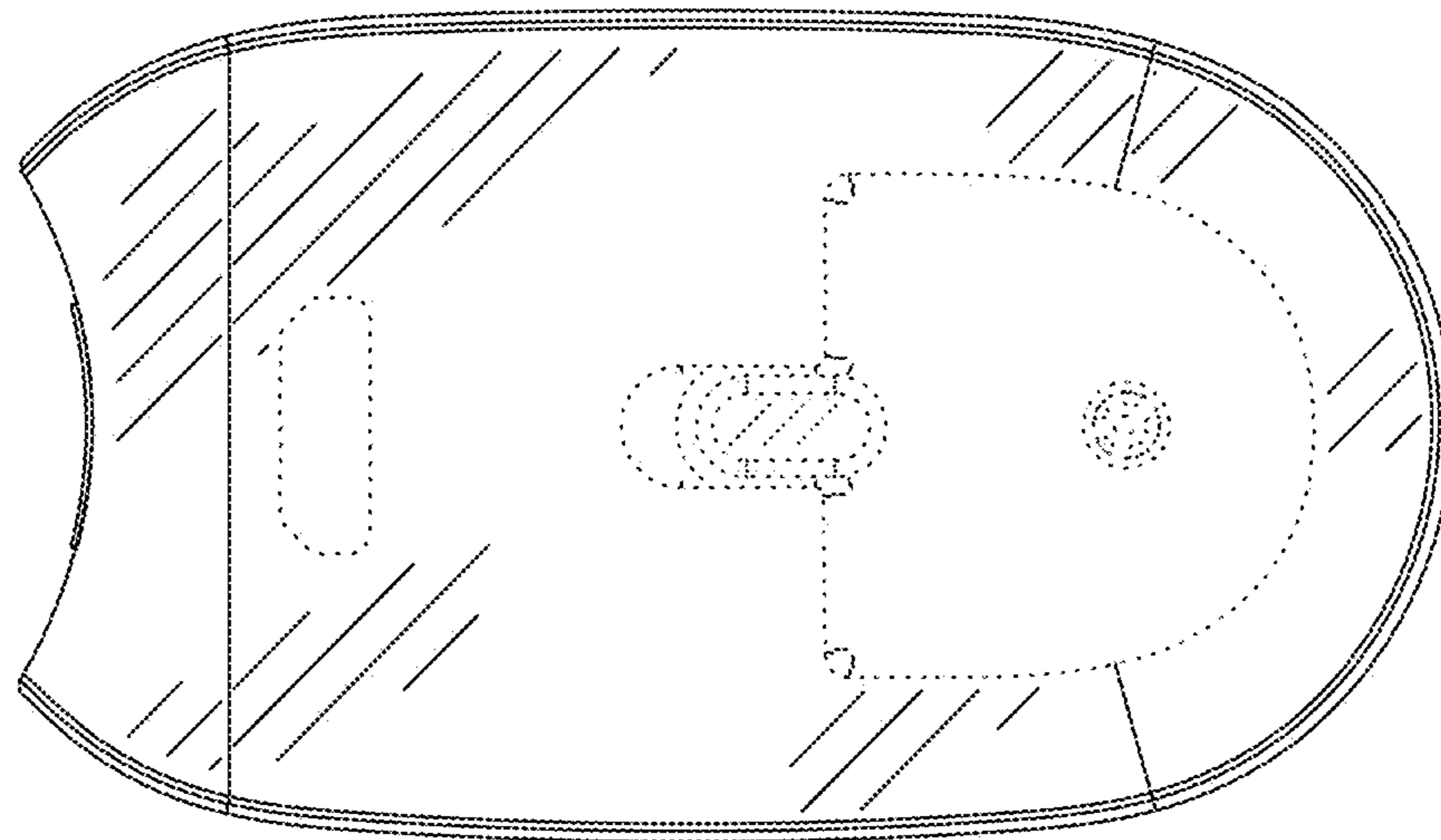

FIG. 7

UNITED STATES PATENT AND TRADEMARK OFFICE
CERTIFICATE OF CORRECTION

PATENT NO. : D889,740 S
APPLICATION NO. : 29/661410
DATED : July 7, 2020
INVENTOR(S) : Andreas Beer and Daniel Kegel

Page 1 of 1

It is certified that error appears in the above-identified patent and that said Letters Patent is hereby corrected as shown below:

On the Title Page

Add item (30):
(30) Foreign Application Priority Data
Feb. 27, 2018 (EM).....RCD 004729507

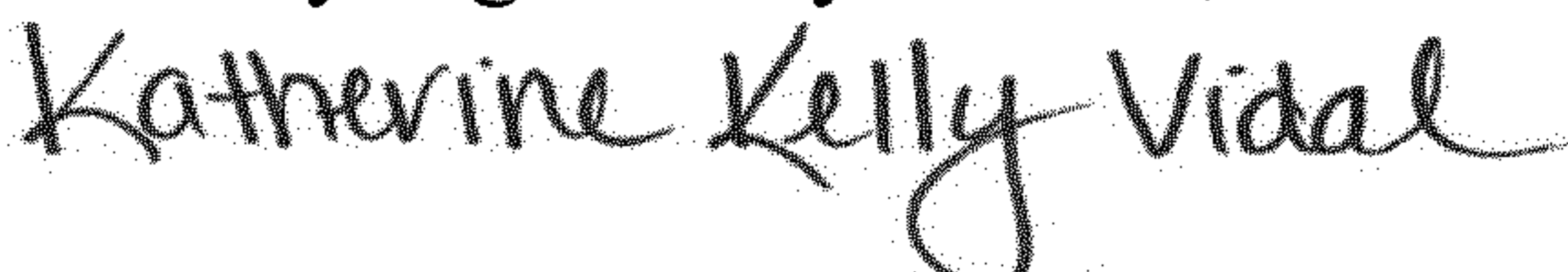
Signed and Sealed this
Twenty-eighth Day of June, 2022

Katherine Kelly Vidal
Director of the United States Patent and Trademark Office