



US00D889732S

(12) **United States Design Patent**
Silver

(10) **Patent No.:** **US D889,732 S**

(45) **Date of Patent:** **** Jul. 7, 2020**

(54) **LUMINAIRE**

(71) Applicant: **Beta-Calco, Inc.**, Toronto, Ontario
(CA)

(72) Inventor: **Remy Silver**, Toronto (CA)

(73) Assignee: **Beta-Calco, Inc.**, Toronto (CA)

(**) Term: **15 Years**

(21) Appl. No.: **29/654,010**

(22) Filed: **Jun. 20, 2018**

Related U.S. Application Data

(62) Division of application No. 29/597,366, filed on Mar. 16, 2017, now Pat. No. Des. 835,333.

(30) **Foreign Application Priority Data**

Nov. 4, 2016 (CA) 171374

(51) **LOC (12) Cl.** **26-99**

(52) **U.S. Cl.**
USPC **D26/113**

(58) **Field of Classification Search**

USPC D26/1, 24, 93, 94, 113, 76, 141; D6/300,
D6/661.1; D25/115; D11/132;
D10/114.1, 114.2, 113.4; D23/366

(Continued)

(56) **References Cited**

U.S. PATENT DOCUMENTS

D548,827 S * 8/2007 Pivert D23/366
D604,894 S * 11/2009 Peifer D26/141

(Continued)

Primary Examiner — Brian N. Vinson

(74) *Attorney, Agent, or Firm* — Renner, Otto, Boisselle
& Sklar, LLP

(57) **CLAIM**

The ornamental design for a luminaire, as shown and described.

DESCRIPTION

FIG. 1 is a front view of a luminaire showing a seventh variant of the design, the rear view being a mirror image thereof;

FIG. 2 is a left side view of the luminaire of FIG. 1, the right side view being a mirror image thereof;

FIG. 3 is a bottom view of the luminaire of FIG. 1;

FIG. 4 is a top view of the luminaire of FIG. 1;

FIG. 5 is a perspective view of the luminaire of FIG. 1;

FIG. 6 is an enlarged fragmentary view of the portion of the luminaire identified in FIG. 3;

FIG. 7 is a front view of a luminaire showing an eighth variant of the design, the rear view being a mirror image thereof;

FIG. 8 is a left side view of the luminaire of FIG. 7, the right side view being a mirror image thereof;

FIG. 9 is a bottom view of the luminaire of FIG. 7;

FIG. 10 is a top view of the luminaire of FIG. 7;

FIG. 11 is a perspective view of the luminaire of FIG. 7;

FIG. 12 is an enlarged fragmentary view of the portion of the luminaire identified in FIG. 9;

FIG. 13 is a front view of a luminaire showing a ninth variant of the design, the rear view being a mirror image thereof;

FIG. 14 is a left side view of the luminaire of FIG. 13, the right side view being a mirror image thereof;

FIG. 15 is a bottom view of the luminaire of FIG. 13;

FIG. 16 is a top view of the luminaire of FIG. 13;

FIG. 17 is a perspective view of the luminaire of FIG. 13;

FIG. 18 is an enlarged fragmentary view of the portion of the luminaire identified in FIG. 15;

FIG. 19 is a front view of a luminaire showing a tenth variant of the design, the rear view being a mirror image thereof;

FIG. 20 is a left side view of the luminaire of FIG. 19, the right side view being a mirror image thereof;

FIG. 21 is a bottom view of the luminaire of FIG. 19;

FIG. 22 is a top view of the luminaire of FIG. 19;

FIG. 23 is a perspective view of the luminaire of FIG. 19;

(Continued)

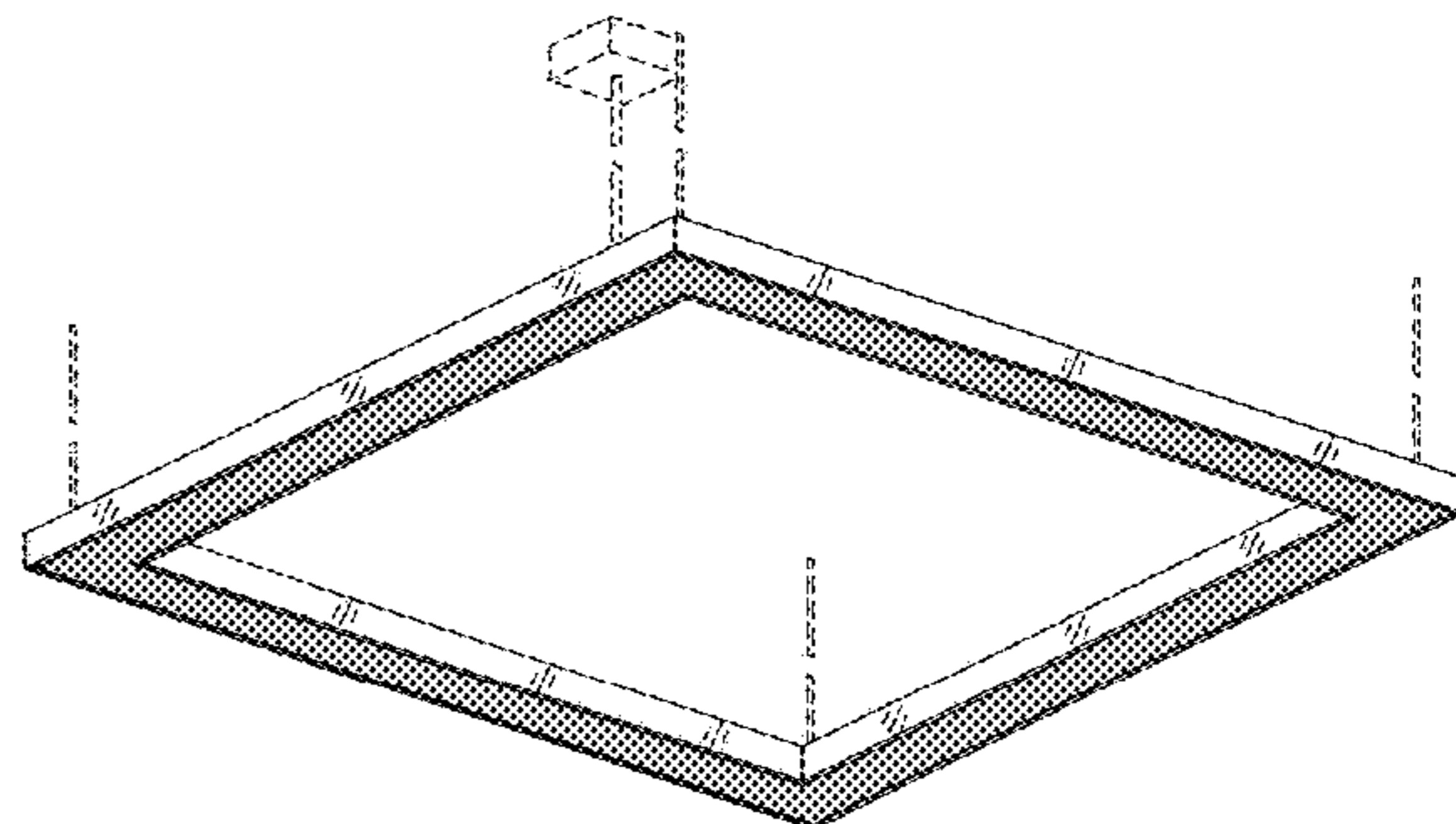
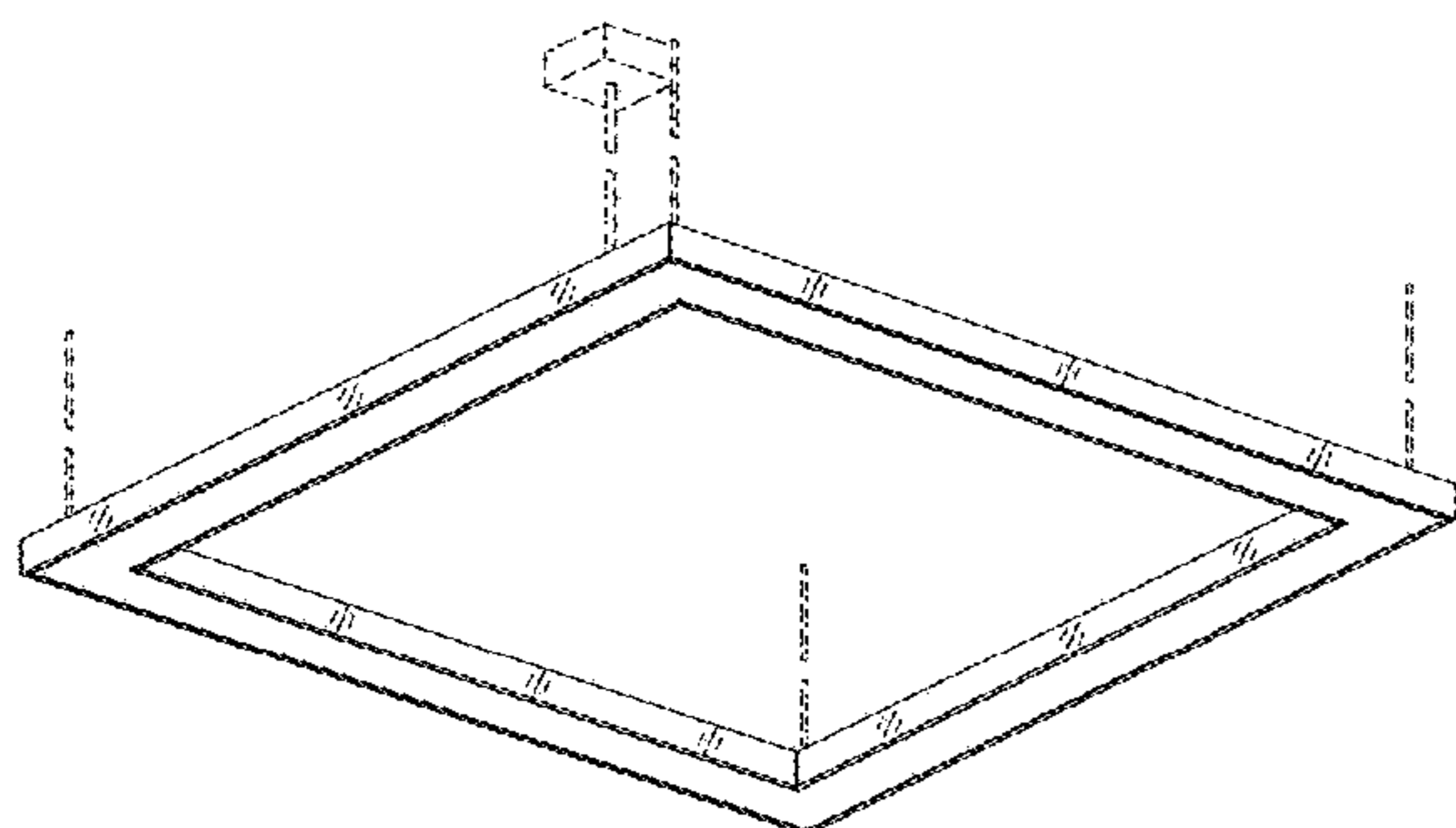

FIG. 24 is an enlarged fragmentary view of the portion of the luminaire identified in FIG. 21;
 FIG. 25 is a front view of a luminaire showing an eleventh variant of the design, the rear view being a mirror image thereof;
 FIG. 26 is a left side view of the luminaire of FIG. 25, the right side view being a mirror image thereof;
 FIG. 27 is a bottom view of the luminaire of FIG. 25;
 FIG. 28 is a top view of the luminaire of FIG. 25;
 FIG. 29 is a perspective view of the luminaire of FIG. 25;
 FIG. 30 is an enlarged fragmentary view of the portion of the luminaire identified in FIG. 27;
 FIG. 31 is a front view of a luminaire showing a twelfth variant of the design, the rear view being a mirror image thereof;
 FIG. 32 is a left side view of the luminaire of FIG. 31, the right side view being a mirror image thereof;
 FIG. 33 is a bottom view of the luminaire of FIG. 31;
 FIG. 34 is a top view of the luminaire of FIG. 31;
 FIG. 35 is a perspective view of the luminaire of FIG. 31;
 FIG. 36 is an enlarged fragmentary view of the portion of the luminaire identified in FIG. 33;
 FIG. 37 is a front view of a luminaire showing a thirteenth variant of the design, the rear view being a mirror image thereof;
 FIG. 38 is a left side view of the luminaire of FIG. 37, the right side view being a mirror image thereof;
 FIG. 39 is a bottom view of the luminaire of FIG. 37;
 FIG. 40 is a top view of the luminaire of FIG. 37;
 FIG. 41 is a perspective view of the luminaire of FIG. 37;
 FIG. 42 is an enlarged fragmentary view of the portion of the luminaire identified in FIG. 37;
 FIG. 43 is a front view of a luminaire showing a fourteenth variant of the design, the rear view being a mirror image thereof;
 FIG. 44 is a left side view of the luminaire of FIG. 43, the right side view being a mirror image thereof;
 FIG. 45 is a bottom view of the luminaire of FIG. 43;
 FIG. 46 is a top view of the luminaire of FIG. 43;
 FIG. 47 is a perspective view of the luminaire of FIG. 43;
 FIG. 48 is an enlarged fragmentary view of the portion of the luminaire identified in FIG. 43;
 FIG. 49 is a front view of a luminaire showing a fifteenth variant of the design, the rear view being a mirror image thereof;
 FIG. 50 is a left side view of the luminaire of FIG. 49, the right side view being a mirror image thereof;
 FIG. 51 is a bottom view of the luminaire of FIG. 49;
 FIG. 52 is a top view of the luminaire of FIG. 49;
 FIG. 53 is a perspective view of the luminaire of FIG. 49;
 FIG. 54 is an enlarged fragmentary view of the portion of the luminaire identified in FIG. 49;

FIG. 55 is a front view of a luminaire showing a sixteenth variant of the design, the rear view being a mirror image thereof;
 FIG. 56 is a left side view of the luminaire of FIG. 55, the right side view being a mirror image thereof;
 FIG. 57 is a bottom view of the luminaire of FIG. 55;
 FIG. 58 is a top view of the luminaire of FIG. 55;
 FIG. 59 is a perspective view of the luminaire of FIG. 55;
 FIG. 60 is an enlarged fragmentary view of the portion of the luminaire identified in FIG. 55;
 FIG. 61 is a front view of a luminaire showing a seventeenth variant of the design, the rear view being a mirror image thereof;
 FIG. 62 is a left side view of the luminaire of FIG. 61, the right side view being a mirror image thereof;
 FIG. 63 is a bottom view of the luminaire of FIG. 61;
 FIG. 64 is a top view of the luminaire of FIG. 61;
 FIG. 65 is a perspective view of the luminaire of FIG. 61;
 FIG. 66 is an enlarged fragmentary view of the portion of the luminaire identified in FIG. 61;
 FIG. 67 is a front view of a luminaire showing an eighteenth variant of the design, the rear view being a mirror image thereof;
 FIG. 68 is a left side view of the luminaire of FIG. 67, the right side view being a mirror image thereof;
 FIG. 69 is a bottom view of the luminaire of FIG. 67;
 FIG. 70 is a top view of the luminaire of FIG. 67;
 FIG. 71 is a perspective view of the luminaire of FIG. 67;
 and,
 FIG. 72 is an enlarged fragmentary view of the portion of the luminaire identified in FIG. 67.
 The thin diagonal lines on the inner and outer side walls of the luminaire are to illustrate translucency. The portions in broken lines do not form part of the design.

1 Claim, 12 Drawing Sheets

(58) **Field of Classification Search**
 CPC F21S 6/00; F21S 6/002; F21V 1/00; F21V 3/00; F21V 21/02; F21V 21/06; F21W 2121/00; F21W 2131/30; B65D 17/165; G09F 21/04; G09B 23/04
 See application file for complete search history.

(56) **References Cited**

U.S. PATENT DOCUMENTS

D654,703	S	*	2/2012	LeMay	D6/300
D712,591	S	*	9/2014	Sannella	D26/141
D747,109	S	*	1/2016	Shay-Puetzer	D6/300
D800,368	S	*	10/2017	Czech	D26/76
D802,819	S	*	11/2017	Czech	D26/76

* cited by examiner

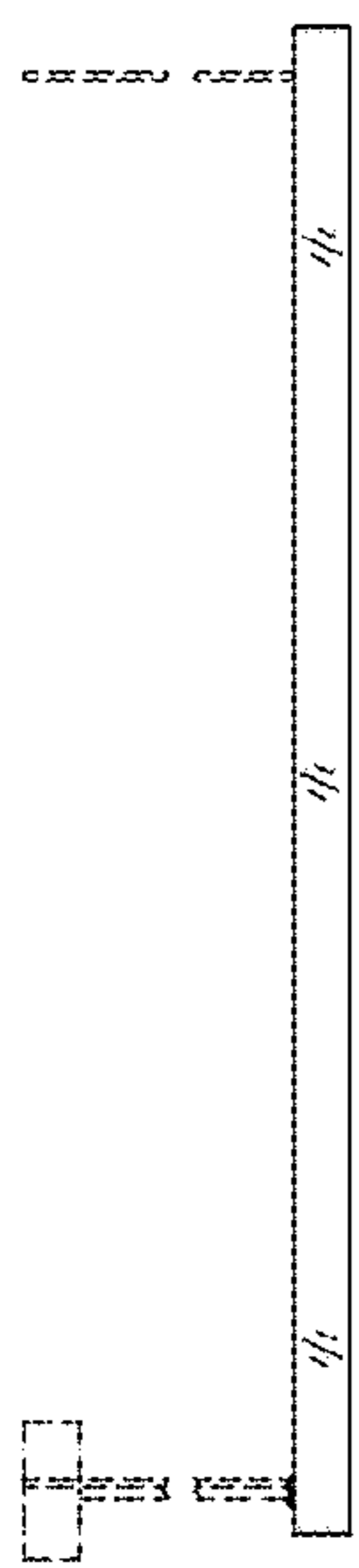

FIG. 1

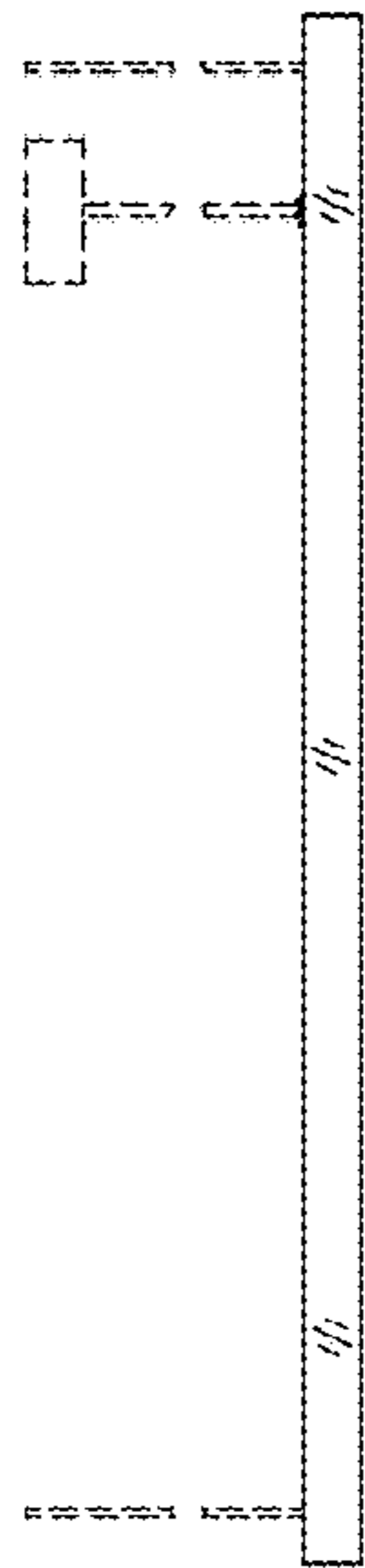

FIG. 2

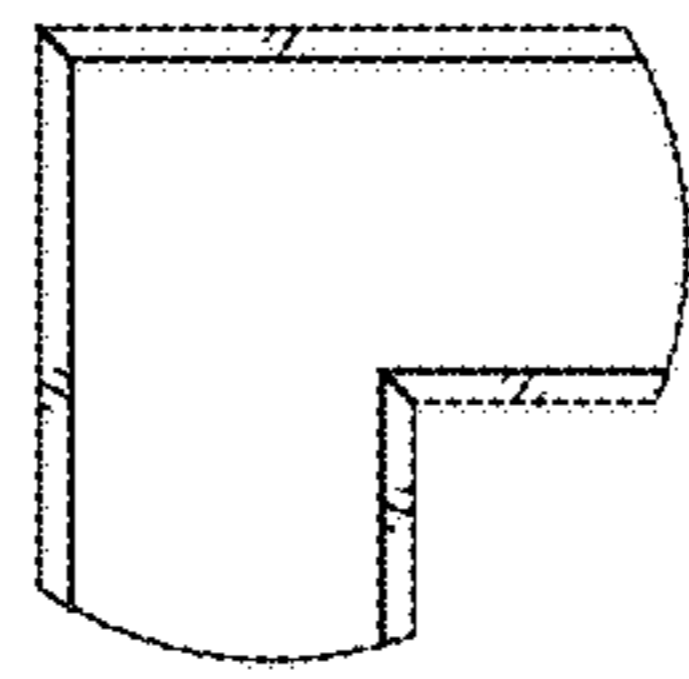

FIG. 6

FIG. 6

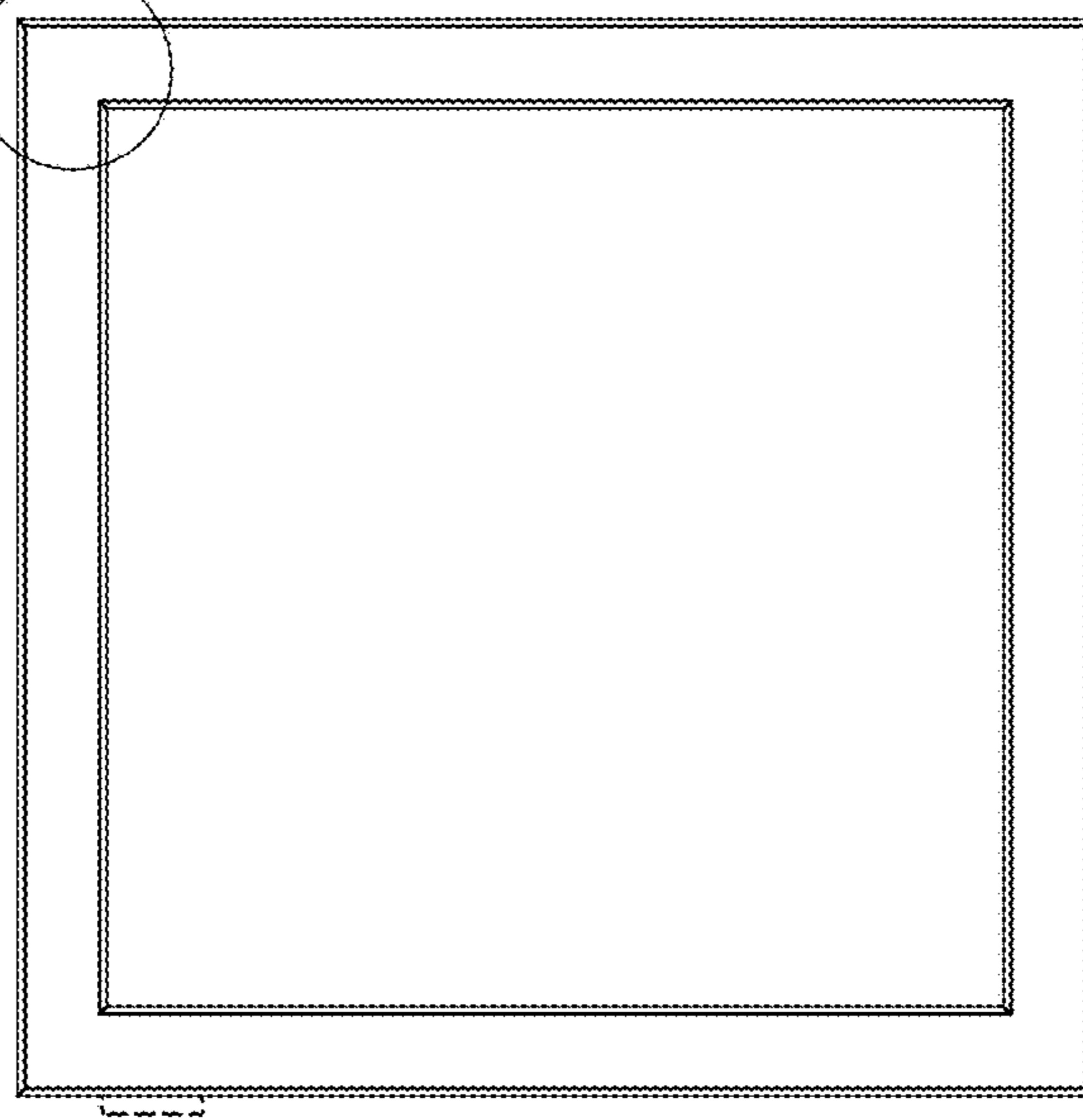

FIG. 3

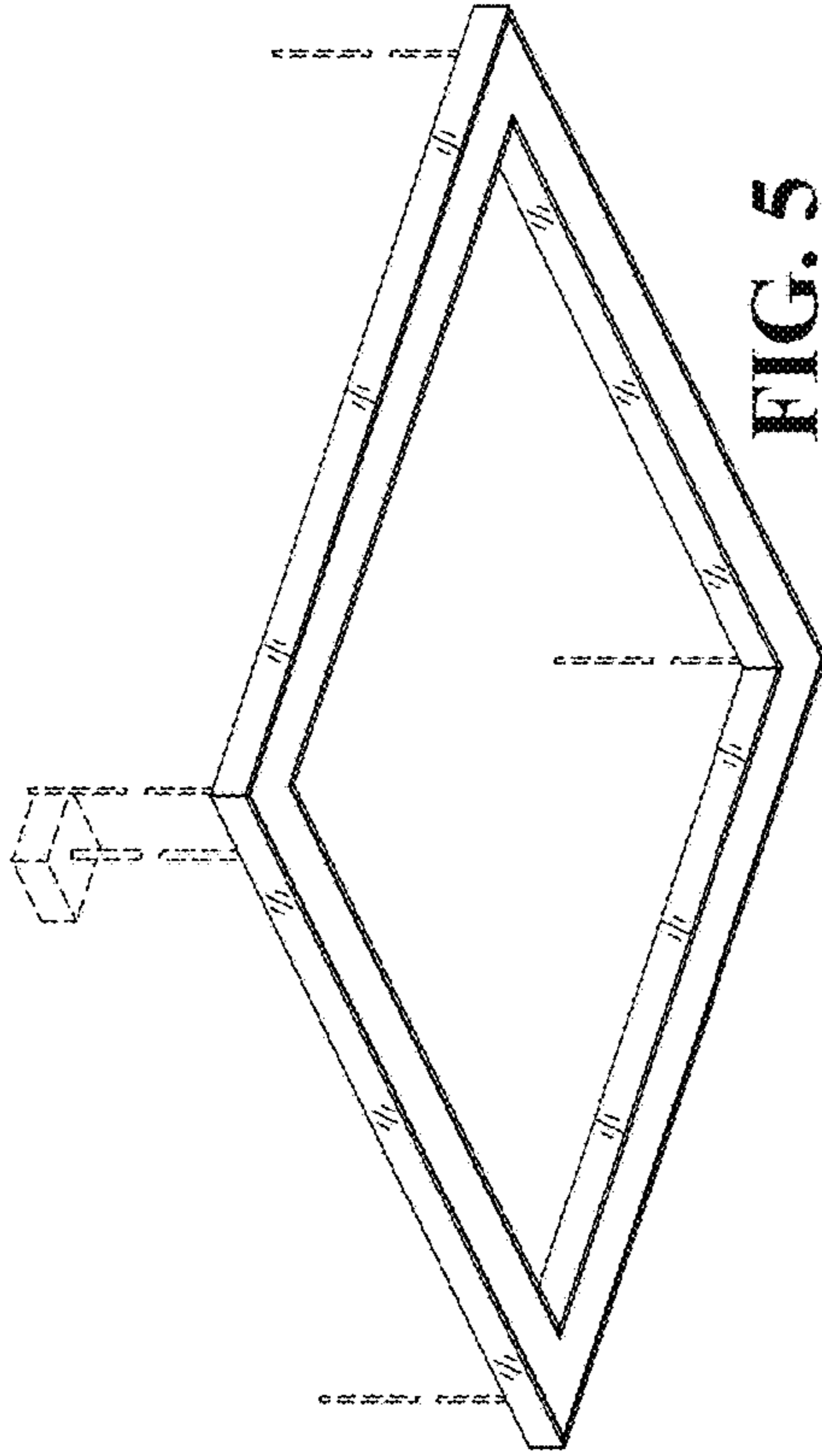

FIG. 5

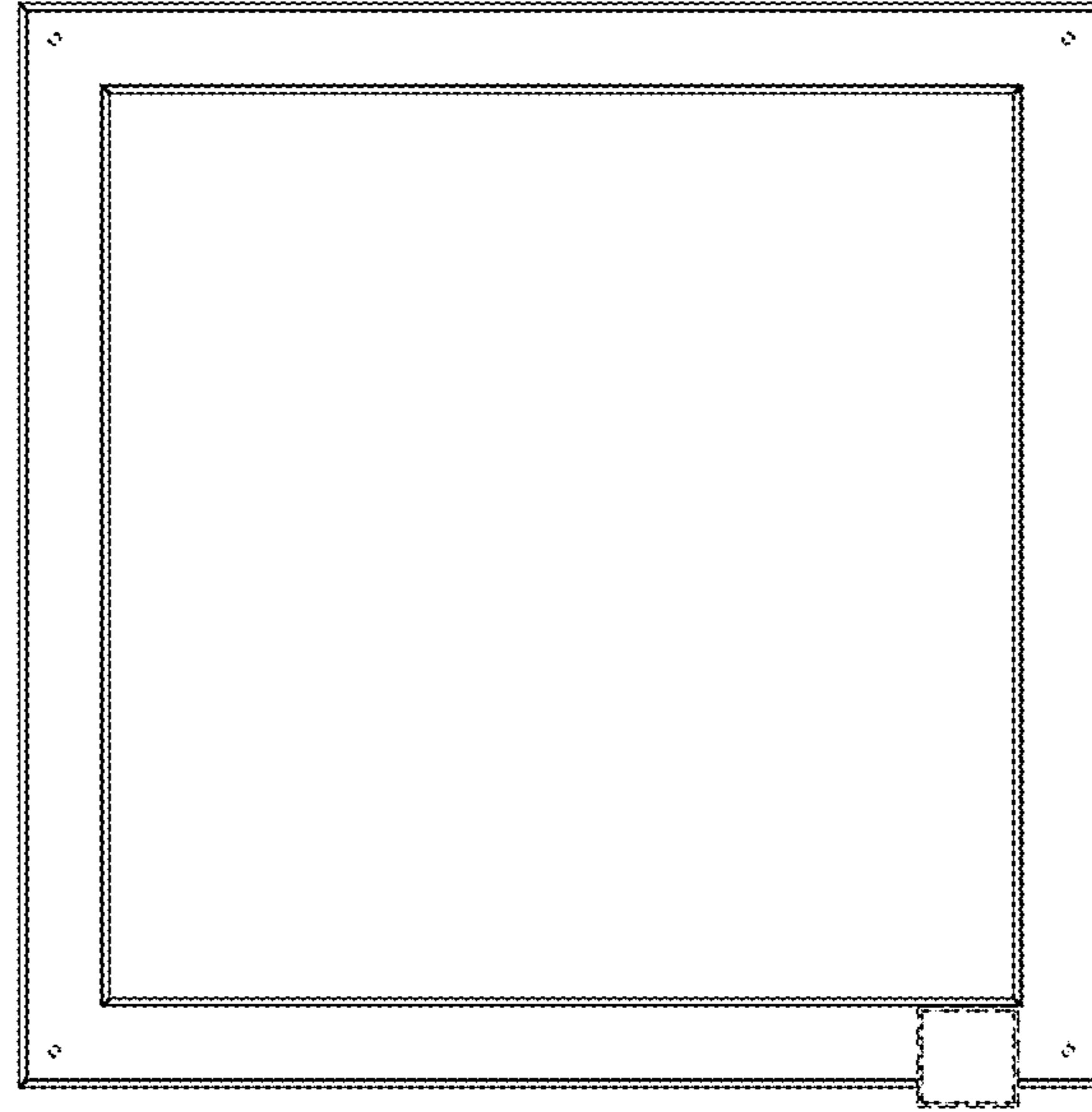

FIG. 4

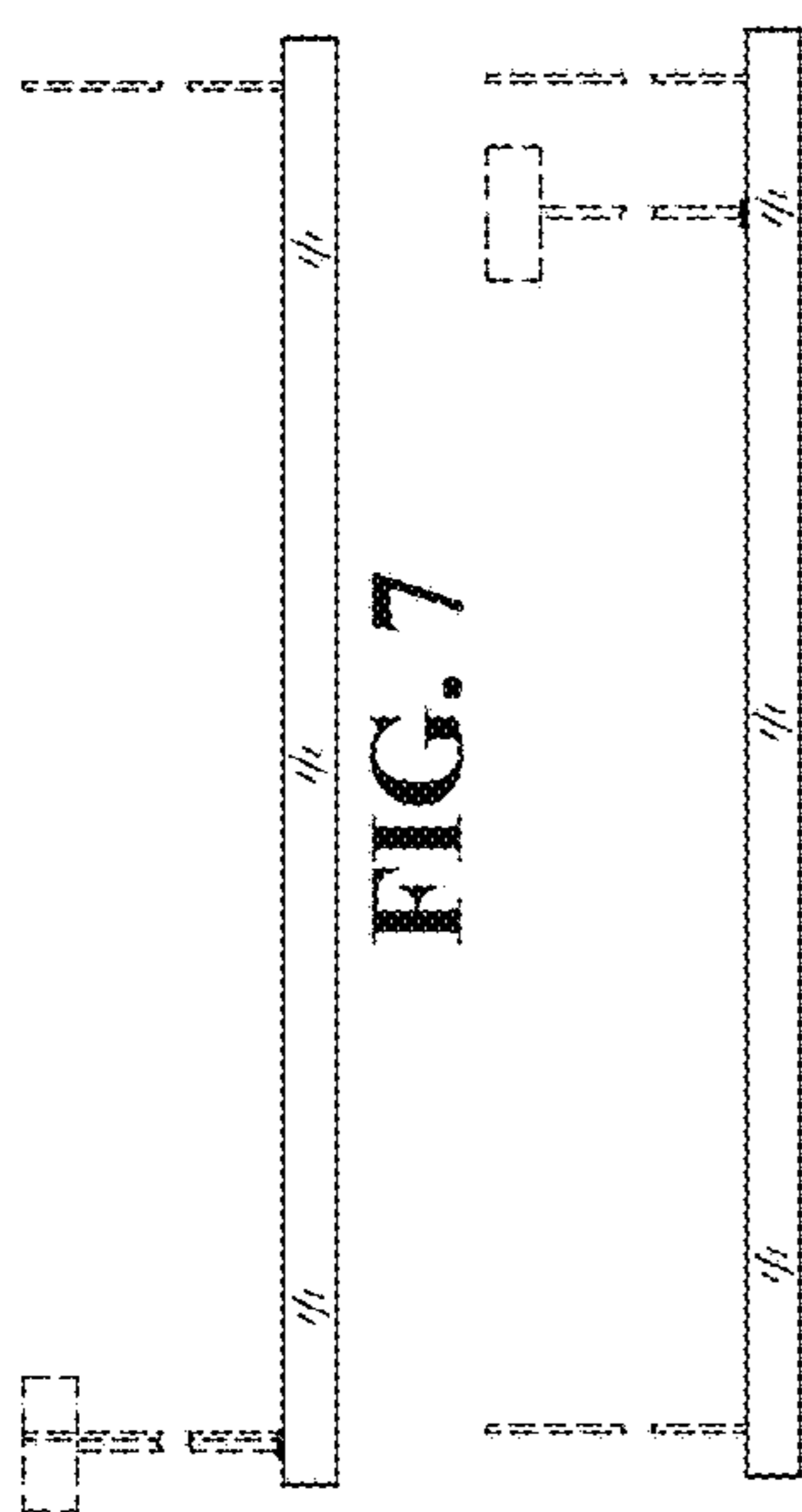

FIG. 7

FIG. 8

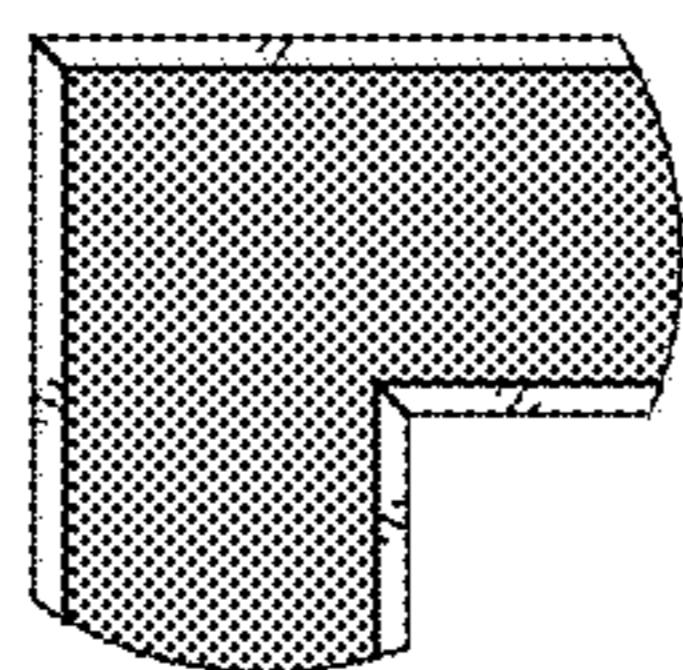

FIG. 12

FIG. 12

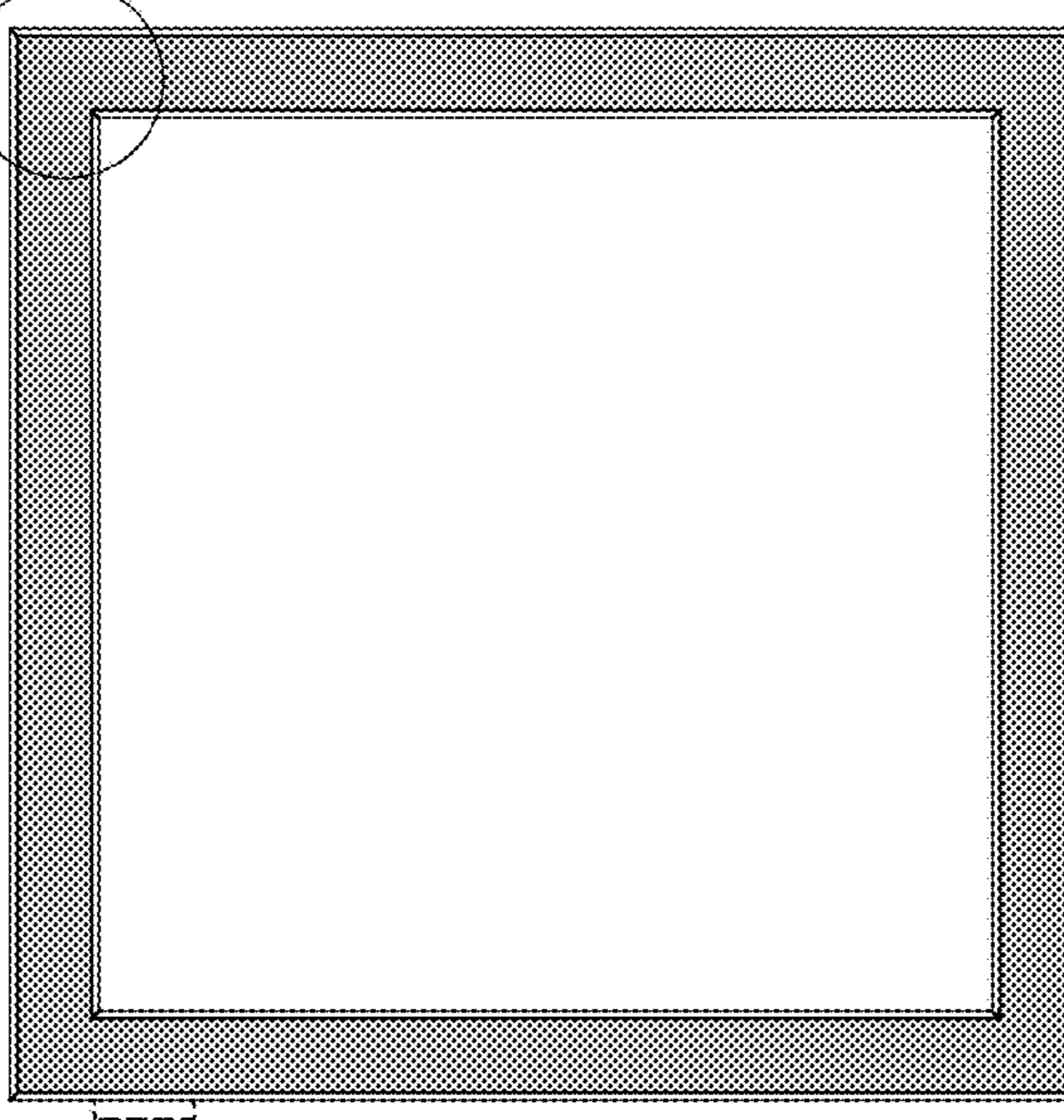

FIG. 9

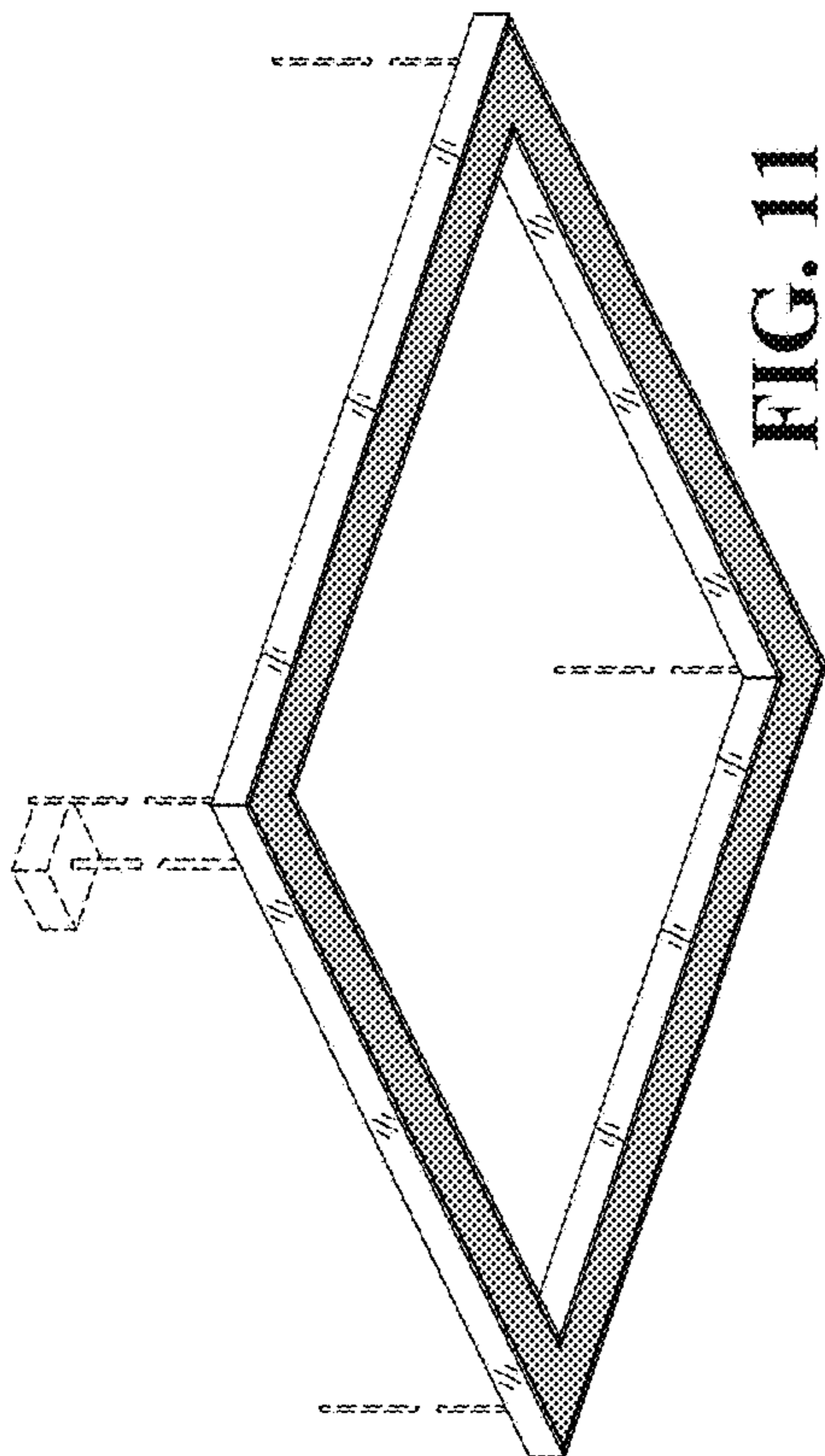

FIG. 11

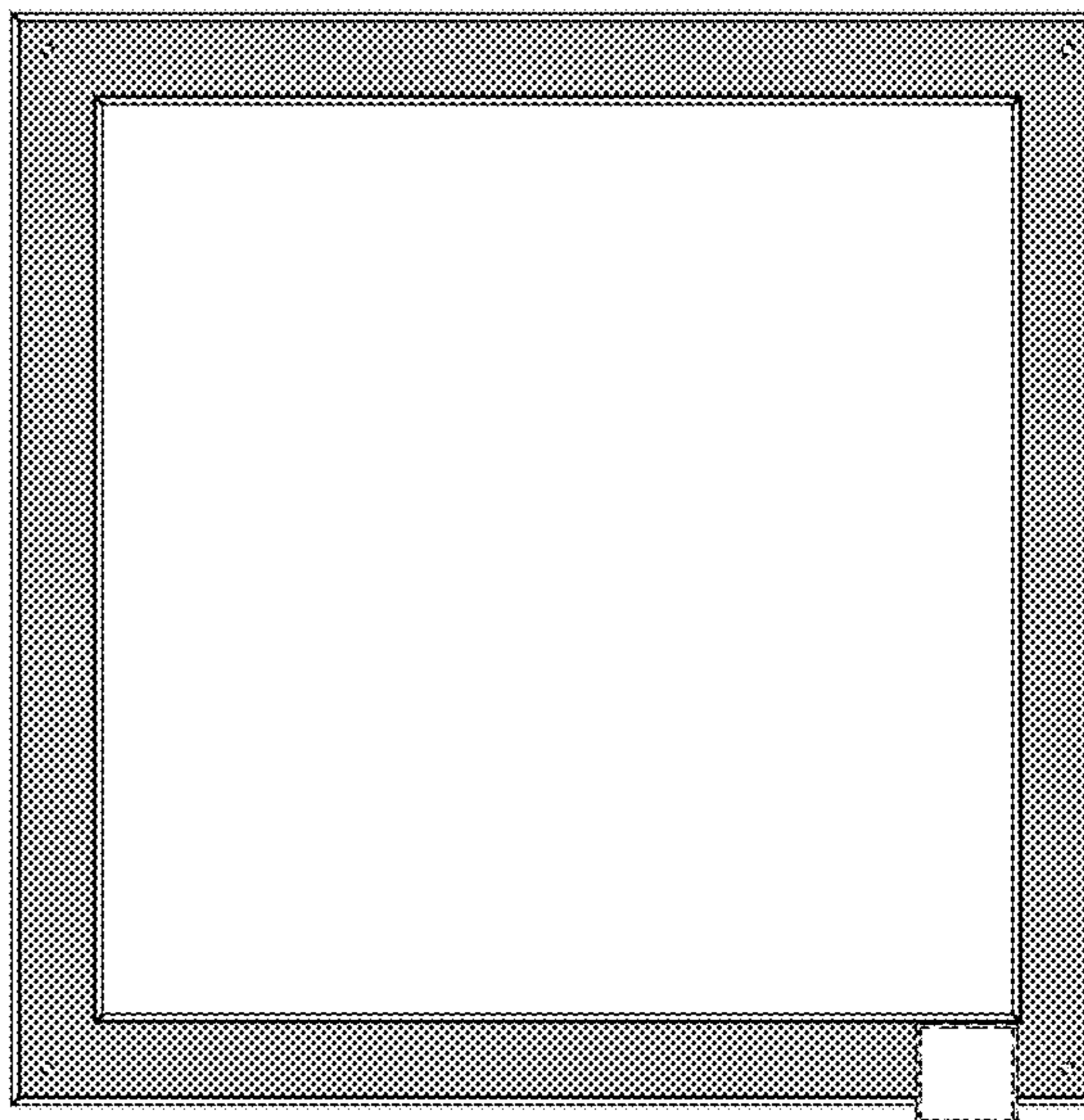

FIG. 10

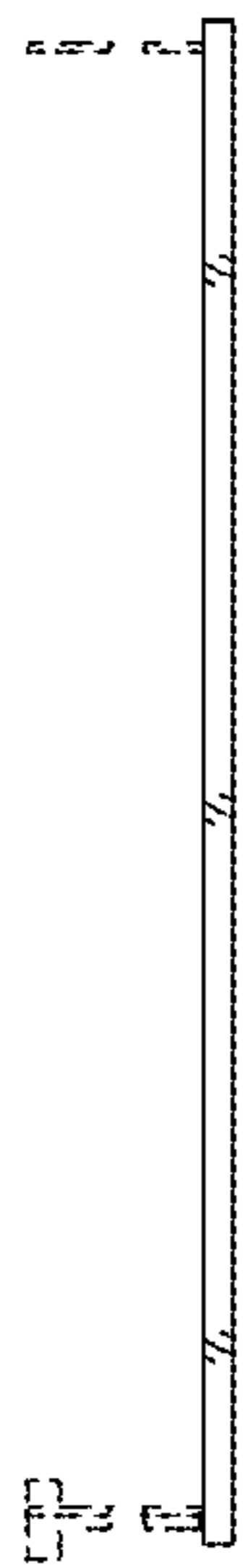

FIG. 13

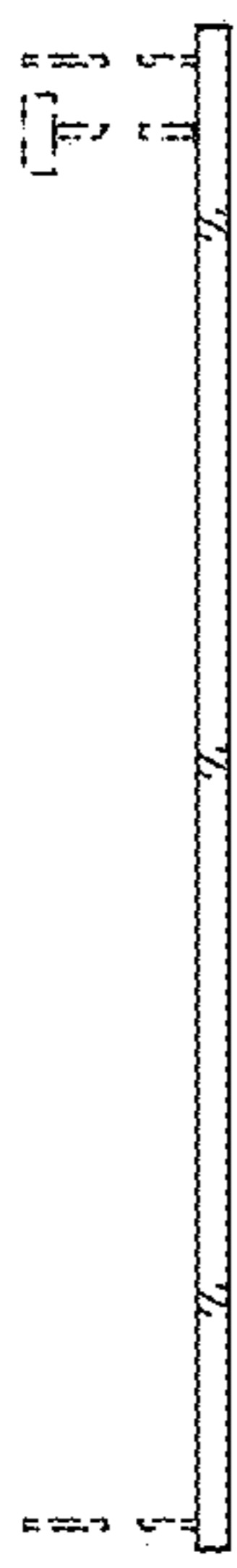

FIG. 14

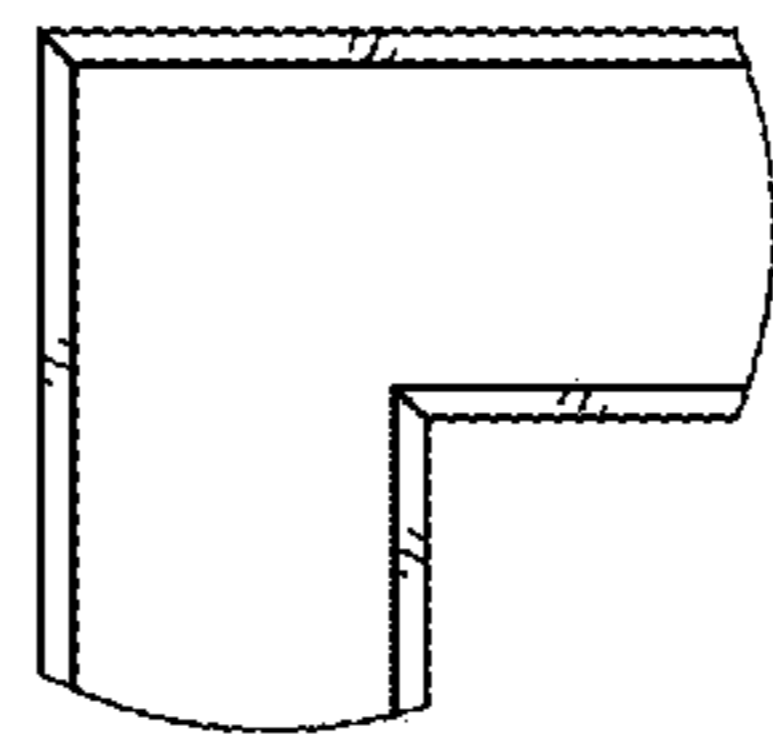

FIG. 18

FIG. 18

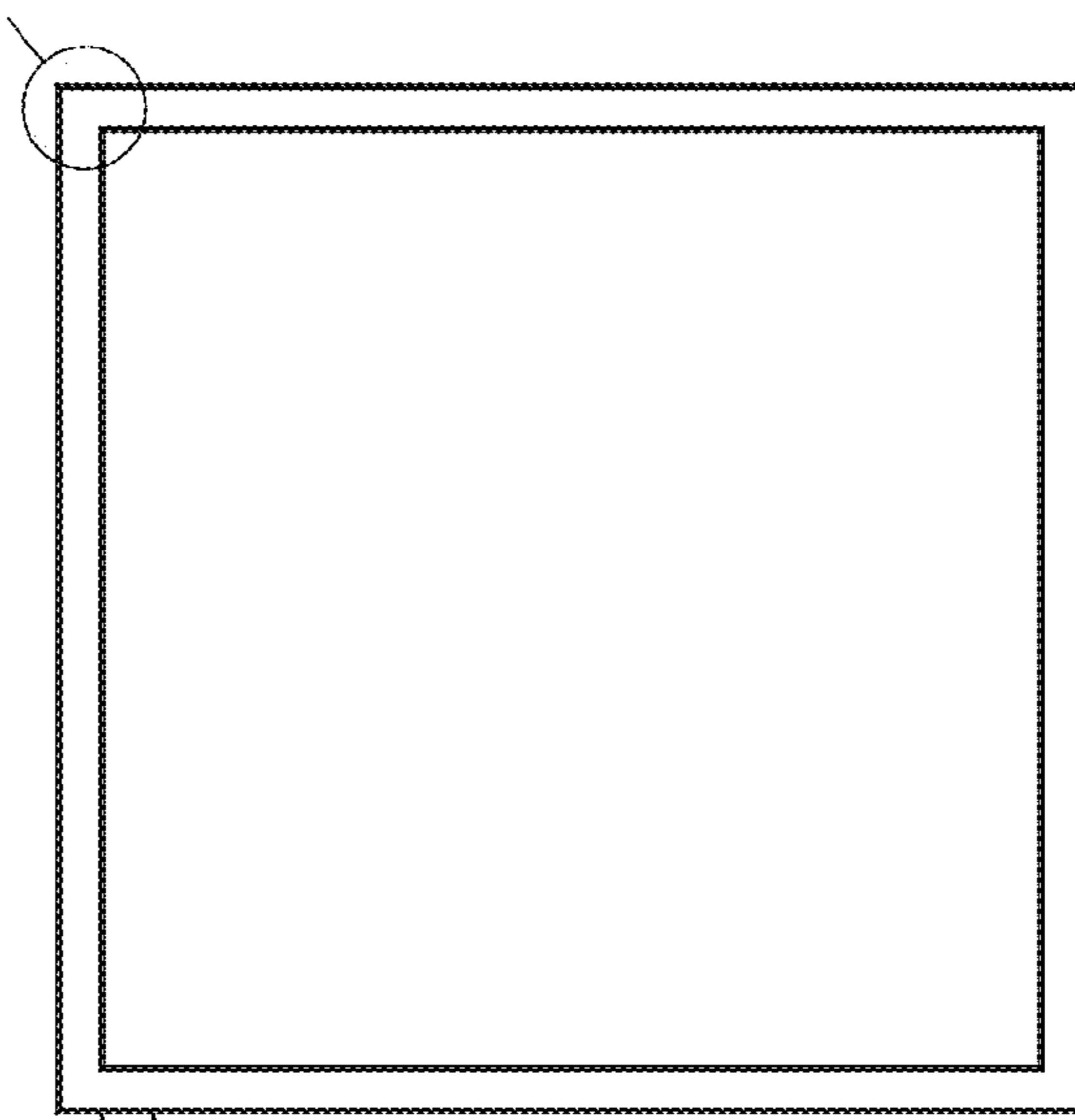

FIG. 15

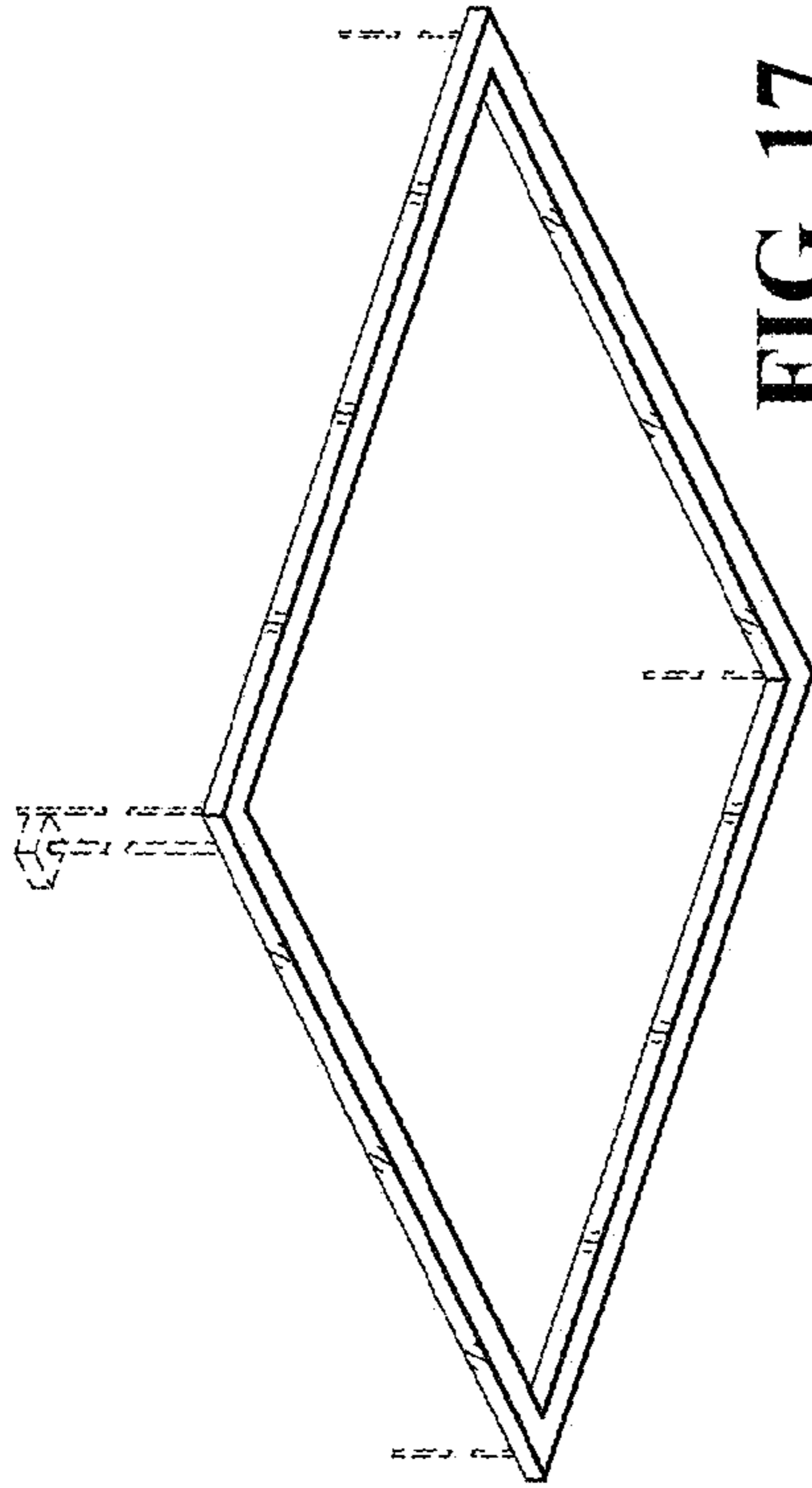

FIG. 17

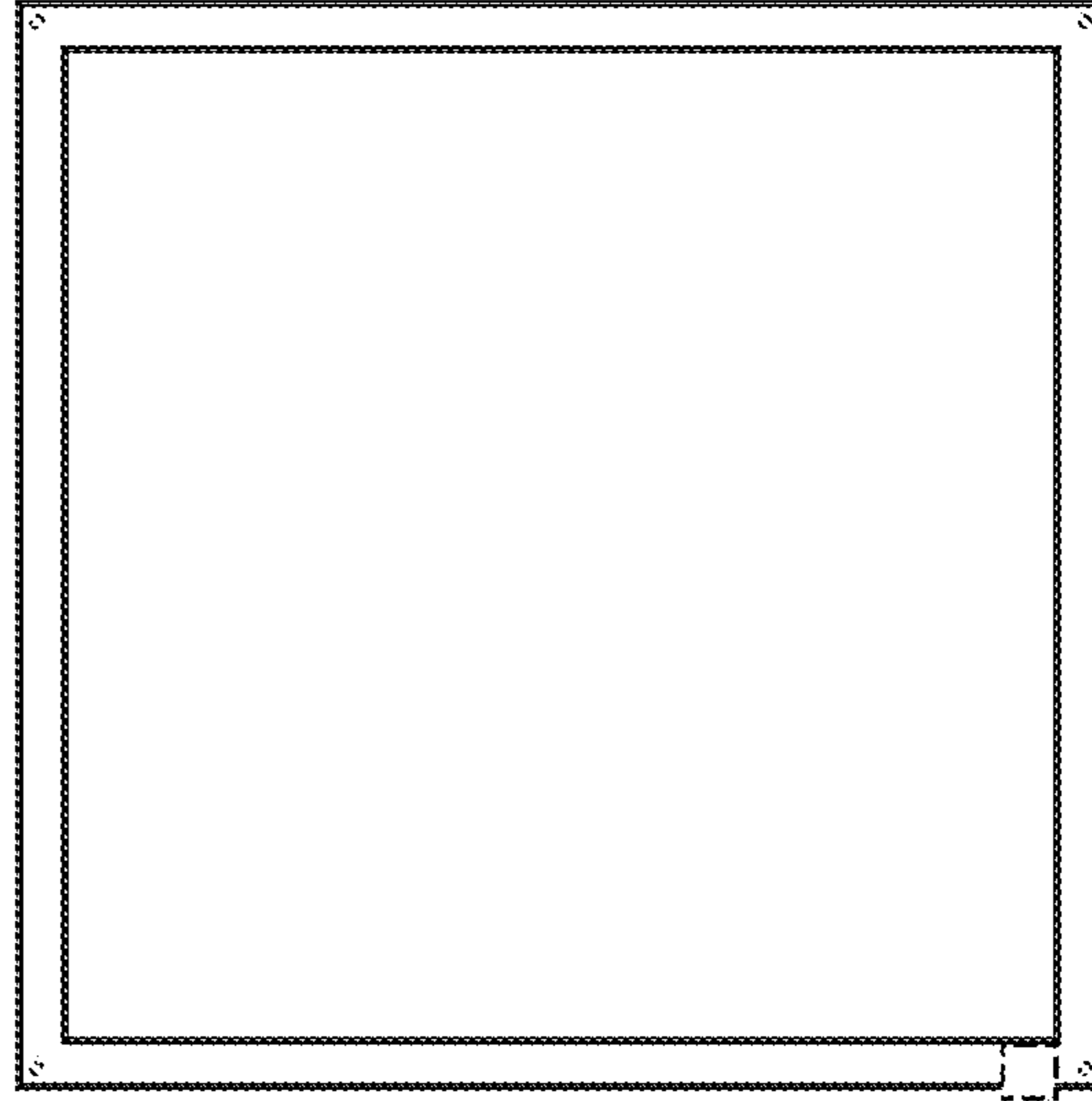

FIG. 16

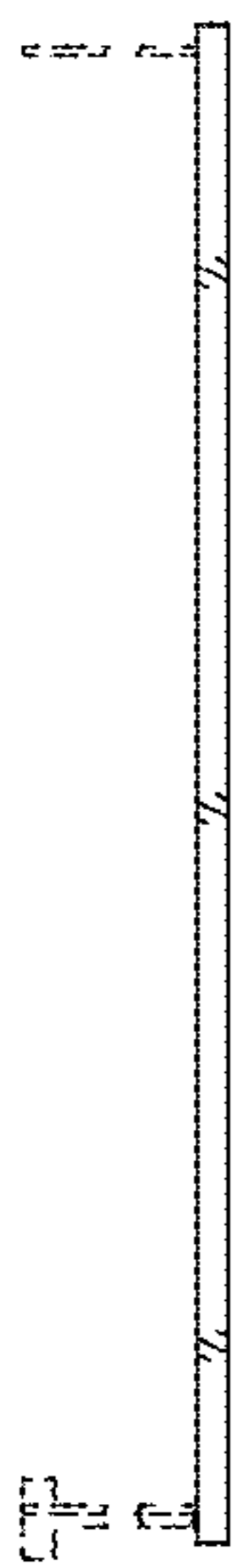

FIG. 19



FIG. 20

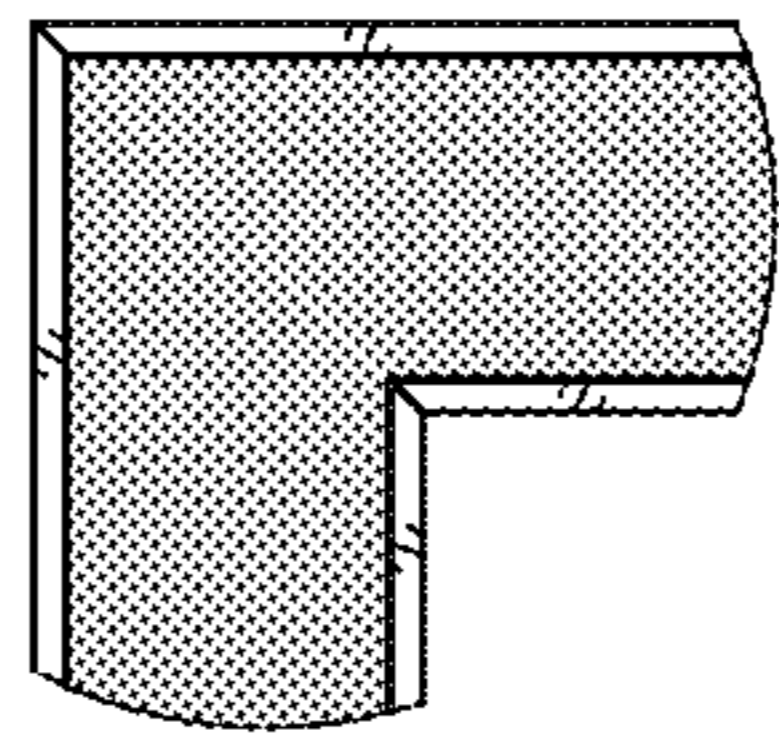

FIG. 24

FIG. 24

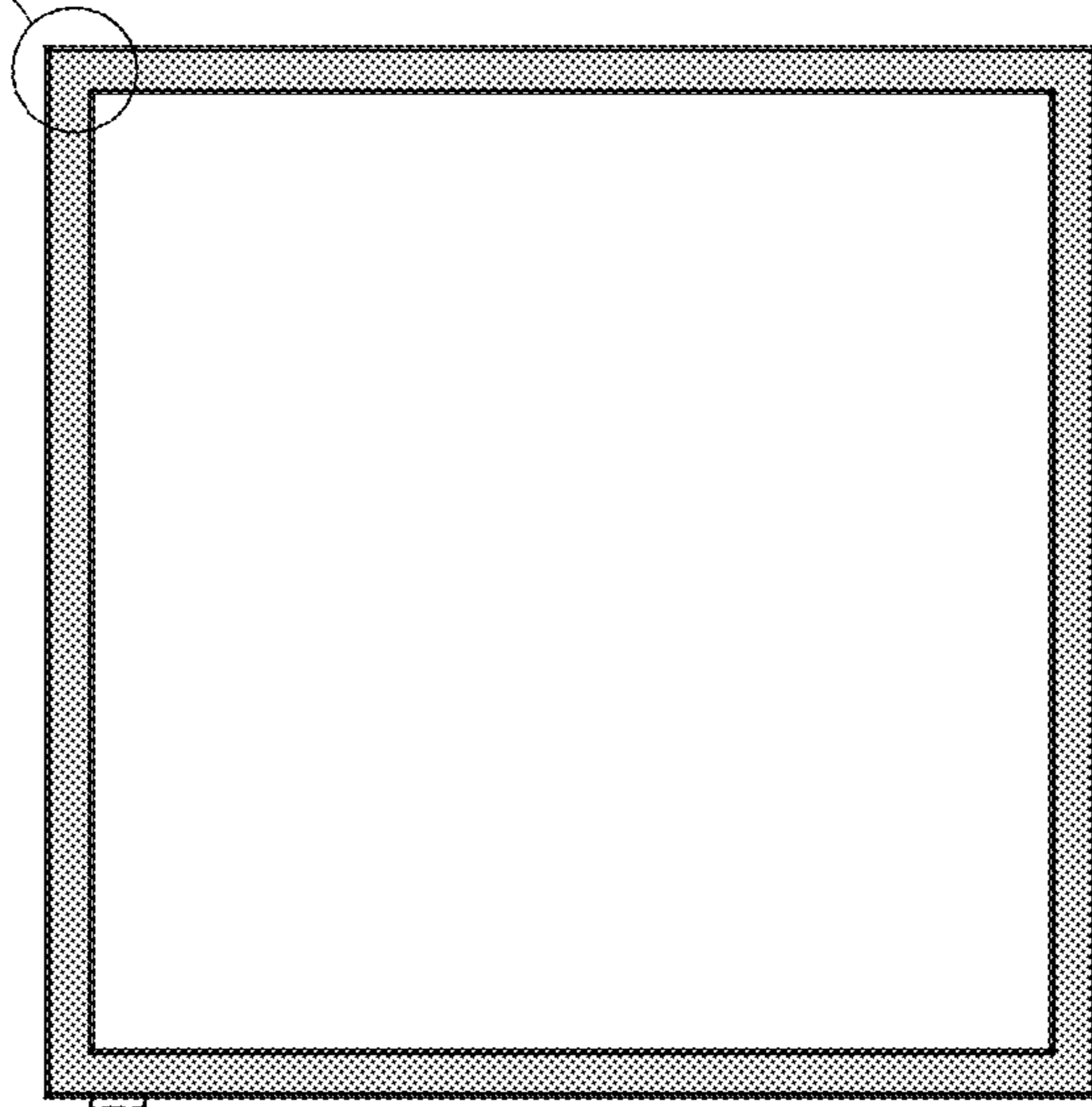

FIG. 21

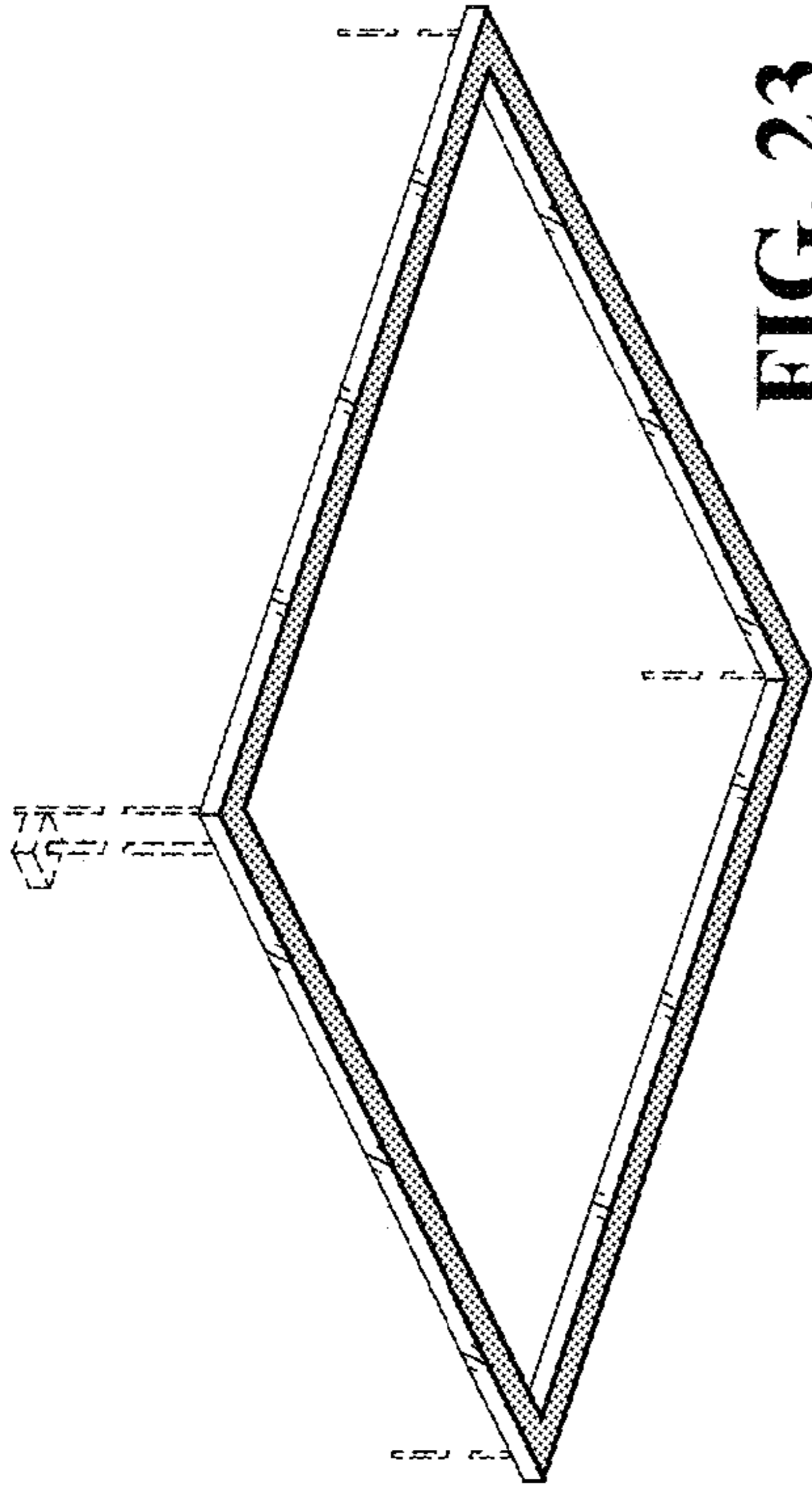

FIG. 23

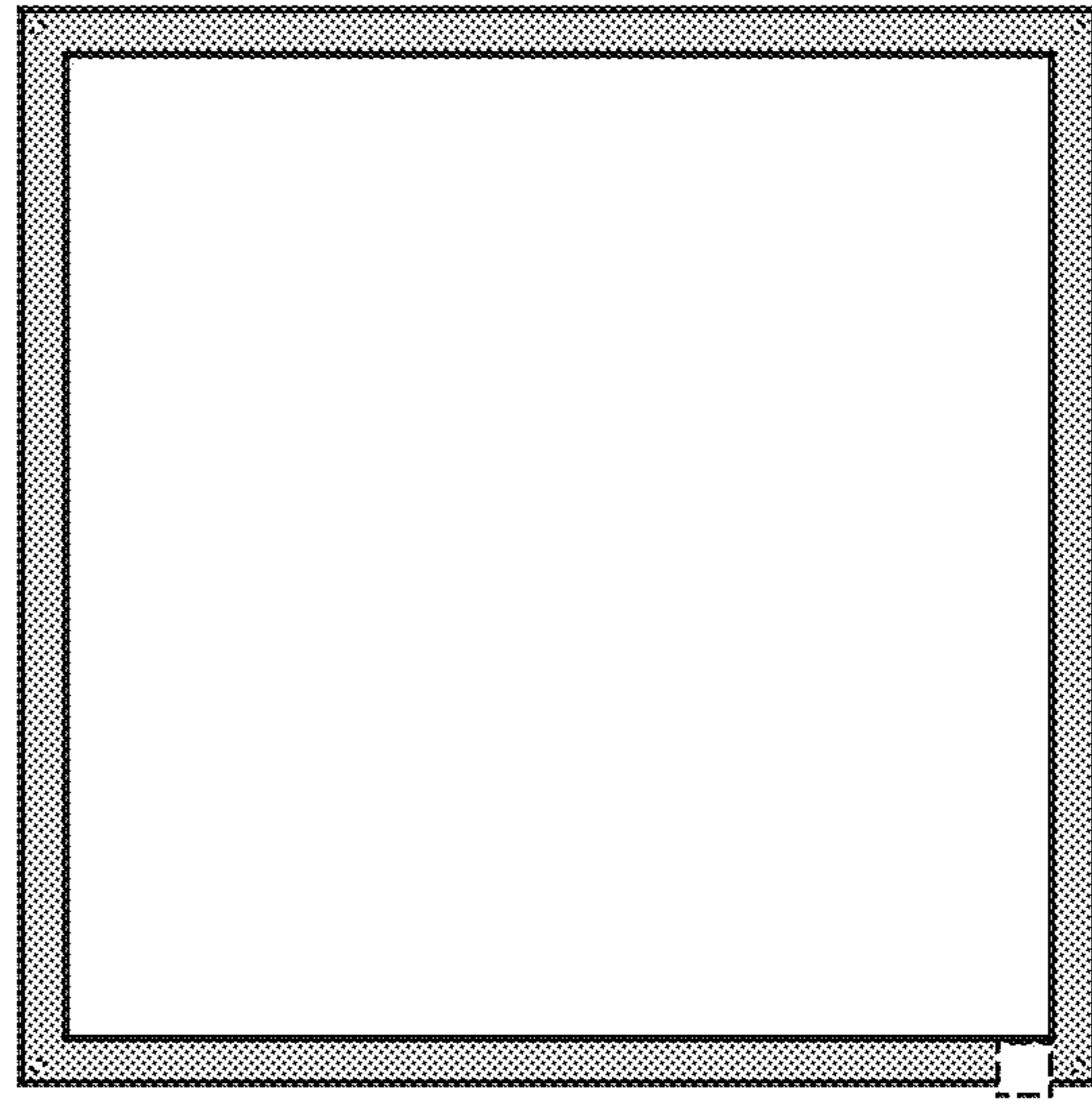

FIG. 22

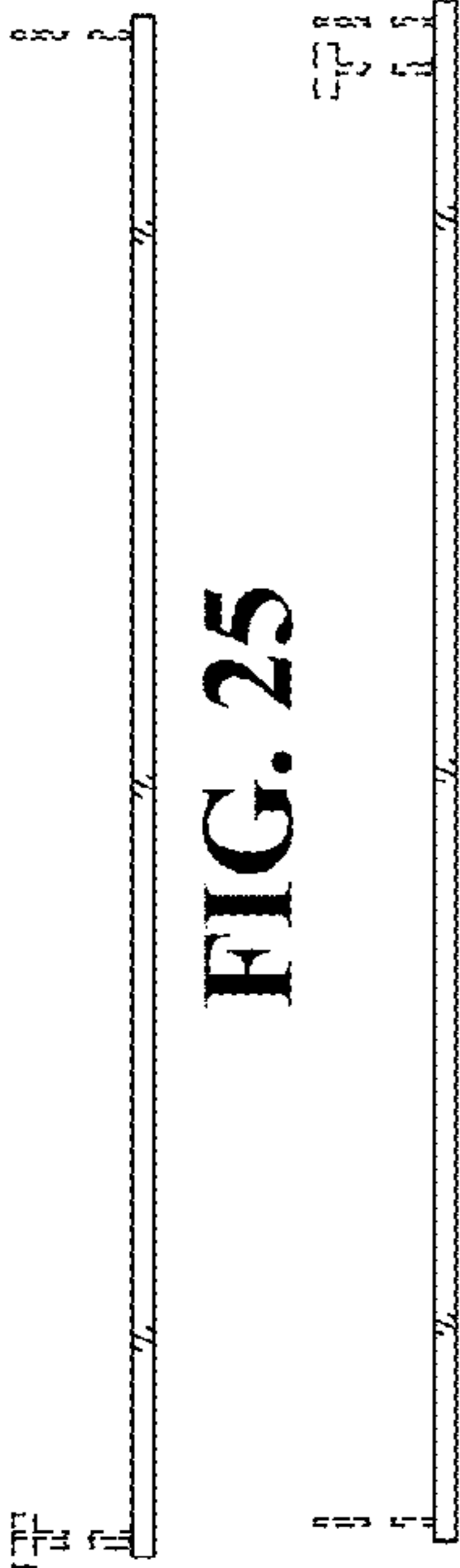

FIG. 25

FIG. 26

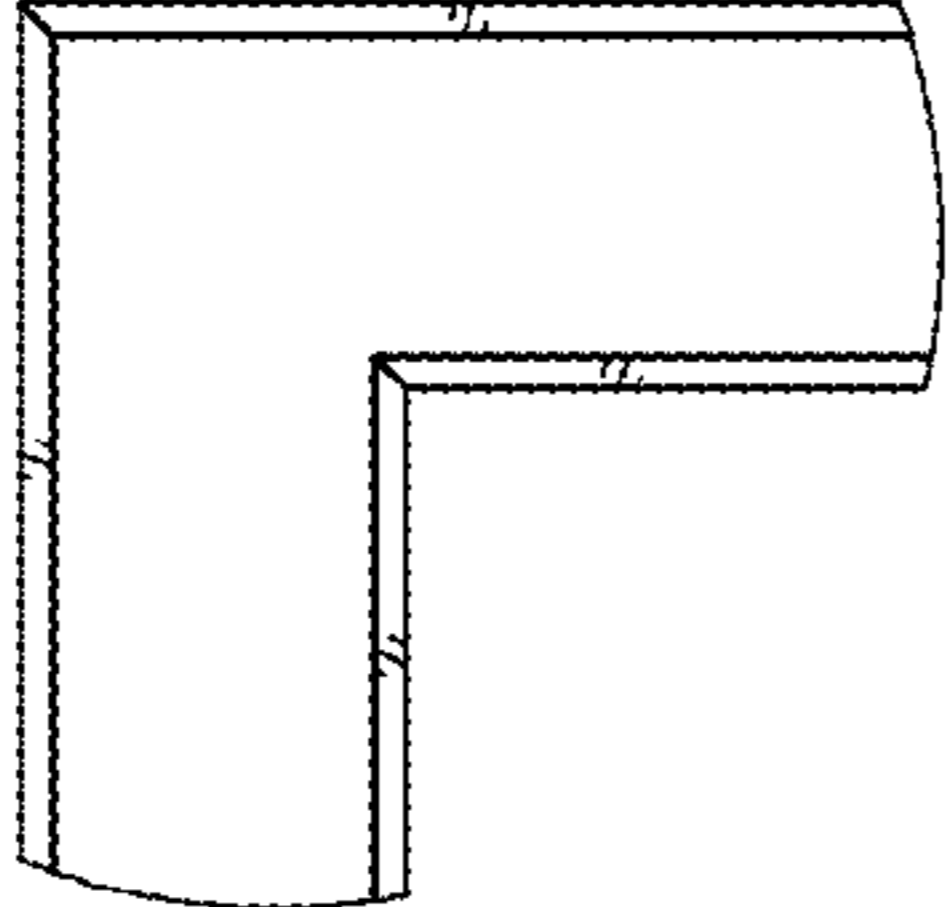

FIG. 30

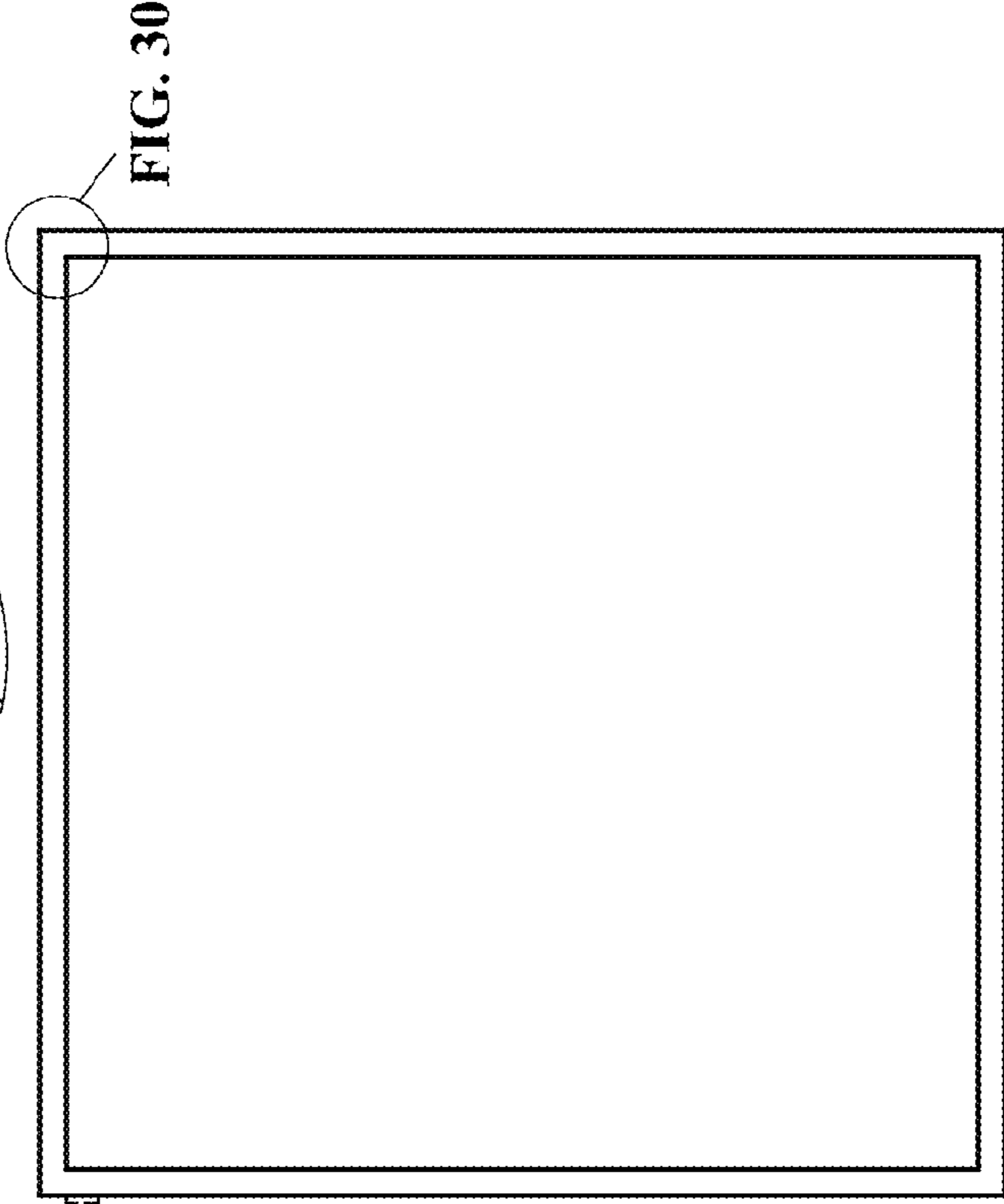

FIG. 30

FIG. 27

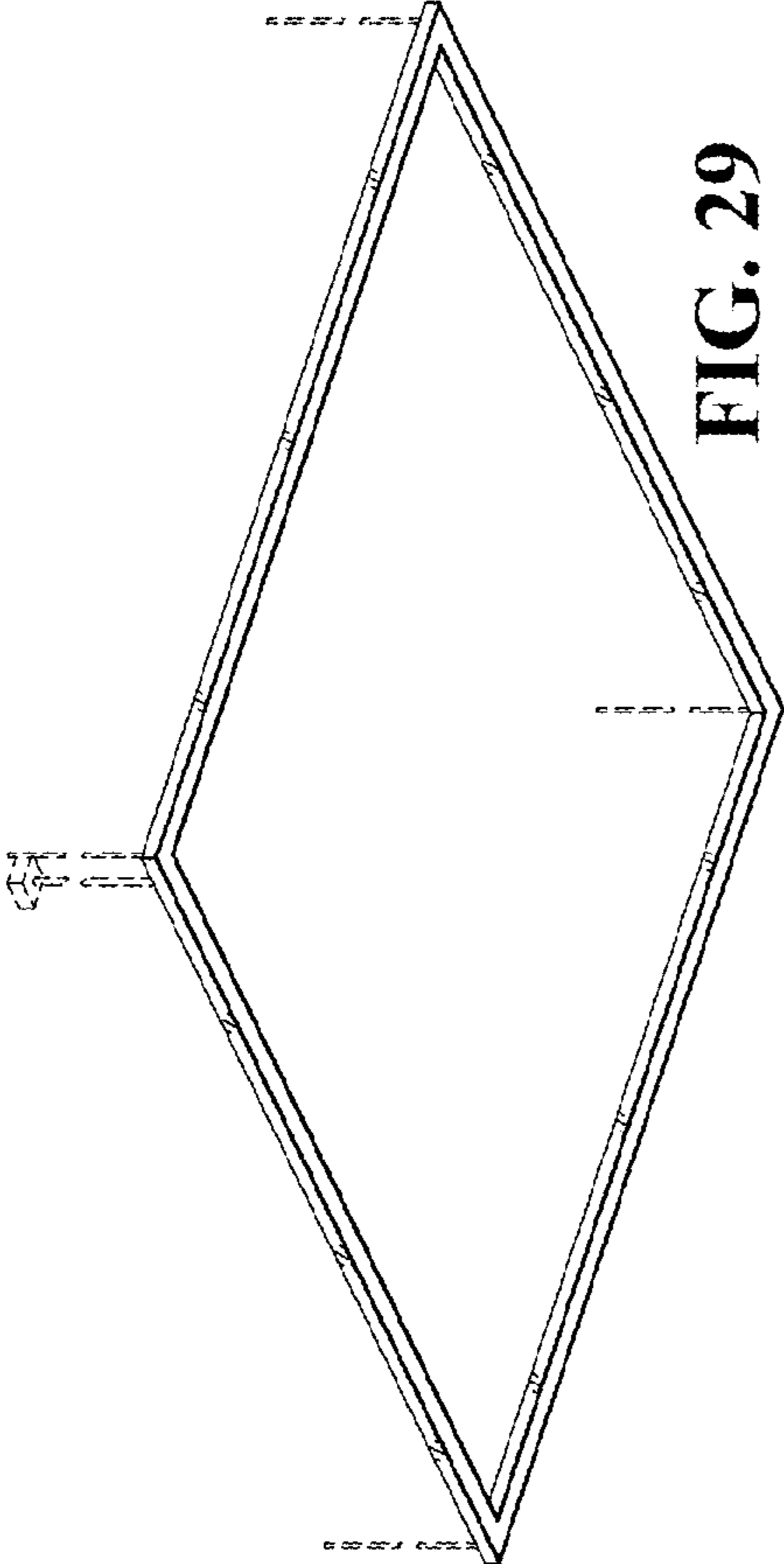

FIG. 29

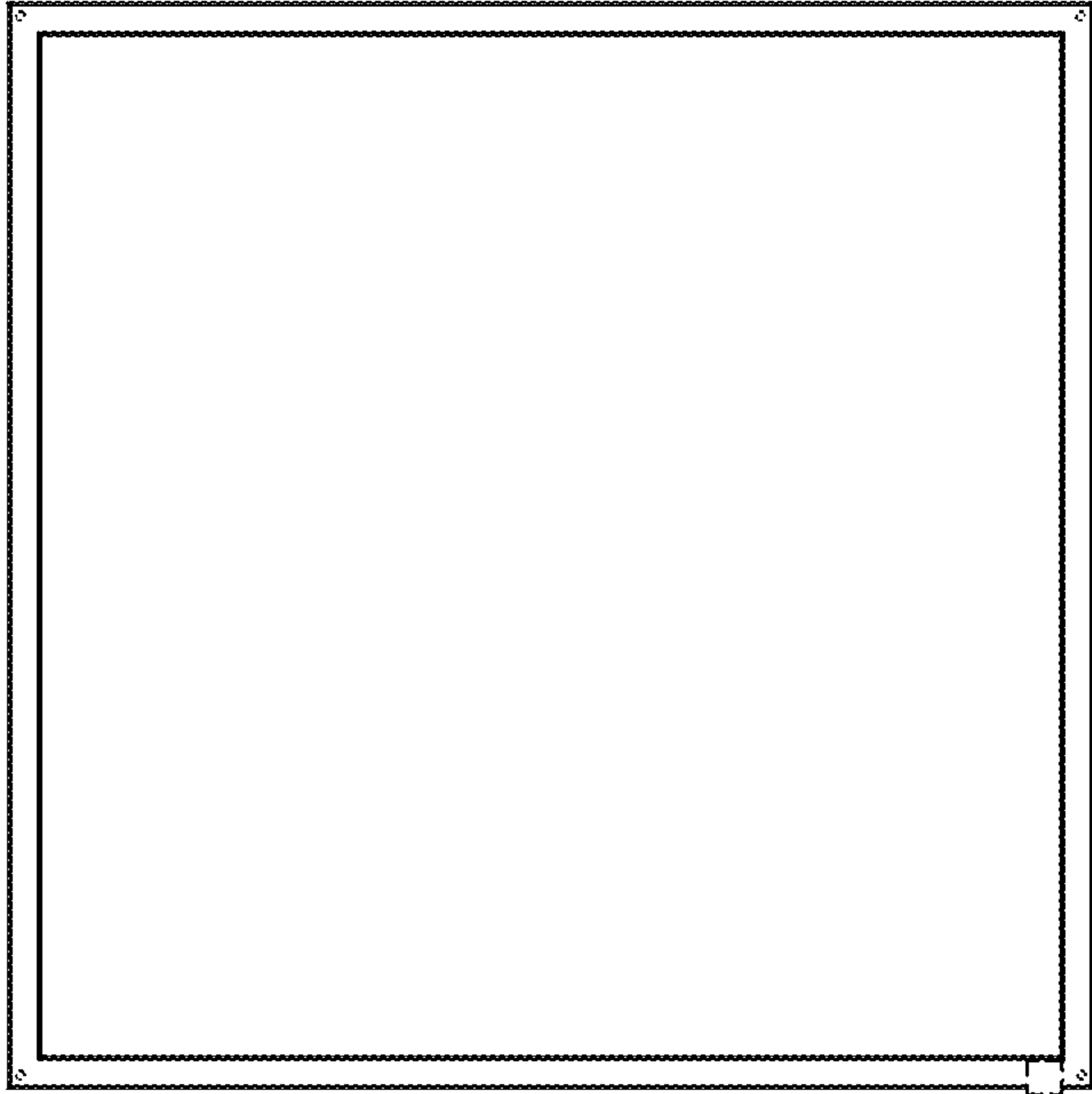

FIG. 28

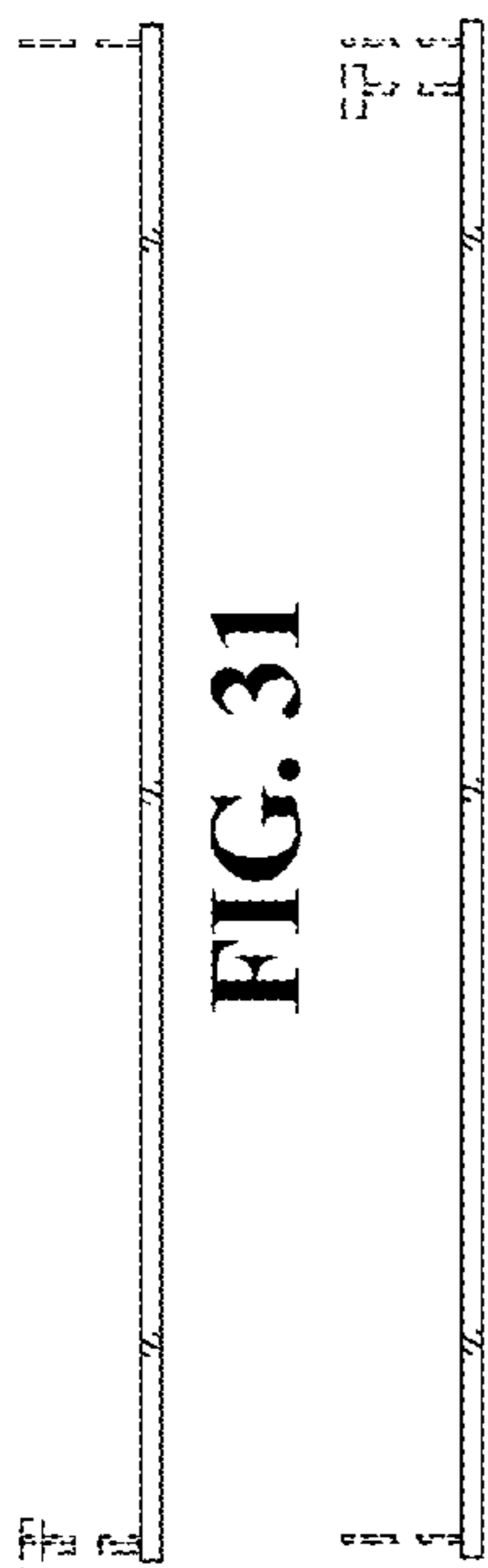

FIG. 31

FIG. 32

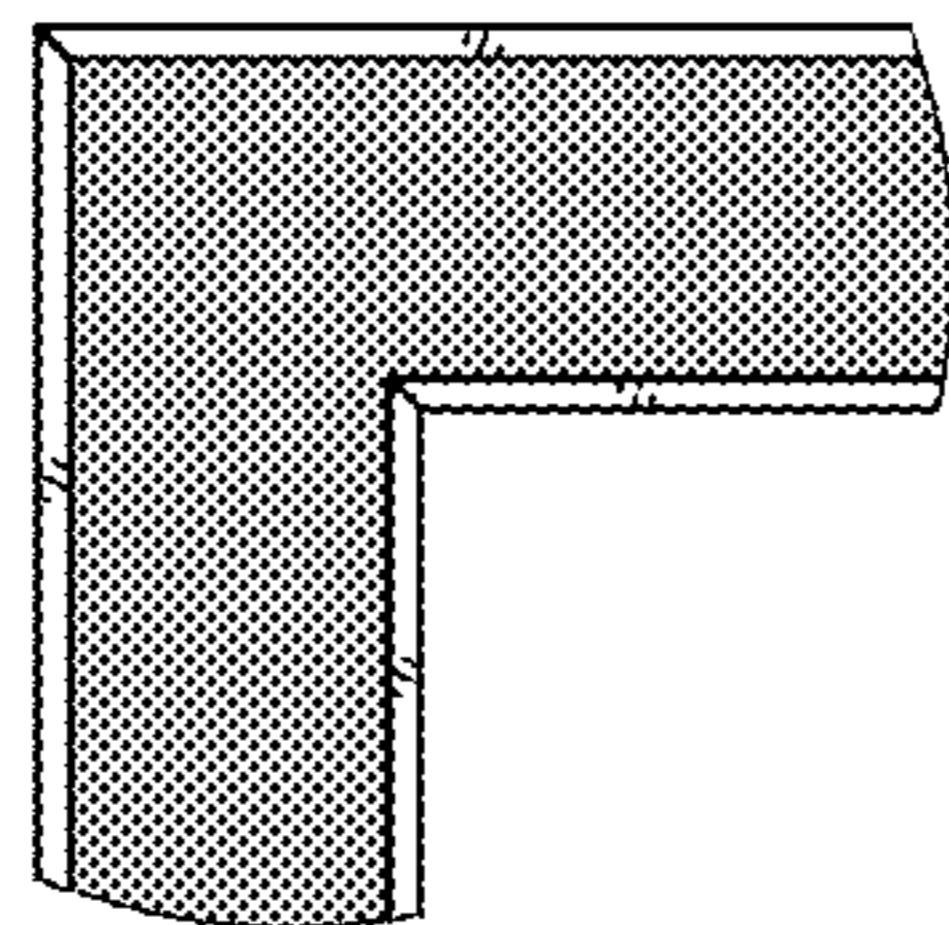

FIG. 36

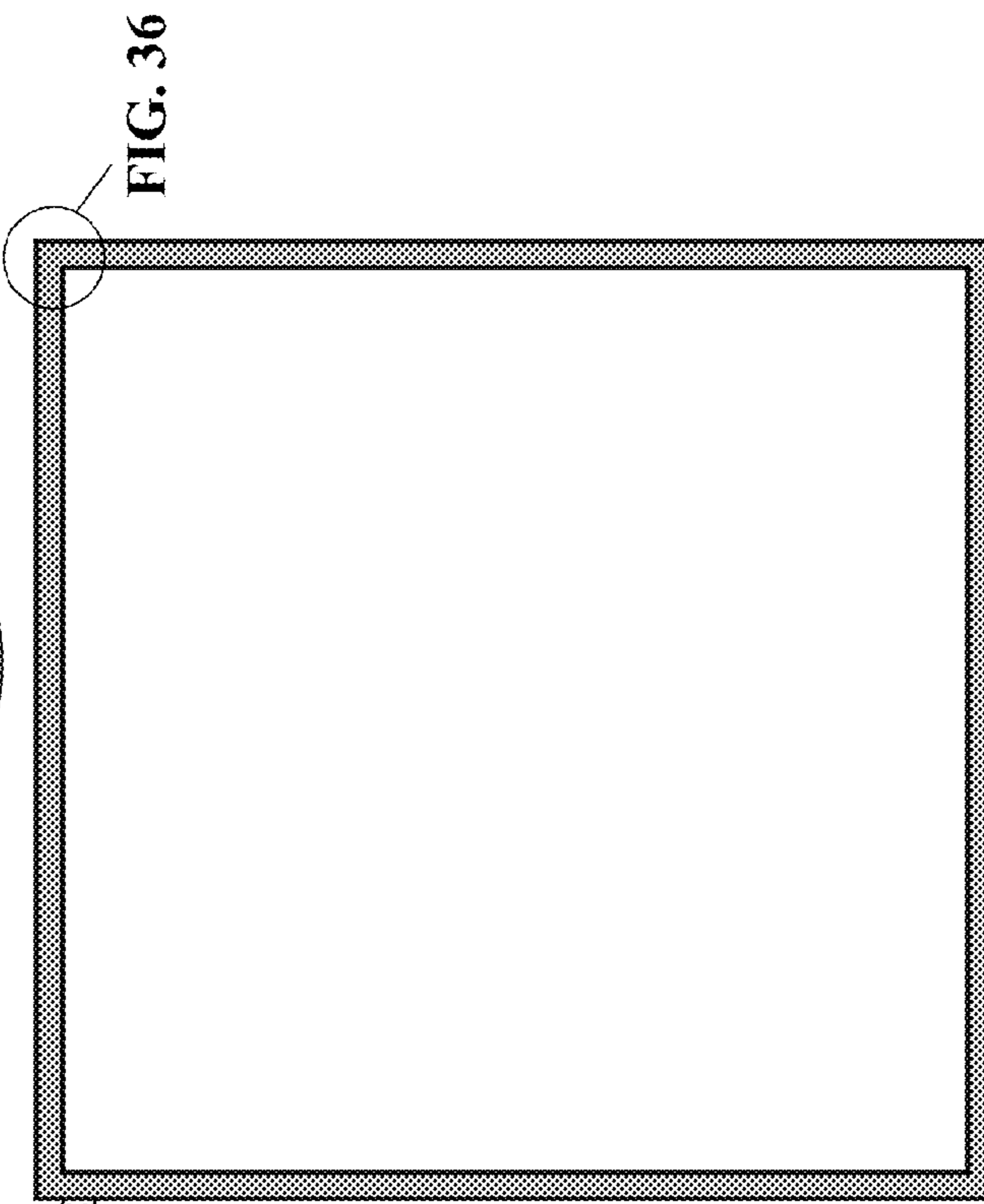

FIG. 36

FIG. 33

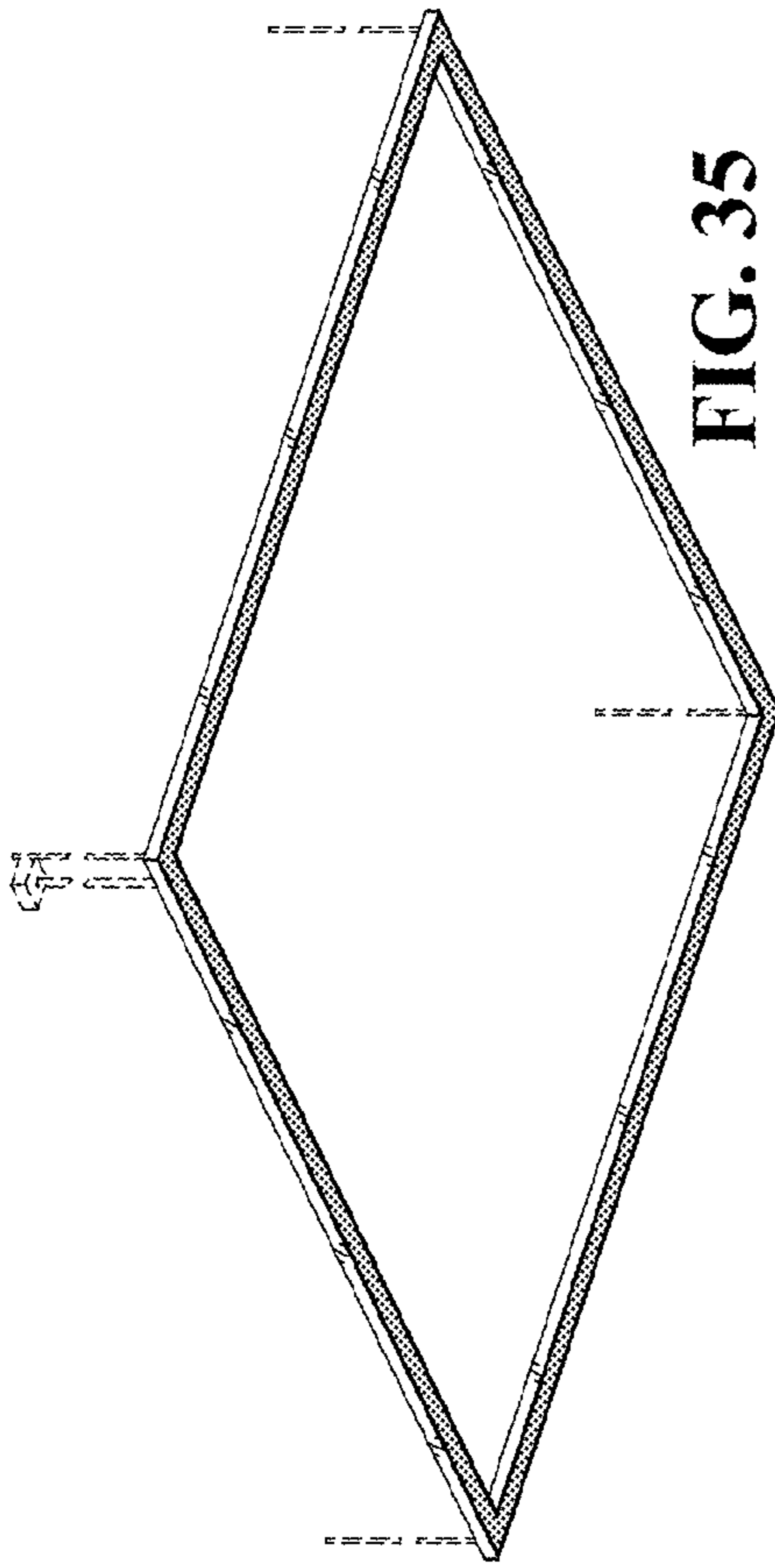

FIG. 35

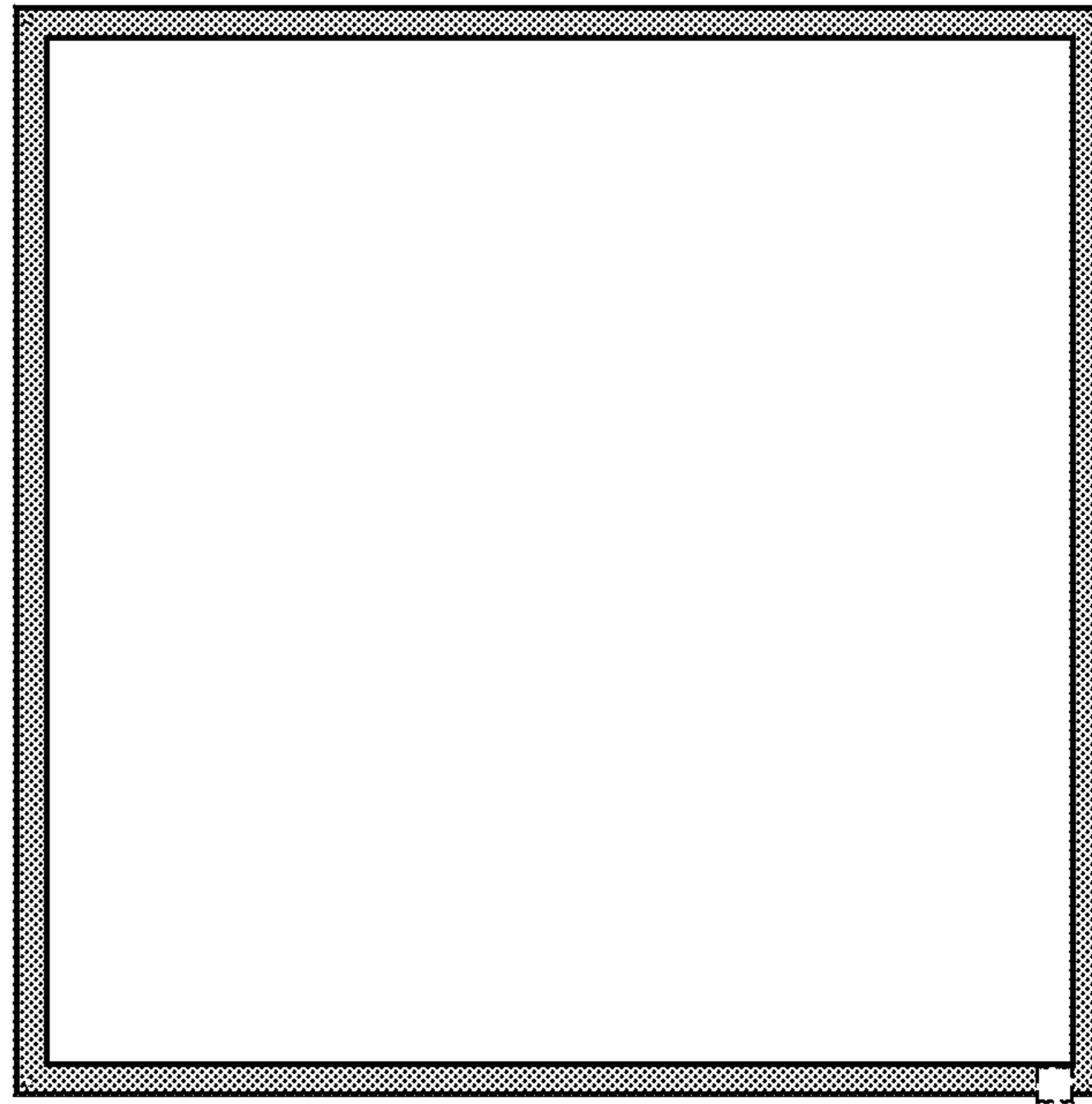

FIG. 34

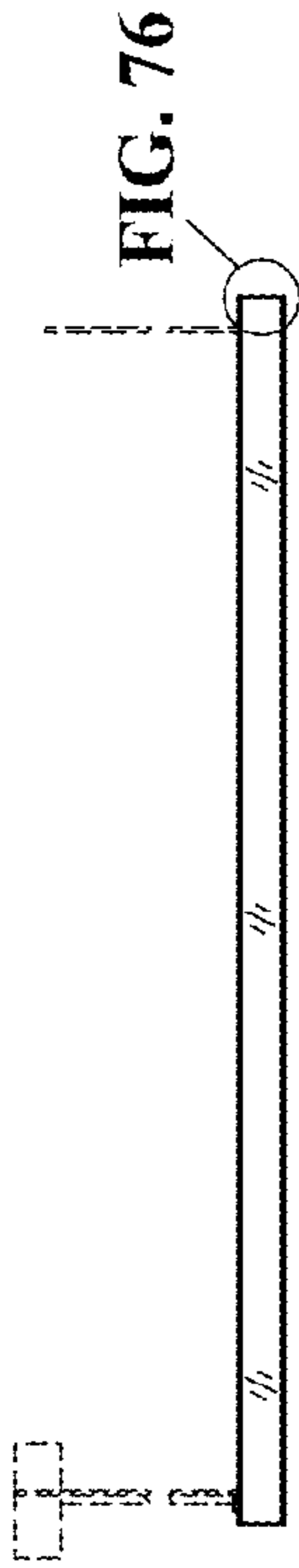

FIG. 37

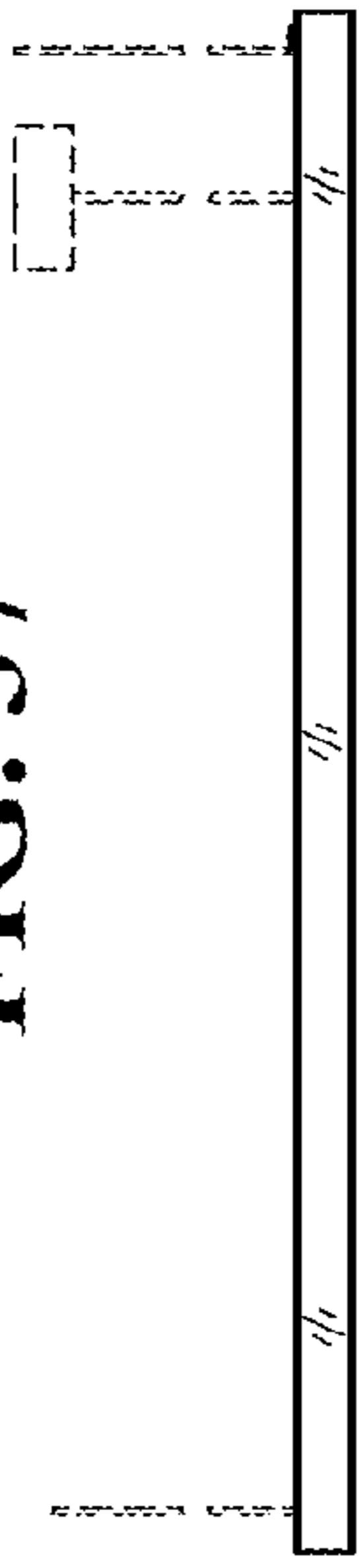

FIG. 38

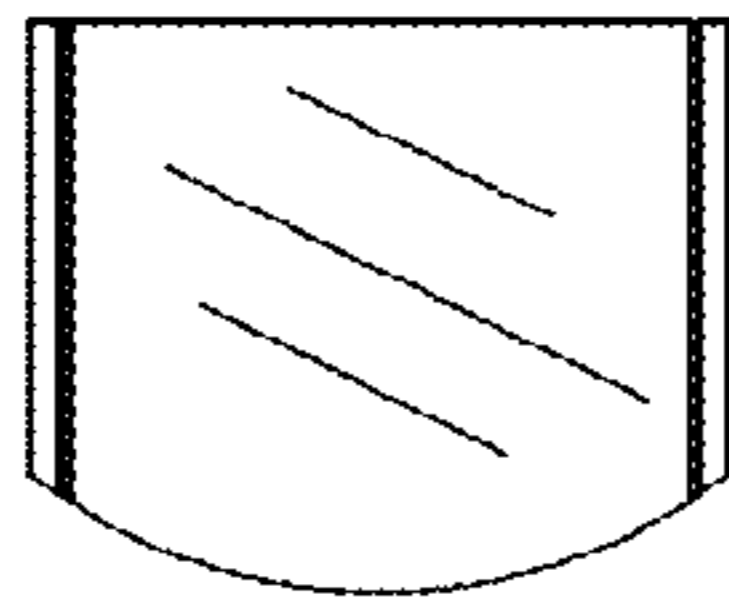

FIG. 42

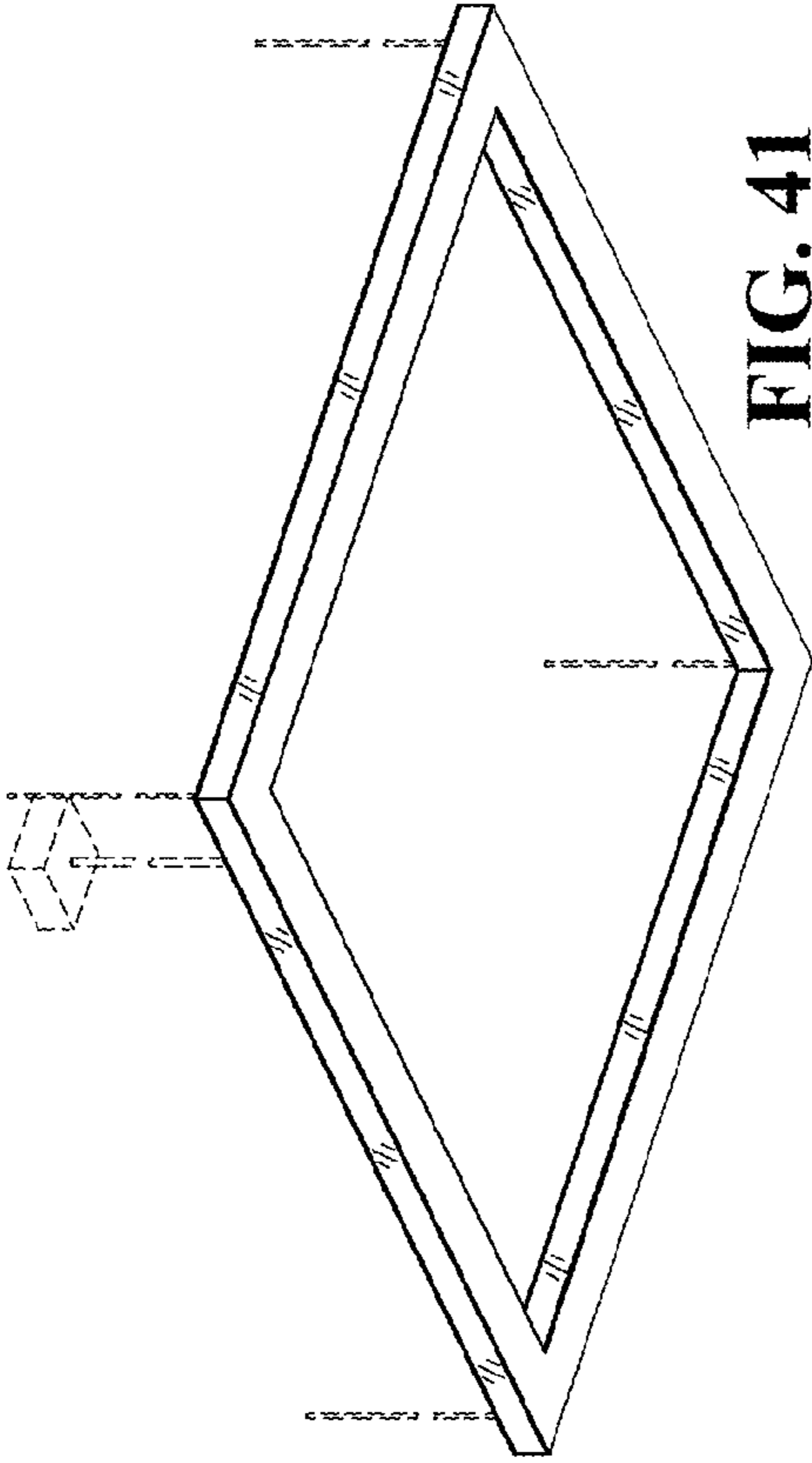

FIG. 41

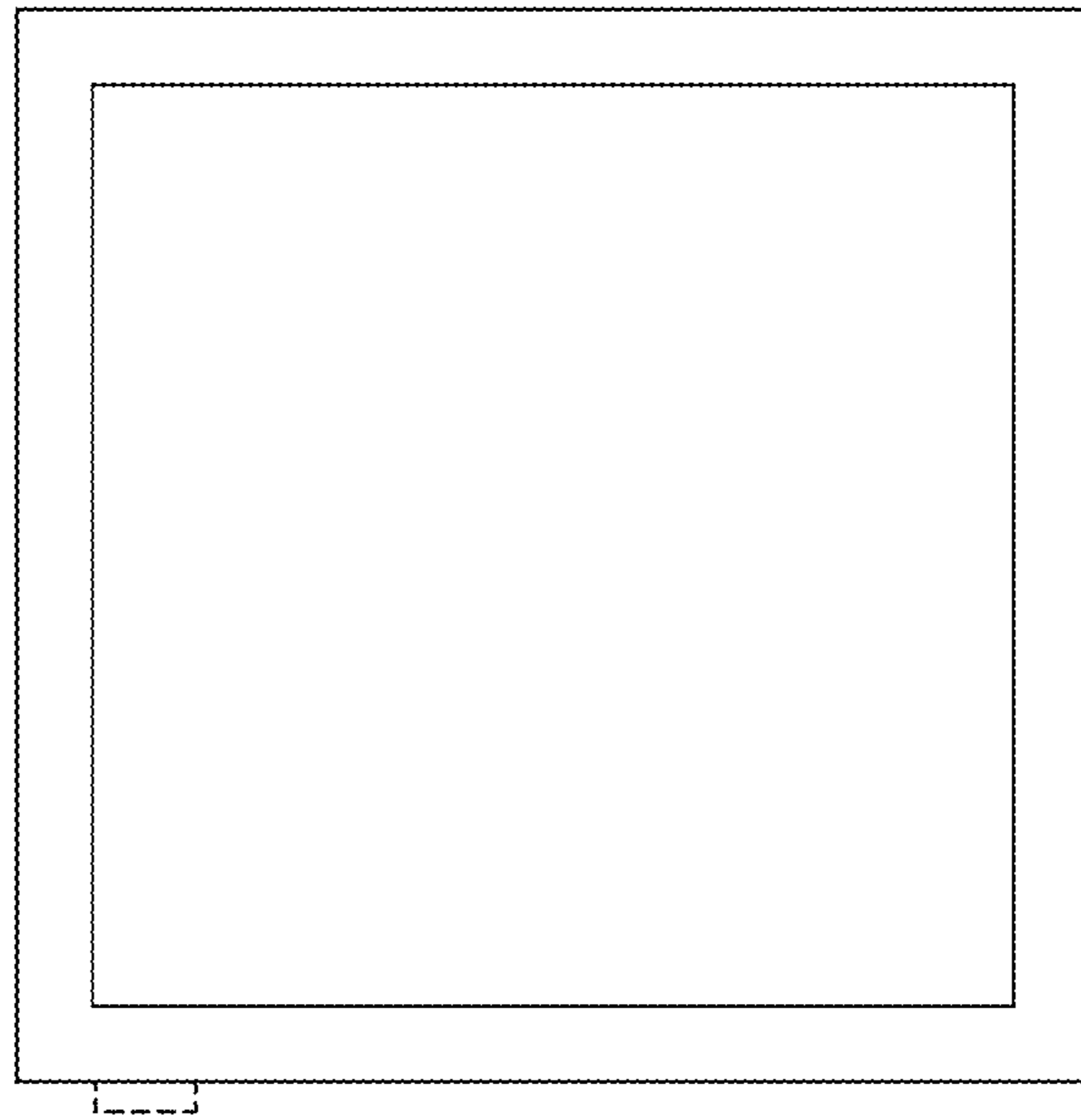

FIG. 39

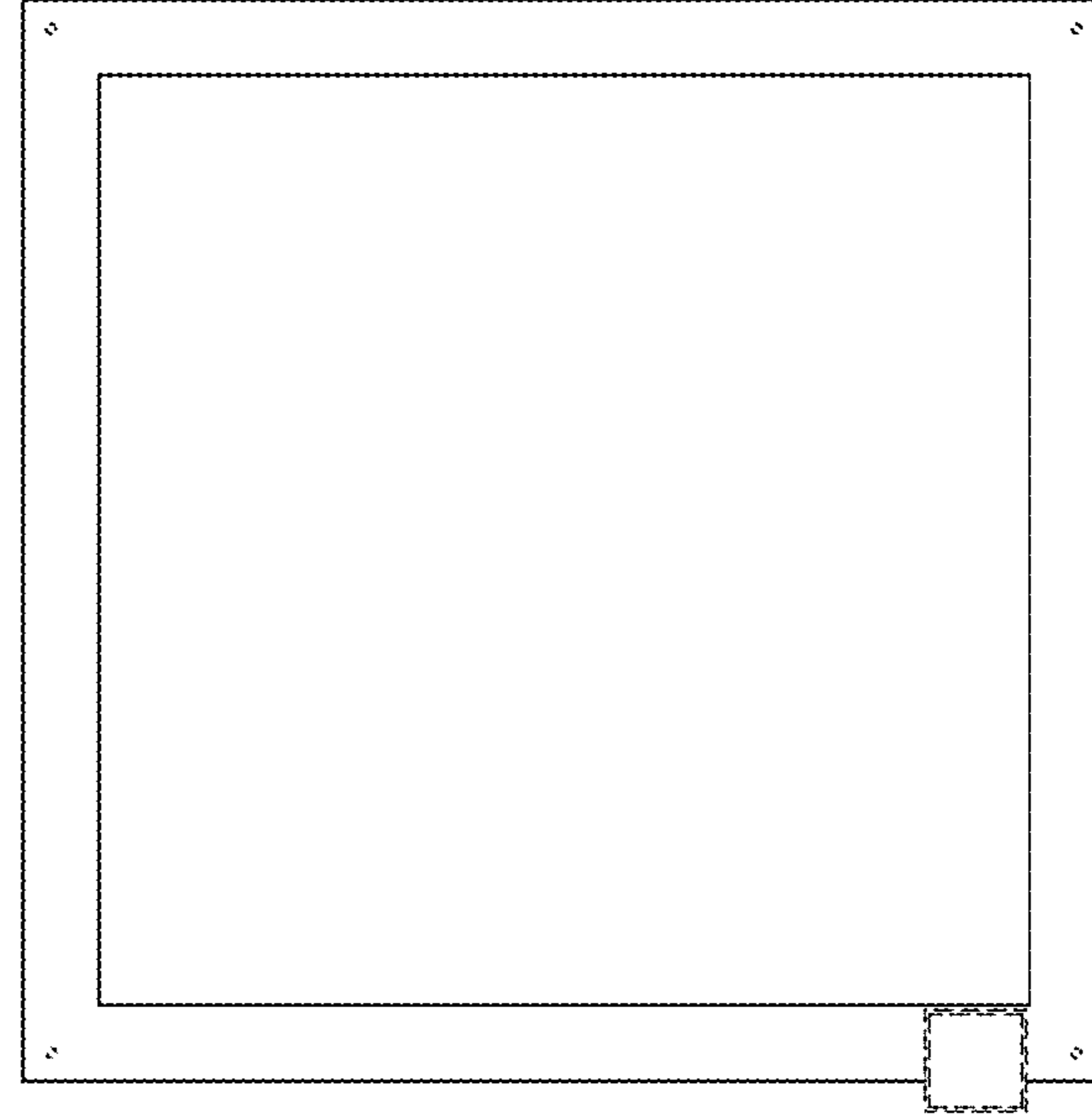

FIG. 40

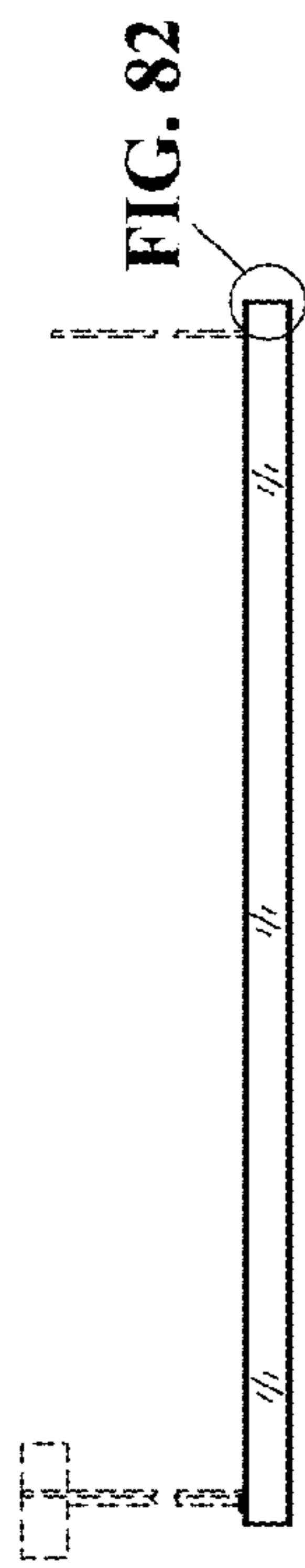

FIG. 43



FIG. 44

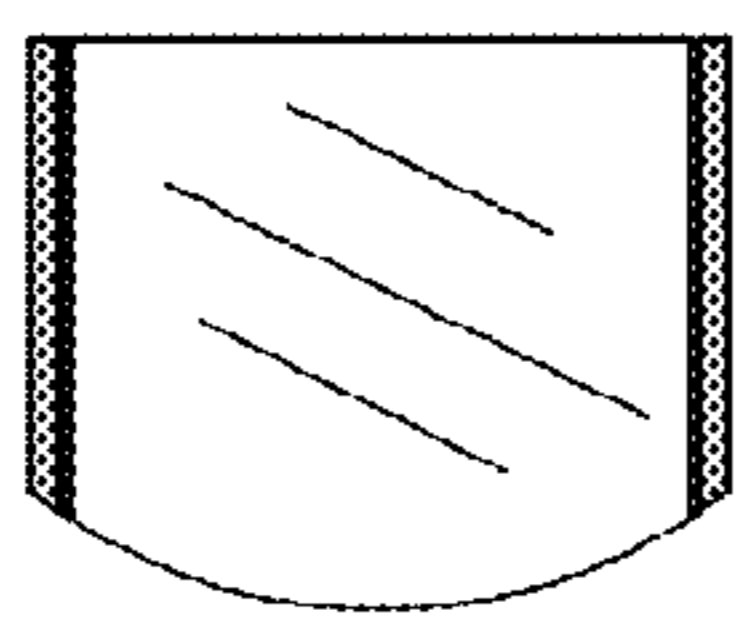

FIG. 48

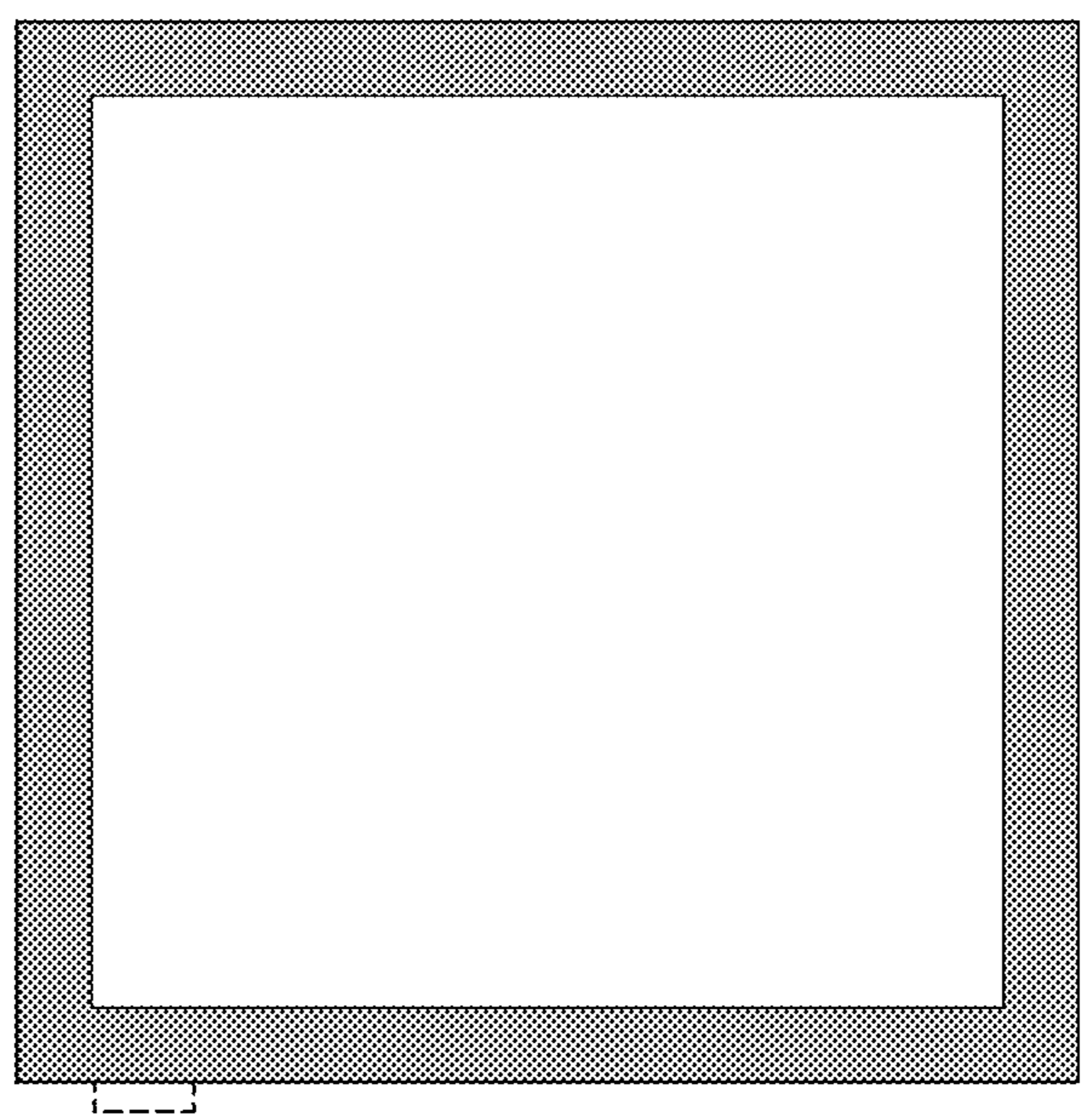

FIG. 45

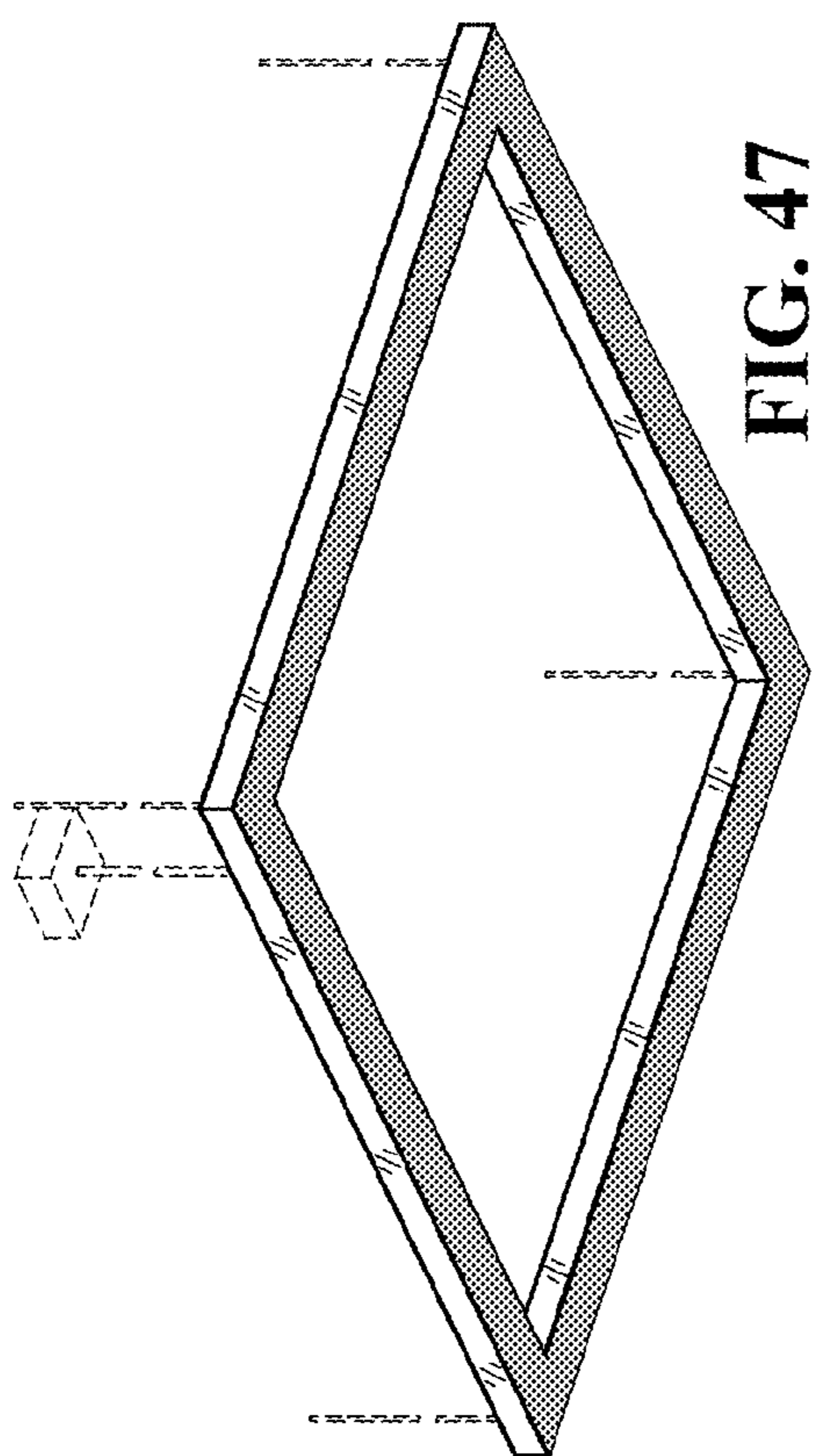

FIG. 47

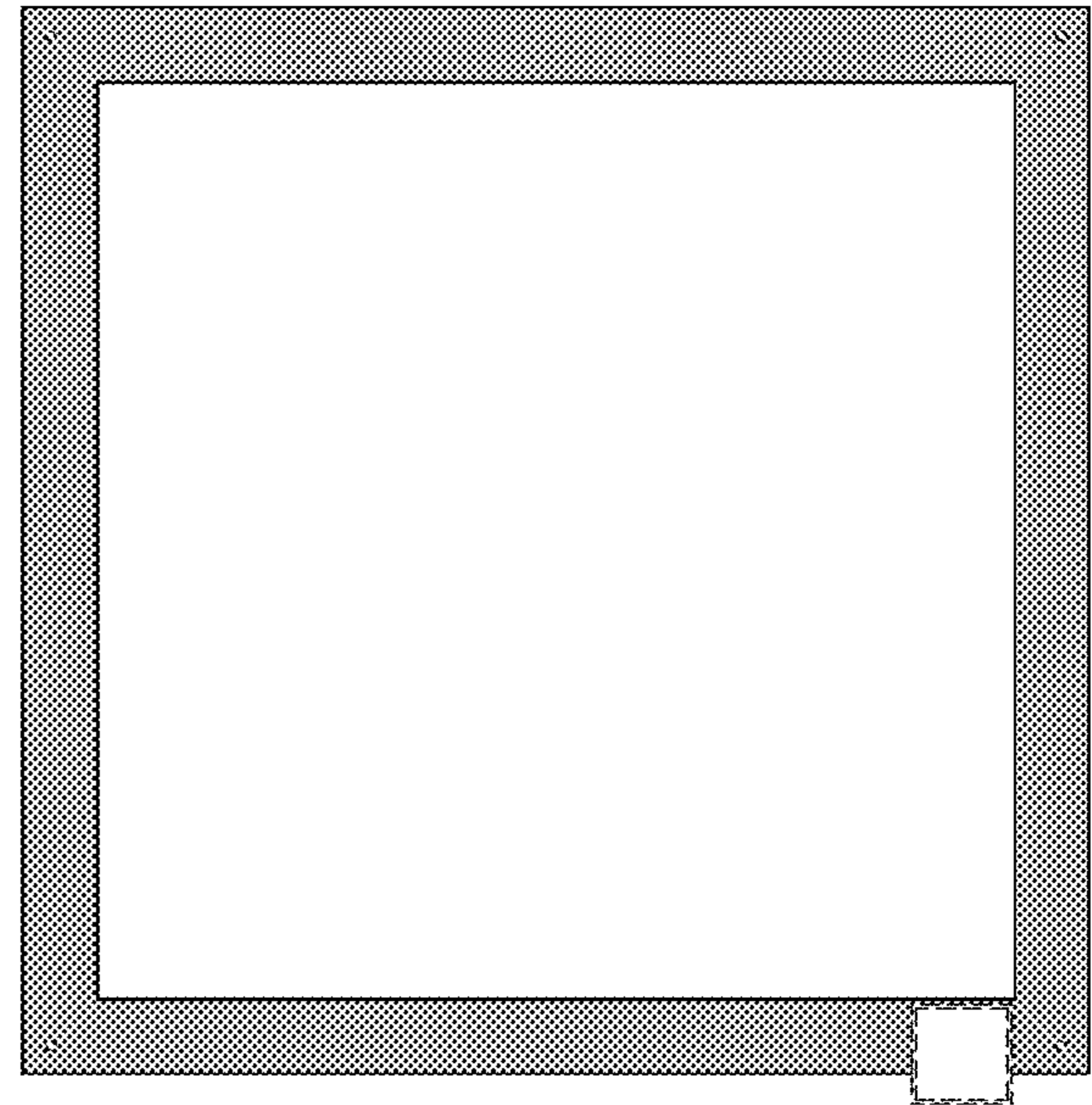

FIG. 46

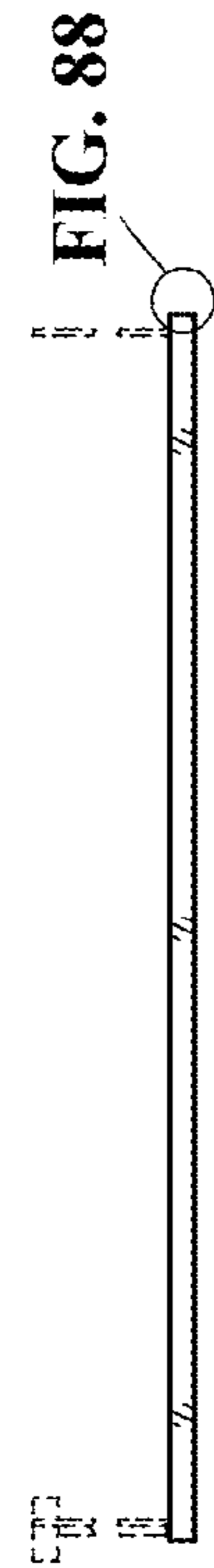

FIG. 49



FIG. 50

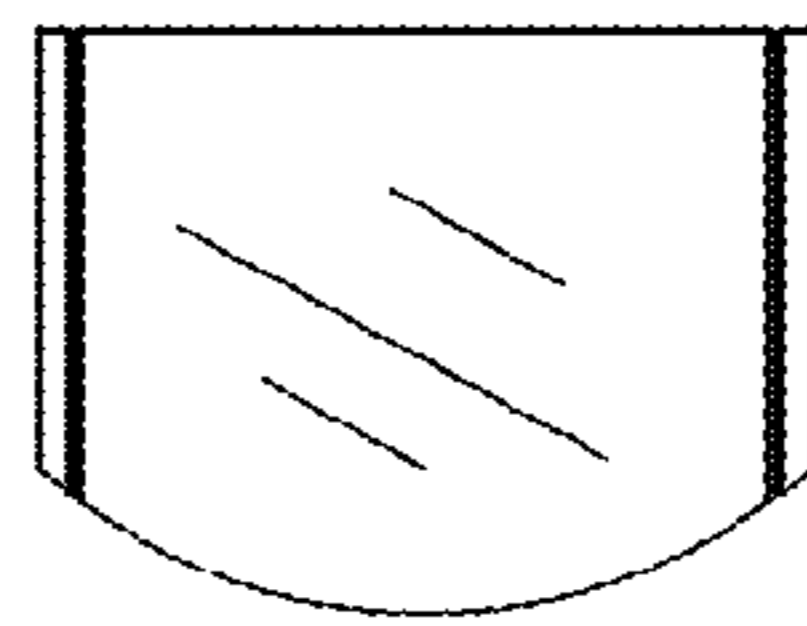

FIG. 54

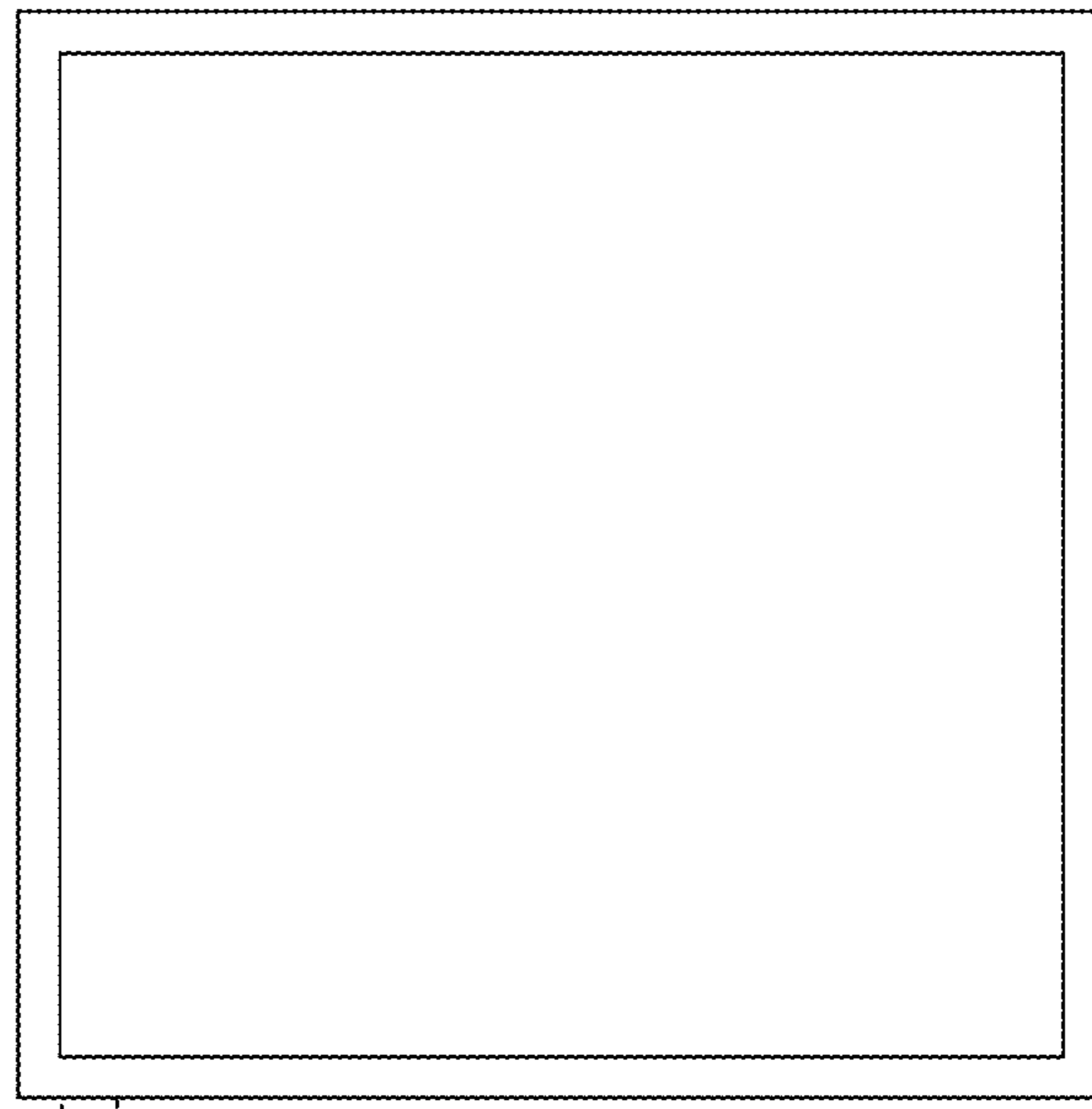

FIG. 51

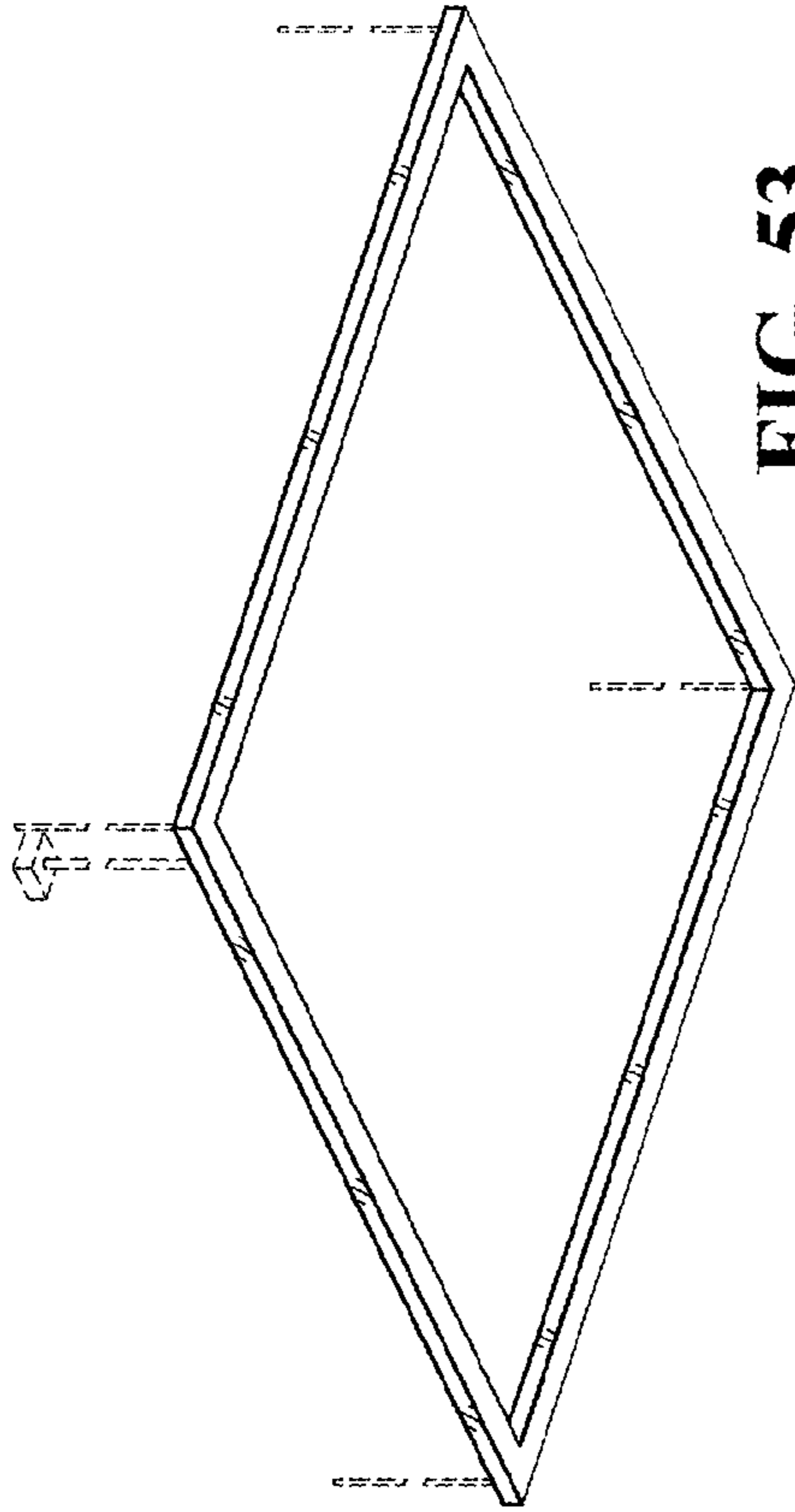

FIG. 53

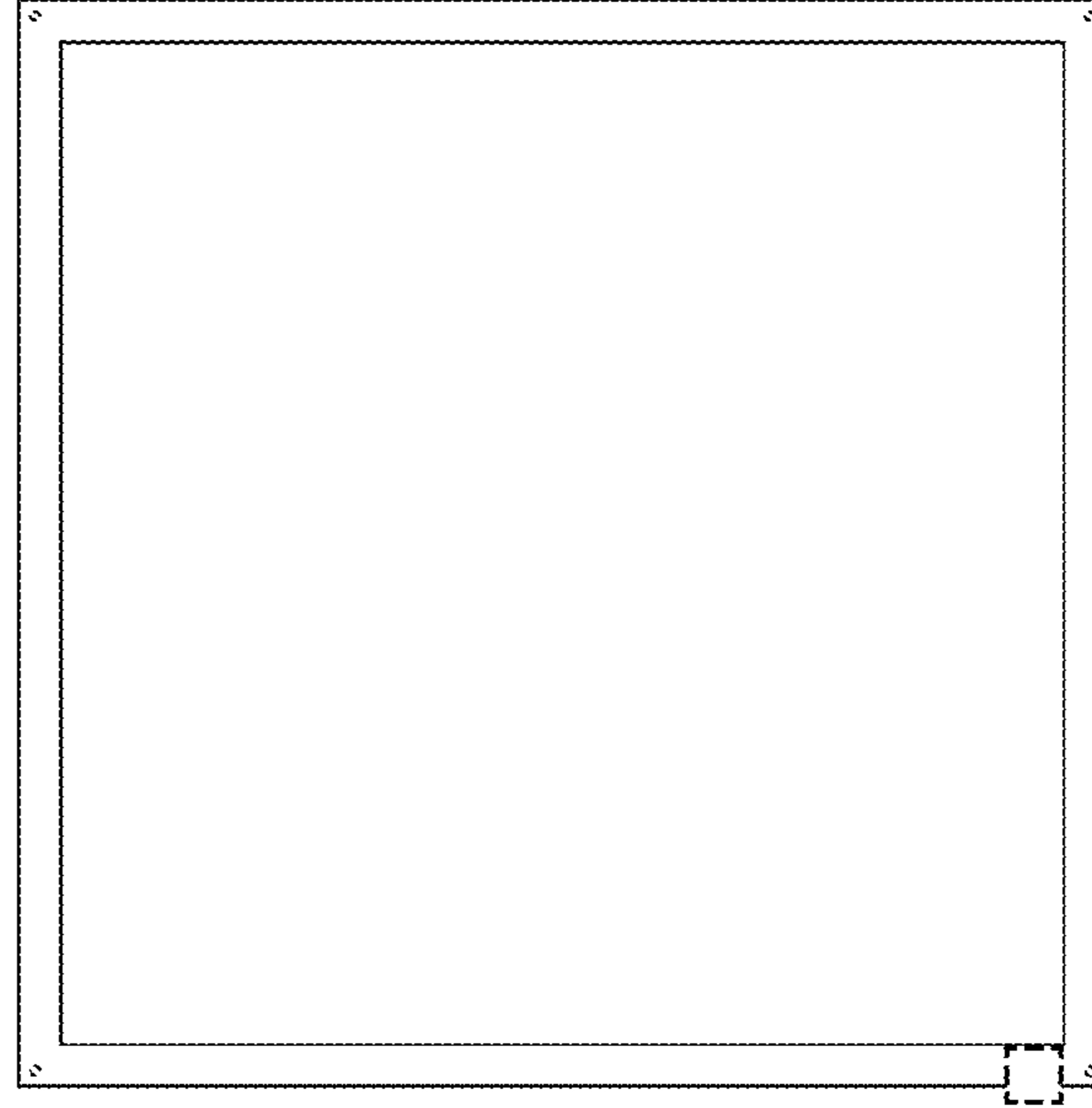

FIG. 52

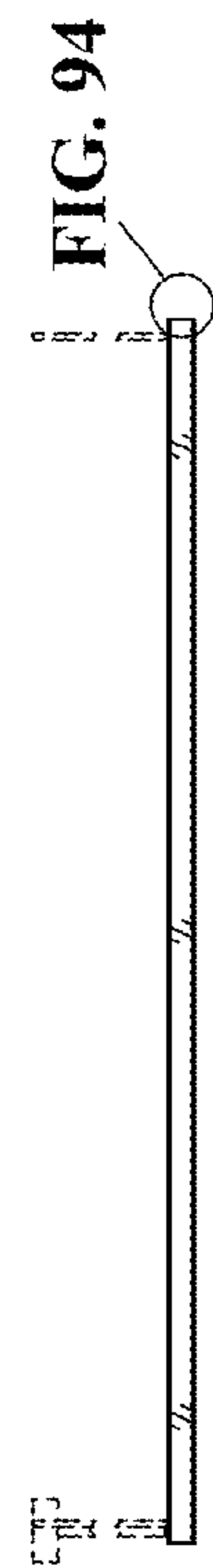

FIG. 55

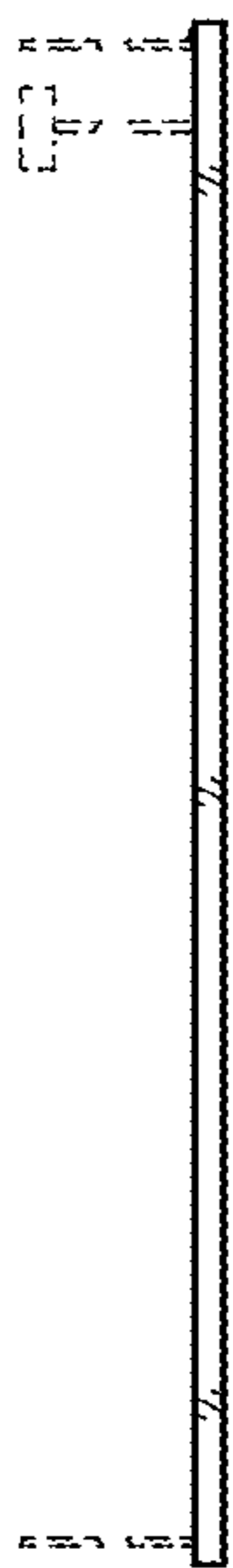

FIG. 56



FIG. 60

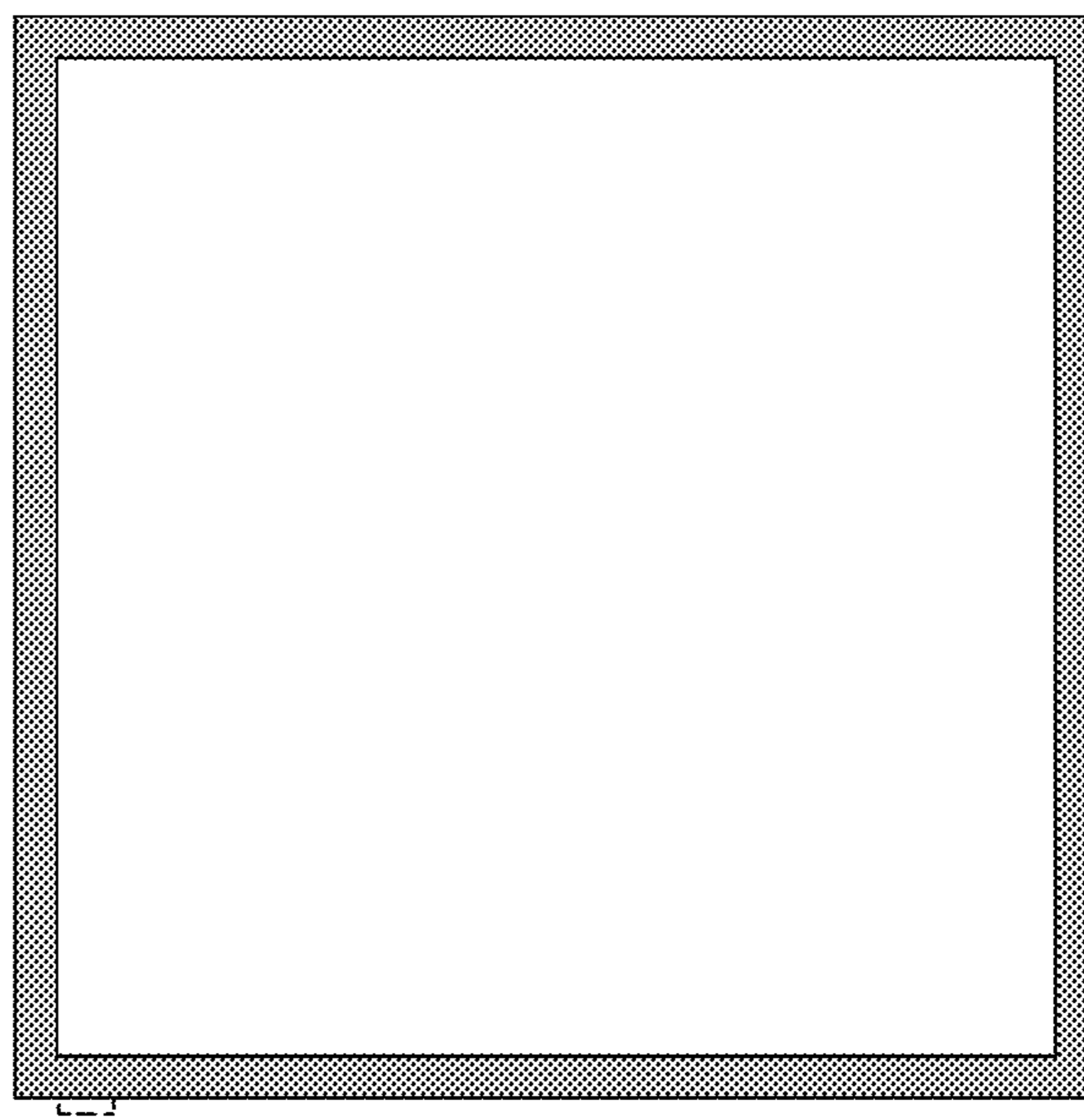

FIG. 57

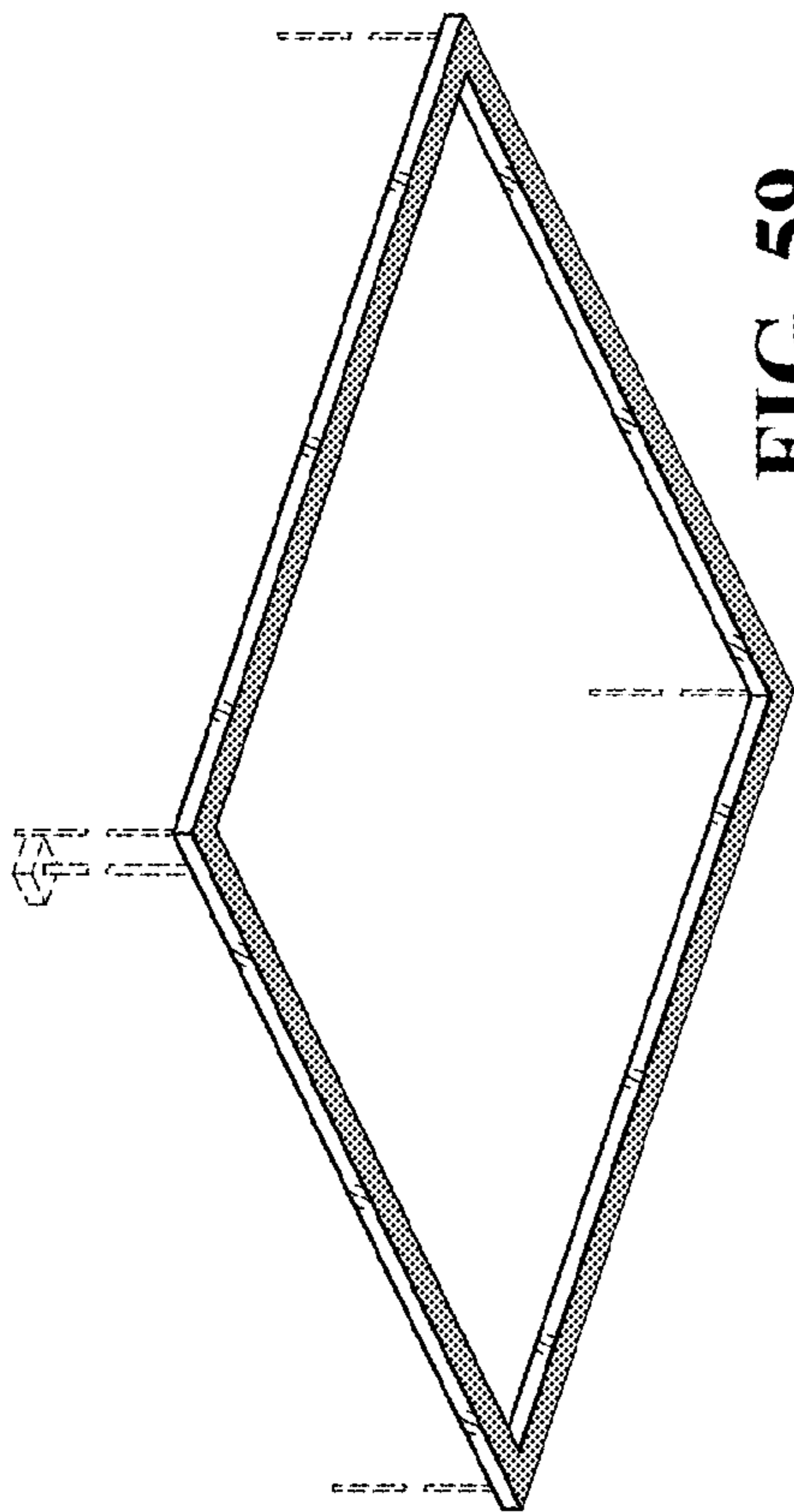

FIG. 59

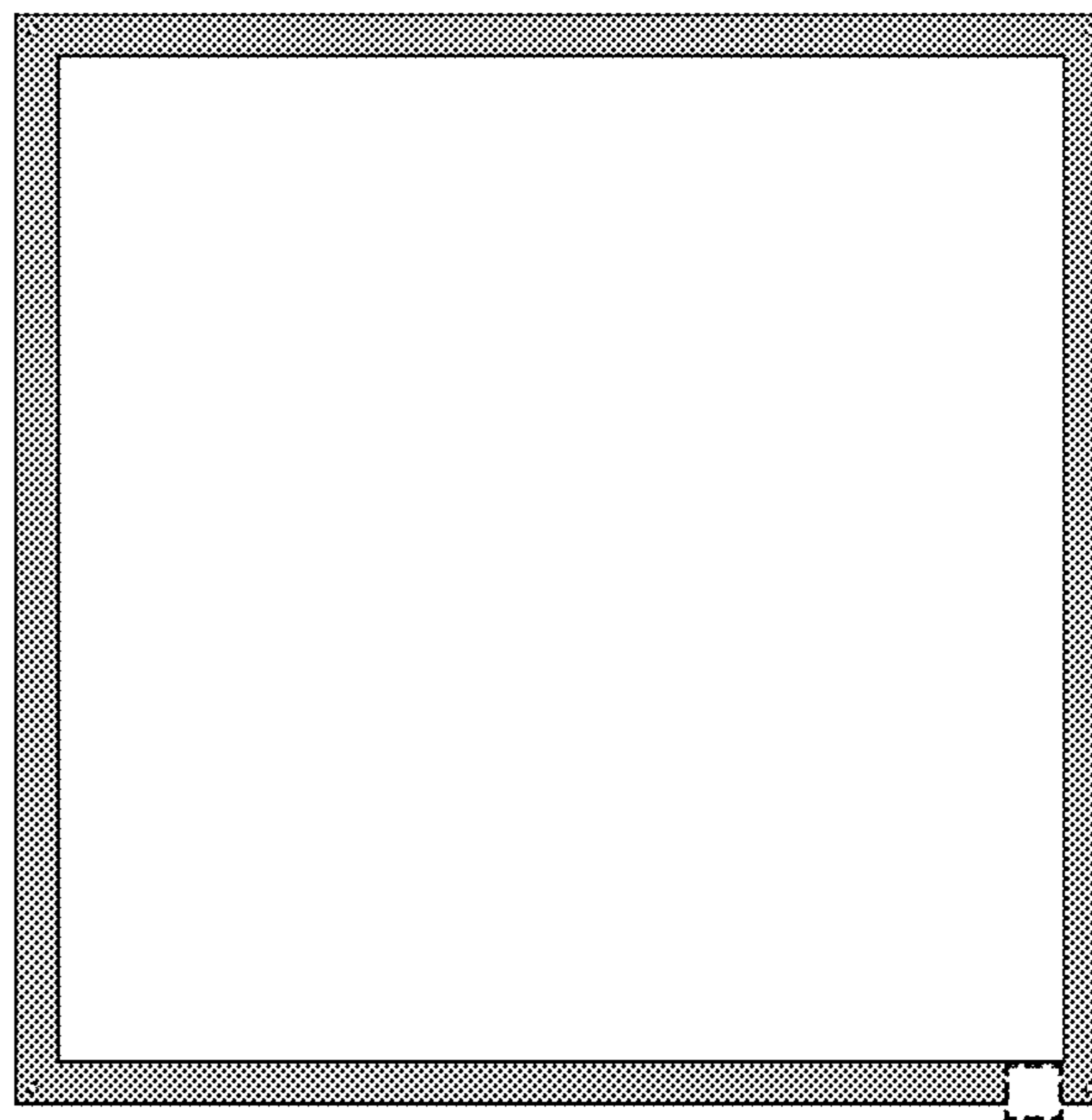

FIG. 58

