



US00D889677S

(12) **United States Design Patent** (10) **Patent No.:** **US D889,677 S**  
**Harmon** (45) **Date of Patent:** **\*\* Jul. 7, 2020**

(54) **LAMP WITH STAND**  
(71) Applicant: **Verilux, Inc.**, Waitsfield, VT (US)  
(72) Inventor: **Nicholas Harmon**, Waitsfield, VT (US)  
(73) Assignee: **Verilux, Inc.**, Waitsfield, VT (US)  
(\*\*) Term: **15 Years**

D704,851 S \* 5/2014 Douglas ..... D24/209  
D760,398 S \* 6/2016 Douglas ..... D24/210  
D760,913 S \* 7/2016 Douglas ..... D24/210  
9,482,382 B2 11/2016 Olsen et al.  
9,606,580 B2 3/2017 Garland, Sr. et al.  
D788,047 S \* 5/2017 Fremuth ..... D13/162  
D807,522 S \* 1/2018 Berke ..... D24/210  
D809,141 S \* 1/2018 Adams ..... D24/158

(Continued)

(21) Appl. No.: **29/667,744**  
(22) Filed: **Oct. 24, 2018**  
(51) **LOC (12) Cl.** ..... **24-01**  
(52) **U.S. Cl.**  
USPC ..... **D24/210**  
(58) **Field of Classification Search**  
USPC ..... D24/107, 186, 158, 231, 200, 209, 210;  
D26/29, 37, 39, 63, 104; D28/9, 44.1;  
D14/341, 138 R, 138 AA, 138 G  
CPC ..... A61N 5/0616; A61N 5/0618; A61N  
2005/0652; A61N 2005/0654; A61N  
2005/0642; A61N 2005/0627; A61N  
2005/0644; A61N 2005/0636; A61N  
2005/0626; A61B 2018/00452; A61B  
2018/1807

See application file for complete search history.

(56) **References Cited**

**U.S. PATENT DOCUMENTS**

5,843,074 A 12/1998 Cocilovo  
D466,115 S \* 11/2002 Hawkins ..... D14/341  
6,880,796 B2 4/2005 Khor et al.  
D558,460 S \* 1/2008 Yu ..... D14/341  
7,928,660 B2 4/2011 Skene  
D653,348 S \* 1/2012 Barker ..... D24/186  
8,201,687 B2 6/2012 Zelif et al.  
8,282,060 B2 10/2012 Fan  
8,523,124 B2 9/2013 Yuan et al.  
8,567,748 B2 10/2013 Zhou et al.  
D695,410 S \* 12/2013 Becker ..... D14/371  
8,611,076 B2 12/2013 Wetzel et al.

**OTHER PUBLICATIONS**

Happylight Therapy Lamps & Boxes, posted at verilux.com, no posting date, online, URL: <https://verilux.com/collections/happylight-therapy-lamps-boxes> (Year: 2019).\*

(Continued)

*Primary Examiner* — Anhdao Doan  
*Assistant Examiner* — Mary Shannon Malley  
(74) *Attorney, Agent, or Firm* — Whitmyer IP Group LLC

(57) **CLAIM**

The ornamental design for a lamp with stand, as shown and described.

**DESCRIPTION**

FIG. 1 is a perspective view of a lamp with stand in accordance with the new design;  
FIG. 2 is a back perspective view thereof;  
FIG. 3 is a front view thereof;  
FIG. 4 is a back view thereof;  
FIG. 5 is a side view thereof;  
FIG. 6 is a side view thereof;  
FIG. 7 is a top view thereof;  
FIG. 8 is a bottom view thereof;  
FIG. 9 is a back perspective view thereof, with the stand shown in an alternate position; and,  
FIG. 10 is a back view thereof, with the stand shown in an alternate position.

**1 Claim, 9 Drawing Sheets**

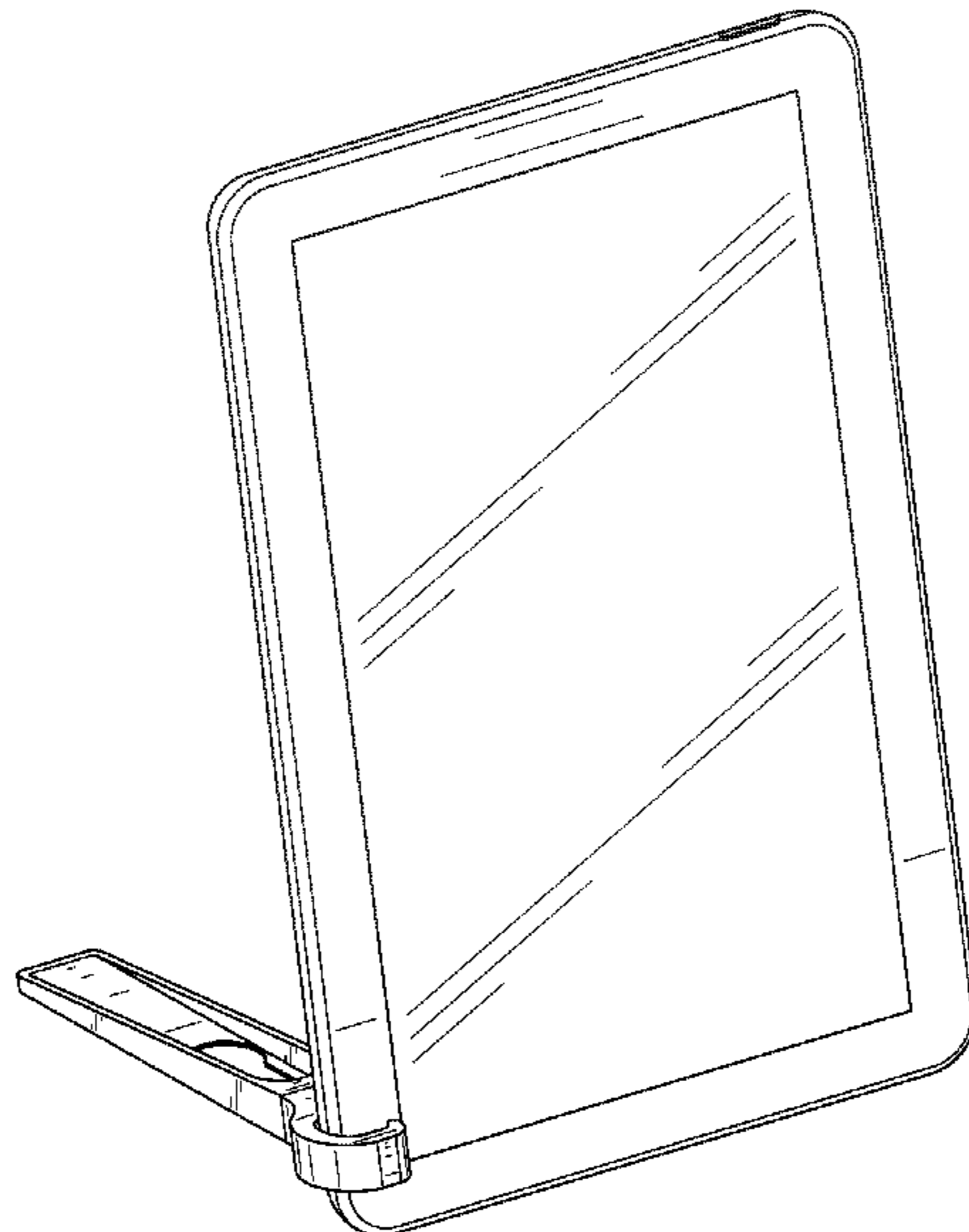

(56)

**References Cited**

U.S. PATENT DOCUMENTS

9,874,900 B2 1/2018 Mehandjiysky et al.  
D835,291 S \* 12/2018 Lei ..... D24/209  
10,159,816 B2 12/2018 Tsai et al.  
D844,791 S \* 4/2019 Henderson ..... D24/186  
D857,220 S \* 8/2019 Chew ..... D24/210  
2019/0076670 A1 3/2019 Vyshedskiy  
2019/0098725 A1 3/2019 Sadwick et al.

OTHER PUBLICATIONS

Alaska Northern Lights—Aurora LightPad User Guide [www.alaskanorthernlights.com](http://www.alaskanorthernlights.com) 12 Pages.  
Alaska Northern Light—Aurora LightPad Mini User Guide [www.alaskanorthernlights.com](http://www.alaskanorthernlights.com) 12 Pages.  
Beurer Phototherapy Unit TL 55 Day & Night User Guide 88 Pages.  
Beurer Phototherapy Unit TL 30 User Guide 56 Pages.  
How to Use HappyLight Touch LED Light Therapy Lamp <https://www.youtube.com/watch?v=Nu1NTMBg5fc> Accessed: Feb. 10, 2020.  
2 Pages (screenshots).

\* cited by examiner

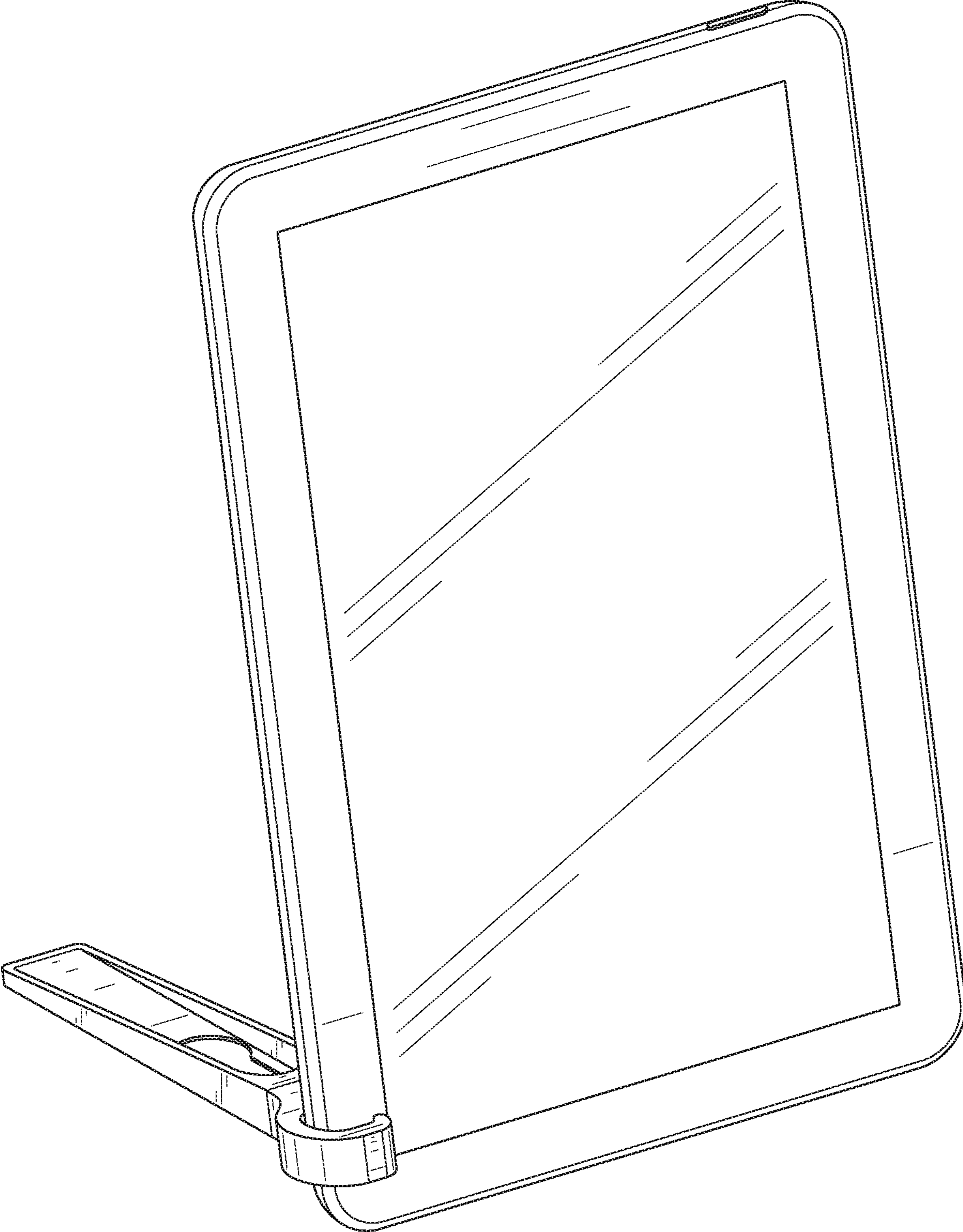

FIG. 1

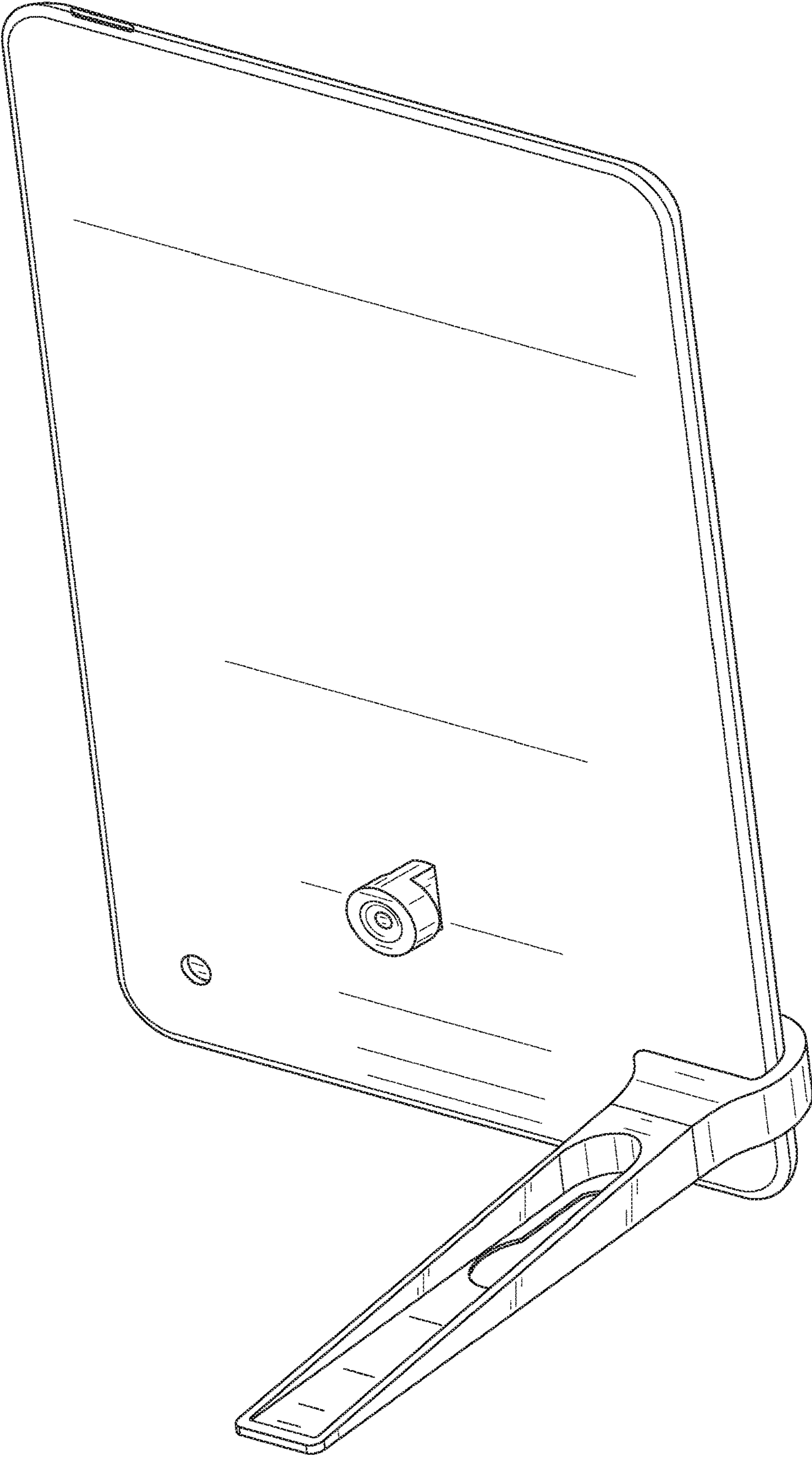

FIG. 2

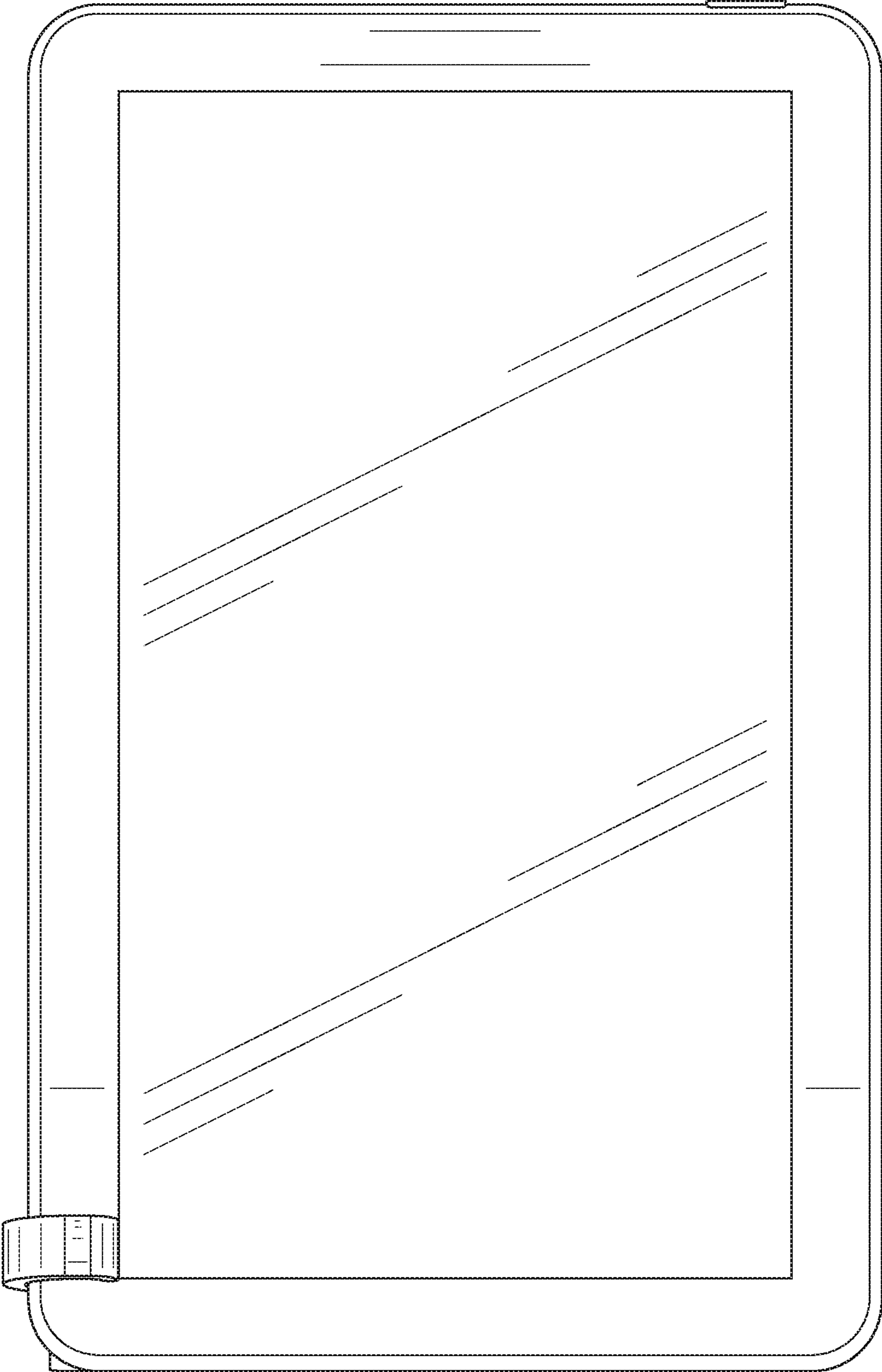

FIG. 3

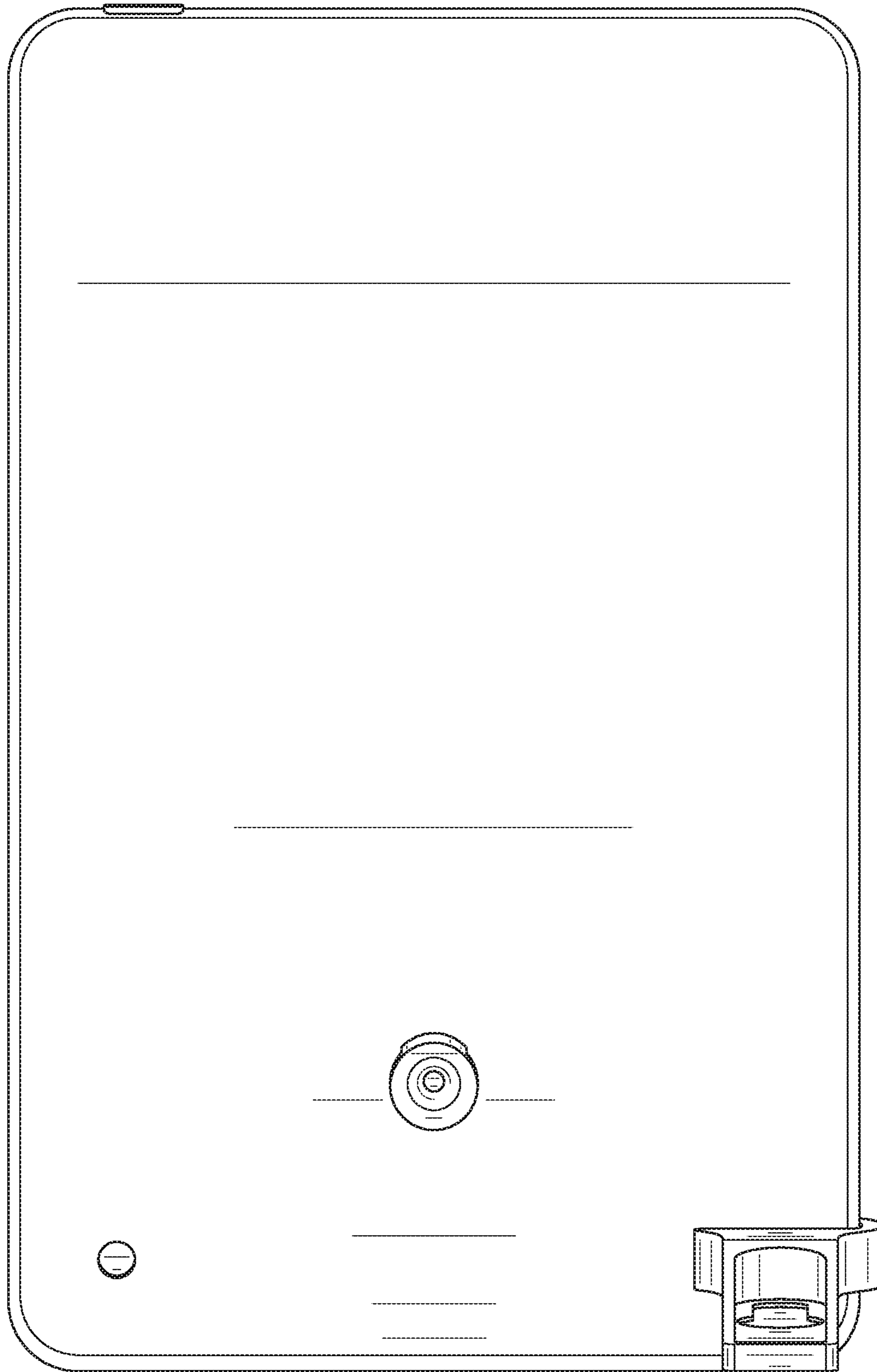

FIG. 4

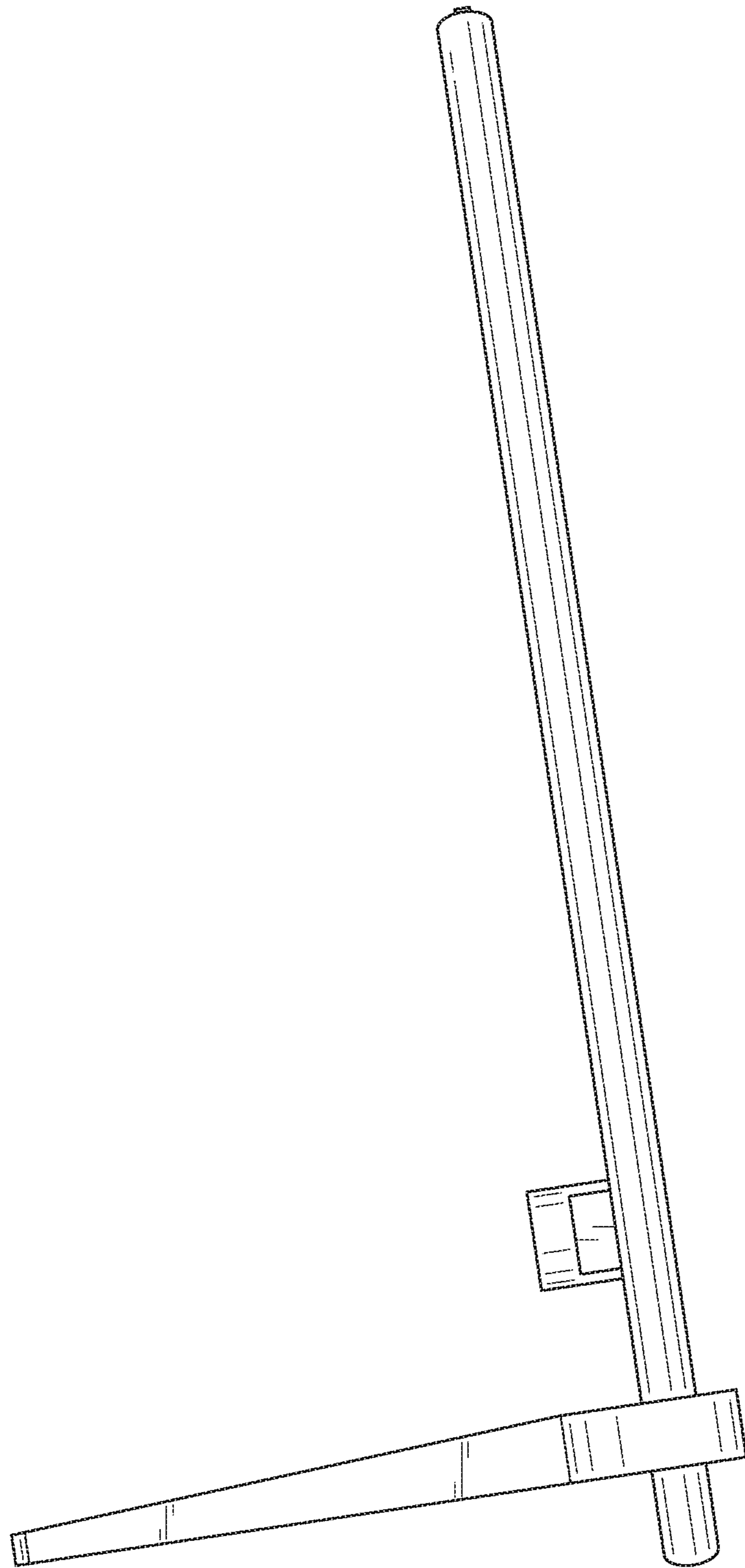

FIG. 5

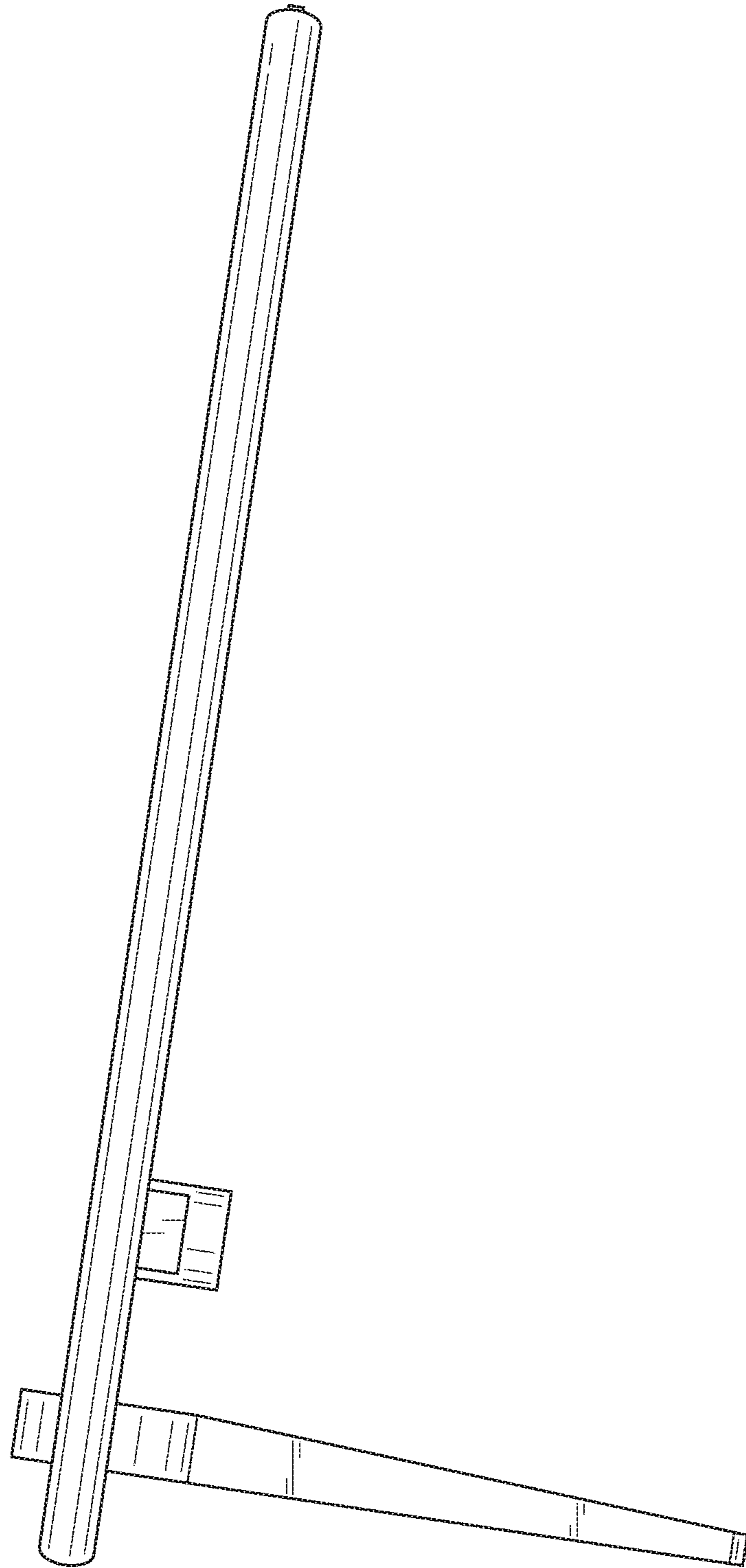

FIG. 6



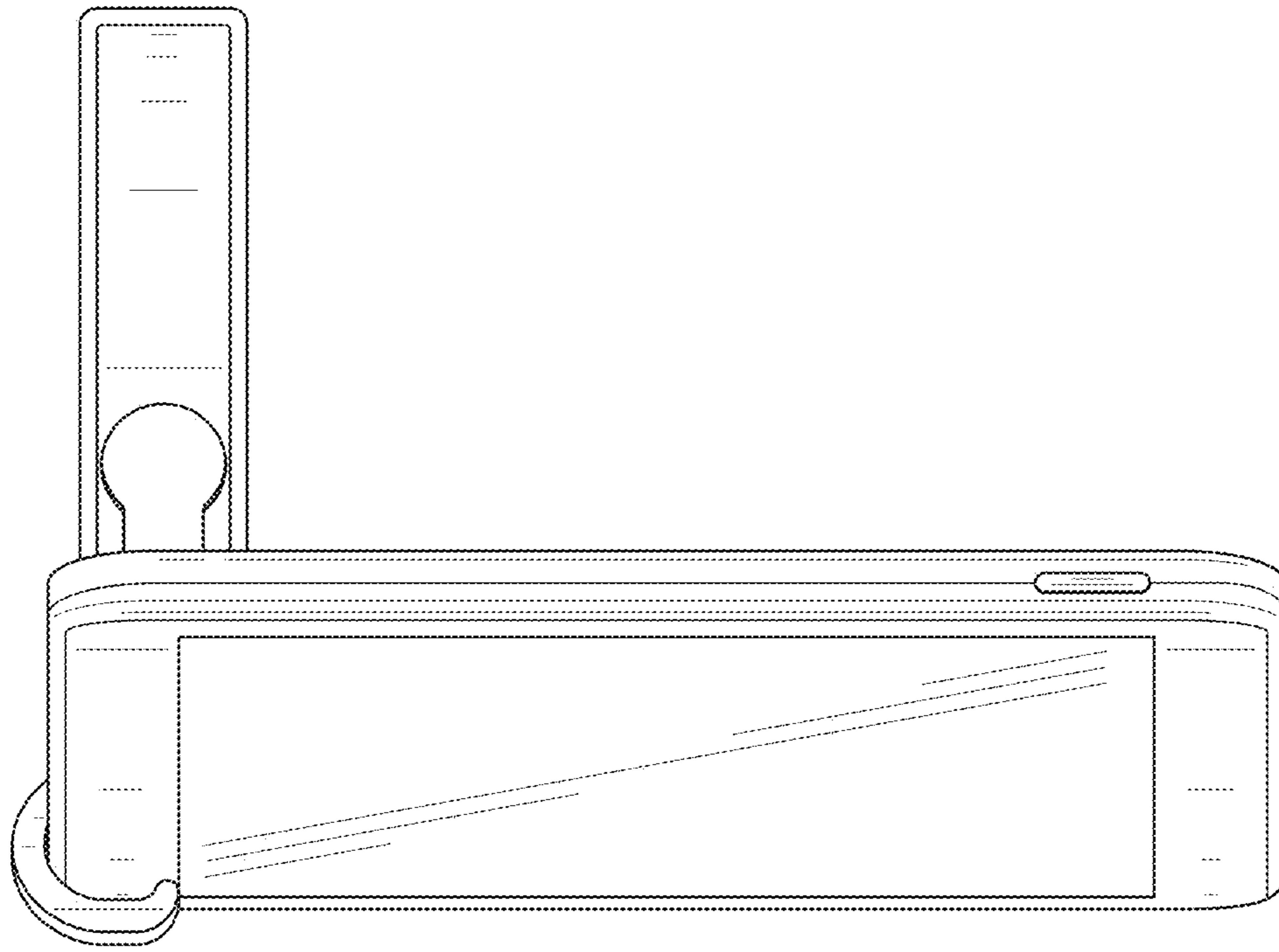

FIG. 7

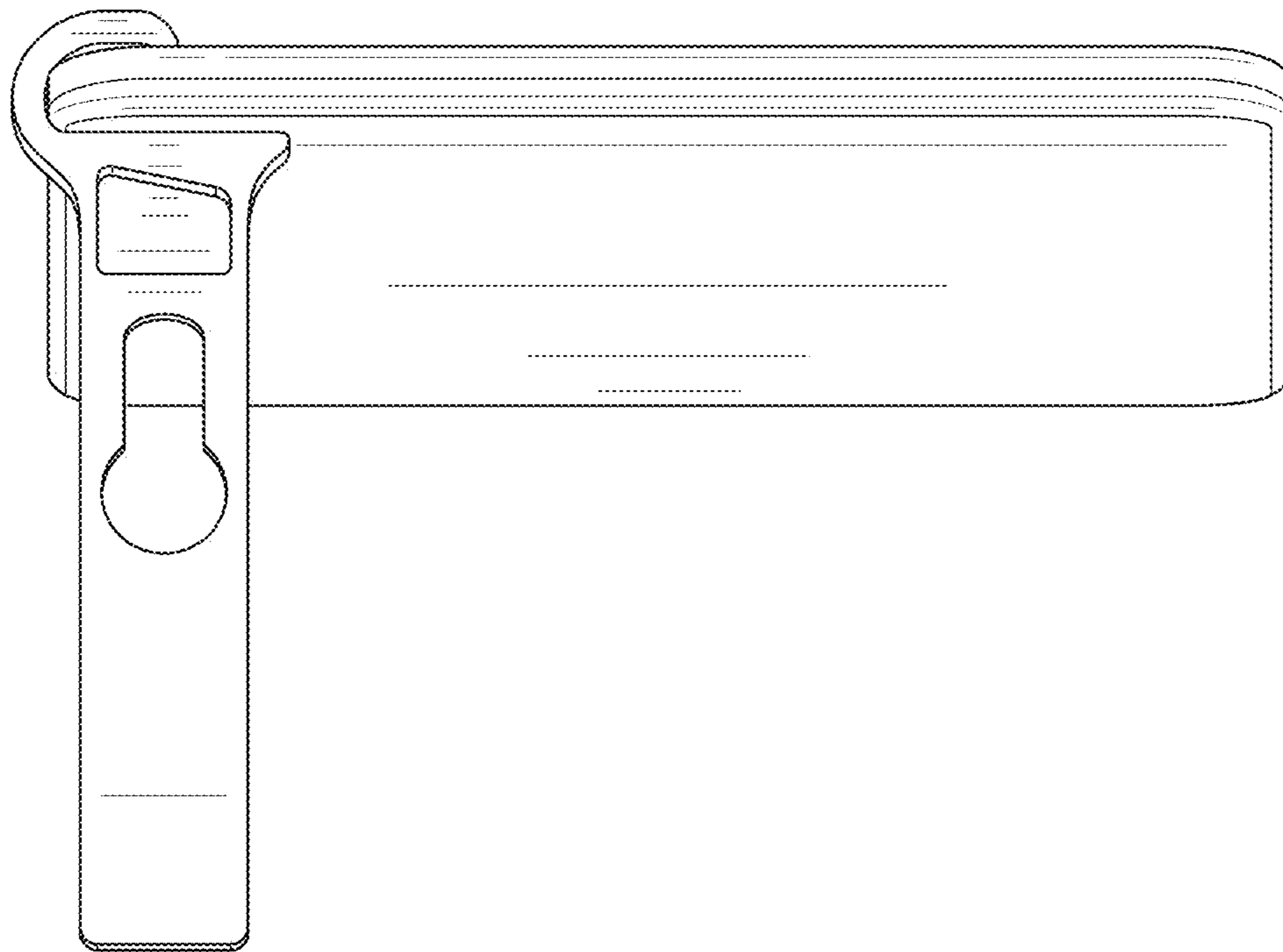

FIG. 8

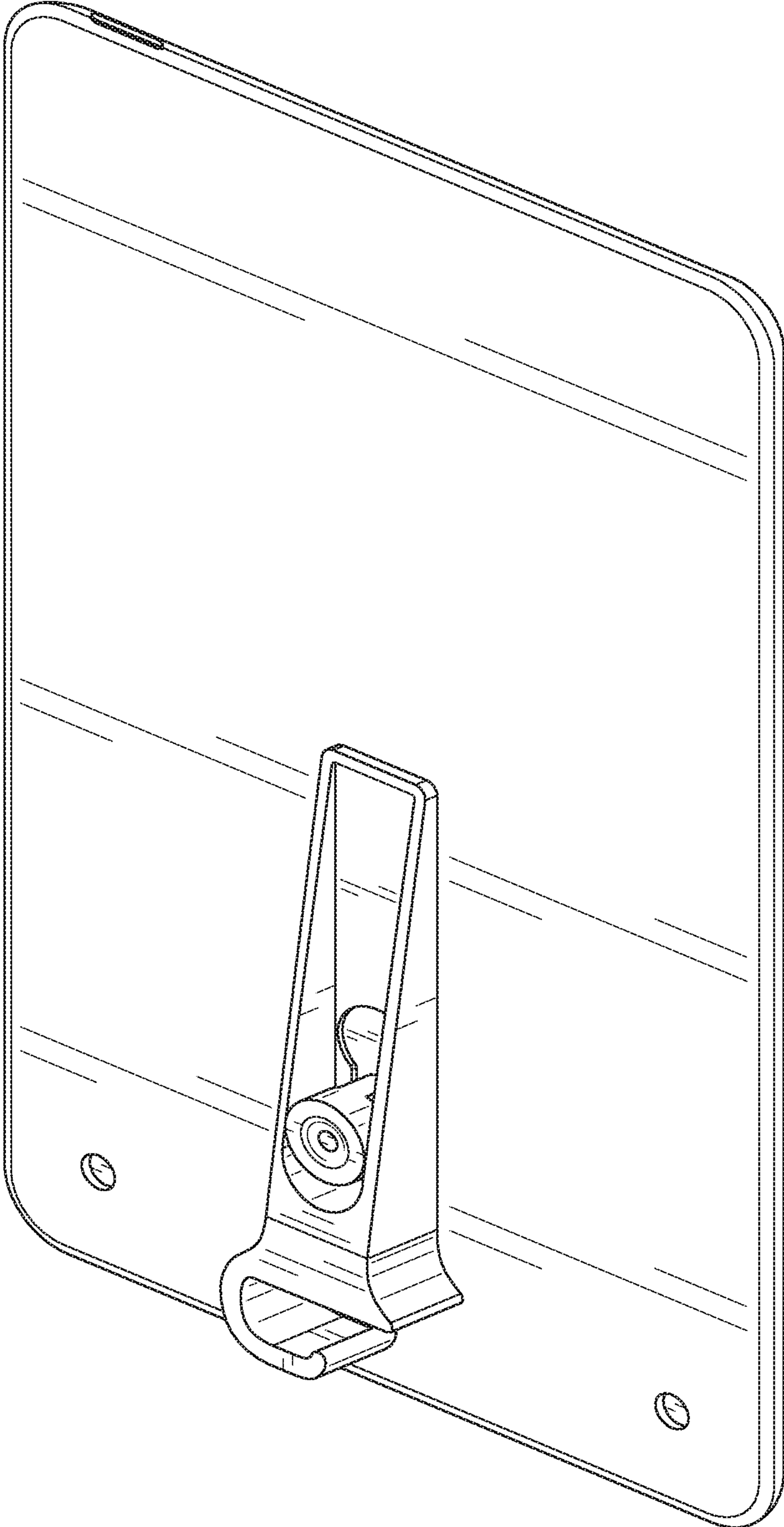

FIG. 9

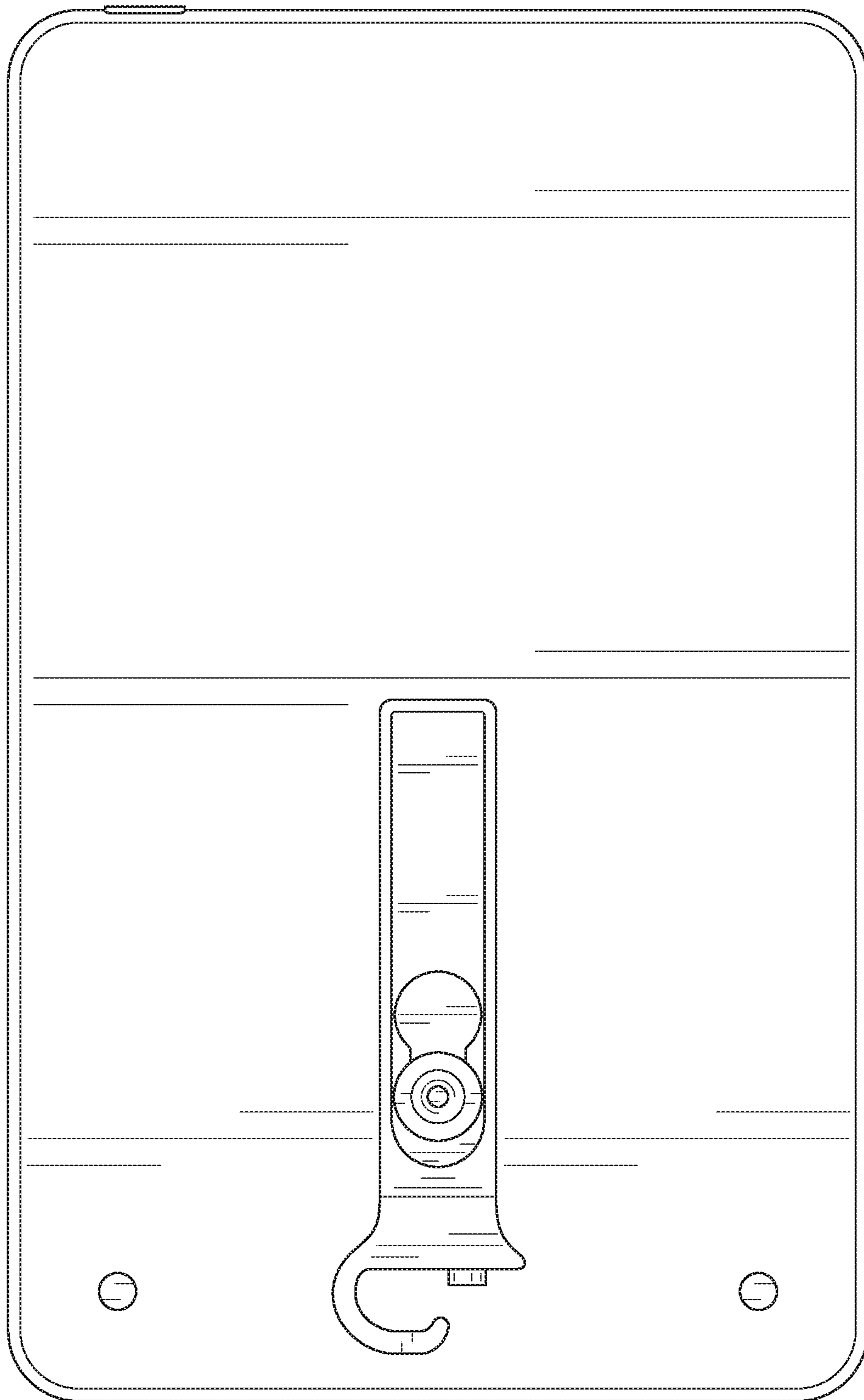

FIG. 10