



US00D889654S

(12) **United States Design Patent** (10) **Patent No.:** **US D889,654 S**
Limem et al. (45) **Date of Patent:** **** Jul. 7, 2020**

(54) **THREE DIMENSIONAL MASTOPEXY IMPLANT**

FOREIGN PATENT DOCUMENTS

(71) Applicant: **Tepha, Inc.**, Lexington, MA (US)

WO 2004096098 A1 11/2004
WO 2006117622 A1 11/2006

(Continued)

(72) Inventors: **Skander Limem**, Melrose, MA (US);
Said Rizk, Windham, NH (US); **Simon F. Williams**, Lexington, MA (US)

OTHER PUBLICATIONS

(73) Assignee: **Tepha, Inc.**, Lexington, MA (US)

“GalaFLEX Mesh . . . Supporting Your Quest for Timeless Beauty,”
Tepha, Inc. 400109 Rev.B, Oct. 2012.

(Continued)

(**) Term: **15 Years**

Primary Examiner — Charles D Hanson

(21) Appl. No.: **29/636,697**

(74) *Attorney, Agent, or Firm* — Richard Batt

(22) Filed: **Feb. 9, 2018**

(51) **LOC (12) Cl.** **24-03**

(57) **CLAIM**

(52) **U.S. Cl.**

The ornamental design for a three dimensional mastopexy implant, as shown and described.

USPC **D24/155**

(58) **Field of Classification Search**

USPC D24/155

CPC A61F 2/12

See application file for complete search history.

DESCRIPTION

(56) **References Cited**

U.S. PATENT DOCUMENTS

2,701,879	A	2/1955	Bennett
3,280,818	A	10/1966	Pankey et al.
3,934,593	A	1/1976	Mellinger
4,372,293	A	2/1983	Vijil-Rosales
4,936,858	A	6/1990	O’Keeffe
5,217,494	A	6/1993	Coggins et al.
5,356,429	A	10/1994	Seare
5,383,929	A	1/1995	Ledergerber
5,500,019	A	3/1996	Johnson et al.
5,545,221	A	8/1996	Hang-Fu
5,584,884	A	12/1996	Pignataro
5,658,328	A	8/1997	Johnson
5,676,161	A	10/1997	Breiner
5,716,404	A	2/1998	Vacanti et al.
5,755,611	A	5/1998	Noble et al.
5,759,204	A	6/1998	Seare
5,990,378	A	11/1999	Ellis

(Continued)

FIG. 1 is a front view of a three dimensional mastopexy implant showing our new design;
FIG. 2 is a left side view of the three dimensional mastopexy implant shown in FIG. 1;
FIG. 3 is a right side view of the three dimensional mastopexy implant shown in FIG. 1;
FIG. 4 is a bottom view of the three dimensional mastopexy implant shown in FIG. 1;
FIG. 5 is a top view of the three dimensional mastopexy implant shown in FIG. 1;
FIG. 6 is a rear view of the three dimensional mastopexy implant shown in FIG. 1; and,
FIG. 7 is a top, front, side perspective view of the three dimensional mastopexy implant shown in FIG. 1.
The broken lines shown in the figures form no part of the claimed design.

1 Claim, 4 Drawing Sheets

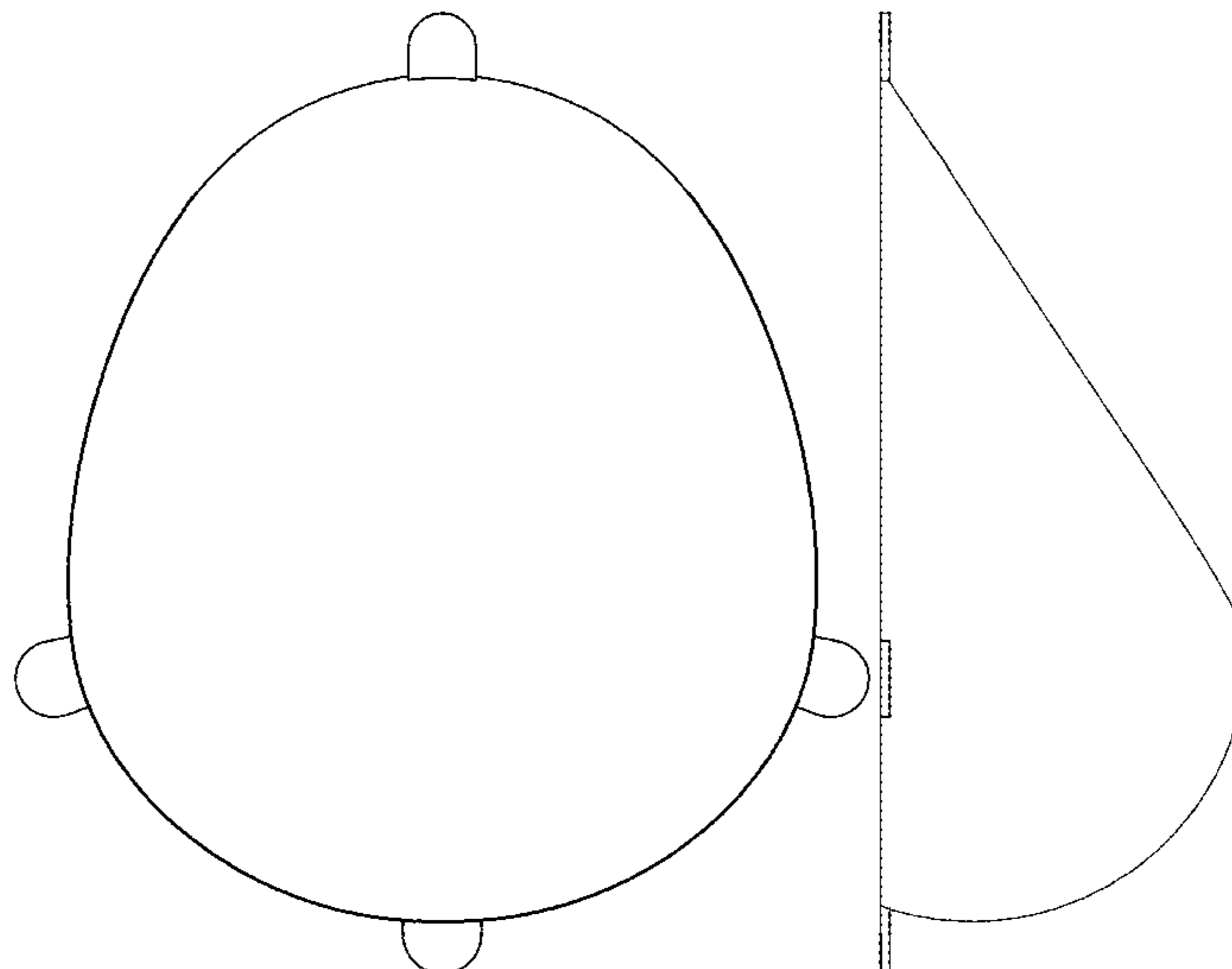

(56)

References Cited

U.S. PATENT DOCUMENTS

6,210,439 B1 4/2001 Firmin et al.
 6,328,765 B1 12/2001 Hardwick et al.
 6,368,541 B1 4/2002 Pajotin et al.
 6,371,831 B1 4/2002 Dodge
 6,599,323 B2 7/2003 Melican et al.
 6,723,133 B1 4/2004 Pajotin
 6,740,122 B1 5/2004 Pajotin
 6,913,626 B2 7/2005 Mcghan
 7,081,135 B2 7/2006 Smith et al.
 D539,506 S 4/2007 Valentin
 7,476,249 B2 1/2009 Frank
 7,520,896 B2 4/2009 Benslimane
 7,670,372 B2 3/2010 Shfaram et al.
 7,875,074 B2 1/2011 Chen et al.
 8,007,531 B2 8/2011 Frank
 8,034,270 B2 10/2011 Martin et al.
 8,858,629 B2 10/2014 Moses et al.
 8,911,765 B2 12/2014 Moses et al.
 8,936,504 B2 1/2015 Deal et al.
 8,986,377 B2 3/2015 Richter et al.
 9,532,867 B2 1/2017 Felix et al.
 9,603,698 B2 3/2017 Kerr et al.
 9,655,715 B2 5/2017 Limem et al.
 9,707,073 B2 7/2017 Al-Jasim
 9,713,350 B1 7/2017 Colburn
 9,713,524 B2* 7/2017 Glicksman A61B 90/02
 D799,152 S 10/2017 Brownell et al.
 D803,401 S * 11/2017 Limem D24/155
 D816,220 S * 4/2018 Limem D24/155
 D816,221 S * 4/2018 Limem D24/155
 D836,778 S * 12/2018 Limem D24/155
 10,363,127 B2 7/2019 Mlodinow et al.
 D856,517 S * 8/2019 Spiegel D24/155
 D857,895 S * 8/2019 Limem D24/155
 D870,289 S * 12/2019 Limem D24/155
 10,595,986 B2 3/2020 Rehnke
 2002/0165596 A1 11/2002 Wilson
 2003/0207649 A1 11/2003 Reeder
 2006/0167338 A1 7/2006 Shfaram et al.
 2006/0211334 A1 9/2006 Smith
 2007/0198085 A1 8/2007 Benslimane
 2008/0027273 A1* 1/2008 Gutterman A61B 17/84
 600/37
 2008/0082113 A1 4/2008 Bishop et al.
 2008/0097601 A1 4/2008 Codori-Hurff et al.
 2009/0082864 A1 3/2009 Chen et al.
 2009/0240342 A1 9/2009 Lindh, Sr. et al.
 2009/0248071 A1 10/2009 Saint et al.
 2010/0042211 A1 2/2010 Epps et al.
 2010/0137679 A1 6/2010 Lashinski et al.
 2010/0191330 A1 7/2010 Laurysen et al.
 2010/0204791 A1 8/2010 Shfaram et al.
 2010/0217388 A1* 8/2010 Cohen A61F 2/0059
 623/8
 2010/0249924 A1 9/2010 Powell et al.
 2010/0331612 A1 12/2010 Lashinski et al.
 2011/0009960 A1 1/2011 Altman et al.
 2011/0022171 A1 1/2011 Richter et al.
 2011/0257665 A1 10/2011 Mortarino
 2011/0264213 A1 10/2011 DeMiranda
 2012/0004723 A1 1/2012 Mortarino et al.
 2012/0021738 A1 1/2012 Koo et al.
 2012/0022646 A1 1/2012 Mortarino et al.
 2012/0158134 A1 6/2012 Codori-Hurff et al.
 2012/0185041 A1 7/2012 Mortarino et al.
 2012/0221105 A1 8/2012 Altman et al.
 2012/0232653 A1 9/2012 Saint et al.
 2012/0266348 A1 10/2012 Meginnis
 2012/0283826 A1 11/2012 Moses et al.
 2013/0066423 A1 3/2013 Bishop et al.
 2013/0103149 A1 4/2013 Altman et al.
 2013/0178699 A1 7/2013 Saint et al.
 2013/0178875 A1 7/2013 Horton et al.
 2013/0253645 A1 9/2013 Kerr et al.
 2013/0304098 A1 11/2013 Mortarino

2014/0081398 A1 3/2014 Mejia et al.
 2014/0200396 A1 7/2014 Lashinski et al.
 2014/0222146 A1 8/2014 Moses et al.
 2014/0222161 A1 8/2014 Mathisen
 2014/0276997 A1 9/2014 Harrah et al.
 2015/0012089 A1 1/2015 Shetty et al.
 2015/0018946 A1 1/2015 Guterma
 2015/0056131 A1 2/2015 Bernasconi et al.
 2015/0223928 A1 8/2015 Limem et al.
 2015/0351899 A1 12/2015 Mortarino
 2015/0351900 A1* 12/2015 Glicksman A61B 90/94
 623/8
 2016/0038269 A1 2/2016 Altman et al.
 2016/0151138 A1 6/2016 Guterma et al.
 2016/0310262 A1 10/2016 Doucet et al.
 2019/0247180 A1 8/2019 Limem et al.

FOREIGN PATENT DOCUMENTS

WO 2007004214 A3 5/2007
 WO 2009001293 A1 12/2008
 WO 2011119742 A2 9/2011
 WO 2012122215 A2 9/2012
 WO 2019094861 A1 5/2019
 WO 2019119060 A1 6/2019

OTHER PUBLICATIONS

“GalaFLEX Mesh,” Tepha Inc., www.galateasurgical.com, P/N 400124, Rev.A, Oct. 2013.
 Auclair, et al, “Repair of mammary ptosis by insertion of an internal absorbable support and periareolar scar,” Ann Chir Plast Esthet, 1993, 38, No. 1, pp. 107-113.
 DeBruijn, et al, “Mastopexy with Mesh Reinforcement: The Mechanical Characteristics of Polyester Mesh in the Female Breast,” Plast. Reconstr. Surg. 124: 364, 2009.
 European Search and Opinion dated Jul. 3, 2017, for 12754773.5-1666.
 Goes, “Periareolar mammoplasty: double skin technique with application of polyglactine or mixed mesh,” Plast. Reconstr. Surg., 97-859-68 (1996).
 Goes, “Periareolar mammoplasty: double-skin technique with application of mesh support,” Clin Plastic Surg 29 (2002) 349-364.
 Goes, “Periareolar Mastopexy with FortaPerm,” Aesth. Plast. Surg., 34-350-8, 2010.
 Hans P. deBrujin, Siegmund Johannes, “Mastopexy with 3D Preshaped Mesh for Long Term Results: Development of the Internal Bra System,” Aesth Plast Surg., 32:757-765, DOI 10.1007/s00266-008-9186-y, 2008.
 Johnson, “Central core reduction mammoplasties and Marlex suspension of breast tissue”.
 Malluci, Concepts in aesthetic breast dimensions: Analysis of the ideal breast, Journal of Plastic, Reconstructive & Aesthetic Surgery (2012) 65, p. 8-16.
 Malluci, Population Analysis of the Perfect Breast: A Morphometric Analysis, (2014), www.PRSJournal.com, vol. 134, No. 3 • The Perfect Breast, p. 436-447.
 P. van Deventer, Improving the Longevity and Results of Mastopexy and Breast Reduction Procedures: Reconstructing an Internal Breast Support System with Biocompatible Mesh to Replace the Supporting Function of the Ligamentous Suspension, Aesth Plast Surg (2012) 36:578-589DOI 10.1007/s00266-011-9845-2.
 Supplementary European Search Report of the EPO dated Jul. 30, 2014, EP 12754773.5 from PCT/US2012/027075.
 Williams, “Poly-4-hydroxybutyrate (P4HB): a new generation of resorbable medical devices for tissue repair and regeneration,” DOI 10.1515/bmt-2013-0009 Biomed Tech 2013; 58(5): 439-452.
 Written Opinion of IPEA dated Jun. 15, 2015 for PCT/US2014/046420.
 Written Opinion of ISR dated Nov. 5, 2012 for PCT/US2012/027975.
 U.S. Appl. No. 16/587,903, filed Sep. 2019, Limem.
 U.S. Appl. No. 62/939,786, filed Nov. 2019, Limem.

(56)

References Cited

OTHER PUBLICATIONS

Goes, Periareolar Mammoplasty: Double Skin Technique with Application of Polyglactine or Mixed Mesh, *Plastic Reconstructive Surg.*, vol .97, No. 5, Apr. 1996, 960-968.

International Search Report for PCT/US2019/015849, Dated Apr. 23, 2019.

Malluci, Design for Natural Breast Augmentation: The Ice Principle, *Plastic and Reconstructive Surgery*, Jun. 2016, vol. 137. No. 6, 1728-1737.

* cited by examiner

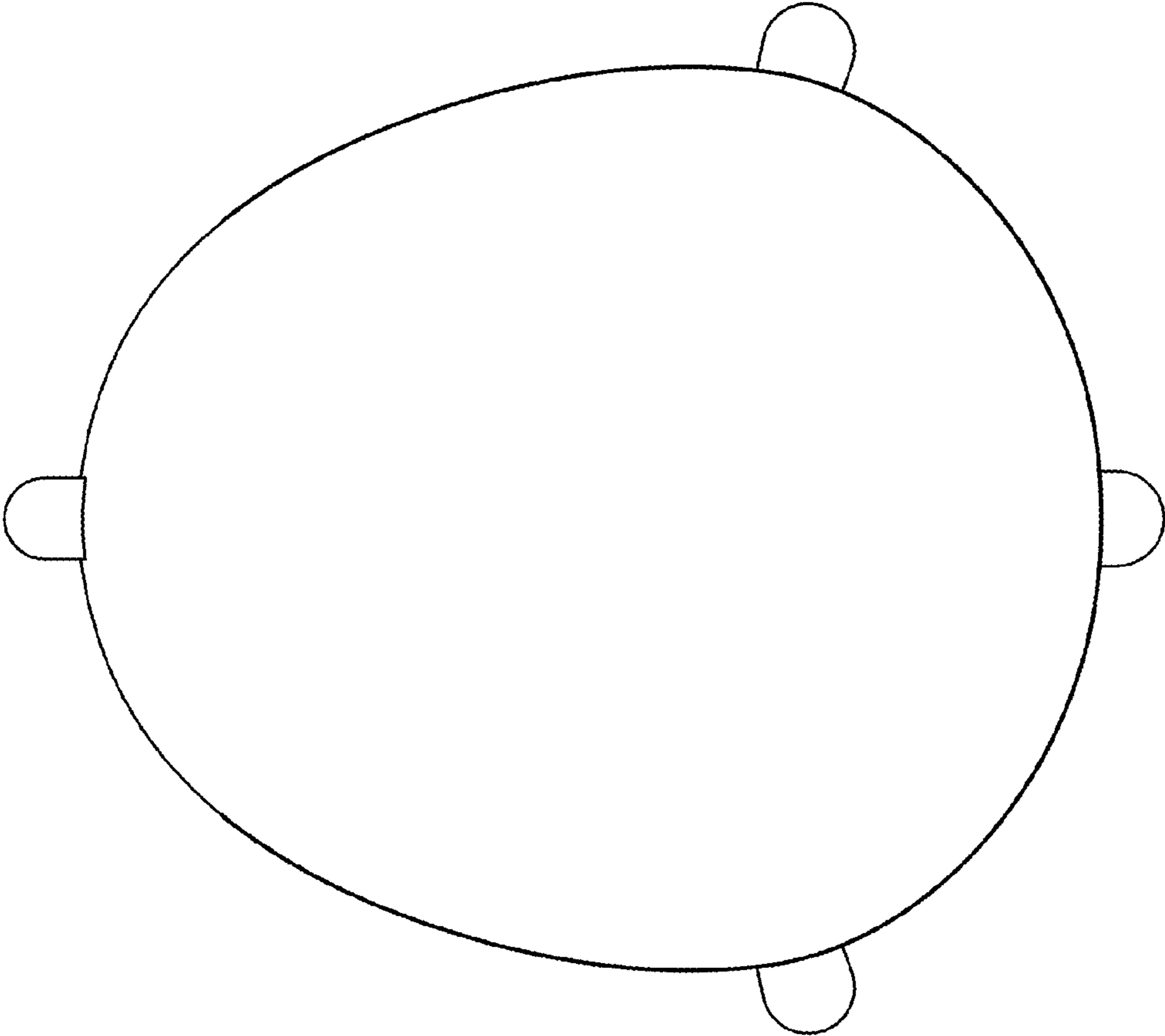

Figure 1

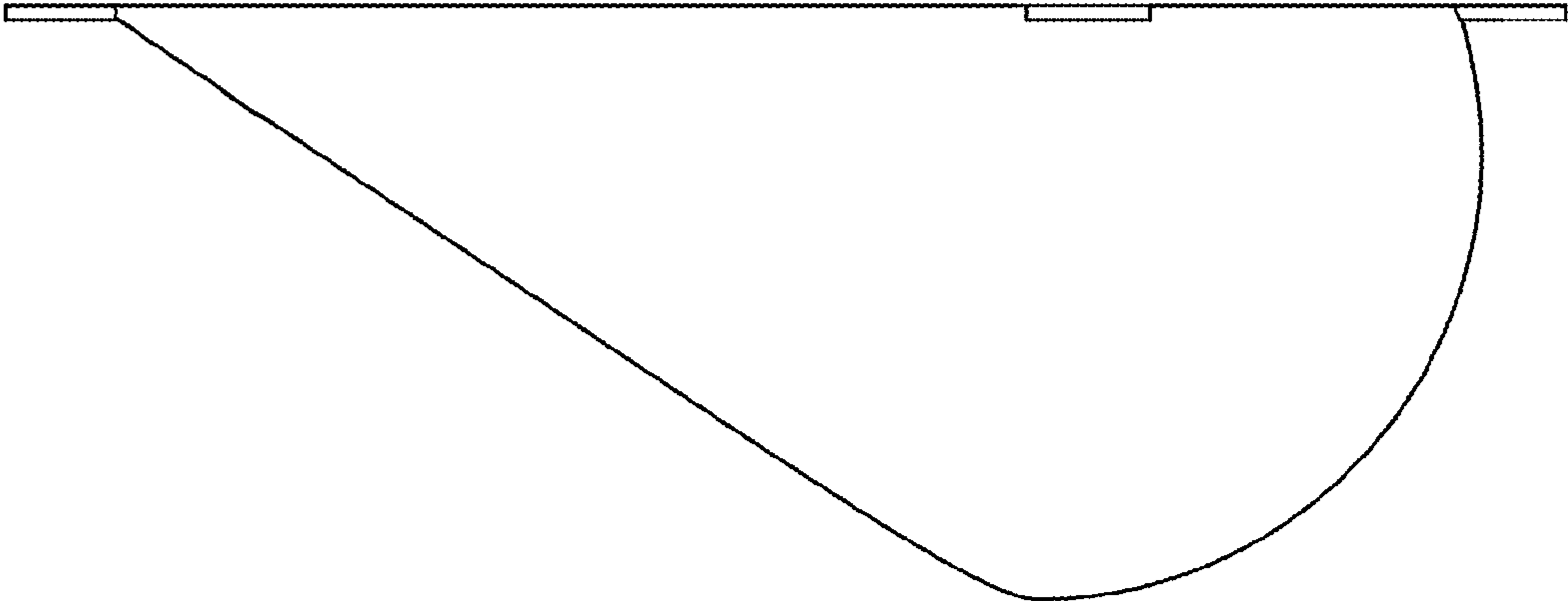

Figure 3

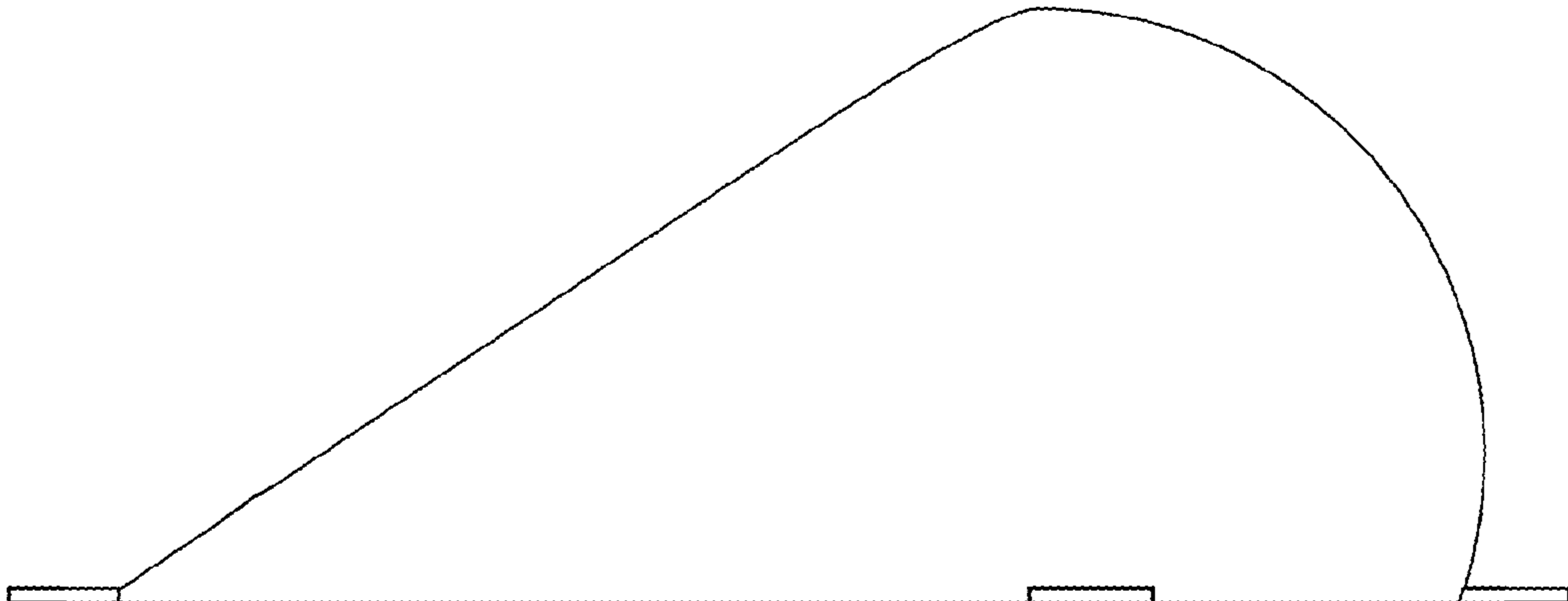

Figure 2

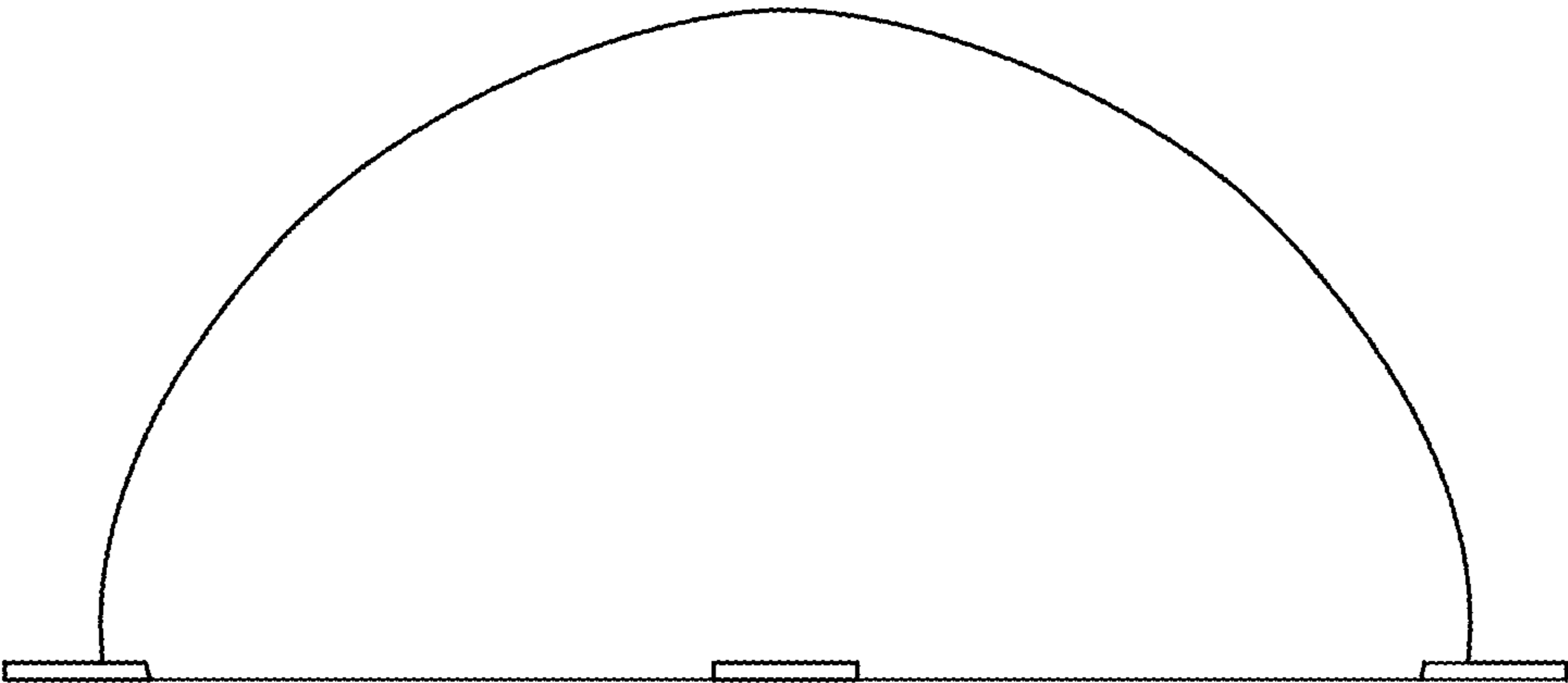

Figure 4

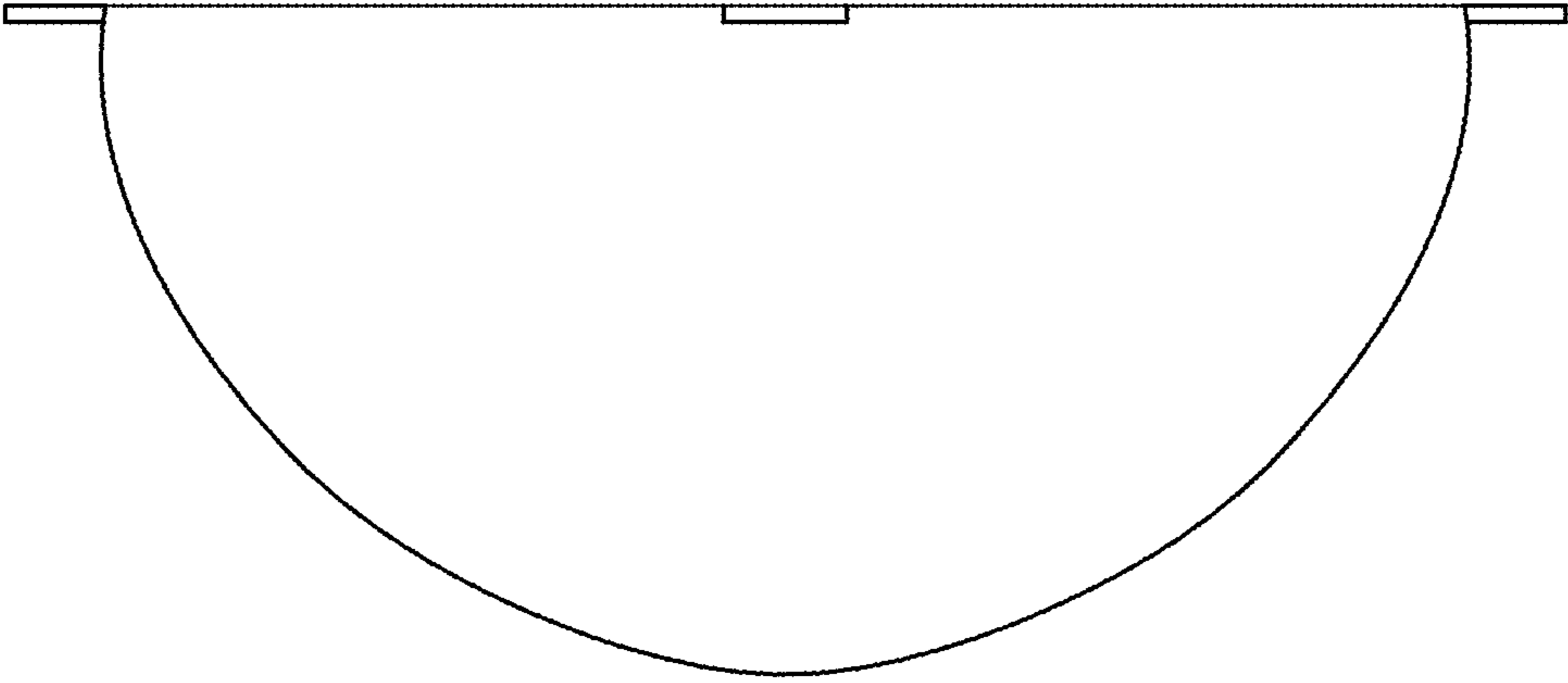

Figure 5

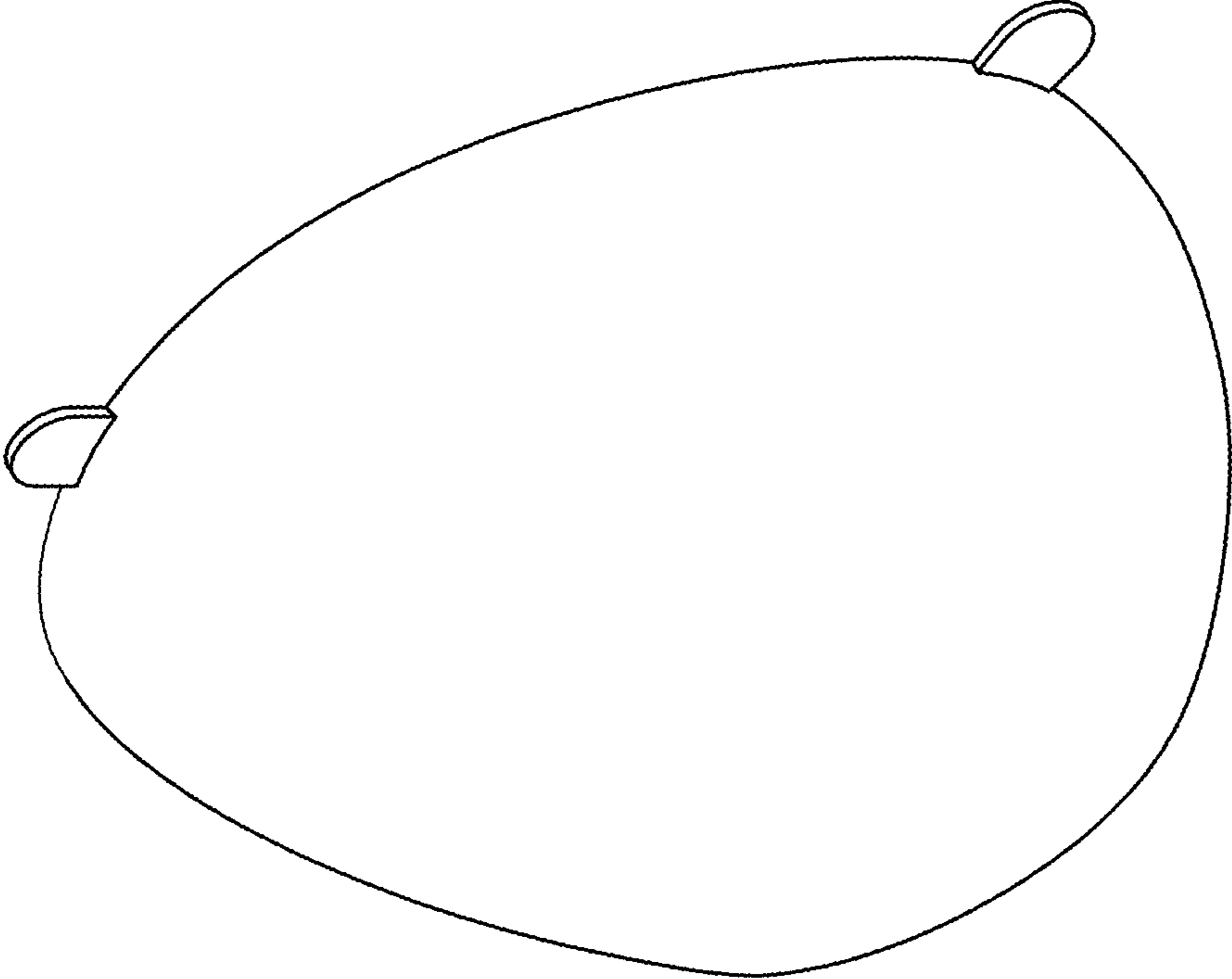

Figure 7

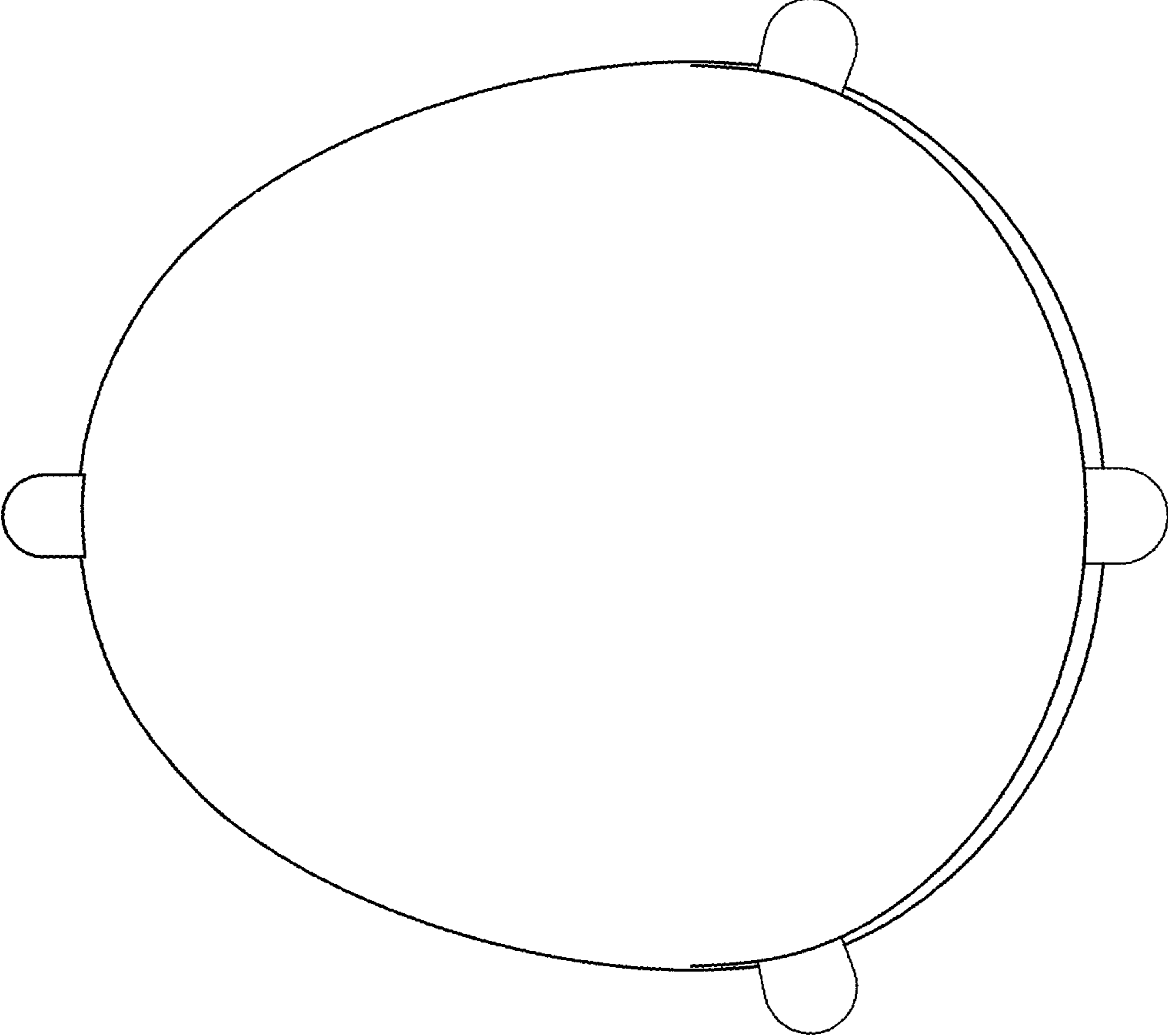

Figure 6