



US00D889600S

(12) **United States Design Patent** (10) **Patent No.:** **US D889,600 S**
Zhang (45) **Date of Patent:** **** Jul. 7, 2020**

(54) **SHOWER HEAD**
(71) Applicant: **Xinrui Zhang**, Kaiping (CN)
(72) Inventor: **Xinrui Zhang**, Kaiping (CN)
(**) Term: **15 Years**

(21) Appl. No.: **29/723,003**
(22) Filed: **Feb. 4, 2020**
(51) **LOC (12) Cl.** **23-01**
(52) **U.S. Cl.**
USPC **D23/213; D23/229**
(58) **Field of Classification Search**
USPC D23/213, 223, 249, 255, 257, 229, 230
CPC A47K 7/00; B05B 1/00; B05B 1/02; B05B
1/05; B05B 1/14; B05B 1/18; B05B
1/185
See application file for complete search history.

(56) **References Cited**
U.S. PATENT DOCUMENTS

D443,029 S	5/2001	Haug et al.	
D447,218 S	8/2001	Haug et al.	
D463,844 S	10/2002	Farley	
D471,253 S	3/2003	Tse	
D503,462 S *	3/2005	Ouyoung	D23/229
D544,944 S *	6/2007	Li	D23/213
D550,326 S	9/2007	Huang	
D583,015 S *	12/2008	Soriano	D23/249
D646,353 S *	10/2011	Yoo	D23/213
D753,792 S *	4/2016	Blum	D23/213
D758,552 S *	6/2016	Rexach	D23/255
D760,347 S *	6/2016	Hanna	D23/213
D774,162 S *	12/2016	Hanna	D23/213
D802,091 S *	11/2017	Bahler	D23/213
D805,611 S *	12/2017	Rexach	D23/257
D842,429 S *	3/2019	Huang	D23/213
D842,430 S *	3/2019	Huang	D23/213
D870,845 S *	12/2019	Eads	E03C 1/084 D23/213

D876,582 S *	2/2020	Eads	B05B 1/1618 D23/213
2013/0193237 A1 *	8/2013	Erickson	E03C 1/084 239/548
2016/0136659 A1 *	5/2016	Erickson	B05B 1/1618 239/443

OTHER PUBLICATIONS

Amazon.com, Imlezon Stainless Steel Kitchen Sink Faucet with Pull Down Sprayer, earliest review Aug. 2018, online product page, retrieved Apr. 7, 2020 from <URL:https://www.amazon.com/IMLEZON-Stainless-Kitchen-Faucet-Sprayer/dp/B07WRWTSHH#customerReviews> (Year: 2018).*

(Continued)

Primary Examiner — Sheryl Lane
Assistant Examiner — Calvin E Vansant
(74) *Attorney, Agent, or Firm* — KA Filing LLC; Wayne V. Harper

(57) **CLAIM**

I claim the ornamental design for a shower head, as shown and described.

DESCRIPTION

FIG. 1 is a perspective view of a shower head showing my new design;
FIG. 2 is other perspective view thereof;
FIG. 3 is a front view thereof;
FIG. 4 is a back view thereof;
FIG. 5 is a right-side view thereof;
FIG. 6 is a left-side view thereof; and,
FIG. 7 is a top view thereof.
The broken lines are only for environmental purposes and form no part of the claimed design.

1 Claim, 7 Drawing Sheets

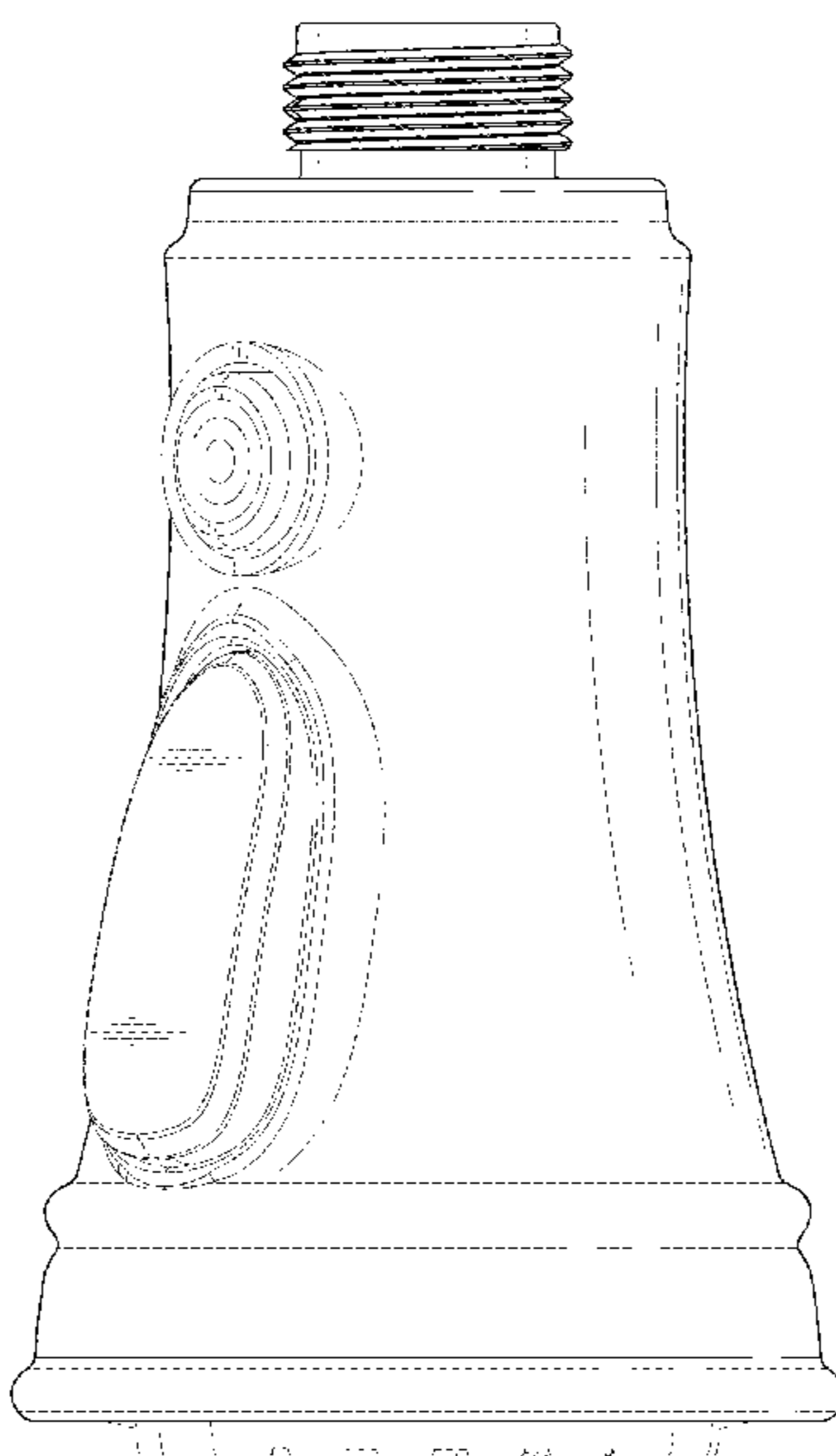

(56)

References Cited

OTHER PUBLICATIONS

Amazon.com, Moen 7185ORB Brantford One-Handle Pulldown Kitchen Faucet, review date Feb. 2016, online product page, retrieved Apr. 7, 2020 from <URL:https://www.amazon.com/Moen-7185ORB-Brantford-One-Handle-Featuring/dp/B00499UAXK> (Year: 2016).*

Kraus USA, KPF-3121SFS Transitional Bridge Faucet, Feb. 14, 2020, online product promotion post on Instagram, retrieved Apr. 7, 2020 from <URL:https://www.instagram.com/p/B8jkXojAzeU/> (Year: 2020).*

* cited by examiner

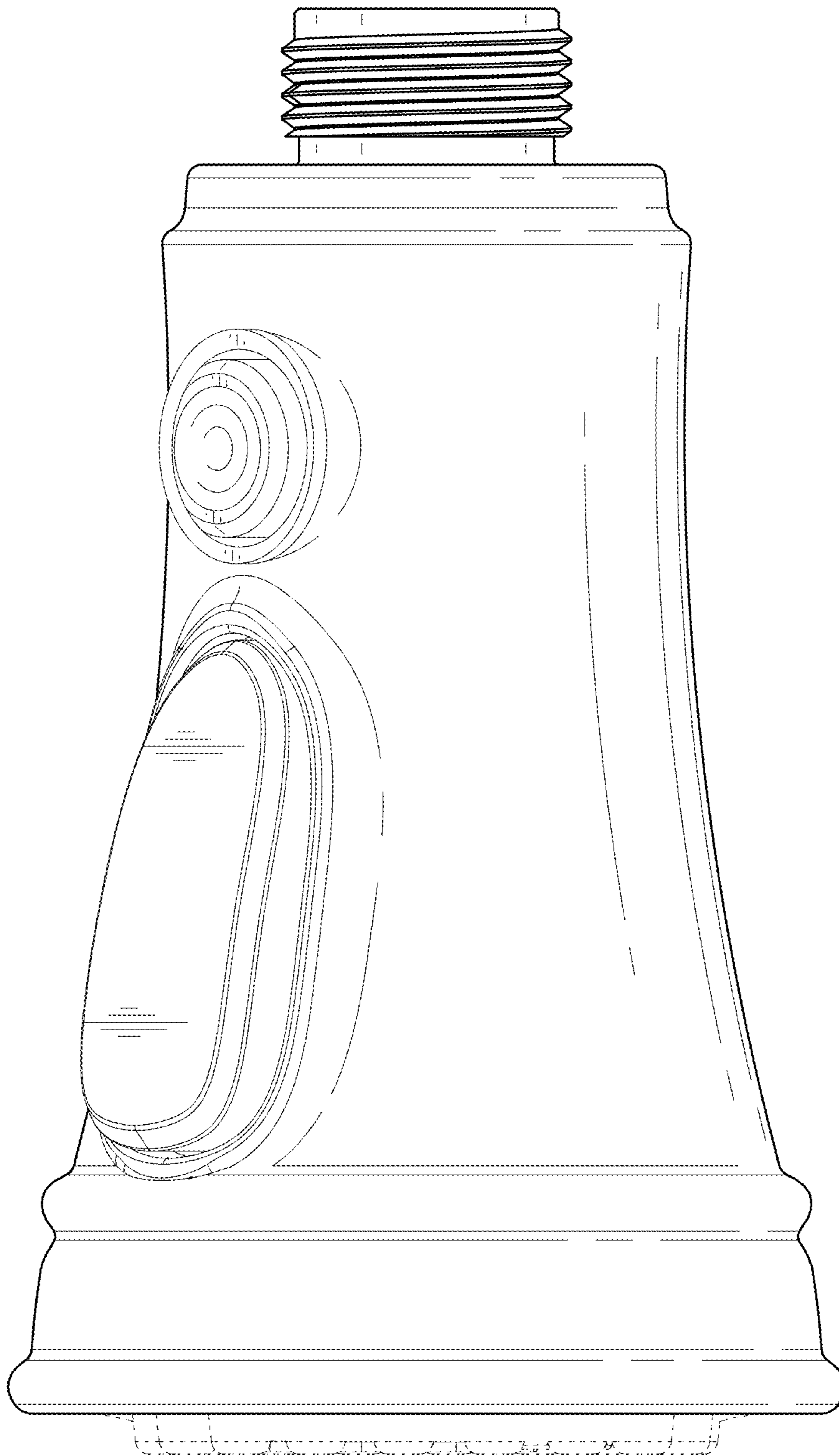

FIG. 1

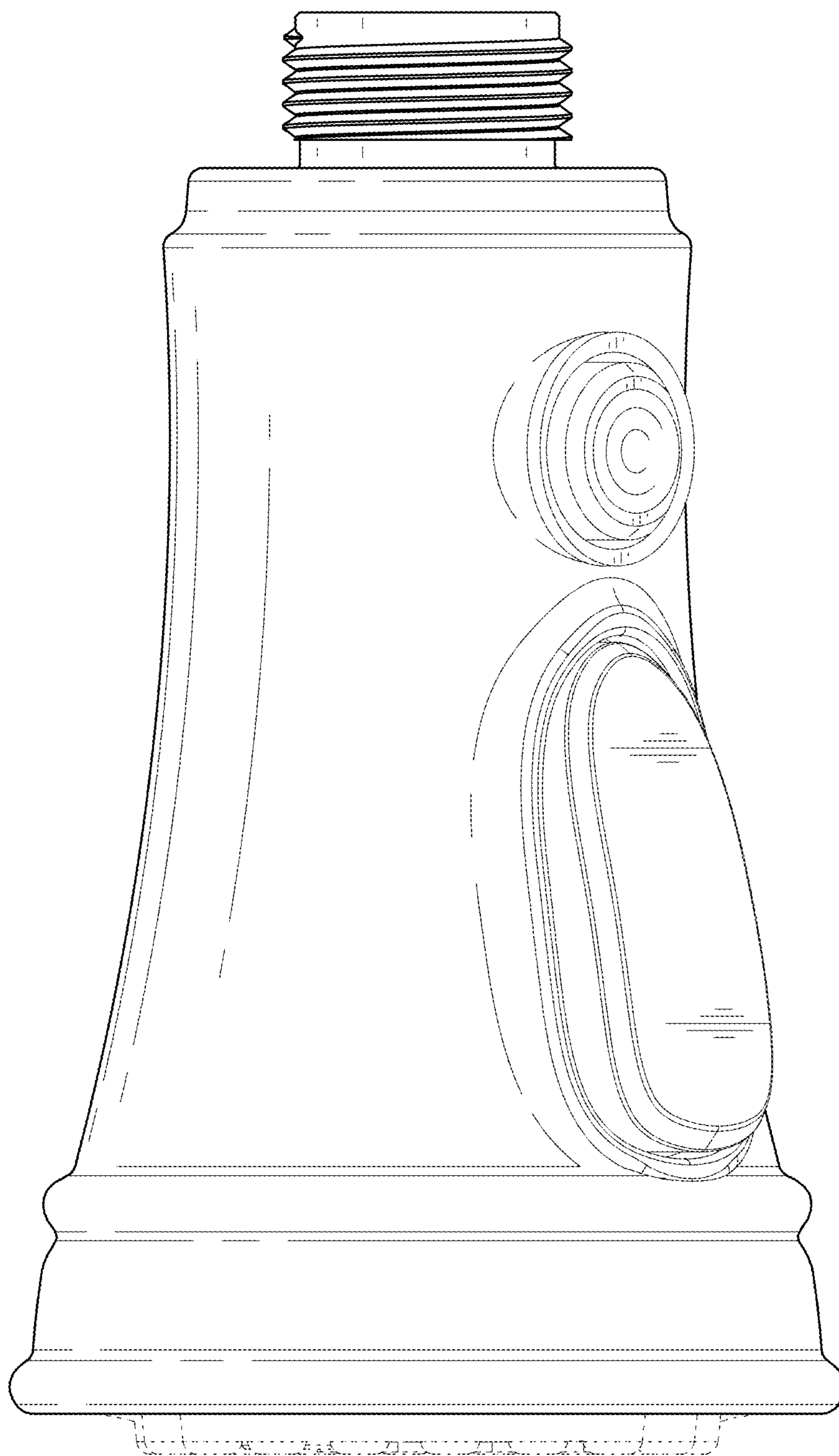

FIG. 2

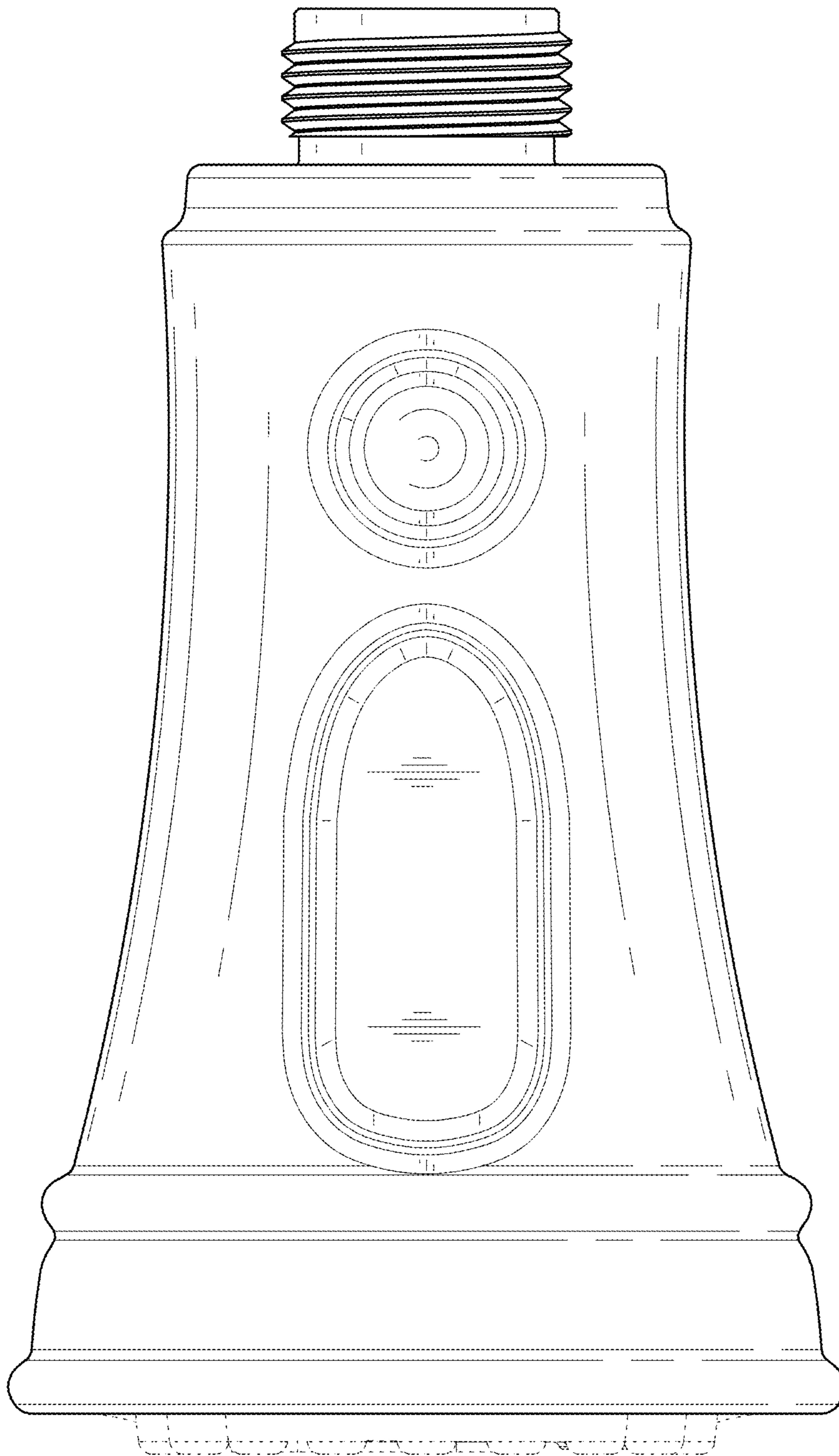

FIG. 3



FIG. 4

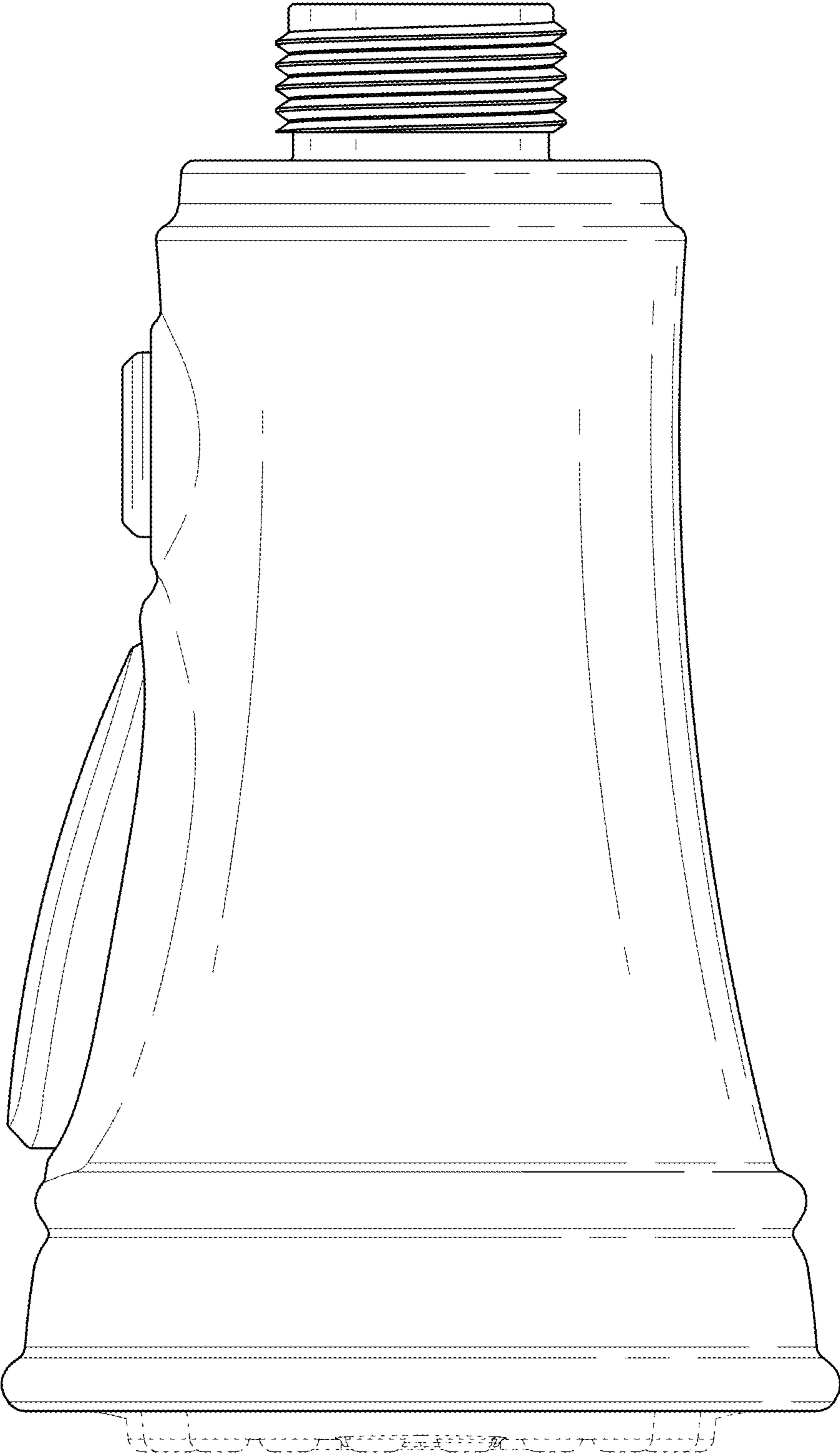

FIG. 5

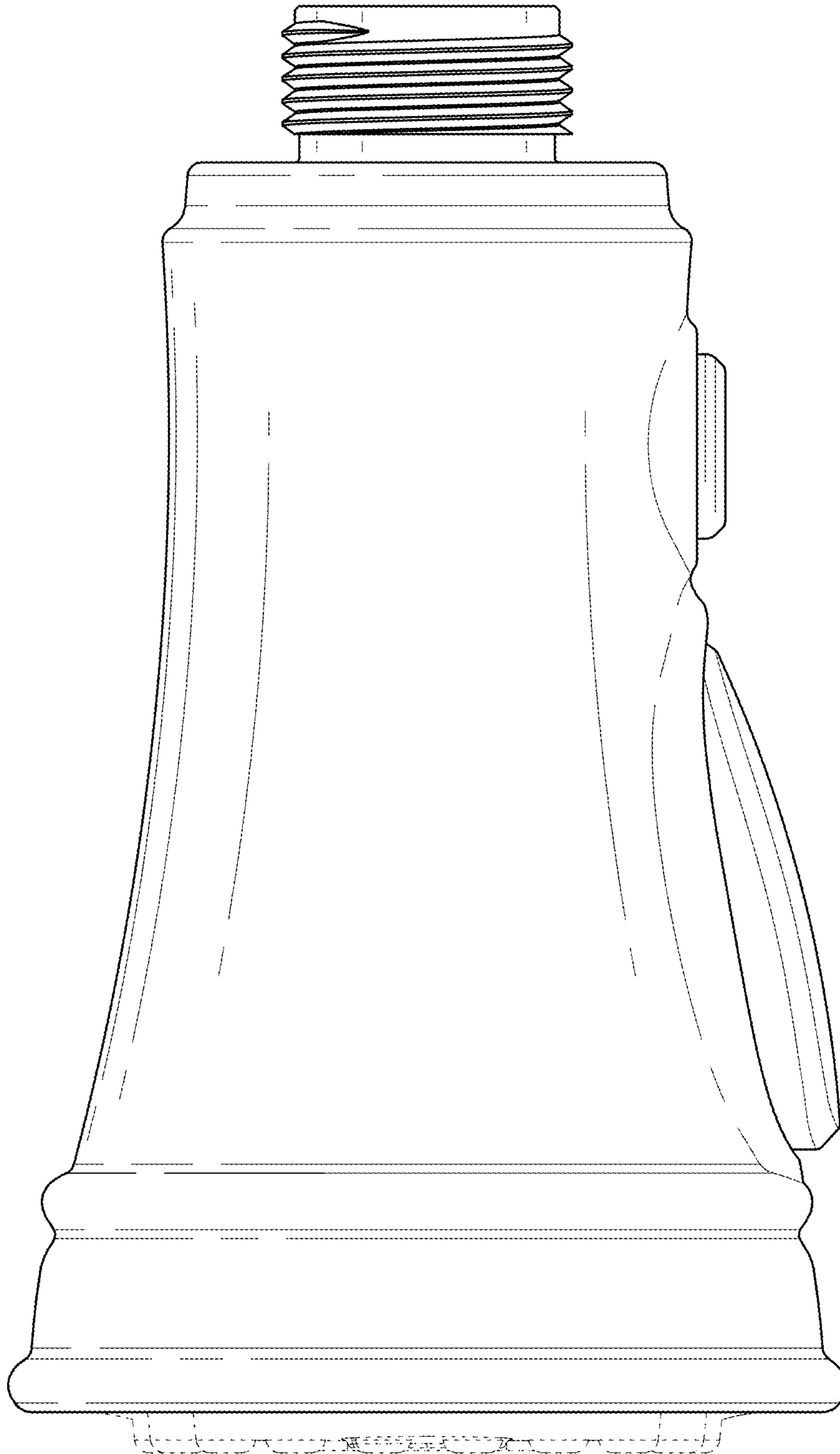

FIG. 6

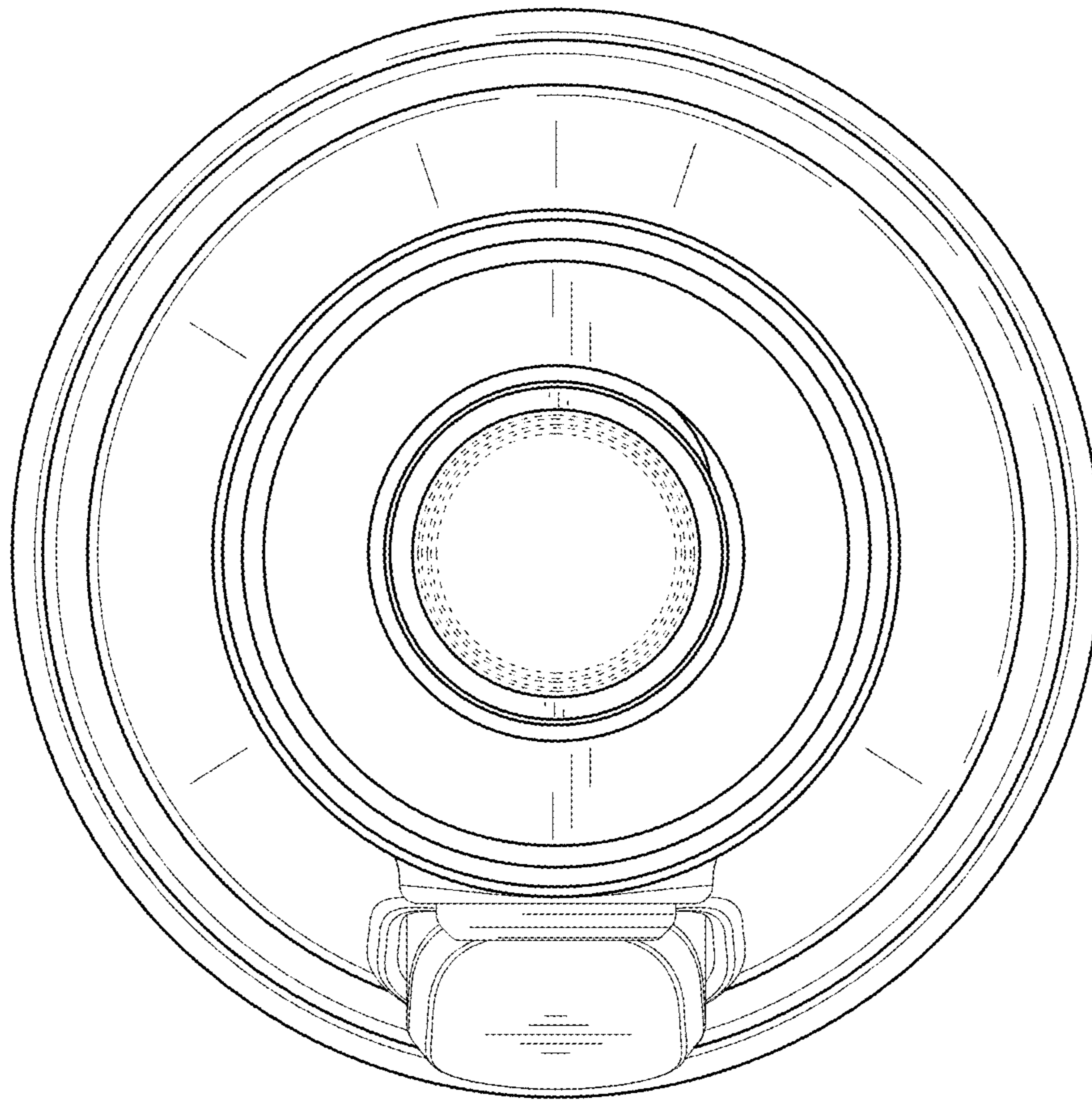

FIG. 7