



US00D889474S

(12) **United States Design Patent** (10) **Patent No.:** **US D889,474 S**
Akana et al. (45) **Date of Patent:** **** Jul. 7, 2020**

(54) **CASE**

(71) Applicant: **Apple Inc.**, Cupertino, CA (US)

(72) Inventors: **Jody Akana**, San Francisco, CA (US); **Bartley K. Andre**, Palo Alto, CA (US); **Shota Aoyagi**, San Francisco, CA (US); **Jeremy Bataillou**, San Francisco, CA (US); **Daniel J. Coster**, San Francisco, CA (US); **Daniele De Iuliis**, San Francisco, CA (US); **M. Evans Hankey**, San Francisco, CA (US); **Julian Hoenig**, San Francisco, CA (US); **Richard P. Howarth**, San Francisco, CA (US); **Duncan Robert Kerr**, San Francisco, CA (US); **Matthew Dean Rohrbach**, San Francisco, CA (US); **Peter Russell-Clarke**, San Francisco, CA (US); **Mikael Silvanto**, San Francisco, CA (US); **Christopher J. Stringer**, Woodside, CA (US); **Eugene Antony Whang**, San Francisco, CA (US); **Rico Zörkendörfer**, San Francisco, CA (US)

(73) Assignee: **Apple Inc.**, Cupertino, CA (US)

(*) Notice: This patent is subject to a terminal disclaimer.

(**) Term: **15 Years**

(21) Appl. No.: **29/645,886**

(22) Filed: **Apr. 30, 2018**

Related U.S. Application Data

(63) Continuation of application No. 29/534,235, filed on Jul. 27, 2015, now Pat. No. Des. 816,677, which is a (Continued)

(51) **LOC (12) Cl.** **14-03**

(52) **U.S. Cl.**
USPC **D14/440**

(58) **Field of Classification Search**

USPC ... D14/250, 251, 253, 240, 217, 496, 203.3, D14/203.4, 203.5, 203.8, 440, 238.1, 432, (Continued)

(56) **References Cited**

U.S. PATENT DOCUMENTS

2,968,176 A 1/1961 Collings
3,442,371 A 5/1969 Deshong et al.
(Continued)

FOREIGN PATENT DOCUMENTS

EM 001266266-000 3/2011
EM 001266282-000 3/2011
(Continued)

OTHER PUBLICATIONS

Incase, "Introducing the Convertible Magazine Jacket for iPad", goincase.com, accessed at <http://goincase.com/blog/2010/11/23/introducing-the-convertible-magazine-jacket-for-ipad/>, dated Nov. 23, 2010, 7 pages.

(Continued)

Primary Examiner — Holly E Thurman

(74) *Attorney, Agent, or Firm* — Sterne, Kessler, Goldstein & Fox P.L.L.C.

(57) **CLAIM**

The ornamental design for a case, as shown and described.

DESCRIPTION

FIG. 1 is a bottom front perspective view of a case showing the claimed design;

FIG. 2 is a front view thereof;

FIG. 3 is a rear view thereof;

FIG. 4 is a left side view thereof;

FIG. 5 is a right side view thereof;

FIG. 6 is a top view thereof;

FIG. 7 is a bottom view thereof;

(Continued)

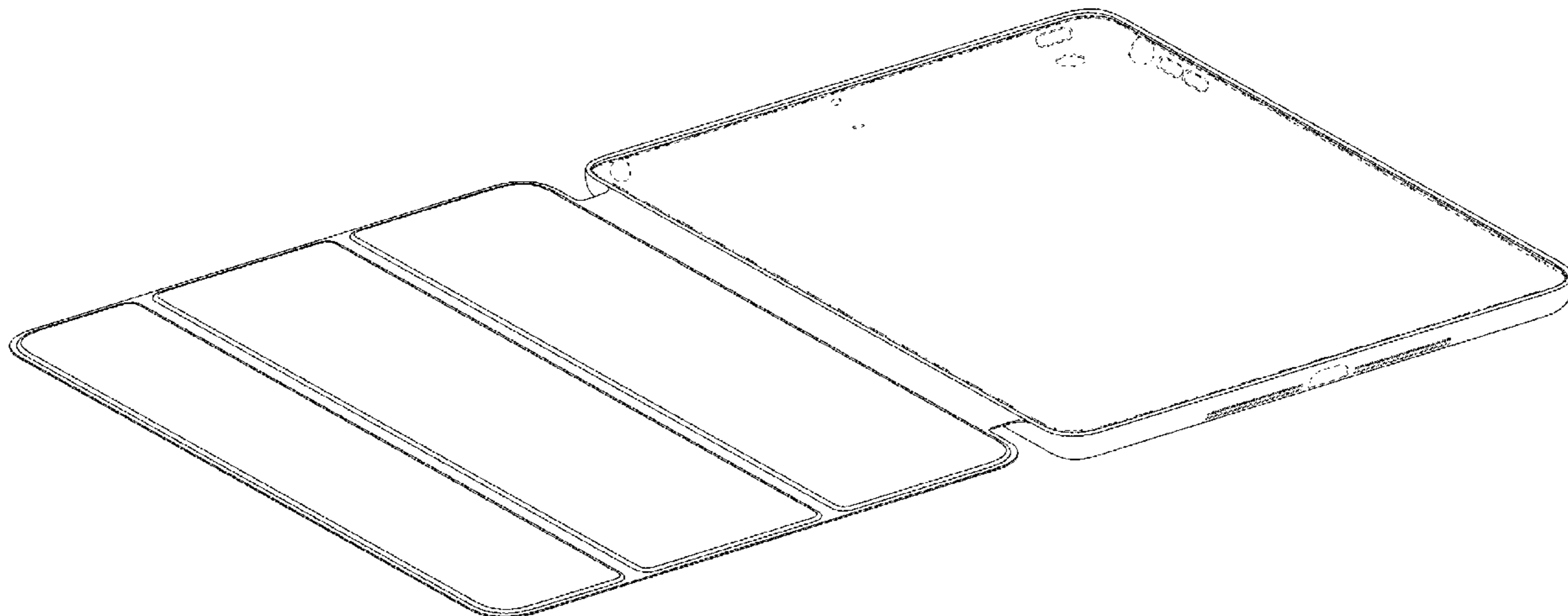

FIG. 8 is a cross-sectional view taken along line 8-8 in FIG. 2;
 FIG. 9 is a bottom front perspective view of another embodiment of a case showing the claimed design;
 FIG. 10 is a front view thereof;
 FIG. 11 is a rear view thereof;
 FIG. 12 is a left side view thereof;
 FIG. 13 is a right side view thereof;
 FIG. 14 is a top view thereof;
 FIG. 15 is a bottom view thereof; and,
 FIG. 16 is a cross-sectional view taken along line 16-16 in FIG. 10.

The dashed broken lines in the figures show portions of the case that form no part of the claimed design.
 The dot-dash broken lines in the figures and the areas within the dot-dash broken lines show portions of the case that form no part of the claimed design.
 The cross-hatched shading in FIGS. 8 and 16 forms no part of the claimed design.

1 Claim, 10 Drawing Sheets

Related U.S. Application Data

continuation of application No. 29/470,472, filed on Oct. 22, 2013, now Pat. No. Des. 735,205.

(58) **Field of Classification Search**

USPC D14/439, 300; D3/201, 273, 274, 290, D3/294, 300-303, 315, 318, 319, D3/323-328

CPC H05K 5/023; G06F 1/1626
 See application file for complete search history.

(56) **References Cited**

U.S. PATENT DOCUMENTS

4,718,550 A	1/1988	Johnson
D321,855 S	11/1991	Ross, Jr.
5,066,158 A	11/1991	Huang
5,092,354 A	3/1992	Pacelli, Jr.
D331,191 S	11/1992	Ventola et al.
D364,191 S	11/1995	Allen
D409,667 S	5/1999	Riley et al.
D454,110 S	3/2002	Andre et al.
D467,429 S	12/2002	Bone et al.
D512,100 S	11/2005	Howes et al.
D538,096 S	3/2007	Bartell et al.
D556,681 S	12/2007	Kim
D574,819 S	8/2008	Andre et al.
D582,405 S	12/2008	Andre et al.
D583,479 S	12/2008	Yim
D584,141 S	1/2009	Smith et al.
D606,751 S	12/2009	Andre et al.
7,697,281 B2	4/2010	Dabov et al.
D619,361 S	7/2010	Andre et al.
D622,716 S	8/2010	Andre et al.
D627,777 S	11/2010	Akana et al.
D633,388 S	3/2011	Andre et al.
D637,814 S	5/2011	Akana et al.
D656,495 S	3/2012	Andre et al.
8,143,982 B1	3/2012	Lauder et al.
D658,186 S	4/2012	Akana et al.
D658,187 S	4/2012	Diebel
D658,188 S	4/2012	Diebel
D662,100 S	6/2012	Van Den Nieuwenhuizen et al.

D662,503 S	6/2012	Akana et al.	
D670,692 S	11/2012	Akana et al.	
8,328,008 B2	12/2012	Diebel et al.	
D685,801 S	7/2013	Canizares et al.	
D685,803 S	7/2013	Akana et al.	
D688,251 S	8/2013	Akana et al.	
D691,142 S	10/2013	Diebel	
D691,143 S	10/2013	Diebel	
D704,702 S *	5/2014	Akana	D14/341
D706,270 S *	6/2014	Akana	D14/440
D708,836 S *	7/2014	Lee	D14/440
8,794,436 B2	8/2014	Hsu	
D740,292 S *	10/2015	Akana	D14/440
D750,632 S *	3/2016	Diebel	D14/440
D773,454 S *	12/2016	Akana	D14/341
D776,122 S *	1/2017	Akana	D14/440
D776,123 S *	1/2017	Akana	D14/440
D779,485 S *	2/2017	Akana	D14/345
D784,995 S *	4/2017	Akana	D14/440
D788,104 S	5/2017	Akana et al.	
D795,860 S	8/2017	Rak et al.	
D795,864 S *	8/2017	Akana	D14/344
D795,880 S *	8/2017	Akana	D14/440
D795,881 S	8/2017	Akana et al.	
D800,711 S	10/2017	Kim	
D801,323 S	10/2017	Kim	
D819,038 S *	5/2018	Diebel	D14/440
D820,838 S *	6/2018	Akana	D14/345
D857,023 S *	8/2019	Hyun	D14/440
2009/0107858 A1	4/2009	Huang	
2009/0194209 A1	8/2009	De Filippis et al.	
2010/0289390 A1	11/2010	Kenney	
2010/0300909 A1	12/2010	Hung	
2011/0164365 A1	7/2011	McClure et al.	
2011/0227463 A1	9/2011	Hou et al.	
2011/0299231 A1	12/2011	Gaddis, II et al.	
2012/0140396 A1	6/2012	Zeliff et al.	
2012/0194448 A1	8/2012	Rothkopf	

FOREIGN PATENT DOCUMENTS

EM	001266290-000	3/2011
GB	4020173	6/2011
TW	D154071 S	6/2013

OTHER PUBLICATIONS

Case-Parts, "Original Targus Folding Genuine Leather Case for Apple iPad with Built-in Holder," <http://www.case-parts.com/details/Original-Targus-Folding-Genuine-Leather-Case-for-Apple-iPad-with-Built-in-Holder-IPAD-570/photos.htm>, 3 pages.
 "Review: AViiQ Smart Case for iPad 2", which was published on YouTube at <http://www.youtube.com/watch?v=DaHjzeVWEuA>, May 24, 2011, 3 pages.
 "AViiQ Smart Case for iPad 2 compliments Apple's Smart Cover (Review)", which was published on YouTube at <http://www.youtube.com/watch?v=wMoZM-ZSn4g>, Aug. 31, 2011, 2 pages.
 Youtube.com, "iPad 2 — Best Protective Case — Smart Cover + Smart Back Cover by Simplism", <http://www.youtube.com/watch?v=SRHhU98NAdO&feature=endscreen&Nr=1>), May 15, 2011.
 "The First iPad 2 Smart Cover Clones are Here", which was published on GIZMODO.com at <http://gizmodo.com/5782270/the-first-ipad-2-smart-cover-clones-are-here>, Mar. 15, 2011, 2 pages.
<http://blog.scoopz.com/2011/07/15/cool-bananas-smartshell-ipad-2-case-review/>; Cool Bananas SmartShell Case, Jul. 2011.
http://www.amazon.com/Fintie-iPad-mini-Retina-Display/dp/B009T4K9BS/ref=sr_1_22?s=electronics&ie=UTF8&qid=1410209701&sr=1-22&keywords=fintie=case;FintieSmartShellCase, Aug. 2012.

* cited by examiner

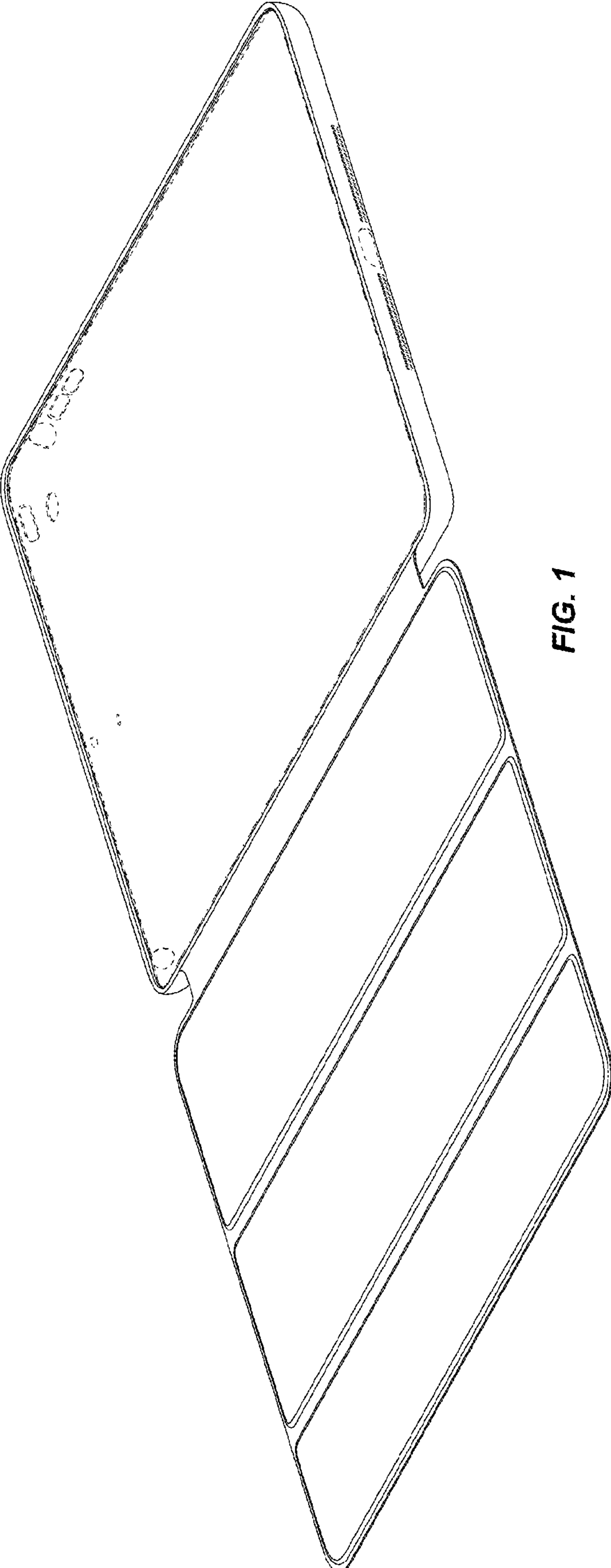

FIG. 1

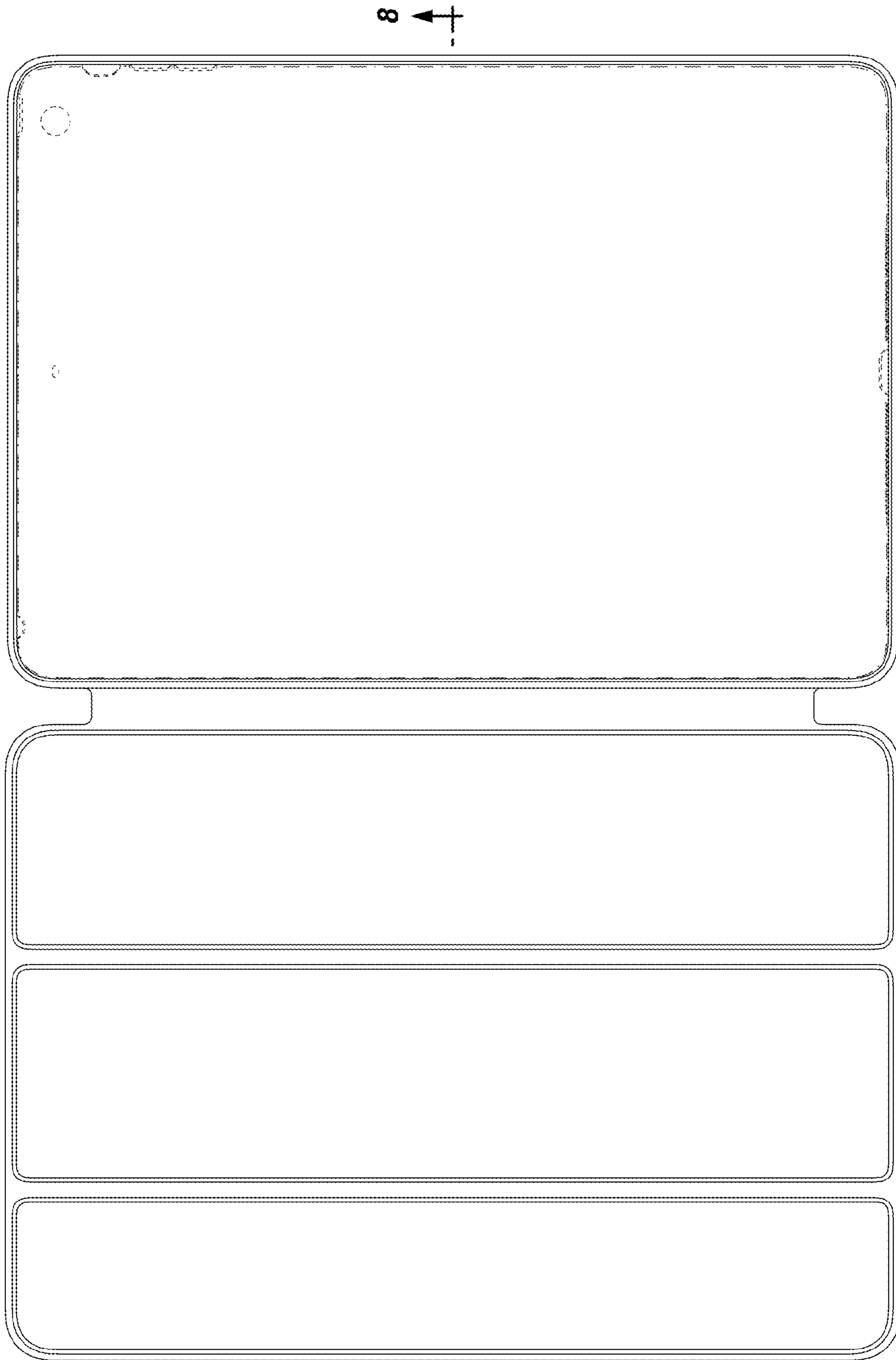

FIG. 2

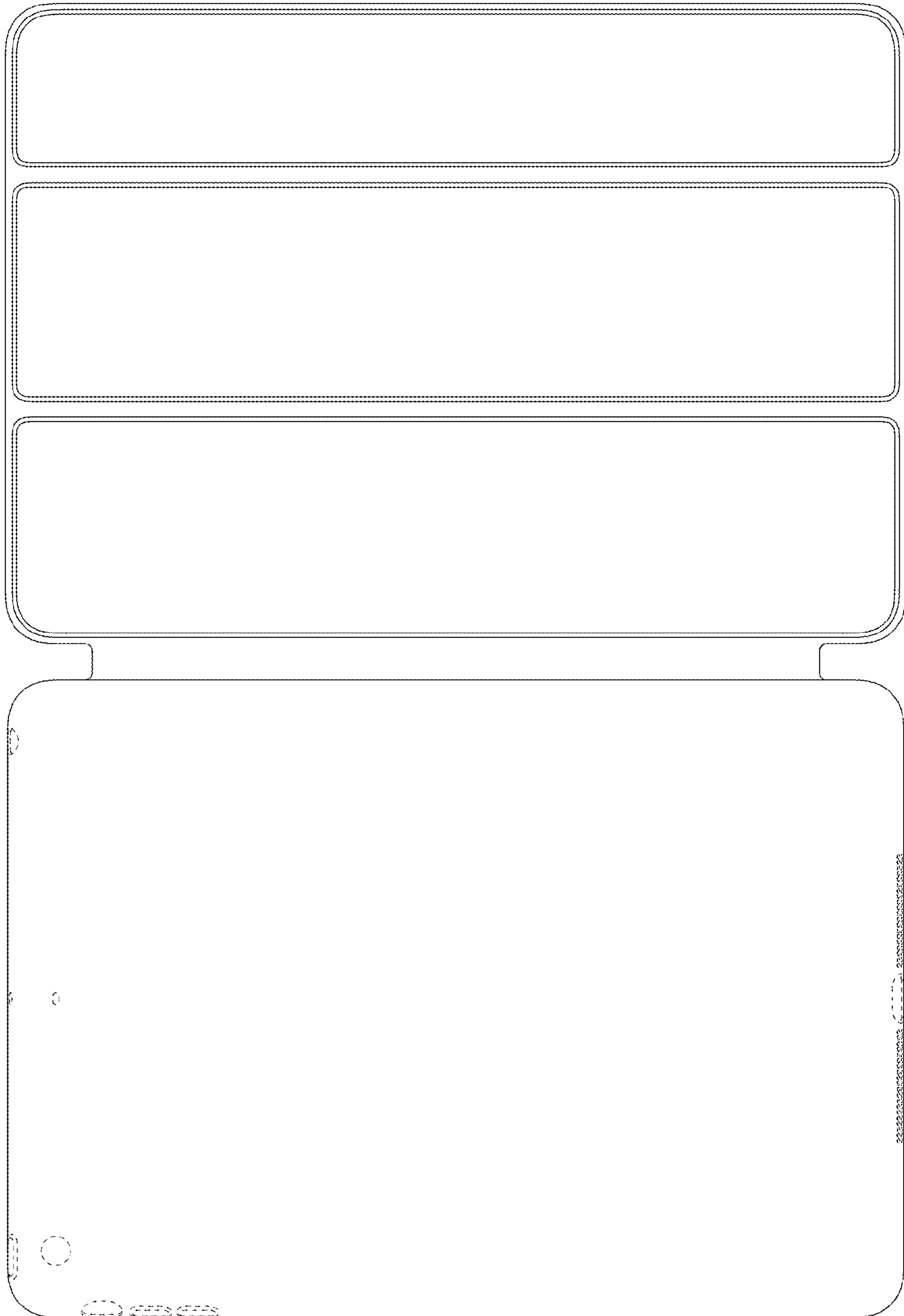

FIG. 3



FIG. 5

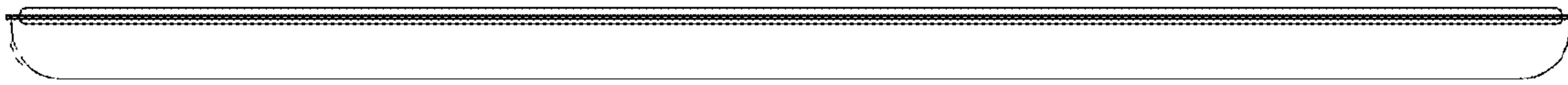

FIG. 4

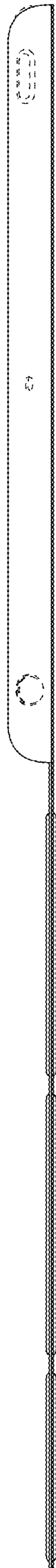

FIG. 6

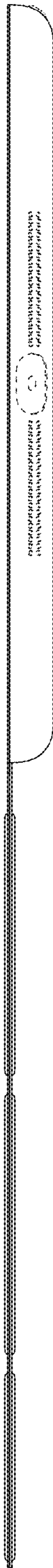

FIG. 7

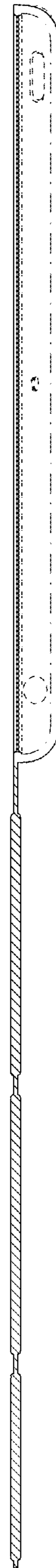

FIG. 8

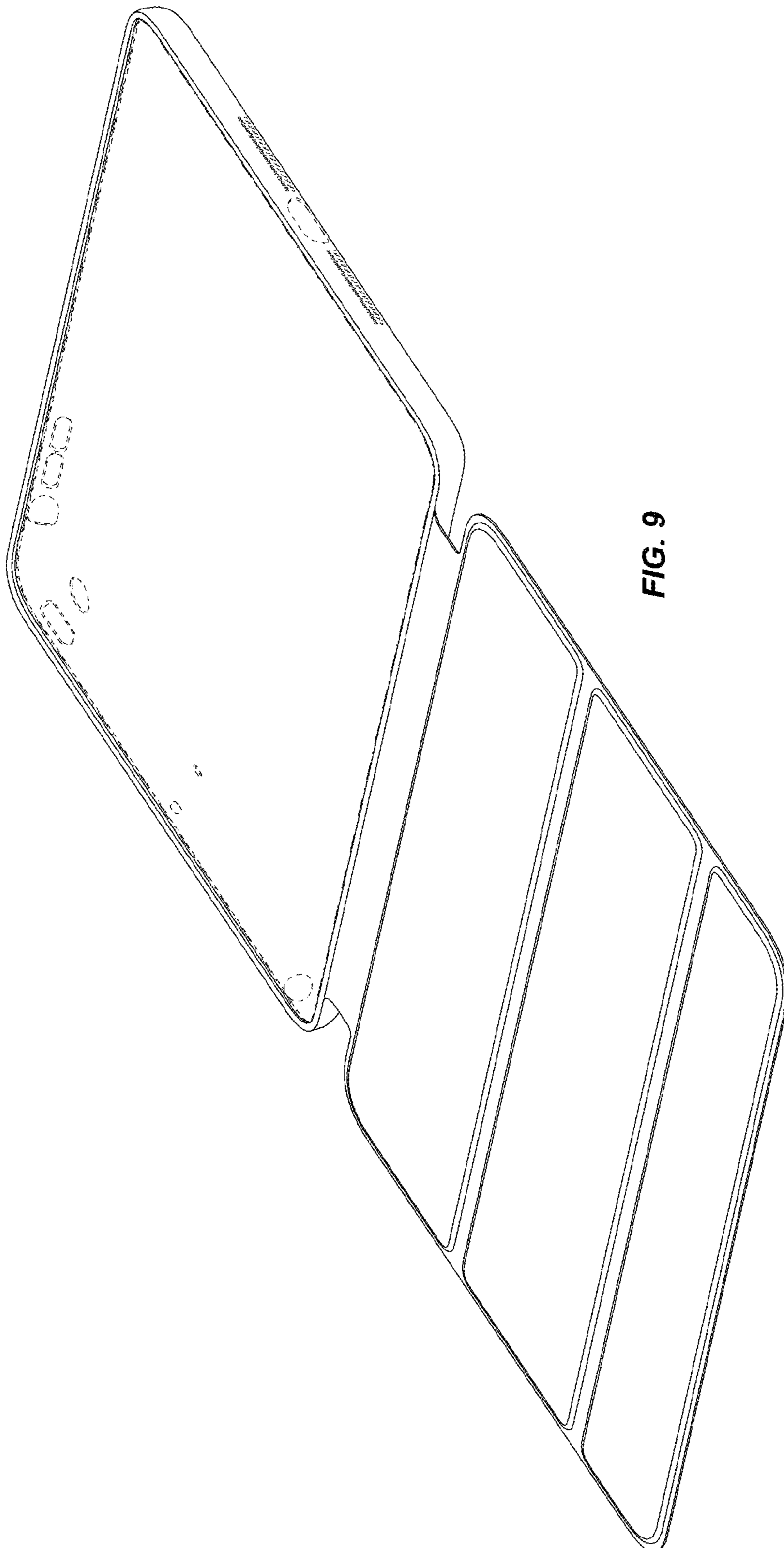

FIG. 9

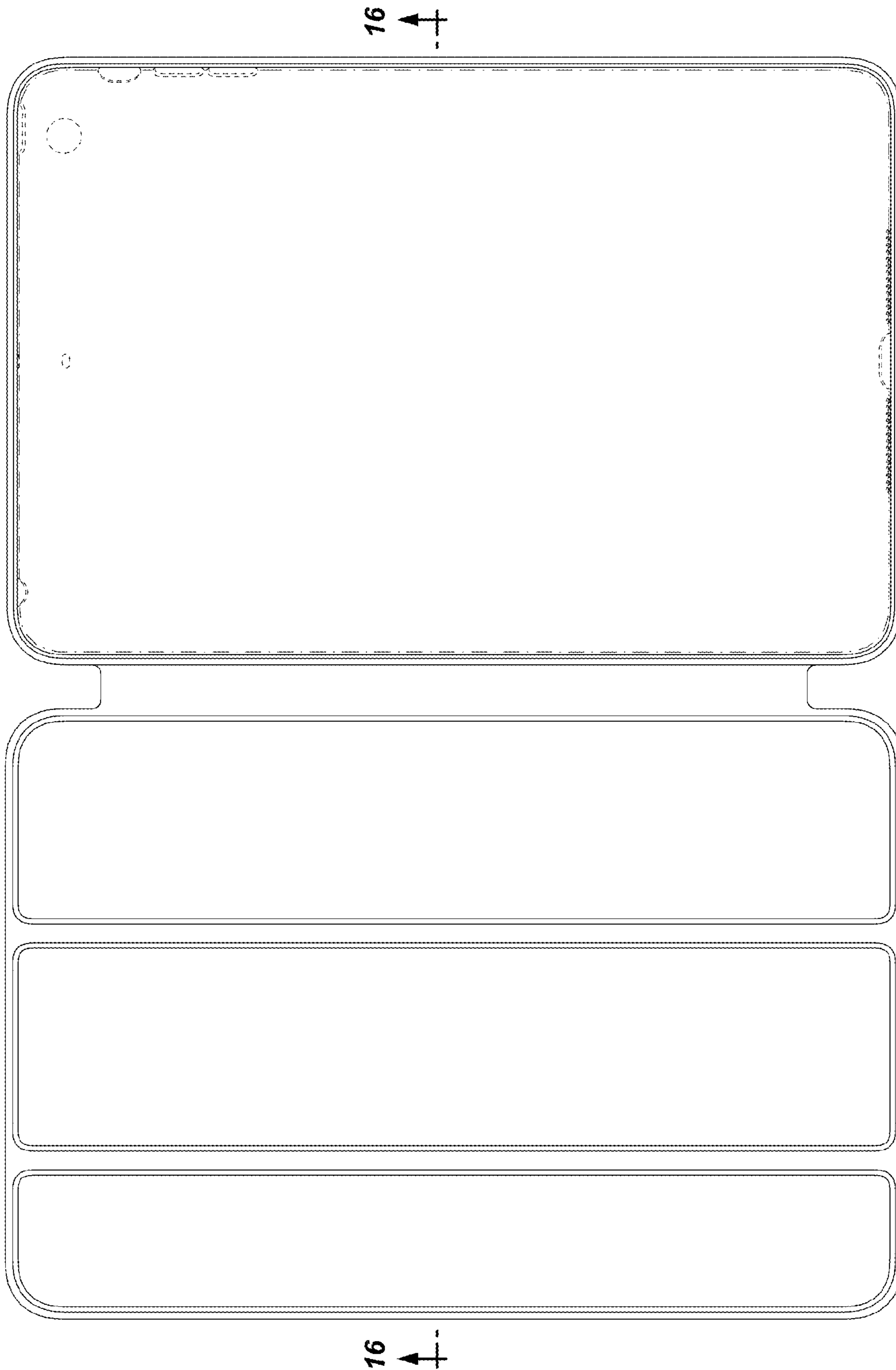

FIG. 10

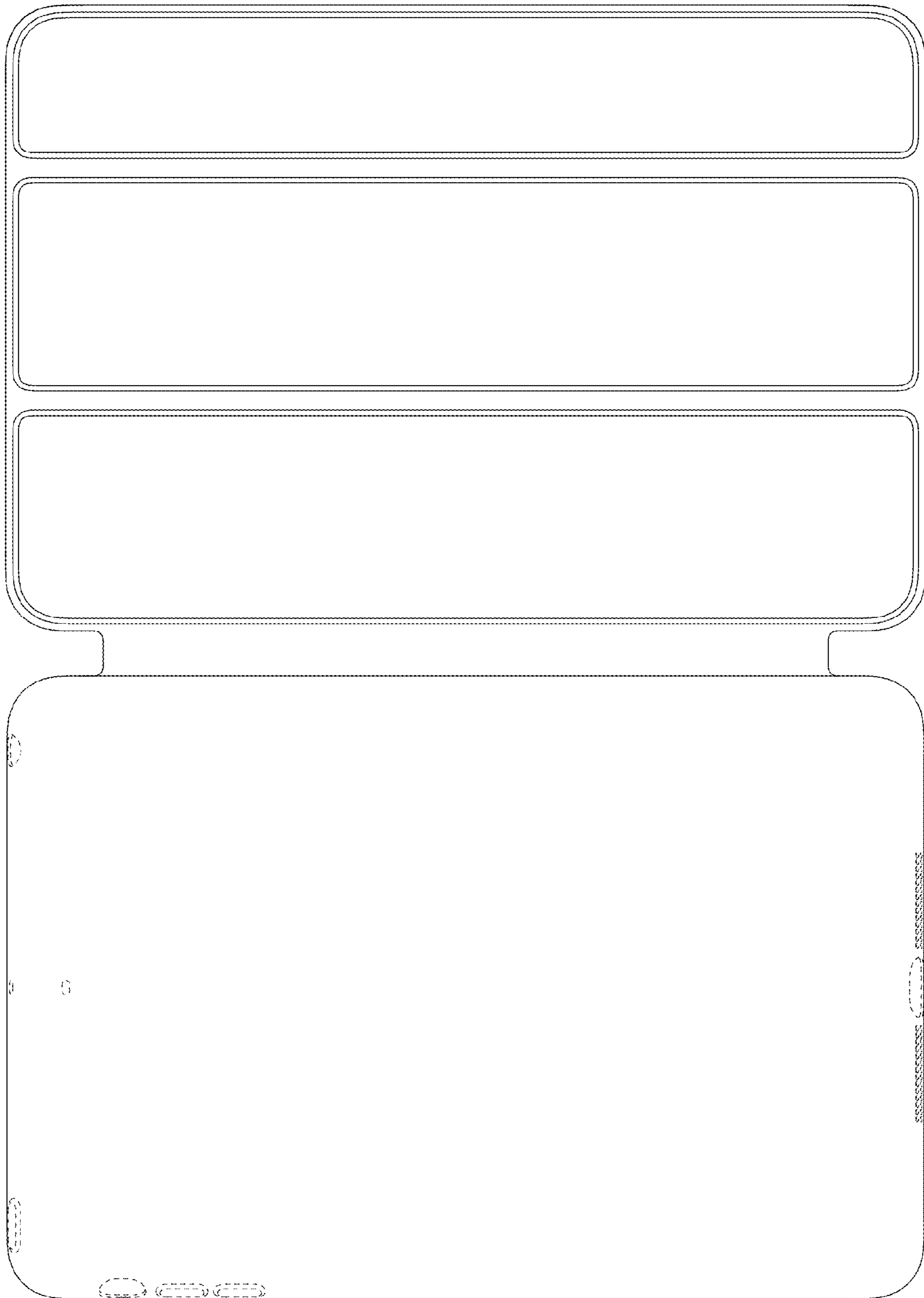

FIG. 11



FIG. 13

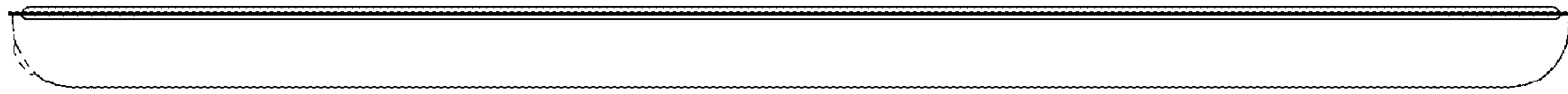

FIG. 12

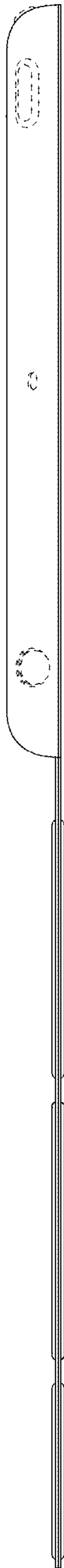

FIG. 14

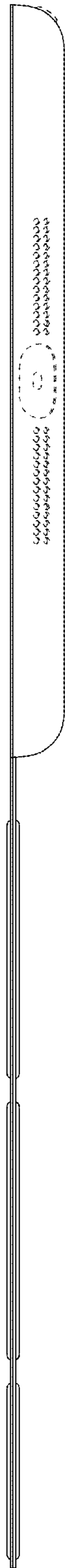

FIG. 15

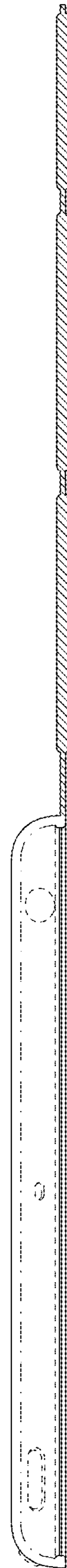

FIG. 16