



US00D889464S

(12) **United States Design Patent**  
**Wang et al.**

(10) **Patent No.:** **US D889,464 S**  
(45) **Date of Patent:** **\*\* Jul. 7, 2020**

(54) **STRAP FOR HEAD MOUNTED DISPLAY**  
(71) Applicant: **XRSPACE CO., LTD.**, Taoyuan (TW)  
(72) Inventors: **Chieh-Kai Wang**, Taichung (TW);  
**Yen-Hung Lin**, Taoyuan (TW)  
(73) Assignee: **XRSPACE CO., LTD.**, Taoyuan (TW)  
(\*\*) Term: **15 Years**  
(21) Appl. No.: **29/696,498**

10,338,637 B1 \* 7/2019 Bristol ..... G06F 1/163  
D869,464 S \* 12/2019 Chang ..... D14/372  
2018/0196485 A1 \* 7/2018 Cheng ..... H05K 7/20963  
2018/0335632 A1 \* 11/2018 Cho ..... G02B 7/002

**FOREIGN PATENT DOCUMENTS**

CN 303738967 7/2016  
CN 304450086 1/2018  
CN 304767768 8/2018  
CN 304848396 10/2018  
TW D196244 3/2019

\* cited by examiner

*Primary Examiner* — Katie Jane Stofko

(74) *Attorney, Agent, or Firm* — JCIP Global Inc.

(22) Filed: **Jun. 28, 2019**  
(51) **LOC (12) Cl.** ..... **14-02**  
(52) **U.S. Cl.**  
USPC ..... **D14/372**  
(58) **Field of Classification Search**  
USPC ..... D14/125, 126, 129, 299, 372, 432, 448,  
D14/451, 496; D16/300–342; 351/144,  
351/158, 153; 345/7–9, 905; 455/344;  
348/53, 115, 121, 739  
CPC ..... G02B 27/017; G02B 27/0158; G02B  
27/0161; G02B 27/0181; G02B 27/0185;  
G02B 27/0189  
See application file for complete search history.

(57) **CLAIM**

The ornamental design for a strap for head mounted display, as shown and described.

**DESCRIPTION**

FIG. 1 is a perspective view of a strap for head mounted display showing our new design;  
FIG. 2 is another perspective view thereof;  
FIG. 3 is a front view thereof;  
FIG. 4 is a rear view thereof;  
FIG. 5 is a left side view thereof;  
FIG. 6 is a right side view thereof;  
FIG. 7 is a top view thereof;  
FIG. 8 is a bottom view thereof; and,  
FIG. 9 is a perspective view thereof, shown in an environment of use.

The dashed broken lines in FIG. 9 illustrate the head mounted display and form no part of the claimed design.

(56) **References Cited**

**U.S. PATENT DOCUMENTS**

D356,796 S \* 3/1995 Jones ..... D14/239  
D398,403 S \* 9/1998 Bishop ..... D24/231  
D503,499 S \* 3/2005 Howard ..... D29/122  
D780,753 S \* 3/2017 Park ..... D14/372  
9,857,839 B1 \* 1/2018 Bristol ..... G06F 1/163  
9,874,755 B2 \* 1/2018 Tempel ..... G02B 27/0176  
D809,517 S \* 2/2018 Sakata ..... D14/372  
D829,208 S \* 9/2018 Dallmeyer ..... D14/372  
D840,399 S \* 2/2019 Miller ..... D14/372

**1 Claim, 9 Drawing Sheets**

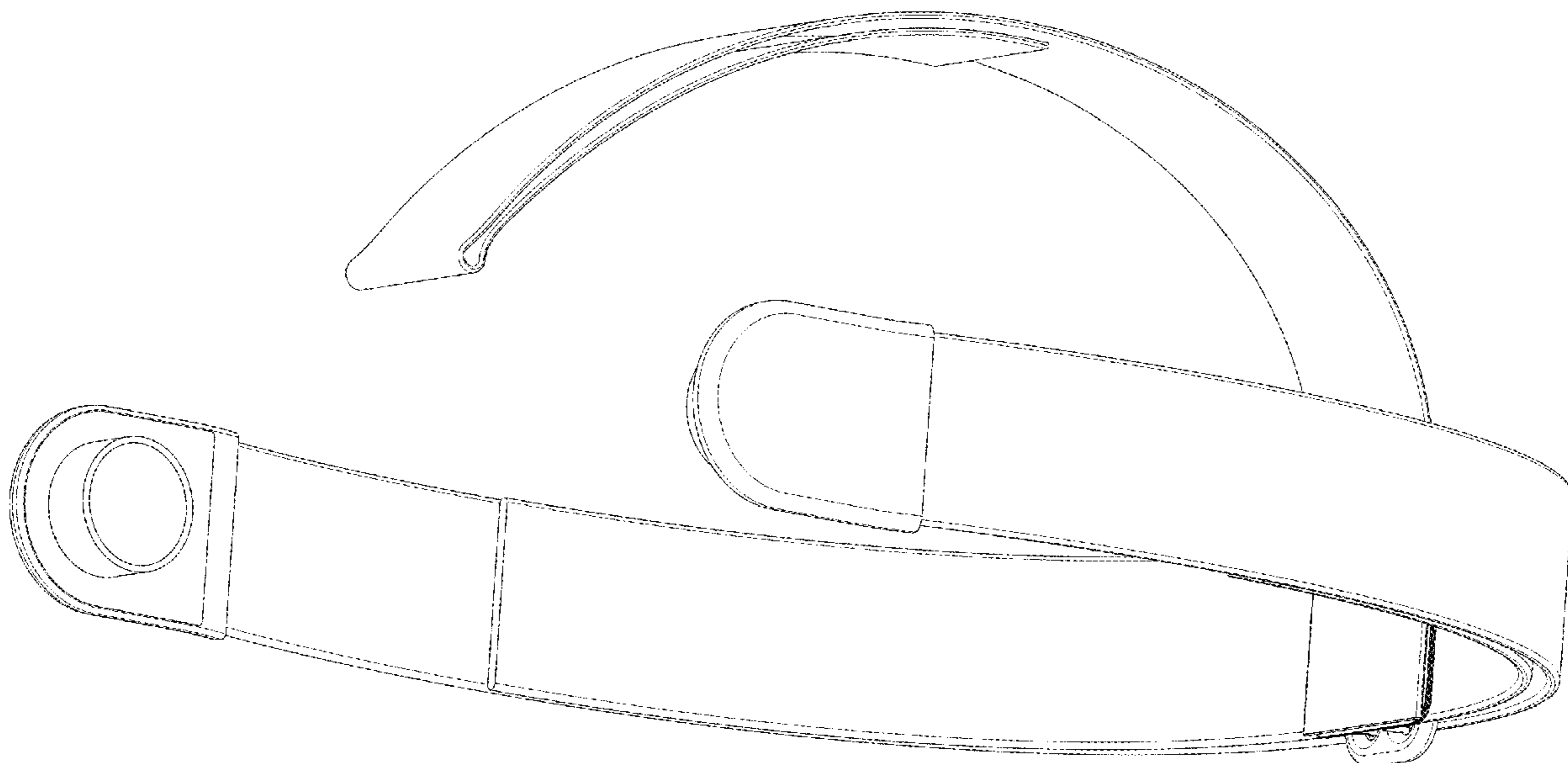

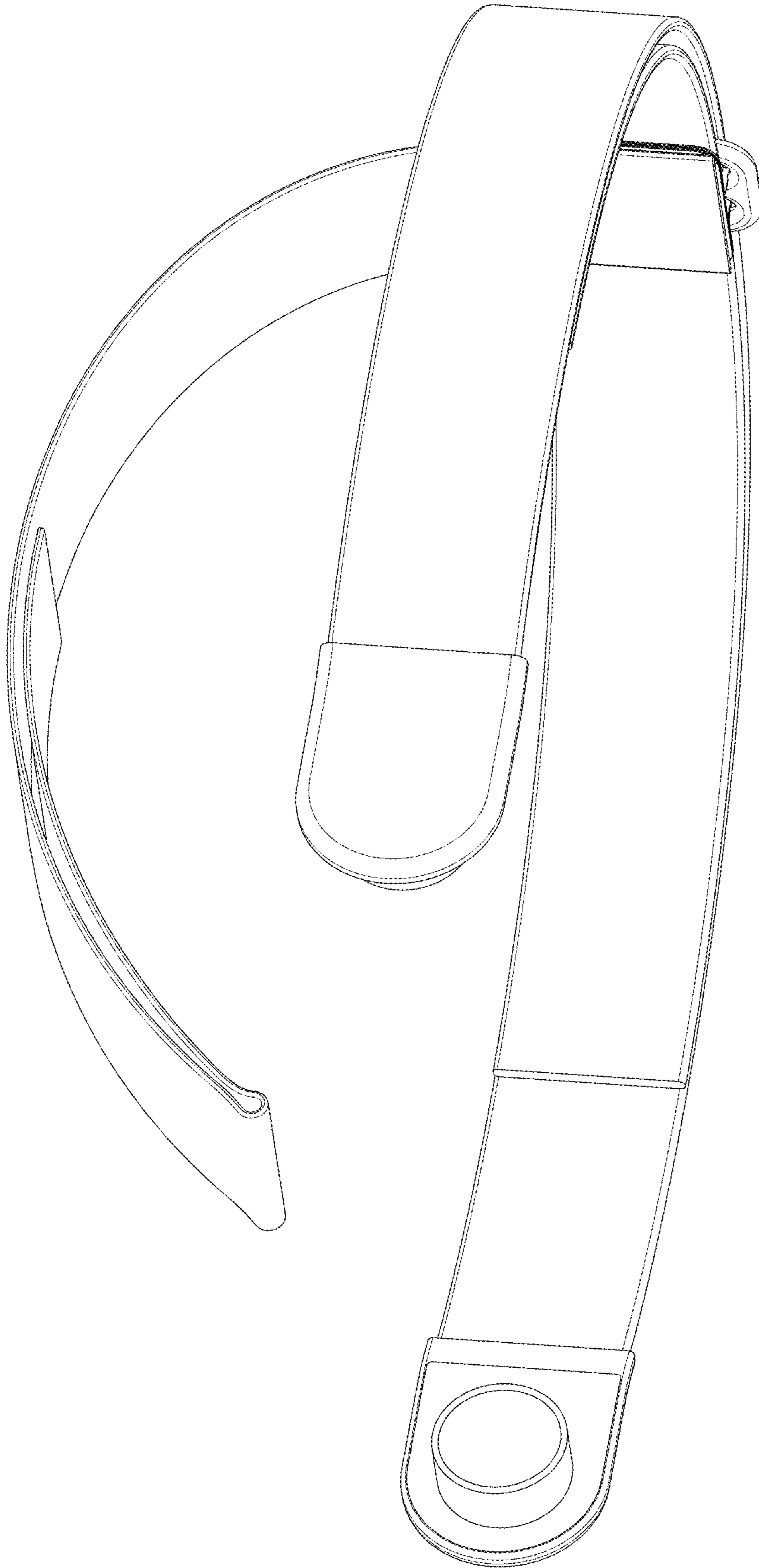

FIG. 1

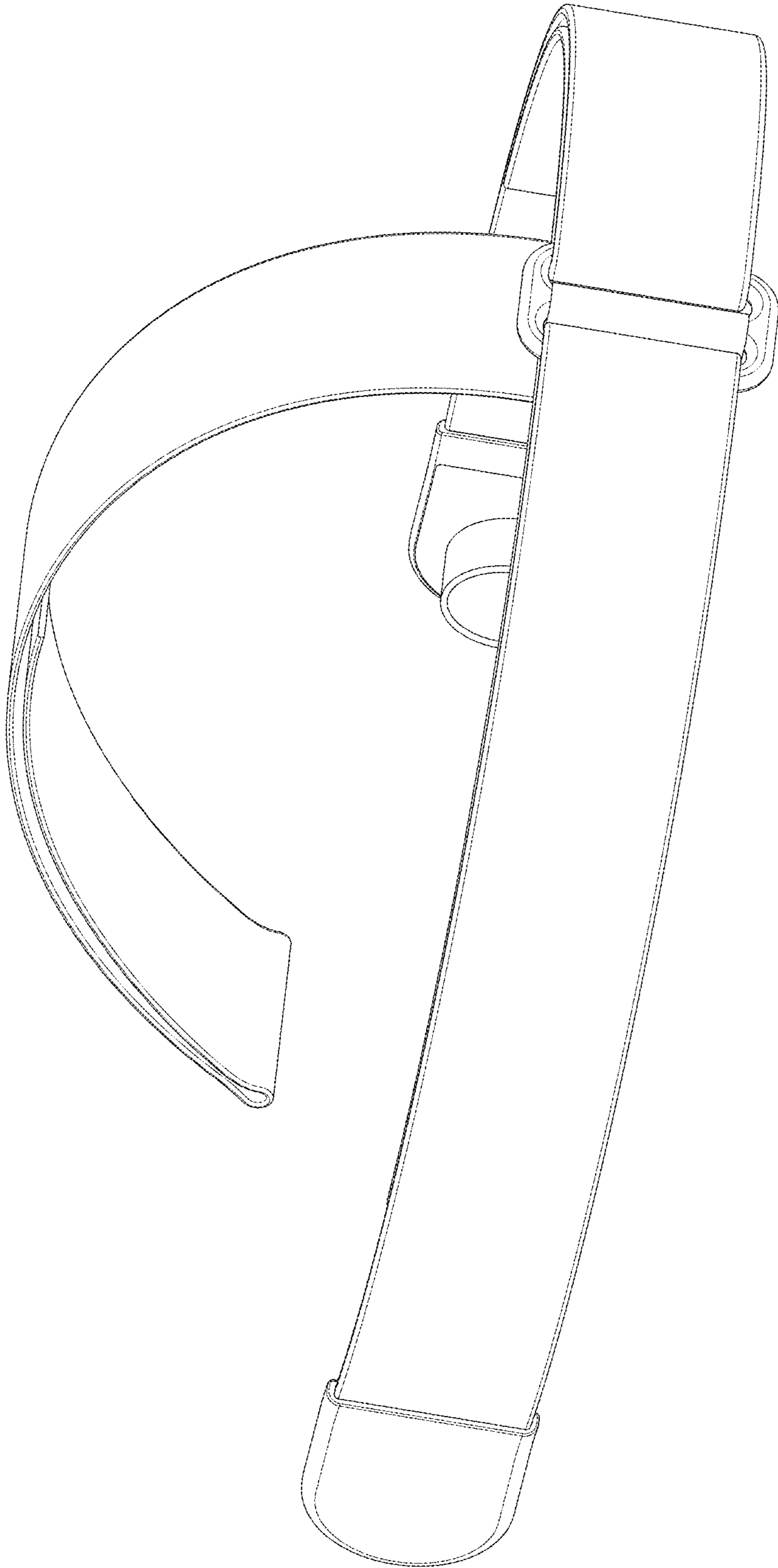

FIG. 2

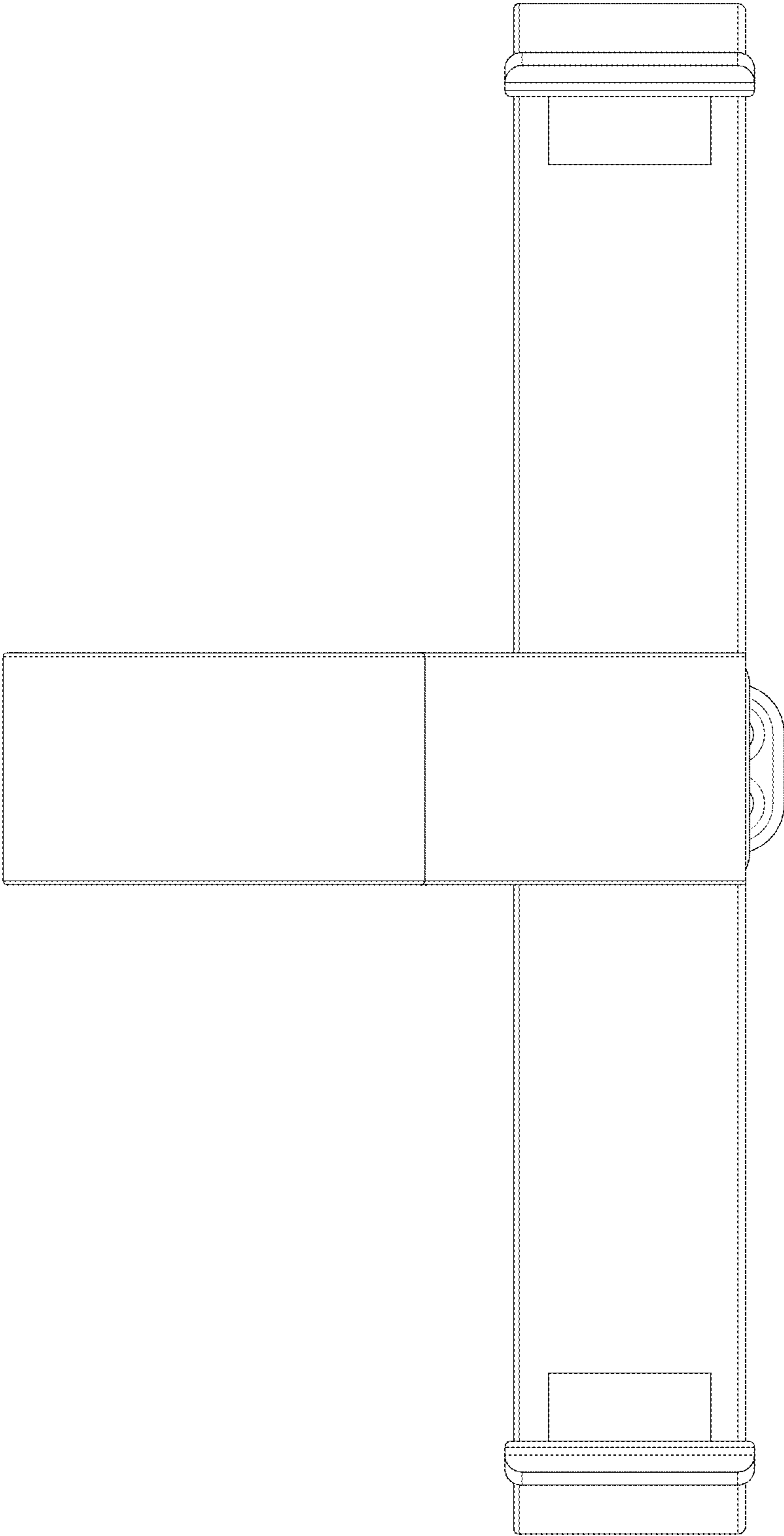

FIG. 3

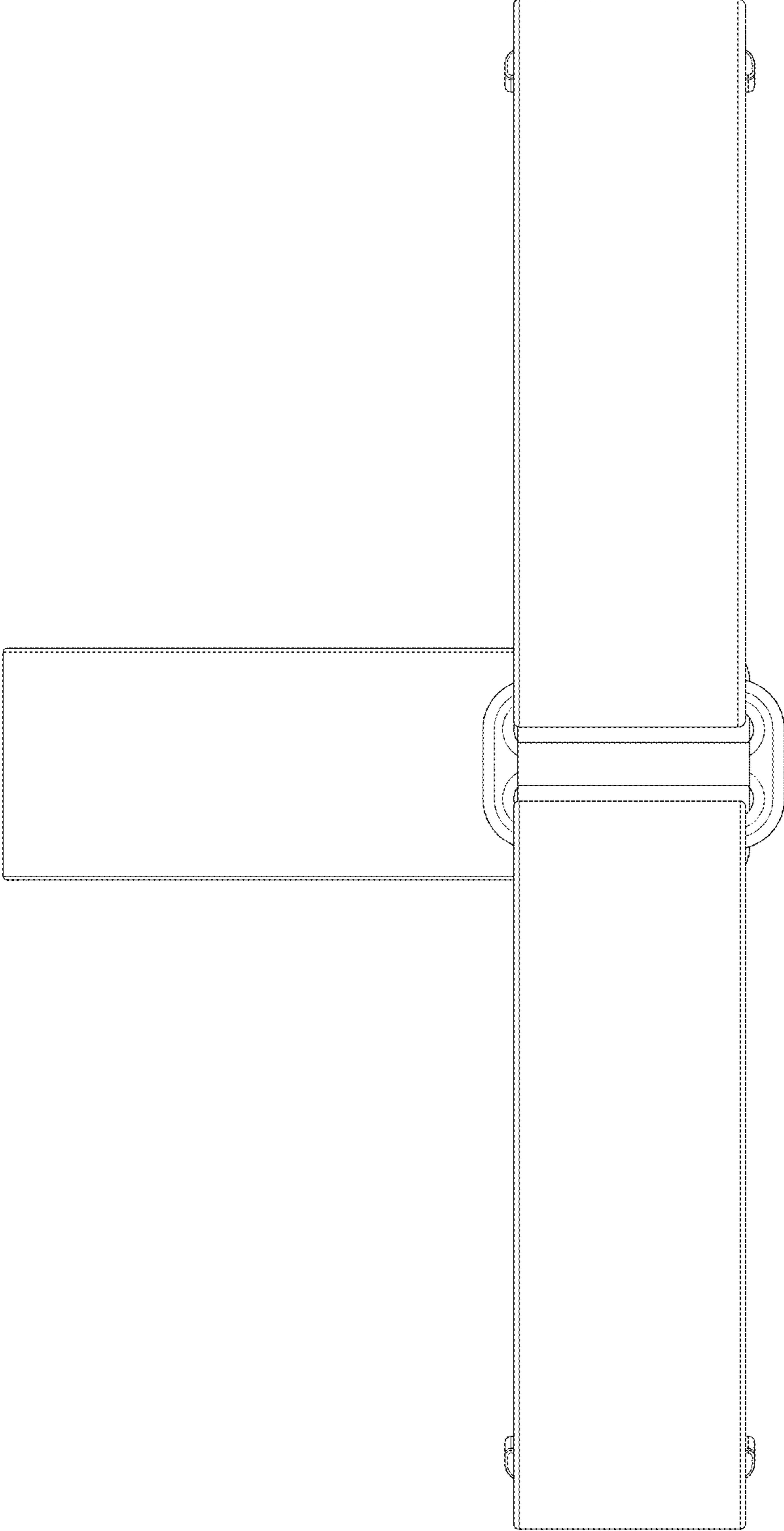

FIG. 4

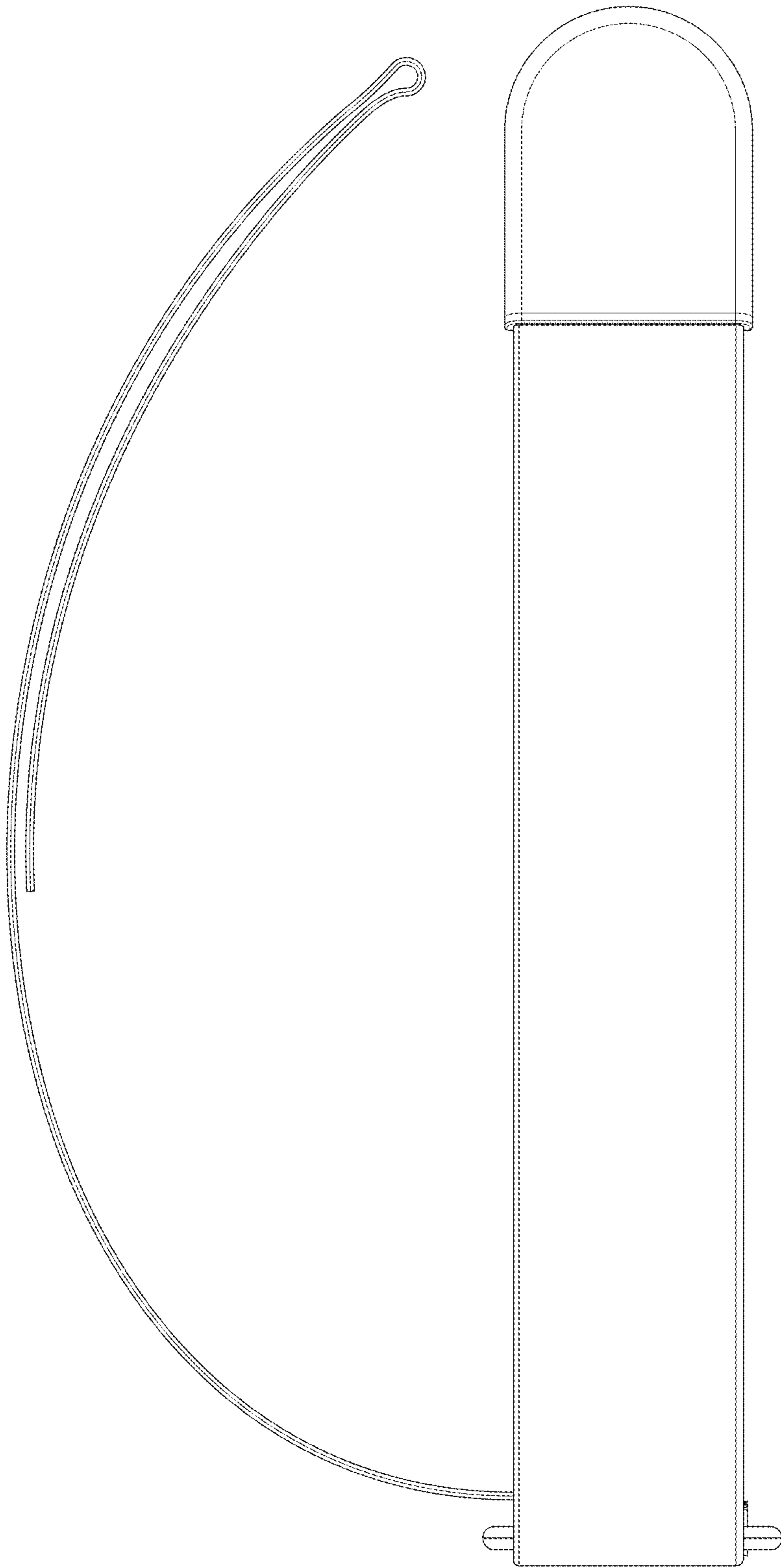

FIG. 5



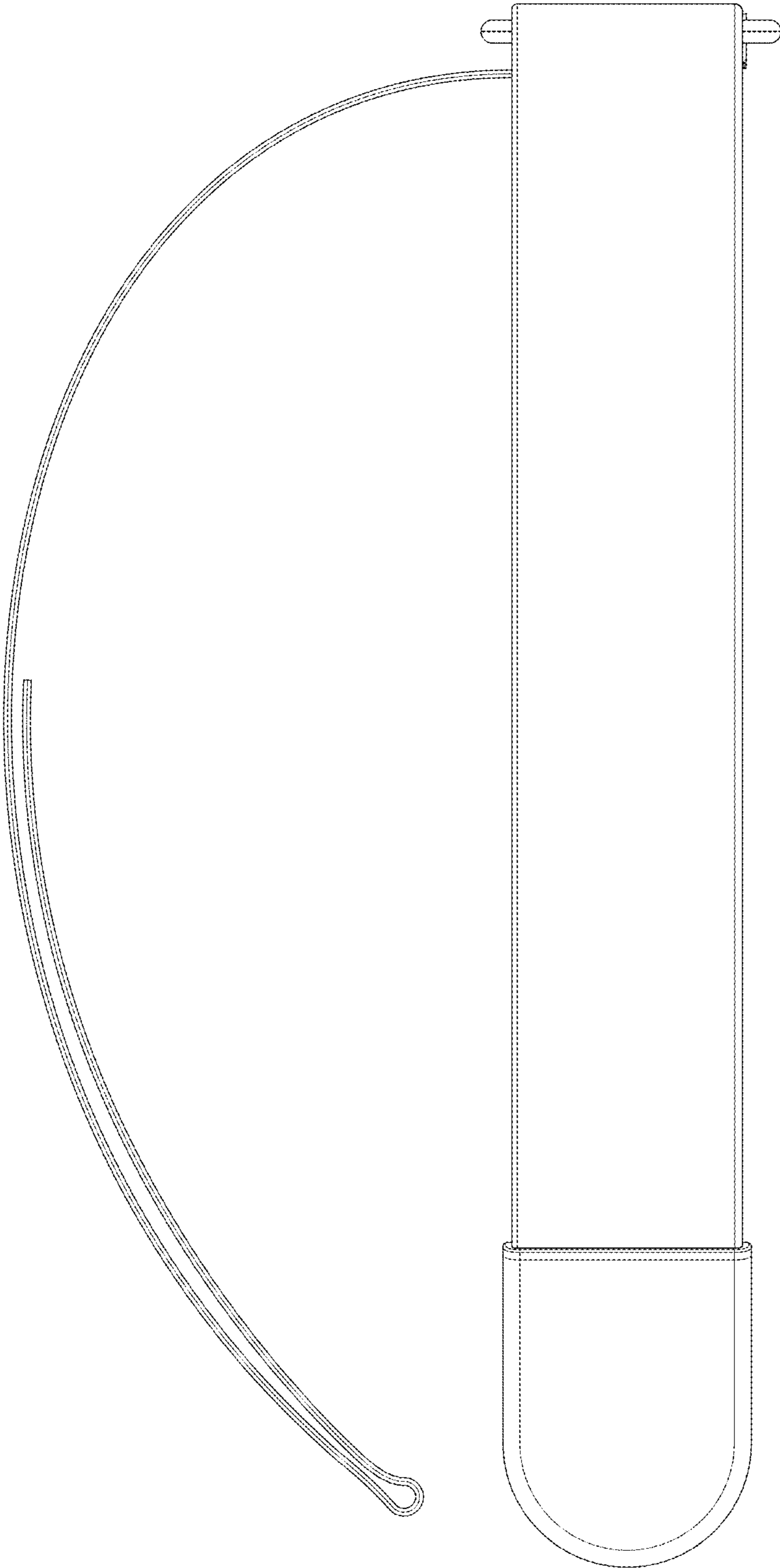

FIG. 6

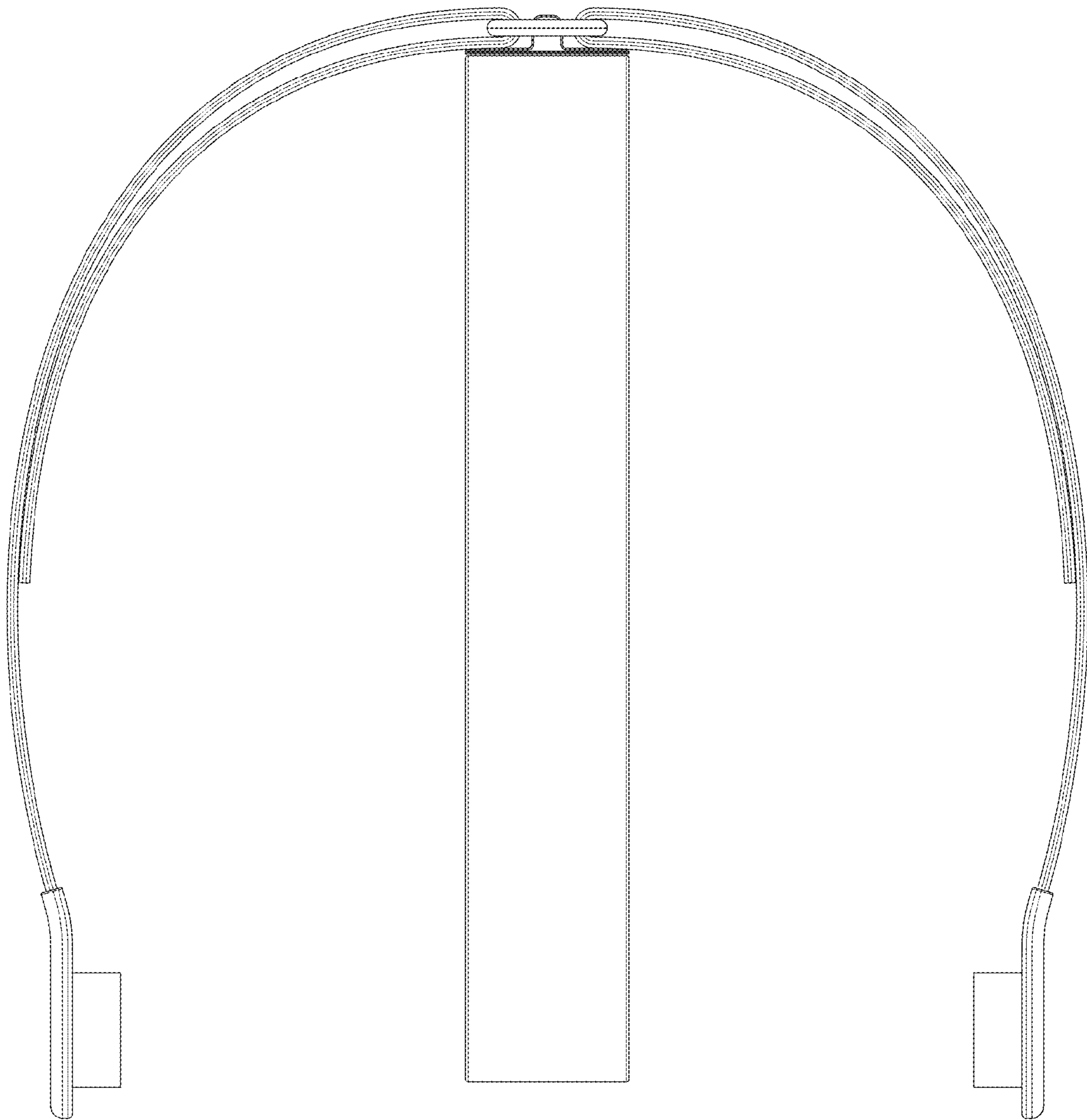

FIG. 7



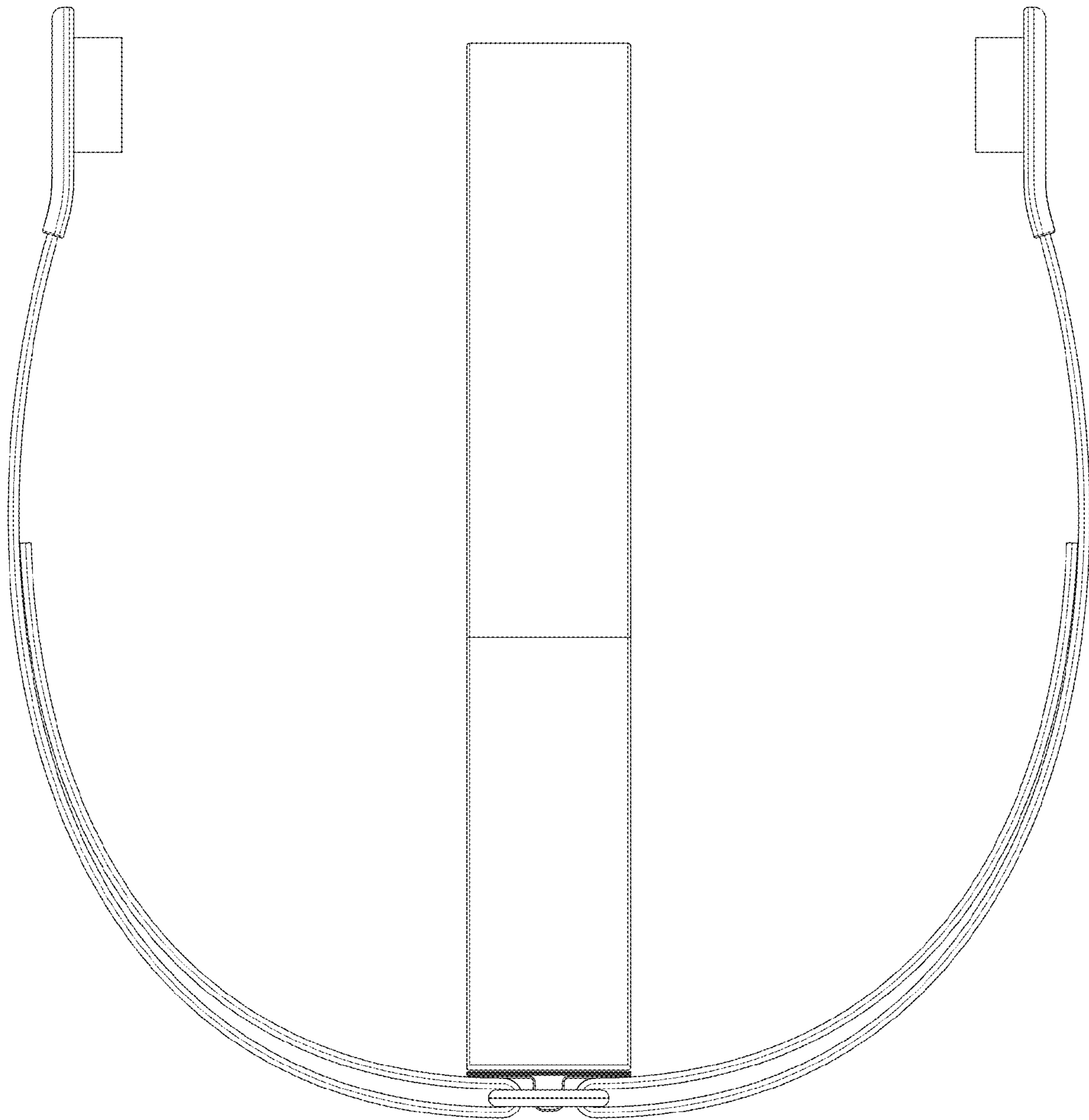

FIG. 8

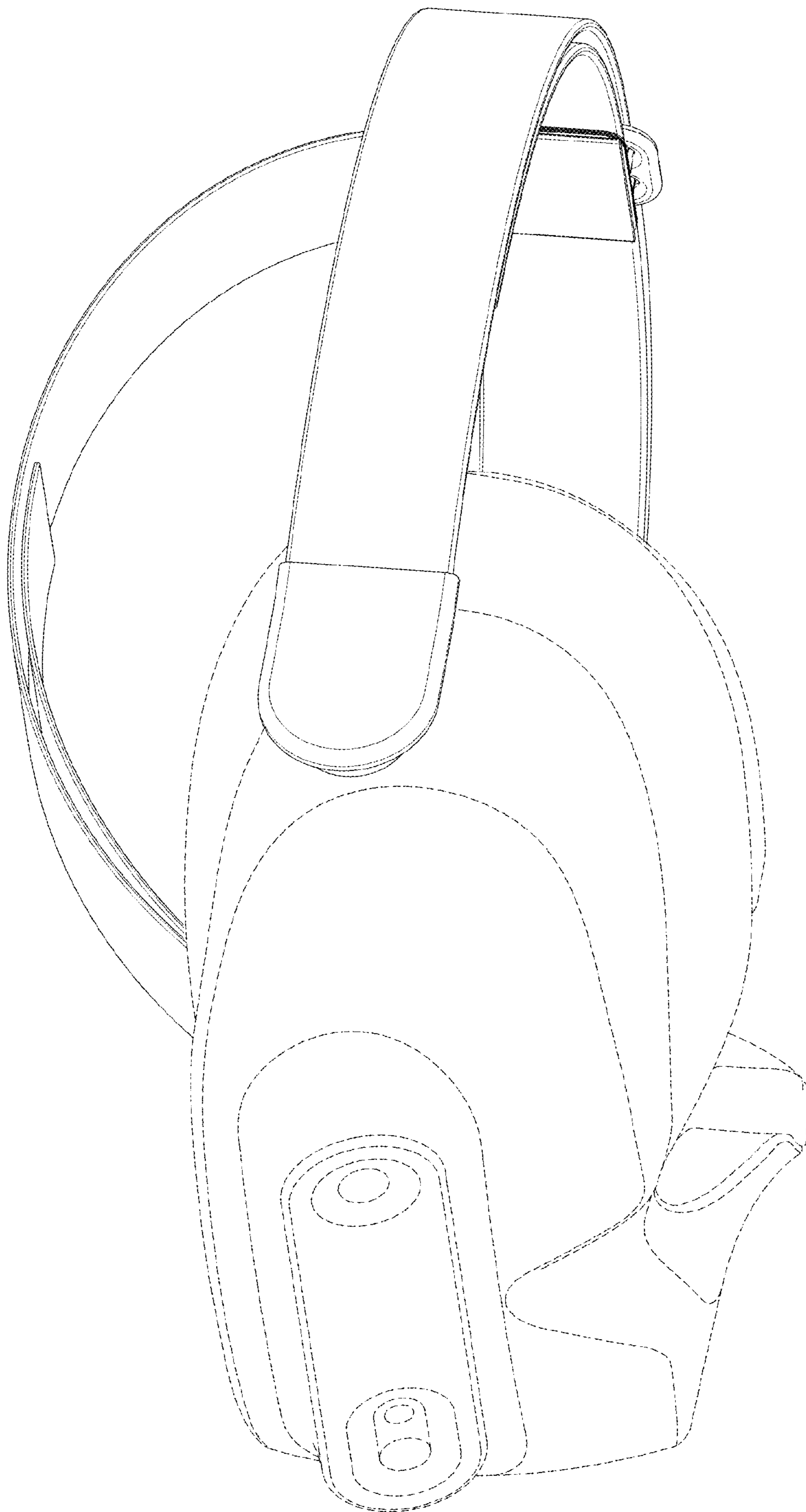

FIG. 9