



US00D889236S

(12) **United States Design Patent** (10) **Patent No.:** **US D889,236 S**
Karacostas et al. (45) **Date of Patent:** **** Jul. 7, 2020**

(54) **FOLDING KNIFE**

(74) *Attorney, Agent, or Firm* — Haynes & Boone, LLP

(71) Applicant: **NITE IZE, INC.**, Boulder, CO (US)

(57) **CLAIM**

(72) Inventors: **Dale Karacostas**, Boulder, CO (US);
Robin Liang, Guandong (CN)

The ornamental design for the folding knife, as shown and described.

(73) Assignee: **Nite Ize, Inc.**, Boulder, CO (US)

DESCRIPTION

(**) Term: **15 Years**

(21) Appl. No.: **29/650,683**

(22) Filed: **Jun. 8, 2018**

(51) **LOC (12) Cl.** **08-03**

(52) **U.S. Cl.**
USPC **D8/99**

(58) **Field of Classification Search**
USPC D8/14, 17, 98, 99, 100, 105; D22/118
CPC B26B 1/00; B26B 1/02; B26B 1/04; B26B
5/00; B26B 5/006; B26B 1/10; B26B
1/046

See application file for complete search history.

(56) **References Cited**

U.S. PATENT DOCUMENTS

D306,687 S *	3/1990	Inman	D8/105
D310,014 S *	8/1990	Inman	D8/99
D367,599 S *	3/1996	Sakai	D8/99
D373,296 S *	9/1996	Thompson	D8/99
D409,471 S *	5/1999	Thompson	D8/99
6,276,063 B1 *	8/2001	Chen	B26B 1/046 30/155
D461,387 S	8/2002	Glesser		
D479,114 S *	9/2003	Onion	D8/99
D553,469 S *	10/2007	Onion	D8/99
D632,755 S *	2/2011	Weiguo	D22/118
D633,772 S *	3/2011	Behler	D8/99
D754,515 S *	4/2016	Harsey	D8/99

(Continued)

Primary Examiner — Philip S Hyder

FIG. 1 shows a front perspective view of a folding knife in the open position;
 FIG. 2 shows a front perspective view of the folding knife in the closed position;
 FIG. 3 shows a rear perspective view of the folding knife in the open position of FIG. 1;
 FIG. 4 shows a rear perspective view of the folding knife in the closed position of FIG. 2;
 FIG. 5 shows a front elevation view of the folding knife in the open position of FIG. 1;
 FIG. 6 shows a front elevation view of the folding knife in the closed position of FIG. 2;
 FIG. 7 shows a rear elevation view of the folding knife in the open position of FIG. 1;
 FIG. 8 shows a rear elevation view of the folding knife in the closed position of FIG. 2;
 FIG. 9 shows a top plan view of the folding knife in the open position of FIG. 1;
 FIG. 10 shows a top plan view of the folding knife in the closed position of FIG. 2;
 FIG. 11 shows a bottom plan view of the folding knife in the open position of FIG. 1;
 FIG. 12 shows a bottom plan view of the folding knife in the closed position of FIG. 1;
 FIG. 13 shows a right side elevation view of the folding knife in the open position of FIG. 1;
 FIG. 14 shows a left side elevation view of the folding knife in the open position of FIG. 1;
 FIG. 15 shows a left side elevation view of the folding knife in the closed position of FIG. 2; and,
 FIG. 16 shows a right side elevation view of the folding knife in the closed position of FIG. 2.

1 Claim, 6 Drawing Sheets

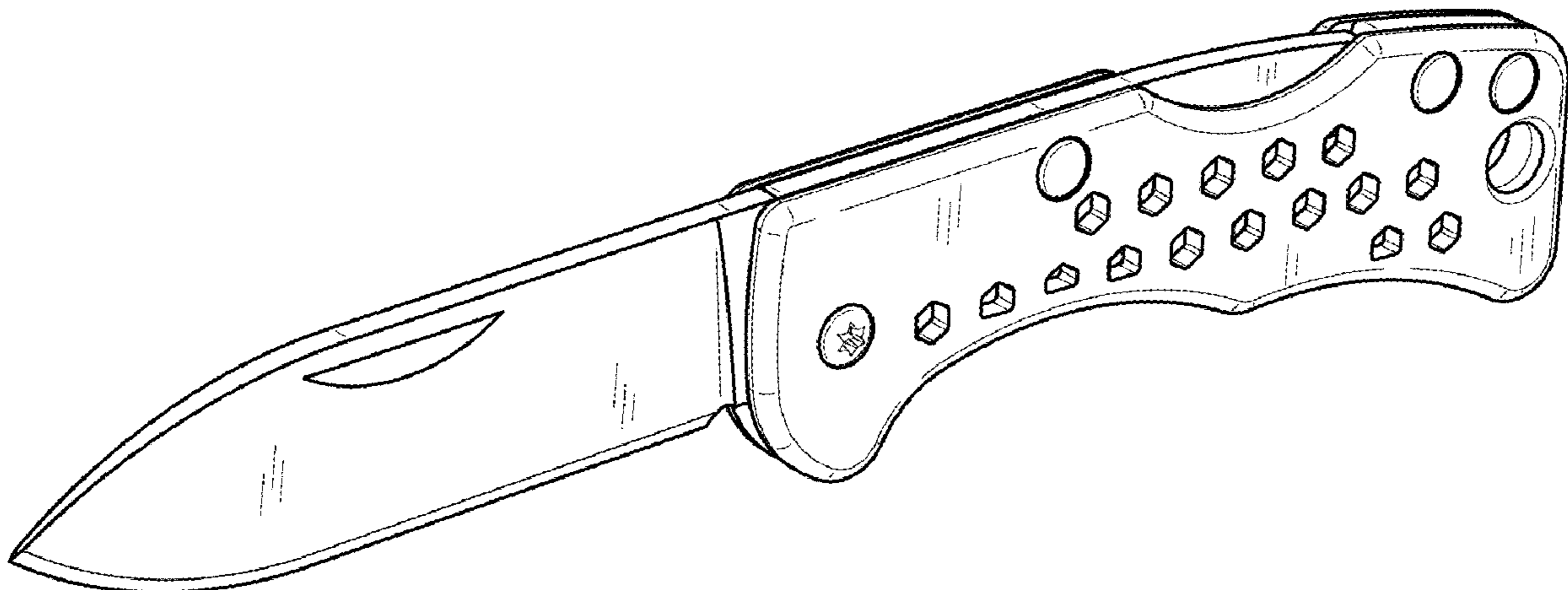

(56)

References Cited

U.S. PATENT DOCUMENTS

D768,457 S * 10/2016 Yuhuan D8/99
D769,694 S * 10/2016 Mingyi D8/99

* cited by examiner

FIG. 1

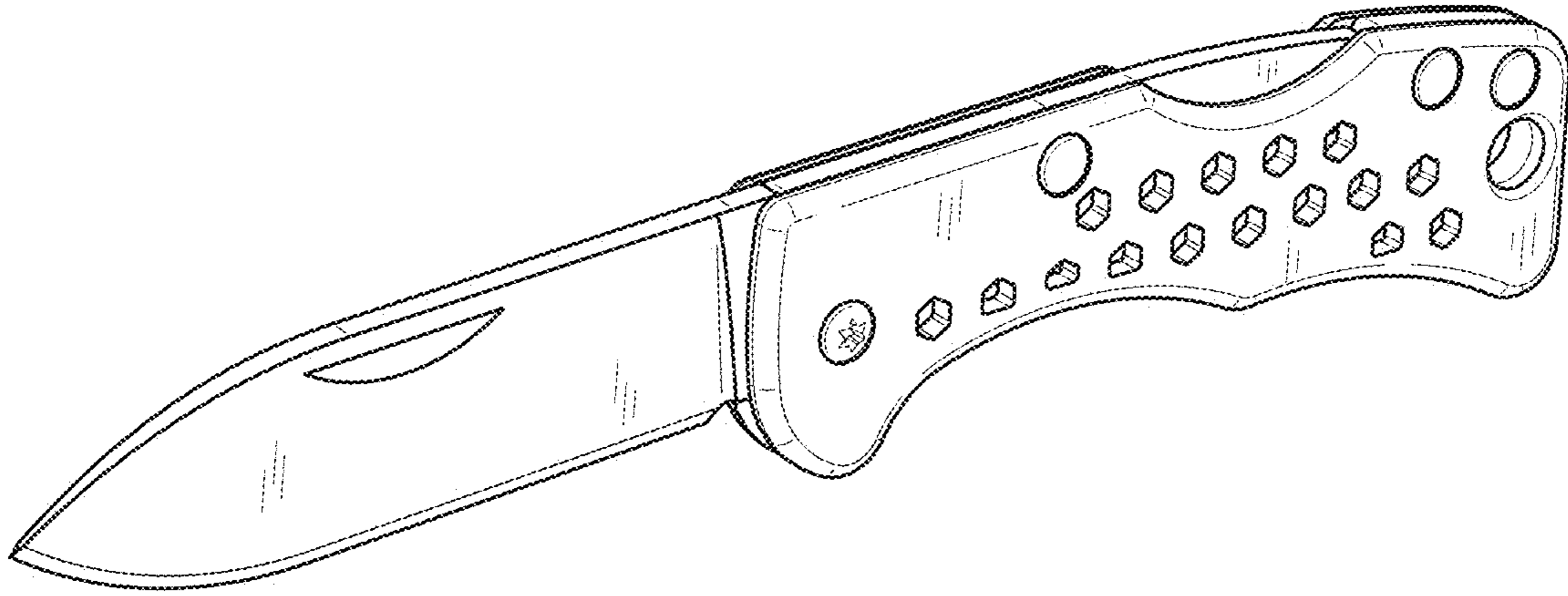

FIG. 2

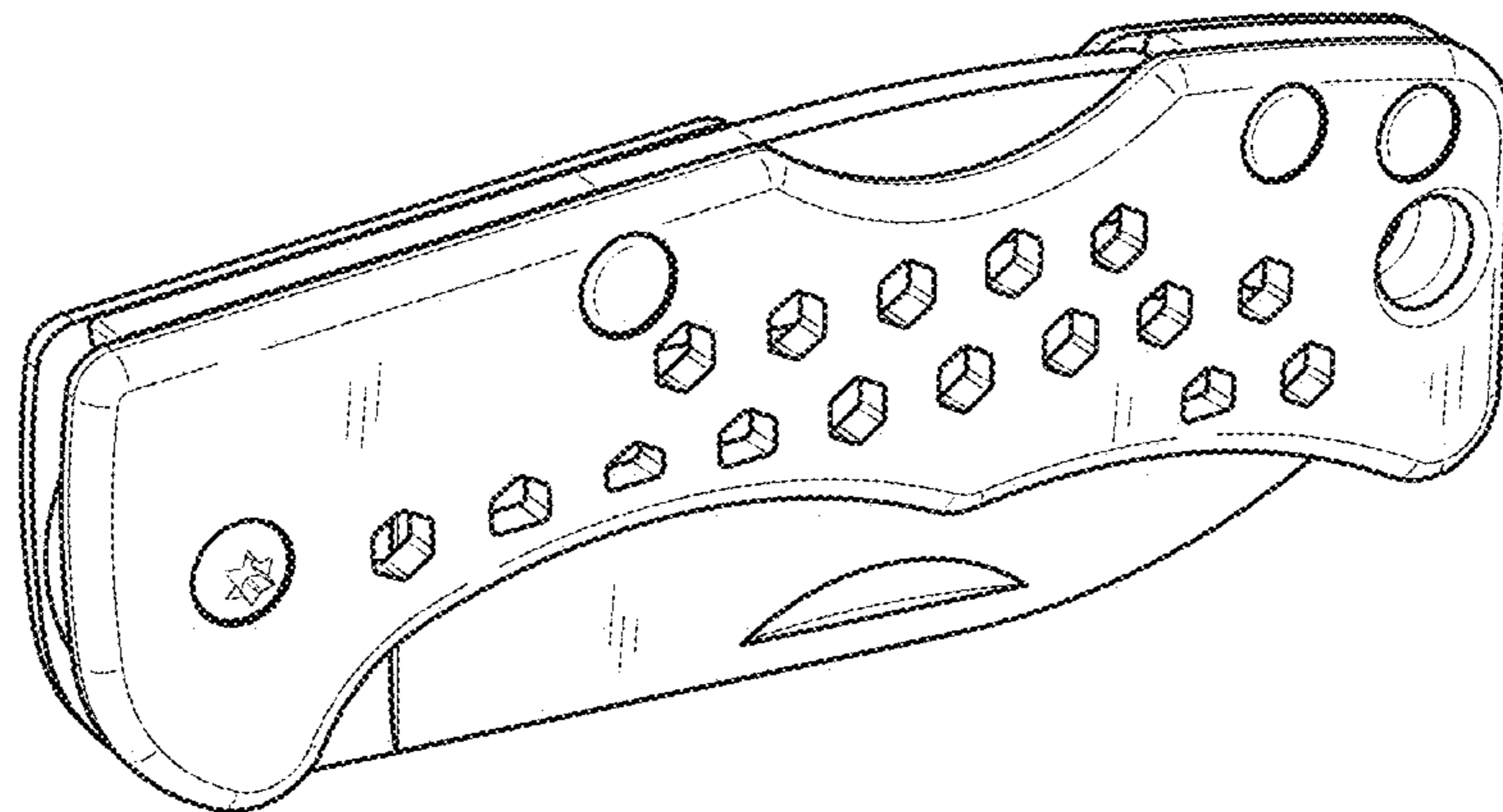

FIG. 3

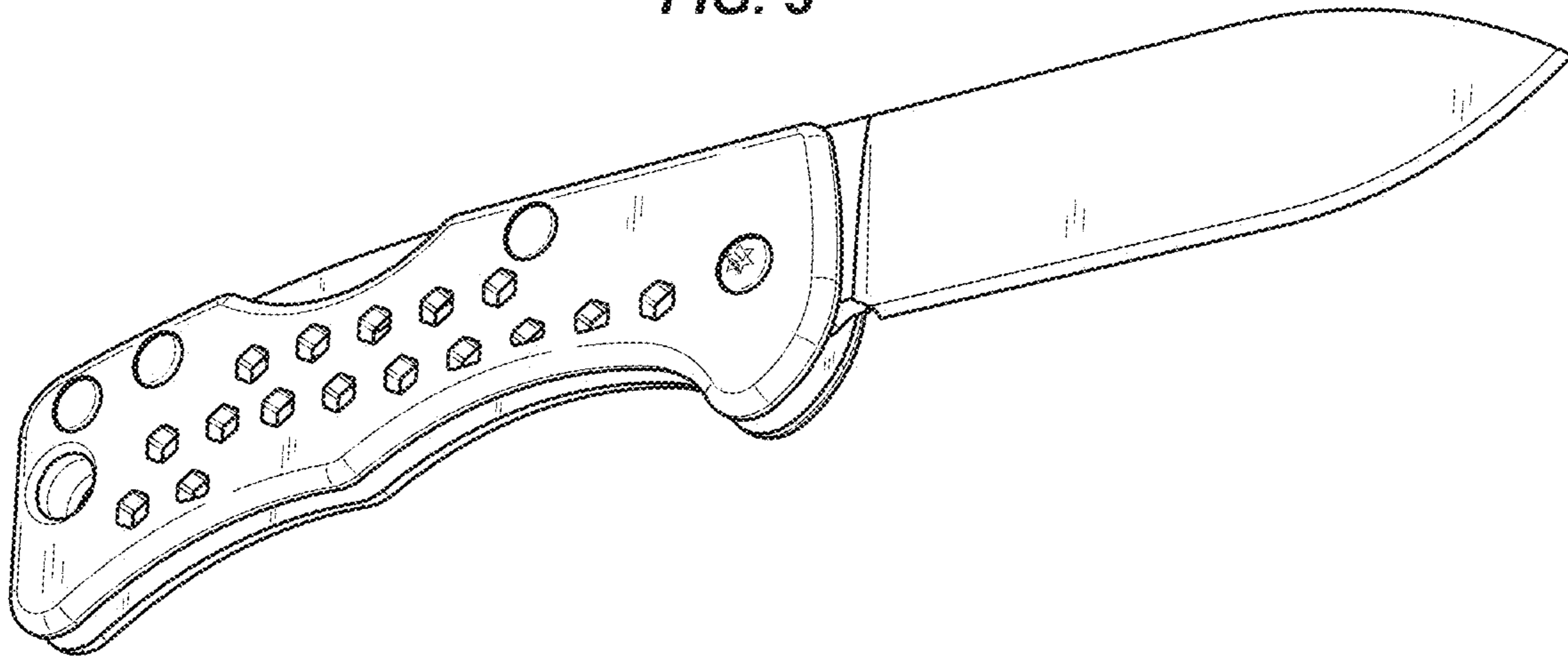

FIG. 4

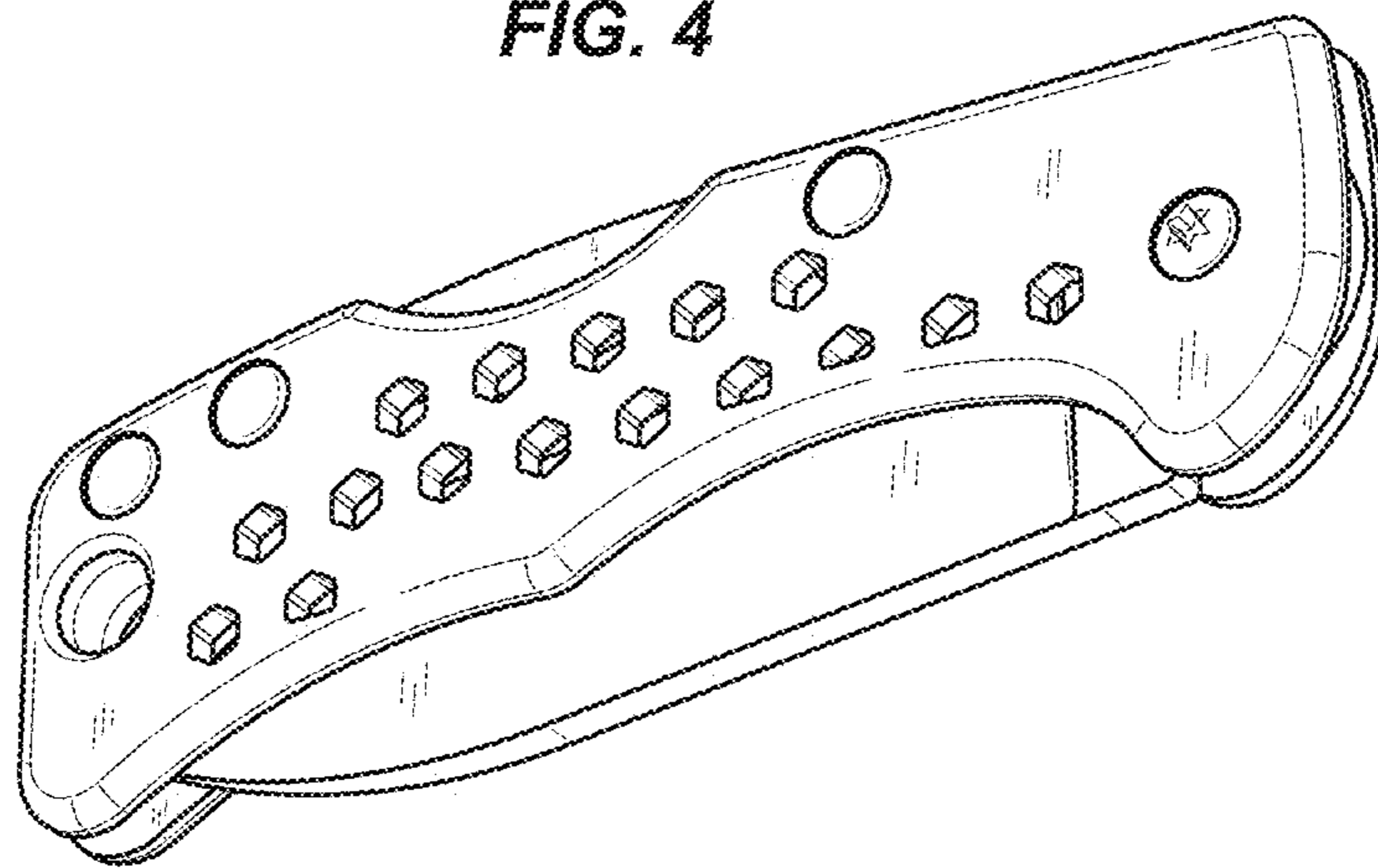

FIG. 5

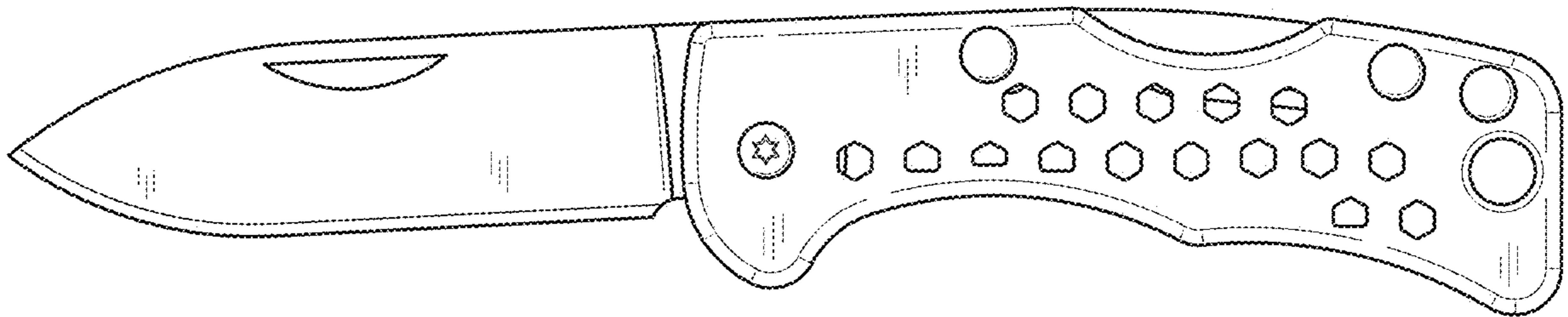

FIG. 6

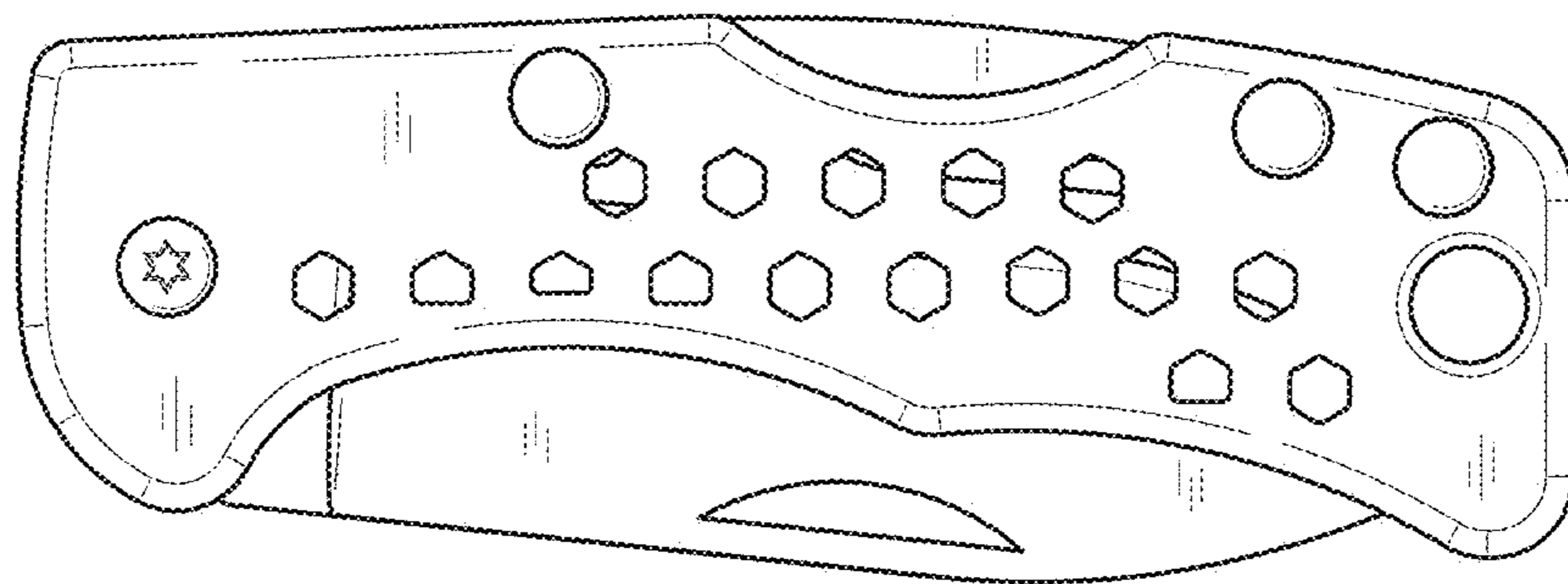

FIG. 7

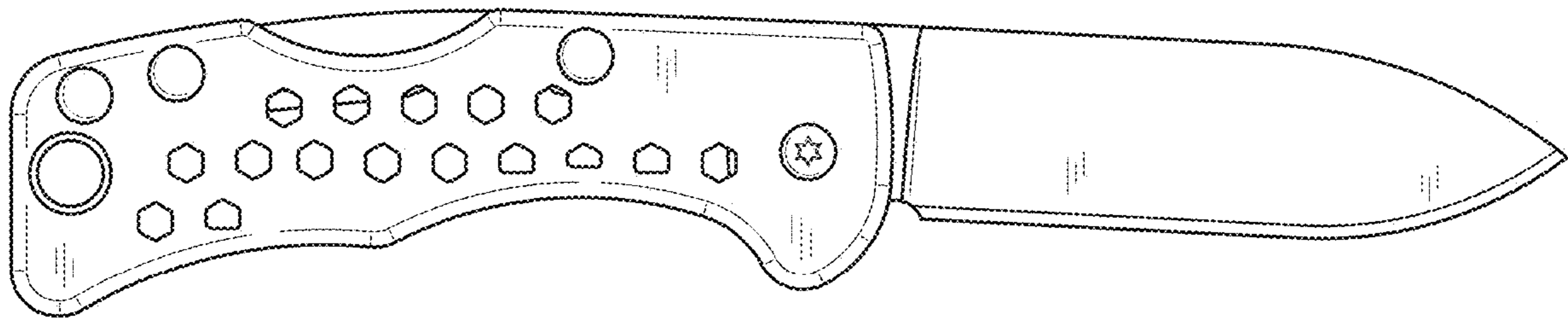

FIG. 8

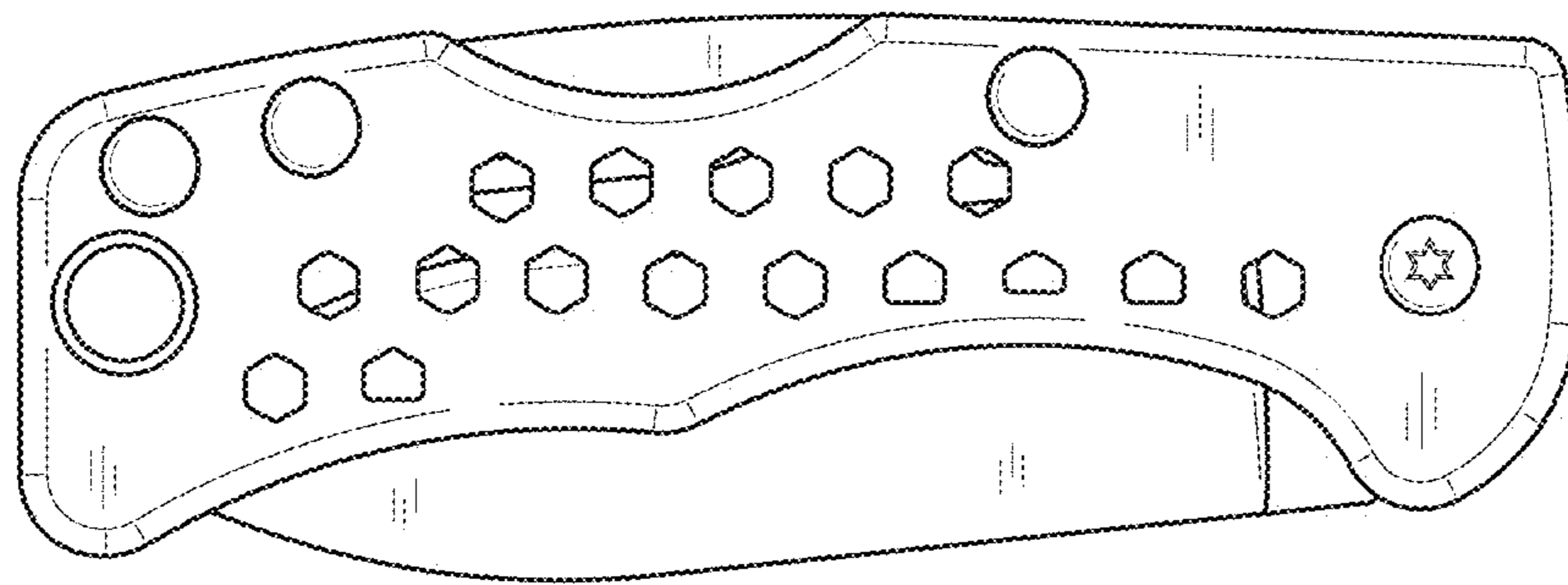

FIG. 9

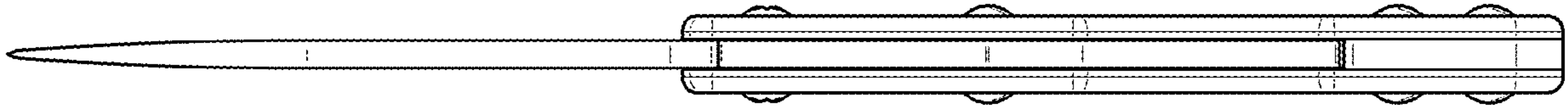

FIG. 10

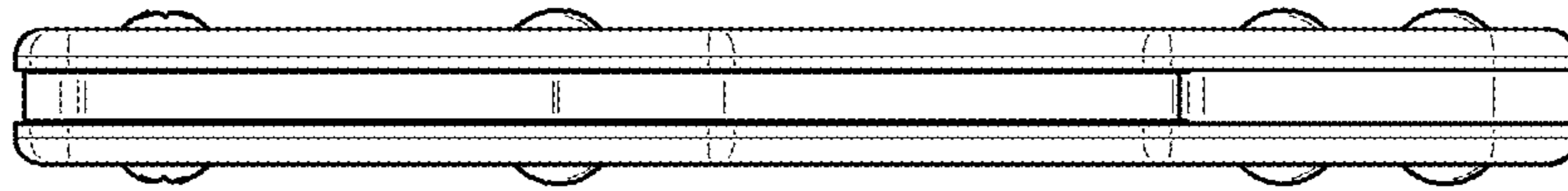

FIG. 11

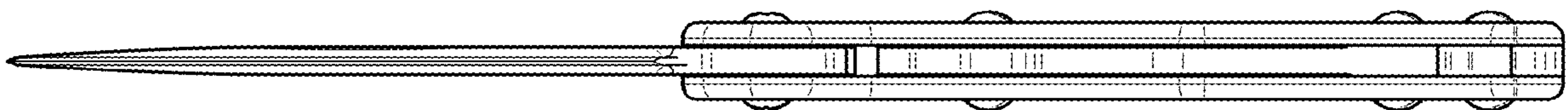

FIG. 12

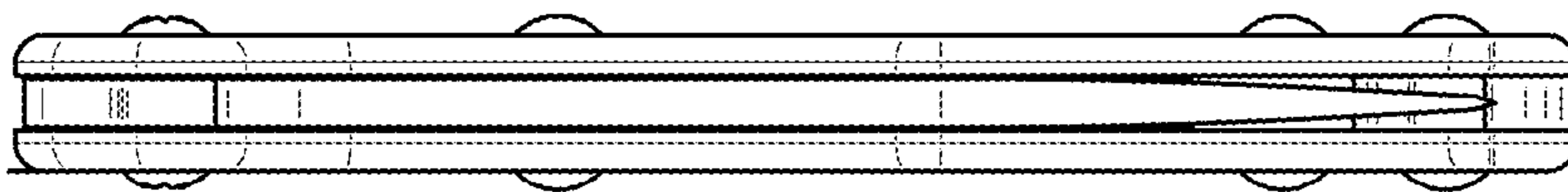

FIG. 13

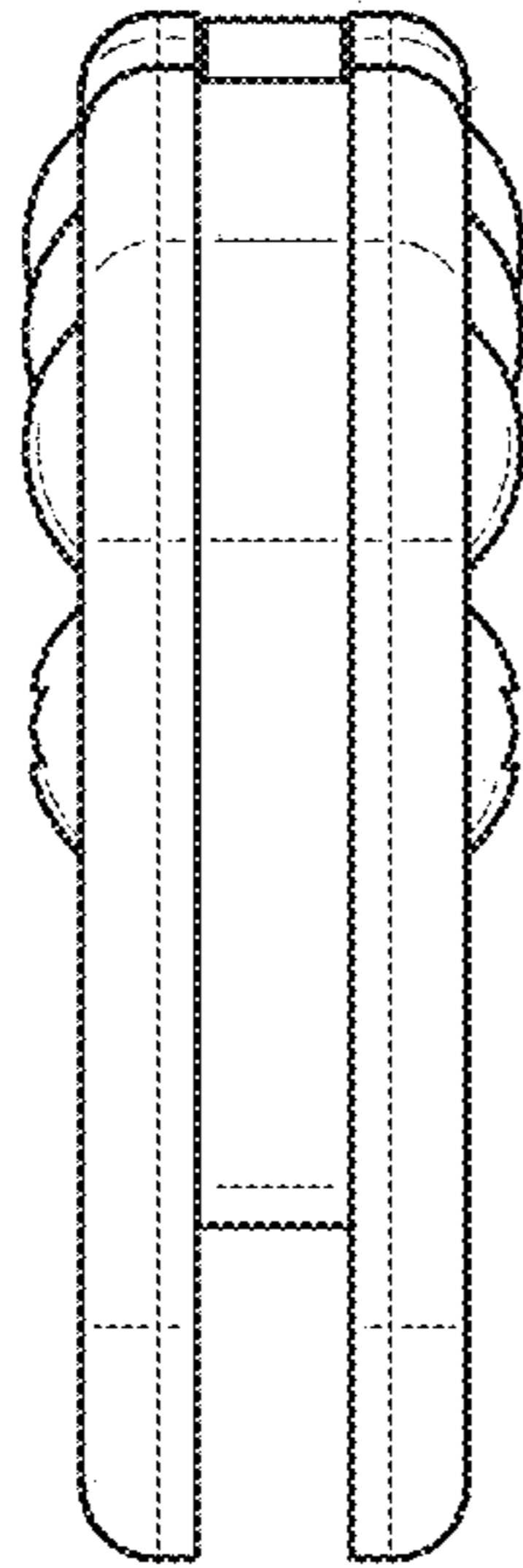

FIG. 14

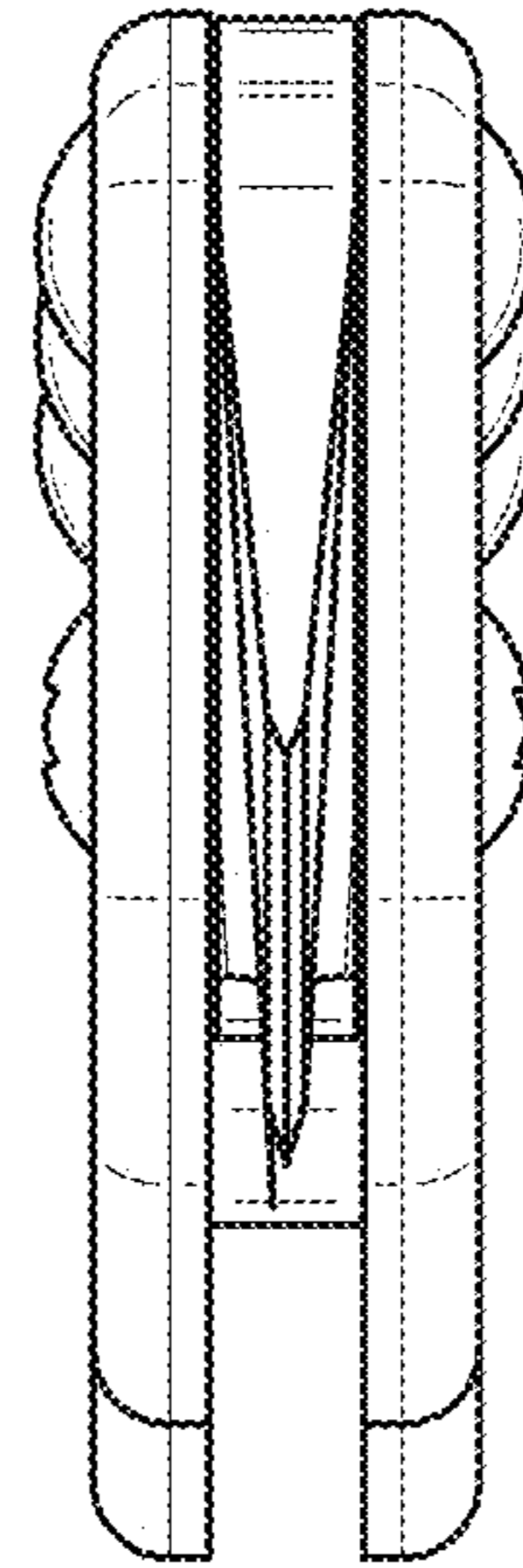

FIG. 15

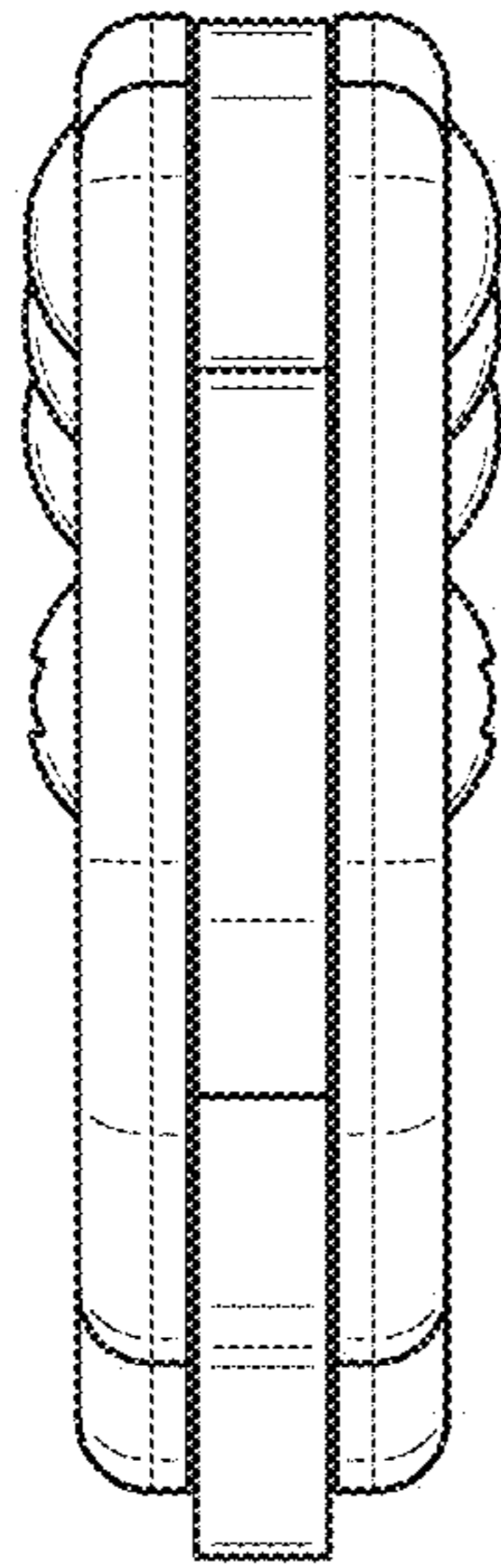

FIG. 16

