



US00D889145S

(12) **United States Design Patent**
Valene

(10) **Patent No.:** **US D889,145 S**

(45) **Date of Patent:** **** Jul. 7, 2020**

(54) **COLLAPSIBLE ENTERTAINMENT ROCKER**

(75) Inventor: **Murray S. Valene**, New Orleans, LA (US)

(73) Assignee: **Ace Bayou Corporation**, New Orleans, LA (US)

(*) Notice: This patent is subject to a terminal disclaimer.

(**) Term: **14 Years**

(21) Appl. No.: **29/225,747**

(22) Filed: **Mar. 18, 2005**

(51) **LOC (12) Cl.** **06-01**

(52) **U.S. Cl.**
USPC **D6/348; D6/368**

(58) **Field of Classification Search**
USPC D6/334–336, 344, 348, 360, 361, 369, D6/370, 371–373, 374, 375, 500–502, D6/716, 716.1, 716.2, 716.3, 716.4, 365, D6/368; 472/114; 297/258.1, 270.3, 297/270.5, 271.5, 271.6; D21/412, 688; D12/412, 688
CPC A47C 3/02; A47C 3/027; A47C 3/029; A47C 3/16; A47C 7/24
See application file for complete search history.

(56) **References Cited**

U.S. PATENT DOCUMENTS

2,482,306	A *	9/1949	Waldheim	297/270.3
D163,297	S *	5/1951	Laskowitz	D6/361
3,227,445	A *	1/1966	Jensen	472/114
D209,446	S *	12/1967	Delieuvin	D6/361
D214,835	S *	8/1969	Lockwood	D6/348
D245,132	S *	7/1977	Gale, Jr.	D6/348
4,109,960	A *	8/1978	Stinchfield	297/271.5
D286,802	S *	11/1986	Ahlberg	D21/688
4,902,003	A *	2/1990	Buoni	482/140

D326,958	S *	6/1992	Royle et al.	D6/348
D360,665	S *	7/1995	Hatfield	D21/688
D374,695	S *	10/1996	Hatfield	D21/412
D375,415	S *	11/1996	Cutten	D6/361
D376,628	S *	12/1996	Hatfield	D21/688
D422,800	S *	4/2000	Lau	D6/348
D577,212	S *	9/2008	Lee	D6/348
D801,711	S *	11/2017	Mao	D6/348

(Continued)

Primary Examiner — Mimoso De

(74) *Attorney, Agent, or Firm* — Moss & Barnett; Michael A. Bondi

(57) **CLAIM**

The ornamental design for a collapsible entertainment rocker, as shown.

DESCRIPTION

FIG. 1 is a bottom view, collapsible mode, of a collapsible entertainment rocker showing my new design in a closed up mode;
FIG. 2 is a back view, collapsible mode, thereof of FIG. 1;
FIG. 3 is a left side view, collapsible mode, thereof of FIG. 1;
FIG. 4 is a front view, collapsible mode, thereof of FIG. 1;
FIG. 5 is a right side view, collapsible mode, thereof of FIG. 1;
FIG. 6 is a top view, collapsible mode, thereof of FIG. 1;
FIG. 7 is a front view, unfolded mode thereof of the collapsible entertainment rocker in an unfolded mode;
FIG. 8 is an isometric view thereof;
FIG. 9 is a left side view thereof;
FIG. 10 is a back side view thereof;
FIG. 11 is a right side view thereof;
FIG. 12 is a closeup view of closed hinge flap thereof; and, FIG. 13 is a front view thereof.
The dashed lines shown in the drawing are understood to represent stitching.

1 Claim, 13 Drawing Sheets

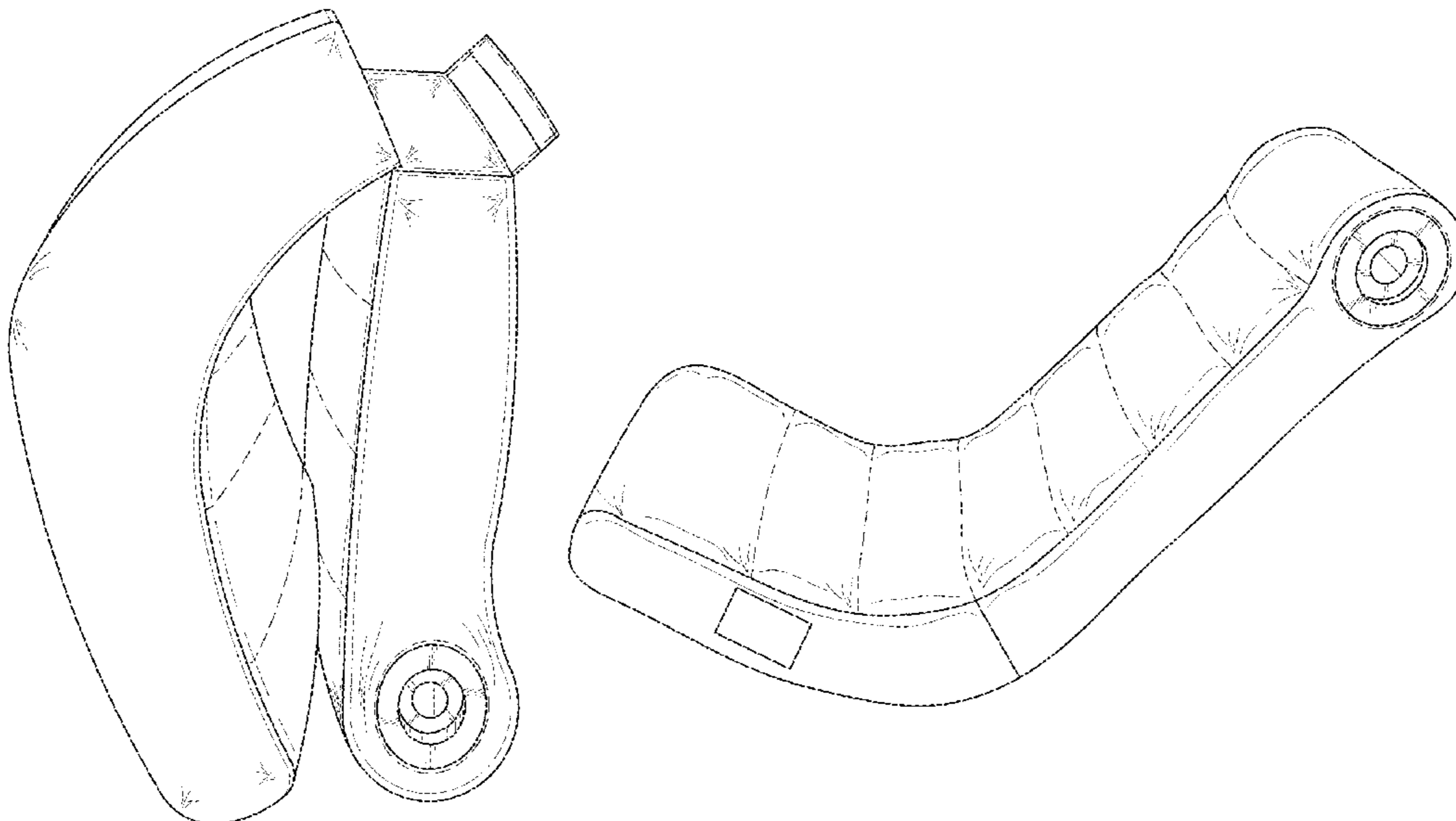

(56)

References Cited

U.S. PATENT DOCUMENTS

D807,068 S * 1/2018 Mao D6/348
D812,923 S * 3/2018 Mao D6/365

* cited by examiner

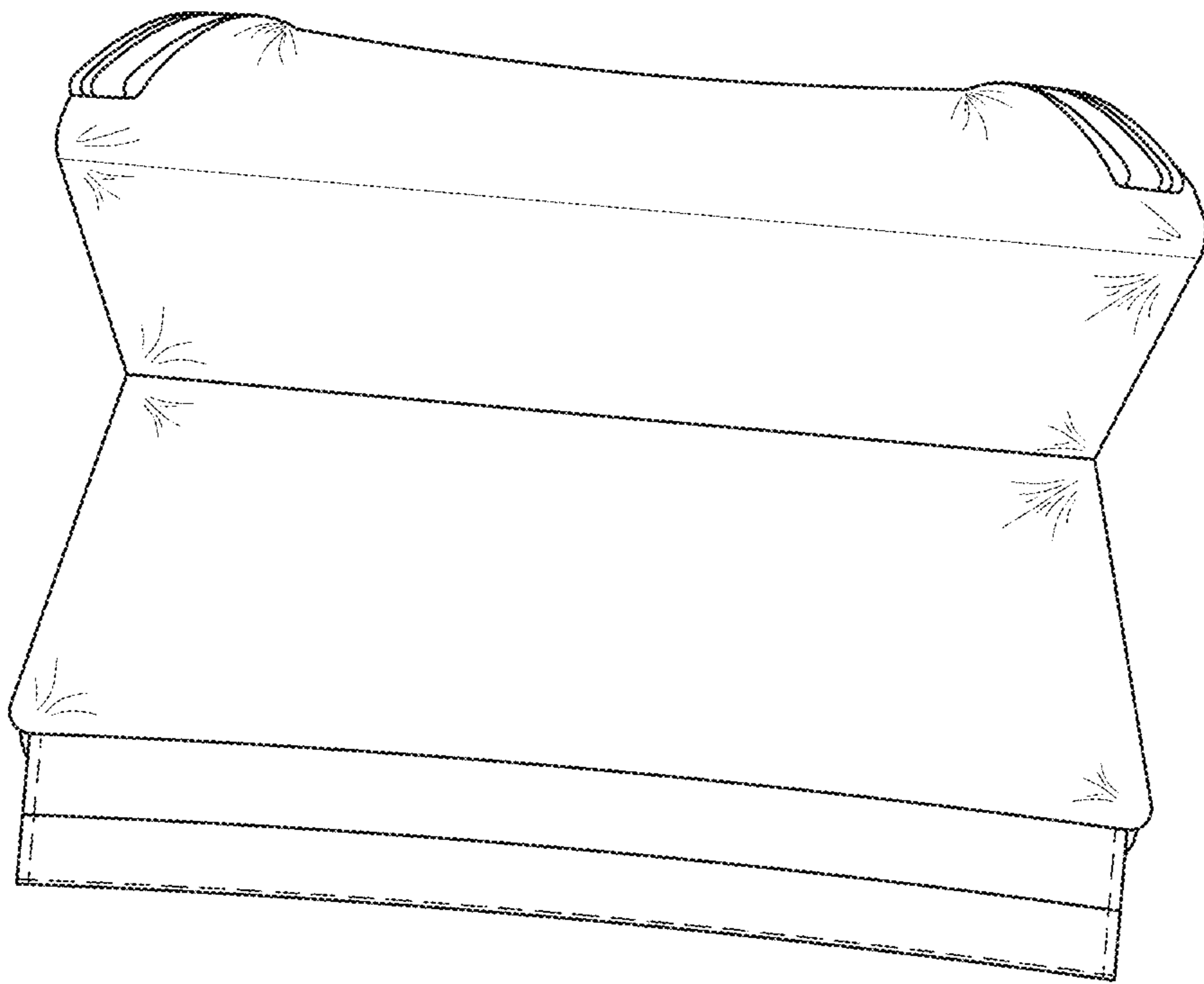

FIG. 1

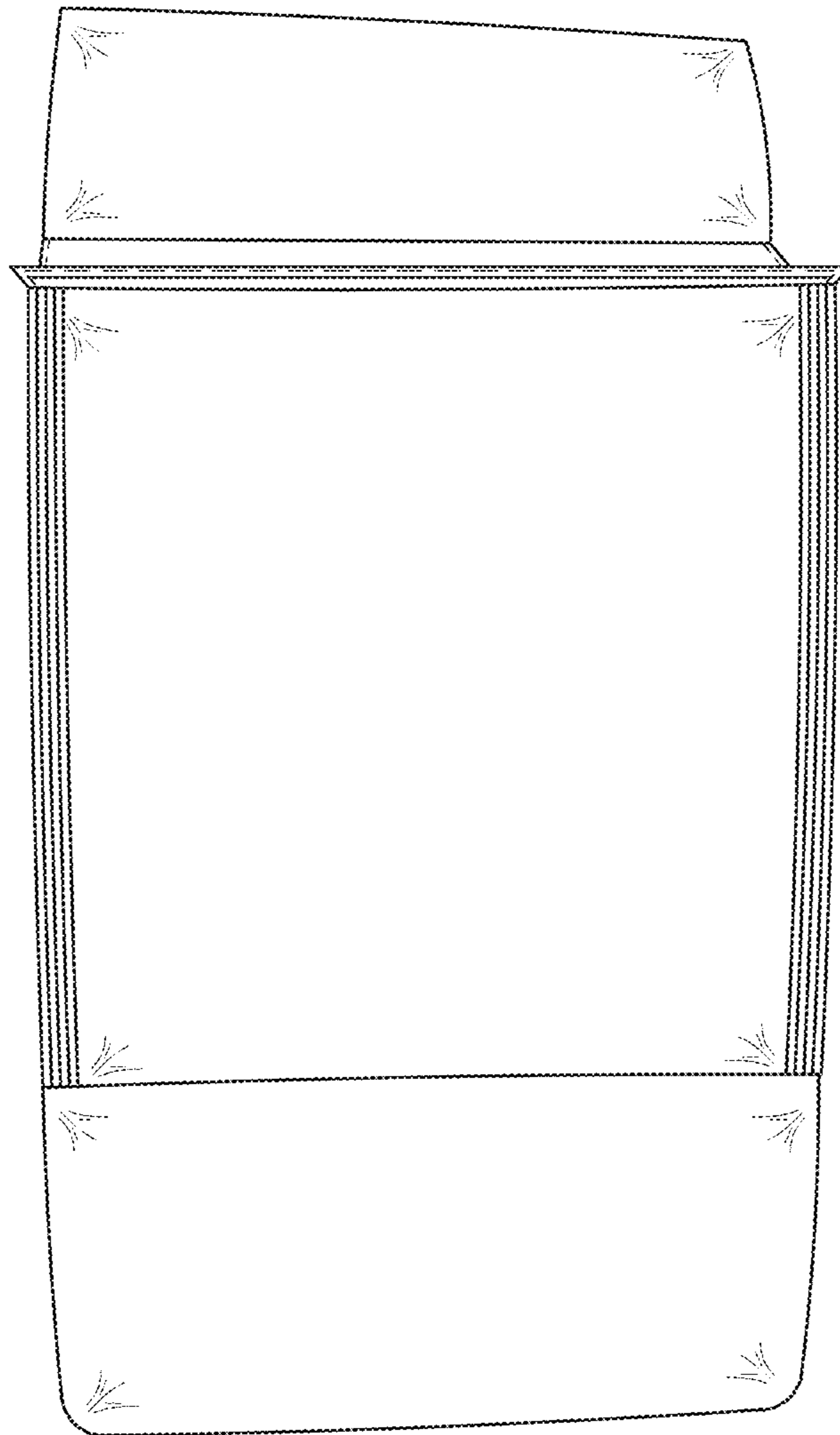

FIG. 2

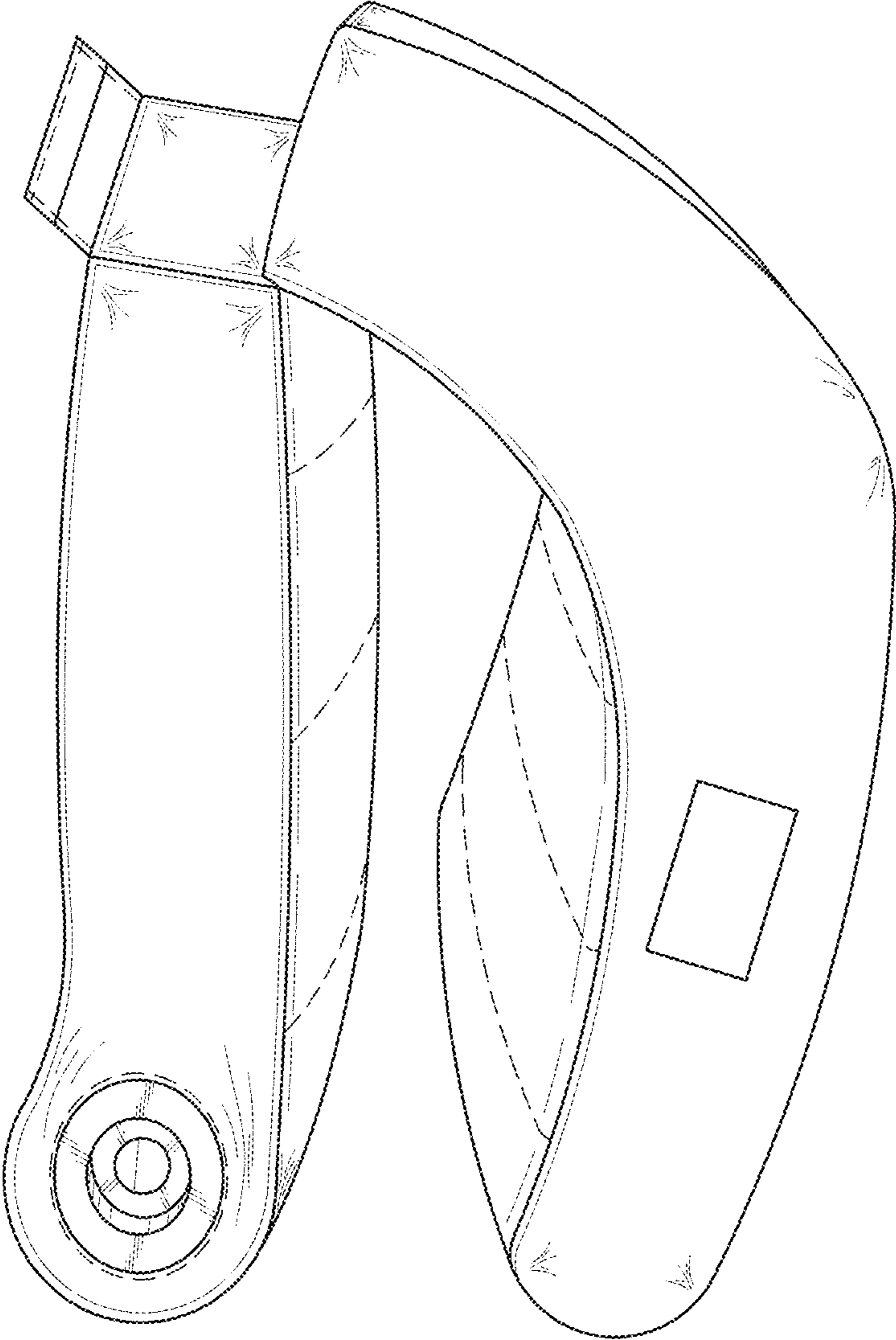

FIG. 3

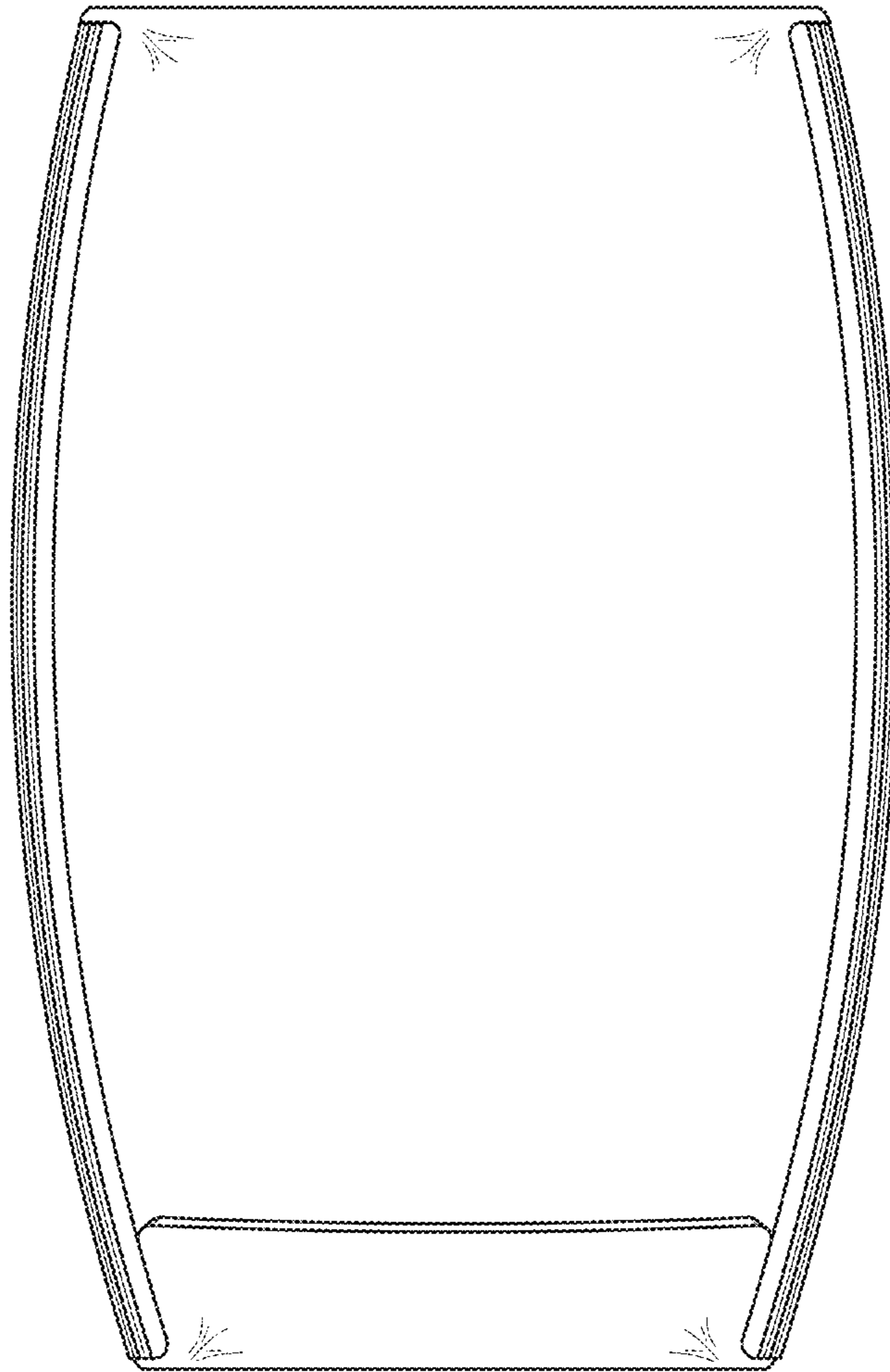

FIG. 4

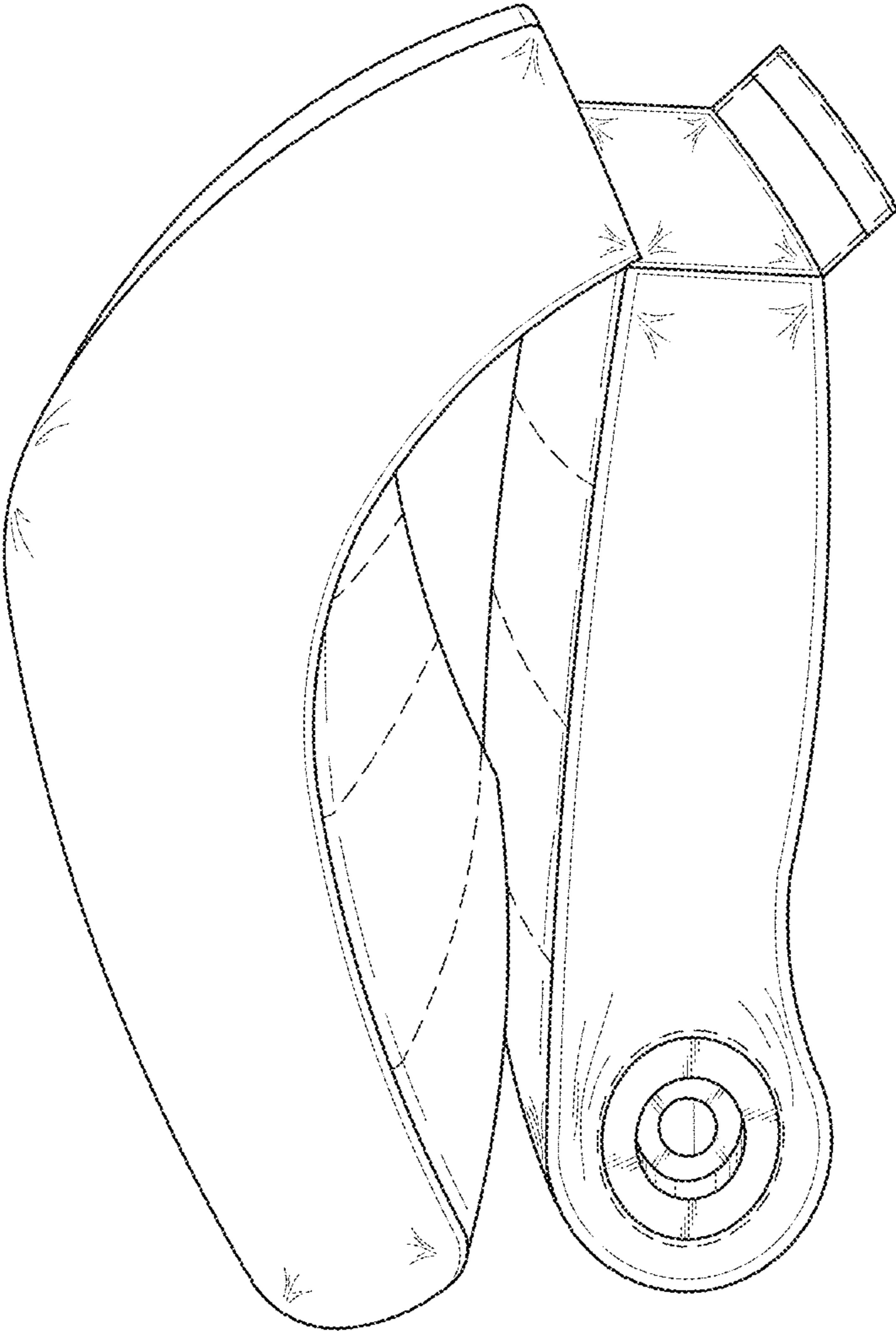

FIG. 5

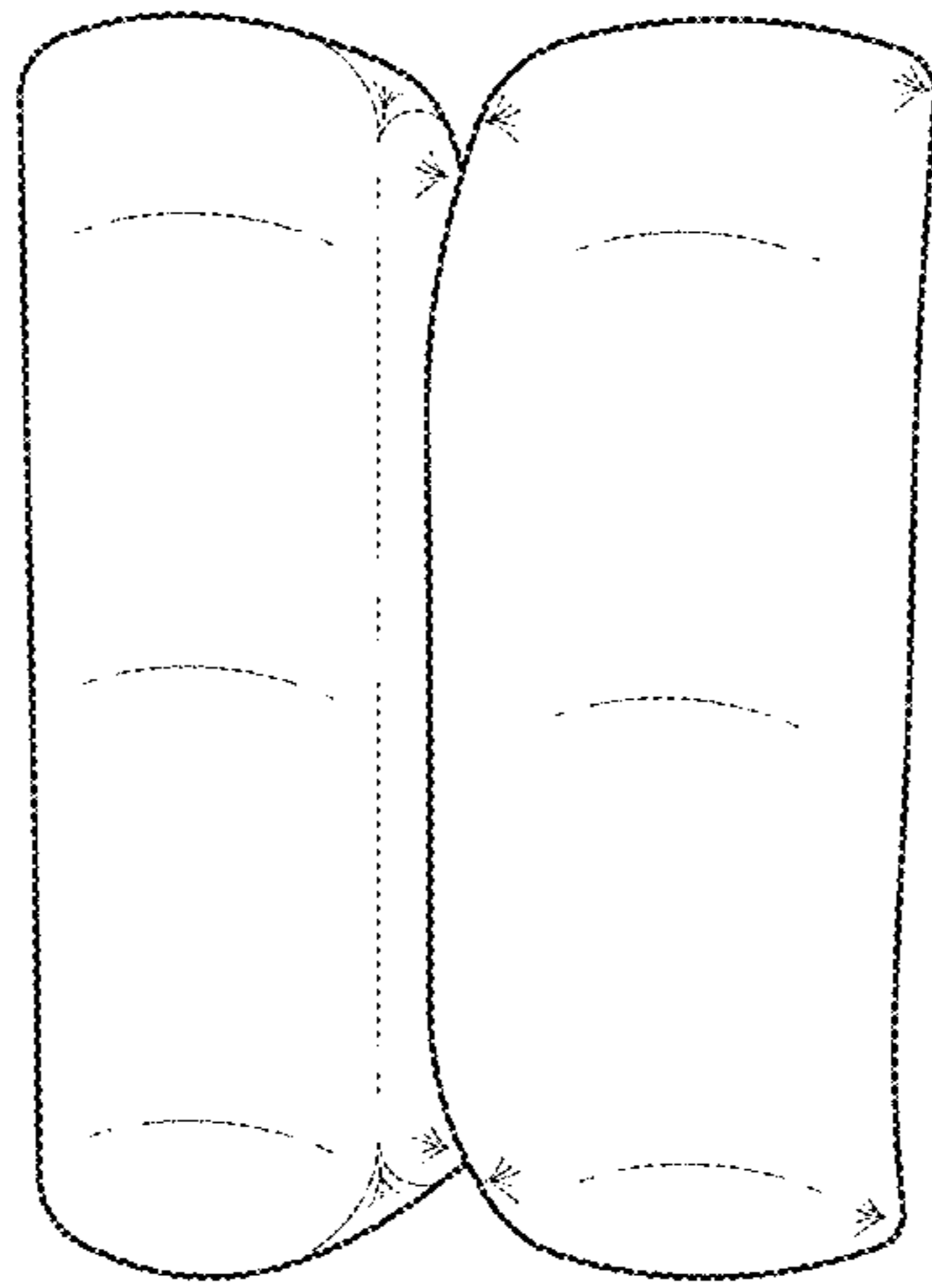

FIG. 6

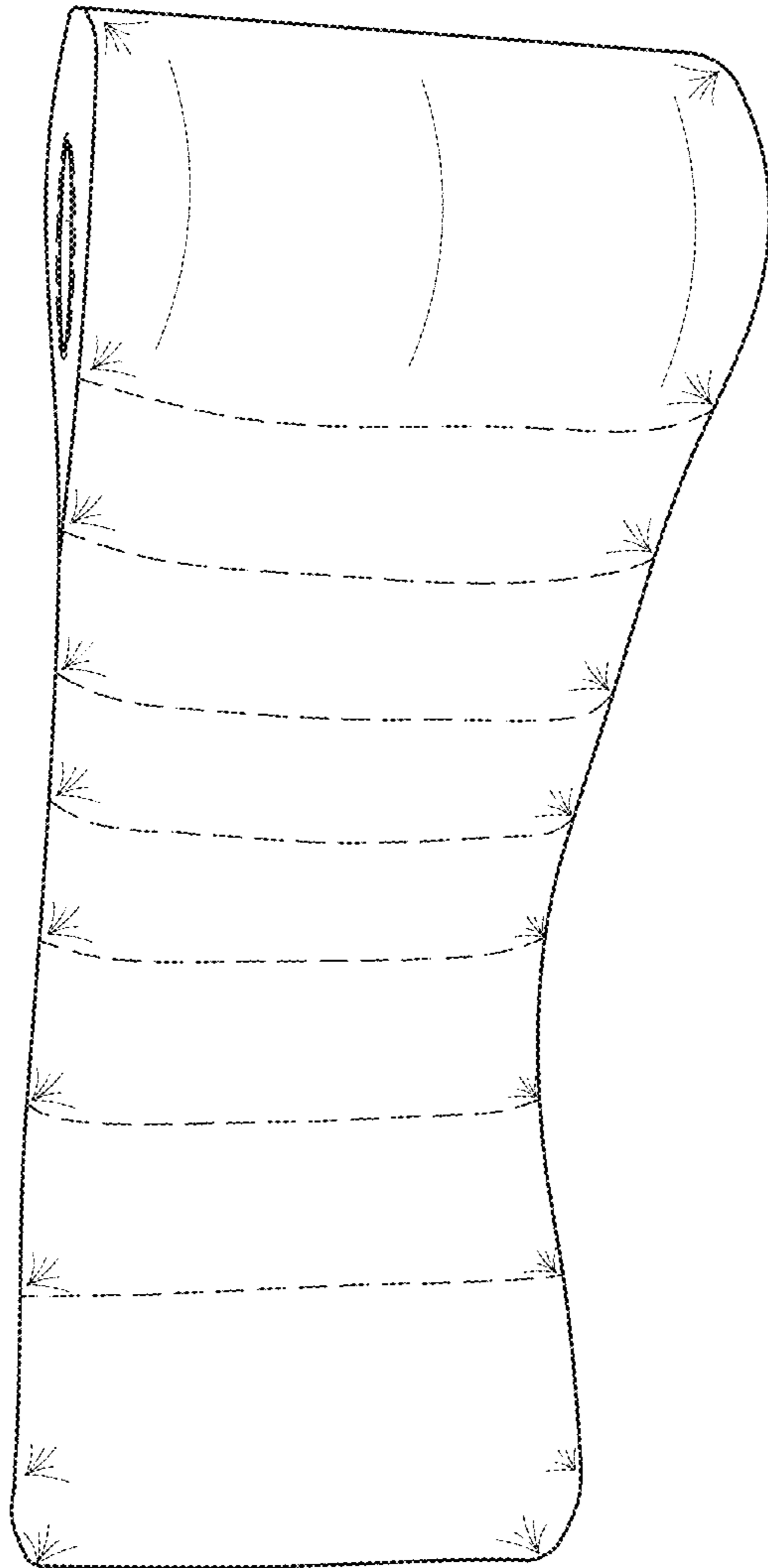

FIG. 7

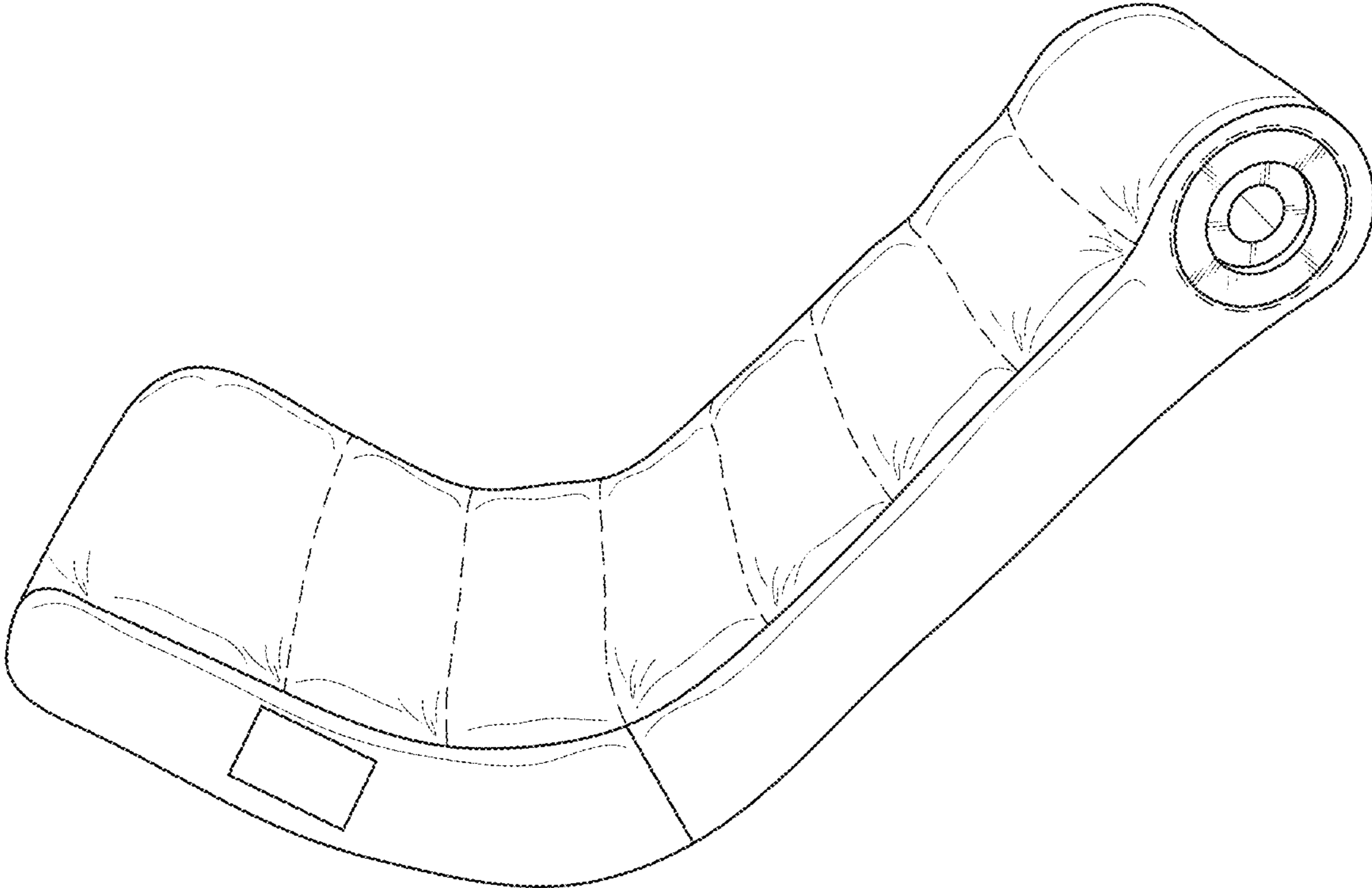

FIG. 8

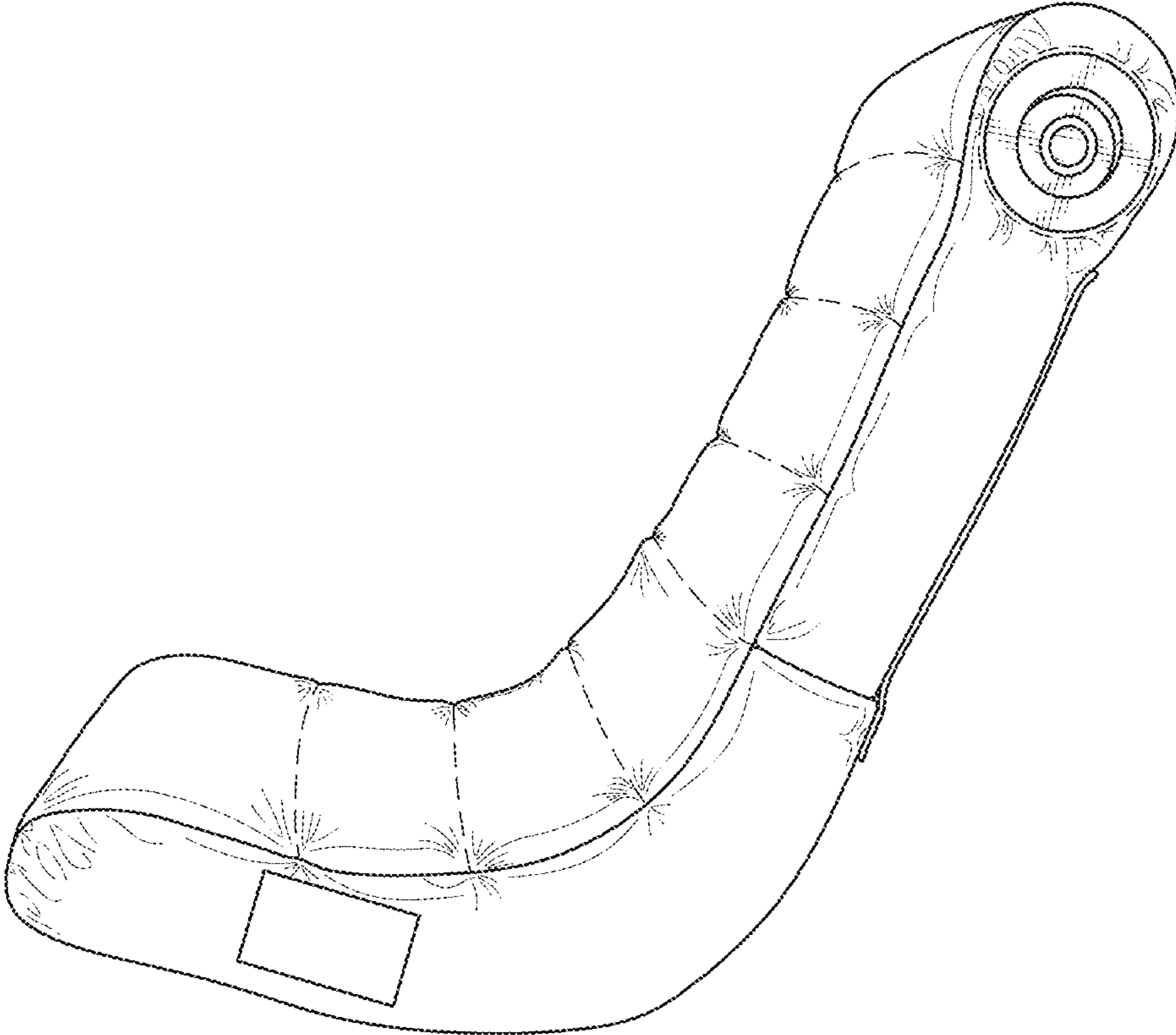

FIG. 9

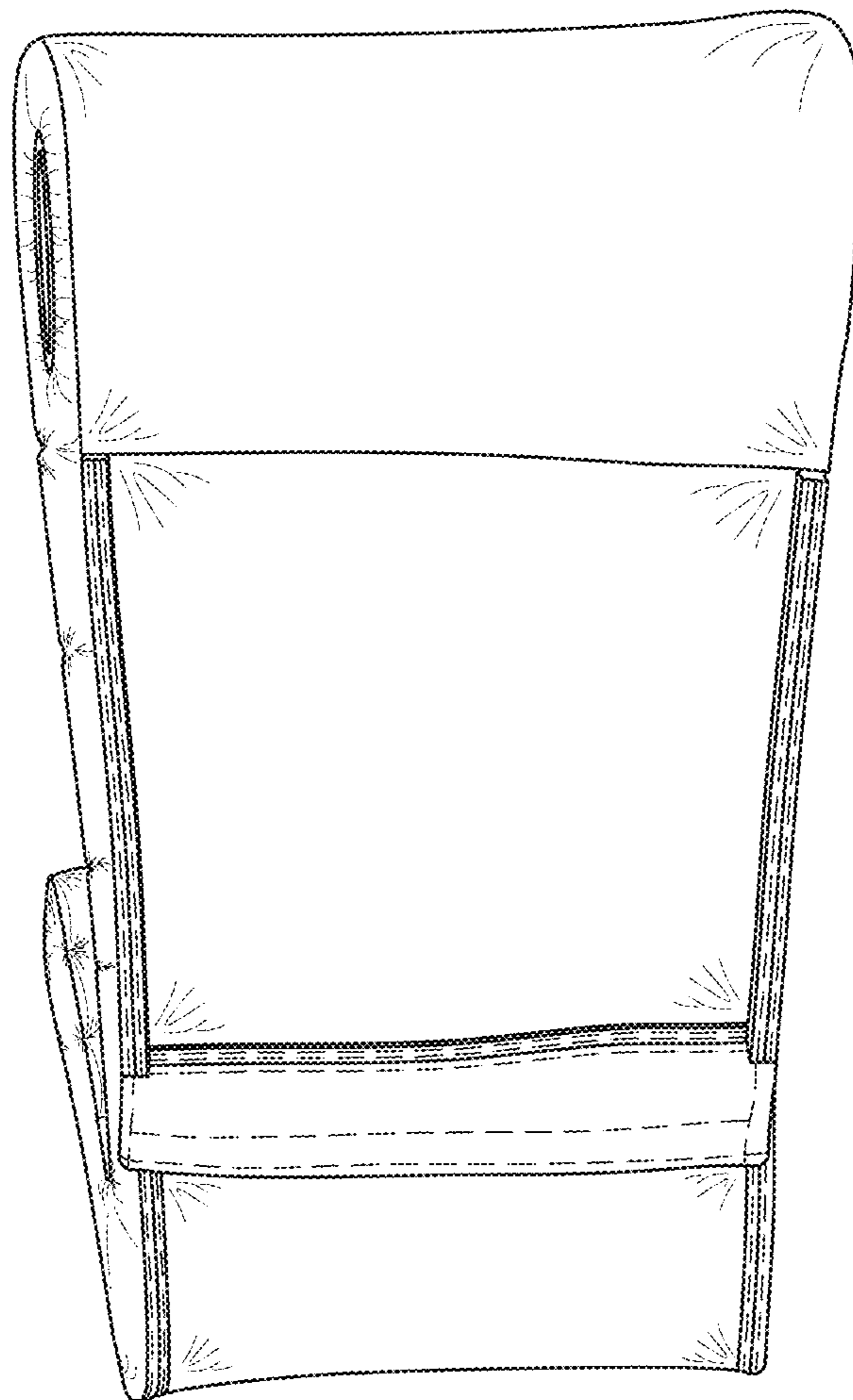

FIG. 10

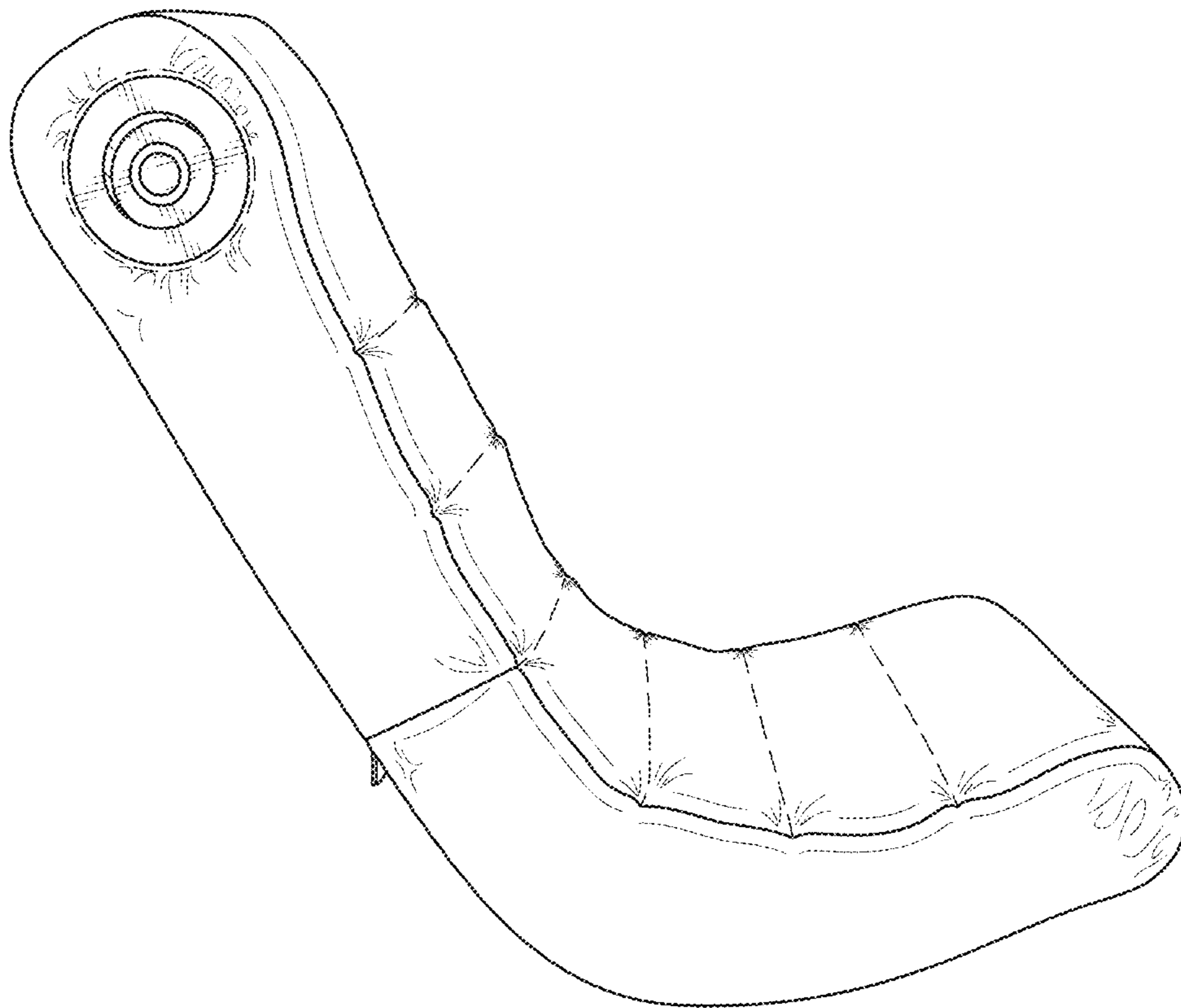

FIG. 11

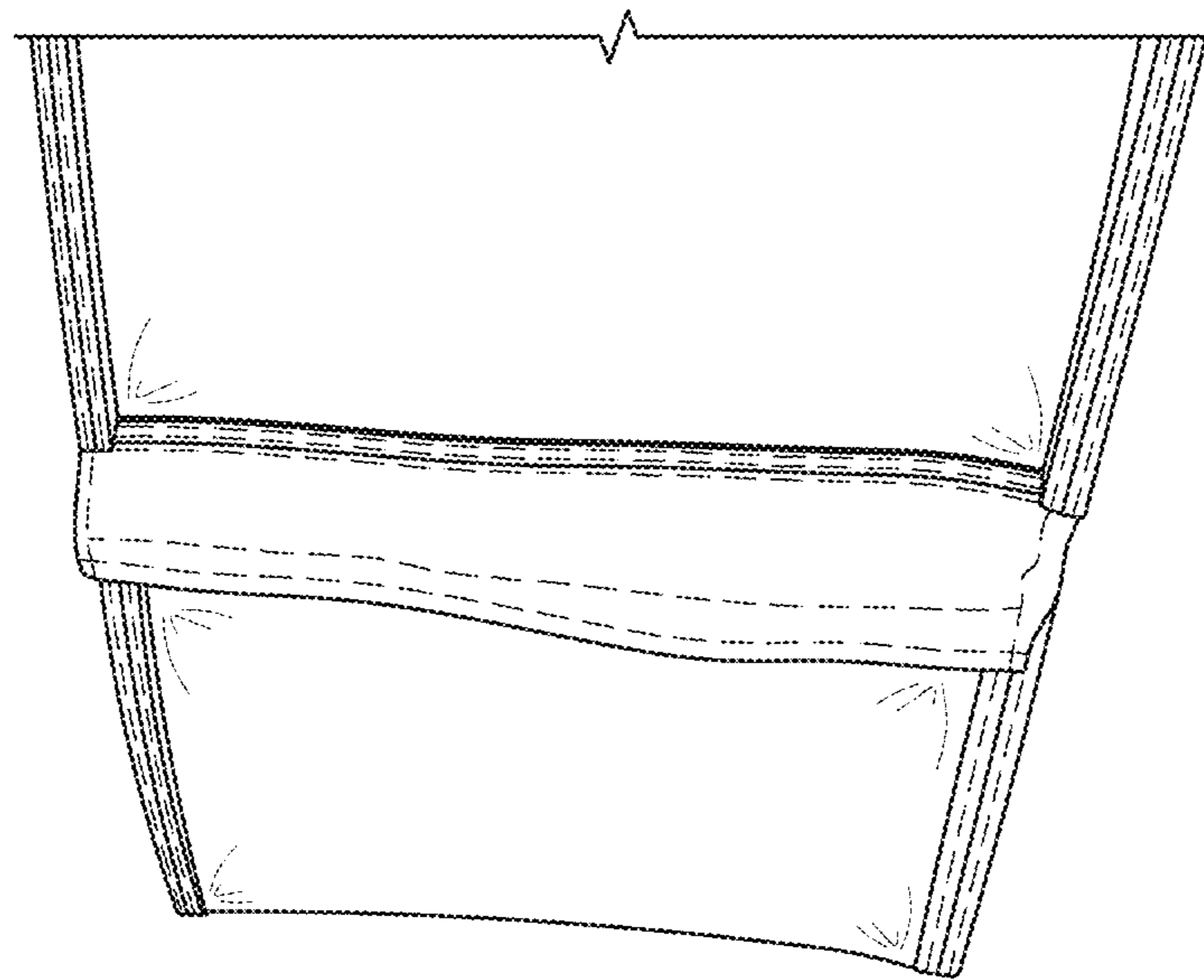

FIG. 12

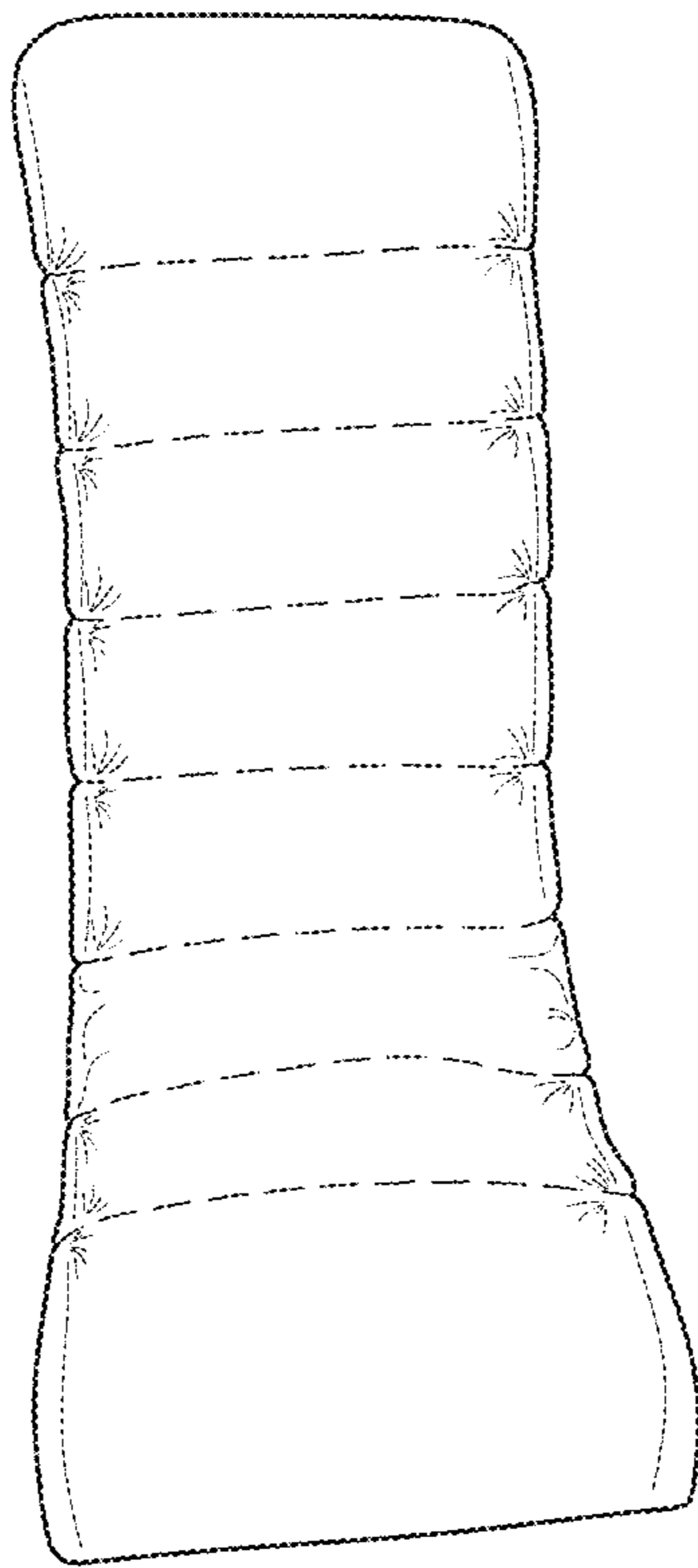

FIG. 13