



US00D889092S

(12) **United States Design Patent**
Verfl et al.

(10) **Patent No.:** **US D889,092 S**
(45) **Date of Patent:** **** Jul. 7, 2020**

- (54) **SHOE SOLE**
- (71) Applicant: **Cole Haan LLC**, New York, NY (US)
- (72) Inventors: **Mattias Verfl**, Greenland, NH (US);
Jeffrey Mokos, Greenland, NH (US)
- (73) Assignee: **COLE HAAN LLC**, New York, NY (US)

(**) Term: **15 Years**
(21) Appl. No.: **29/672,123**

- (22) Filed: **Dec. 3, 2018**
- (51) **LOC (12) Cl.** **02-04**
- (52) **U.S. Cl.**
USPC **D2/954**; D2/947; D2/951; D2/960
- (58) **Field of Classification Search**
USPC D2/902, 906, 908, 916, 918, 925,
D2/946-962, 977; 36/1, 1.5, 3 B, 22 R,
36/24.5, 25 R, 28, 32 R, 34 R, 59 C,
36/67 A, 101-107, 114-116, 117.3, 117.4,
36/124-136
CPC A43B 13/00; A43B 13/02; A43B 13/023;
A43B 13/026; A43B 13/04; A43B 13/08;
A43B 13/10; A43B 13/12; A43B 13/14;
A43B 13/141; A43B 13/143; A43B
13/16; A43B 13/18; A43B 13/181; A43B
13/187; A43B 13/189; A43B 13/20; A43B
13/22; A43B 13/223; A43B 13/24; A43B
13/28; A43B 13/30; A43B 13/32; A43B
13/34; A43B 13/36

See application file for complete search history.

(56) **References Cited**

U.S. PATENT DOCUMENTS

- 2,394,704 A * 2/1946 Loewer A43B 13/08
36/33
- D291,147 S * 8/1987 Kelley 36/32 R

- D294,537 S * 3/1988 Le D2/960
- D467,060 S * 12/2002 Randesi D2/951
- D565,283 S * 4/2008 Smith D2/902

(Continued)

FOREIGN PATENT DOCUMENTS

- CN 202680706 * 1/2013 A43B 13/22

OTHER PUBLICATIONS

Generation Zerogrand, ColeHaan.com, [online], [site visited Feb. 25, 2020]. <URL: <https://www.colehaan.com/generation-zero-grand-ironstone-stitchlite/C30170.html>> (Year: 2020).*

(Continued)

Primary Examiner — T Chase Nelson
Assistant Examiner — Jonathan J. Han
(74) *Attorney, Agent, or Firm* — Thompson Coburn LLP

(57) **CLAIM**

The ornamental design for a shoe sole, as shown and described.

DESCRIPTION

FIG. 1 is a first perspective view of a shoe sole showing our new design;
FIG. 2 is a second perspective view thereof;
FIG. 3 is a third perspective view thereof;
FIG. 4 is a fourth perspective view thereof;
FIG. 5 is a front view thereof;
FIG. 6 is a rear view thereof;
FIG. 7 is a lateral side view thereof;
FIG. 8 is a medial side view thereof;
FIG. 9 is a top view thereof; and,
FIG. 10 is a bottom view thereof.

The broken lines in the figures are used to depict portions that form no part of the claimed design. The broken lines immediately adjacent to the photographic area represent boundaries that also form no part of the claimed design. Color is not claimed and forms no part of the claimed design.

1 Claim, 10 Drawing Sheets

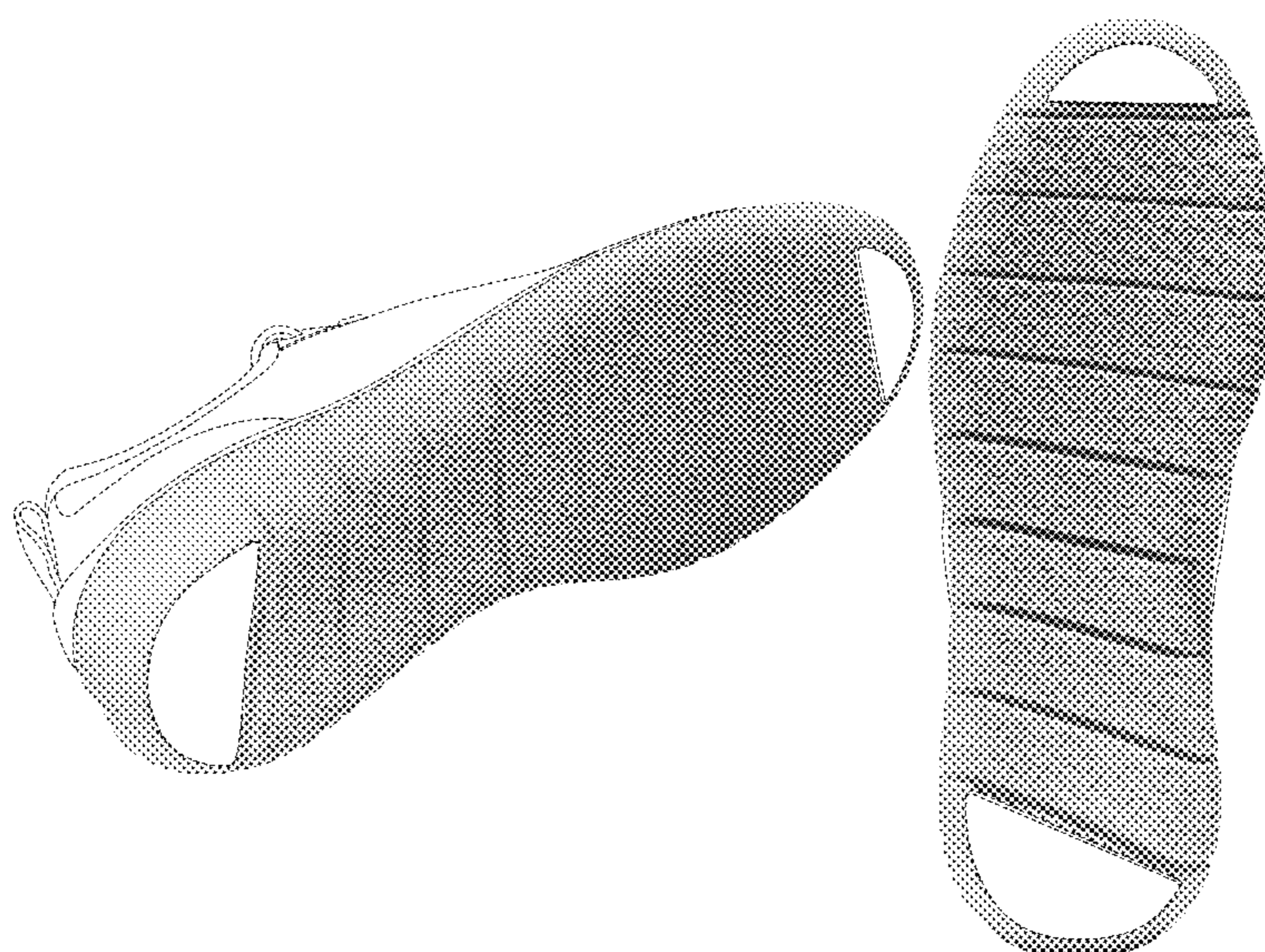

(56)

References Cited

U.S. PATENT DOCUMENTS

D577,883 S * 10/2008 Link D2/951
 8,065,818 B2 11/2011 Greene et al.
 D671,305 S * 11/2012 Escobar D2/947
 D730,034 S * 5/2015 Henderson D2/951
 D730,035 S 5/2015 Henderson
 D737,552 S * 9/2015 Guichot D2/908
 D740,007 S * 10/2015 Lan D2/951
 D747,859 S 1/2016 Henderson et al.
 D748,386 S 2/2016 Henderson et al.
 D752,848 S * 4/2016 Santos D2/929
 D753,381 S * 4/2016 Ostapenko D2/947
 D768,367 S 10/2016 Henderson et al.
 D778,565 S * 2/2017 Sars D2/960
 D787,792 S * 5/2017 Caron D2/951
 D800,433 S * 10/2017 Kuerbis D2/957
 D804,159 S * 12/2017 Allemann D2/960
 D809,758 S * 2/2018 Tæstensen D2/951
 D816,308 S * 5/2018 Boys D2/945
 D817,609 S * 5/2018 Boys D2/945
 9,999,274 B2 * 6/2018 Henderson A43B 13/141
 D822,966 S * 7/2018 Thompson D2/953
 D843,098 S * 3/2019 Natowich McPhee D2/960
 D845,595 S * 4/2019 Swegle D2/957
 D845,598 S * 4/2019 Loveder D2/957

D852,485 S * 7/2019 Gress D2/960
 D855,295 S * 8/2019 Della Valle D2/908
 D858,045 S * 9/2019 Tæstensen D2/908
 D862,061 S * 10/2019 Wilkinson D2/960
 D869,136 S * 12/2019 Natowich McPhee D2/957
 2015/0101215 A1 * 4/2015 Henderson A43B 13/125
 36/103
 2018/0008006 A1 * 1/2018 Boys D04B 1/104
 2018/0325215 A1 11/2018 Tæstensen

OTHER PUBLICATIONS

Cole Haan Men's Zerogrand Stitchlite Oxford, Amazon.com, Date first listed on Amazon: Feb. 8, 2018, [online], [site visited Feb. 25, 2020]. <URL: https://www.amazon.com/Cole-Haan-Zerogrand-Stitchlite-Ironstone/dp/B073HVNLSG/ref=pd_sbs_309_1/132-2524759-0679644?_encoding=UTF8&pd_rd_i=B073J1H5V4&pd> (Year: 2018).*

GKTINOO Summer Shoes Woman Genuine Leather Soft Outsole Closed Toe Sandals Casual Flat Women Shoes New Fashion Women Sandals, Touchy-Style.com, [online], [site visited Feb. 25, 2020]. <URL: <https://www.touchy-style.com/products/gktinoo-summer-shoes-woman-genuine-leather-soft-outsole-clos>> (Year: 2020).*

* cited by examiner

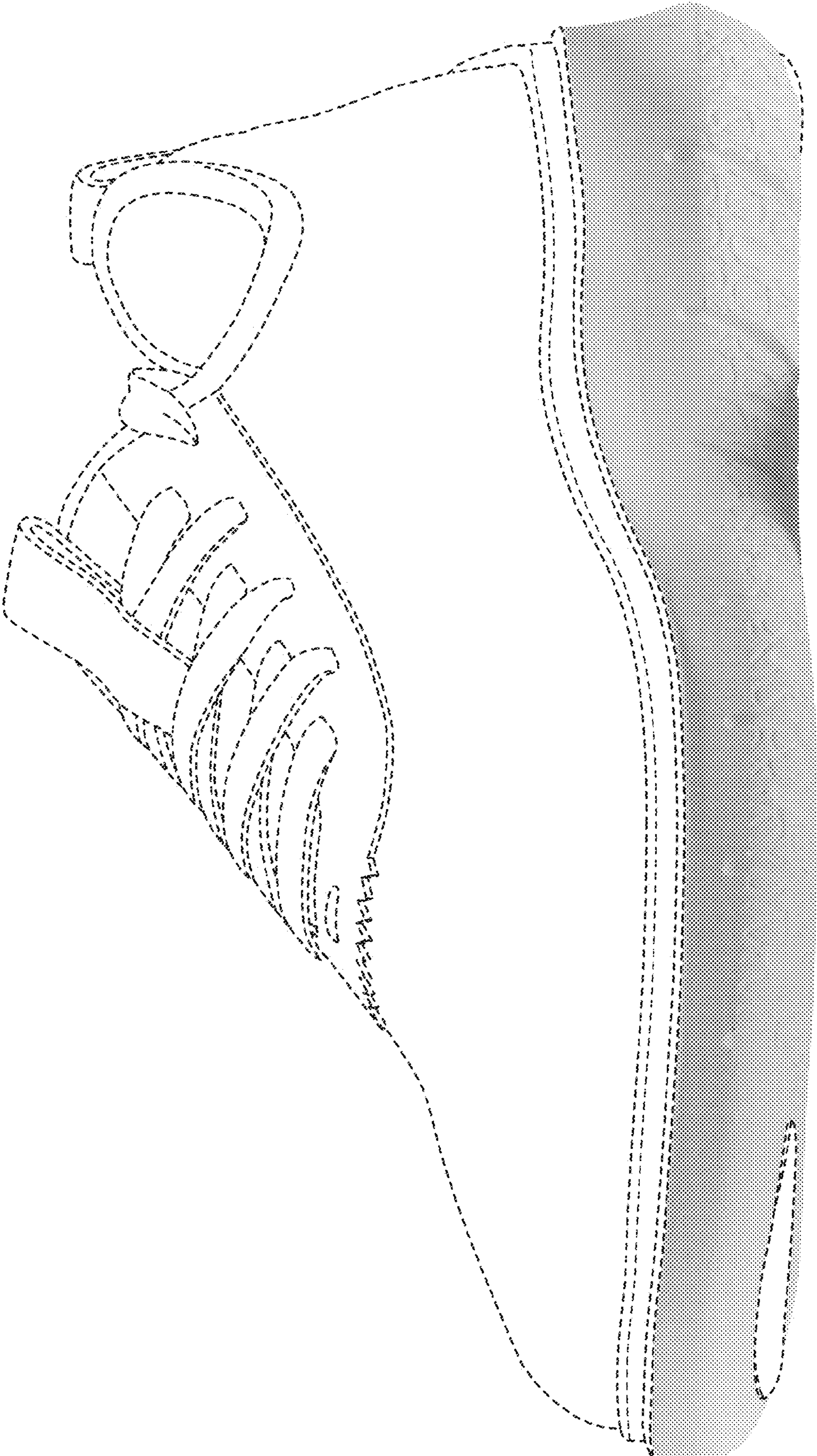

FIG. 1

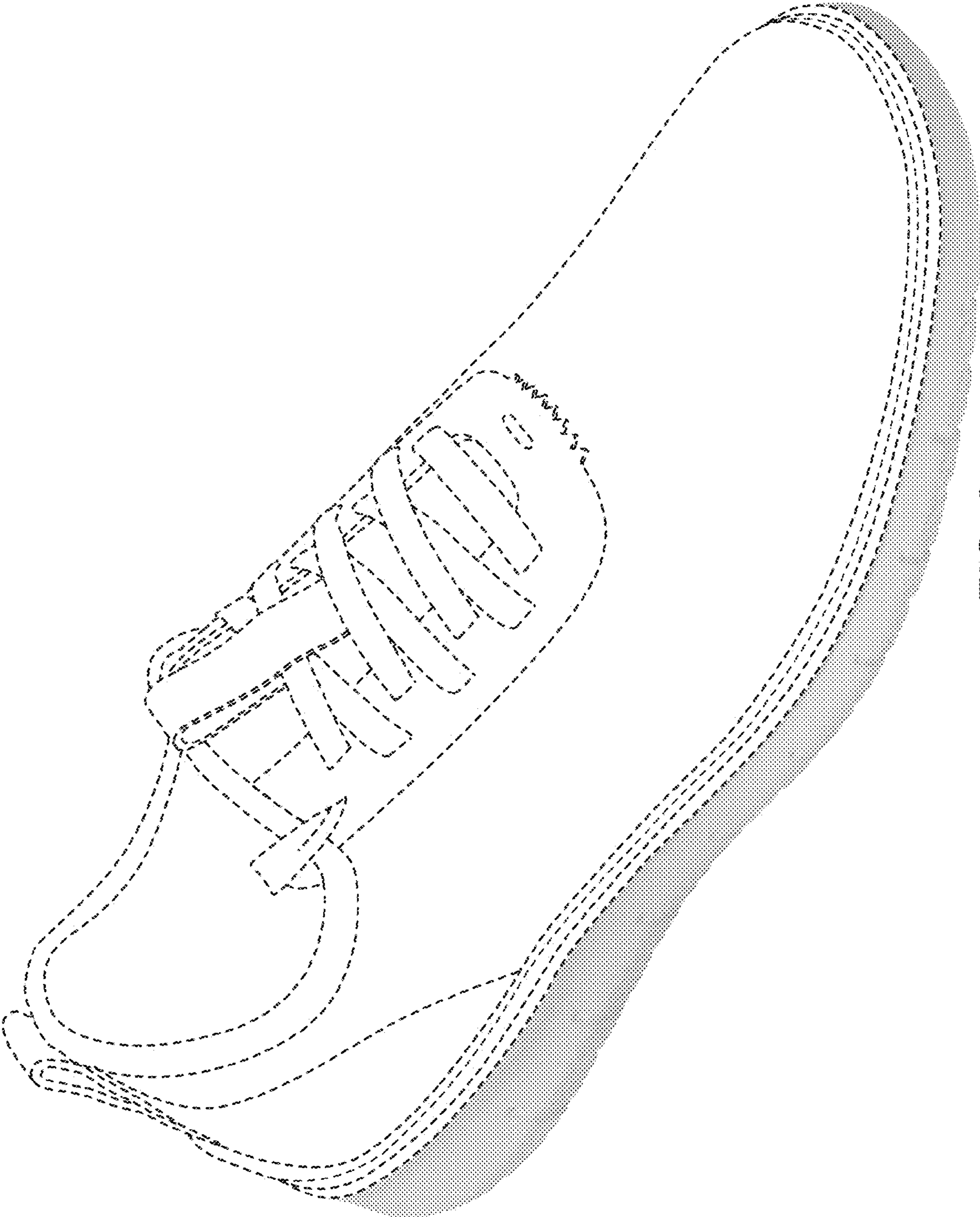

FIG. 2

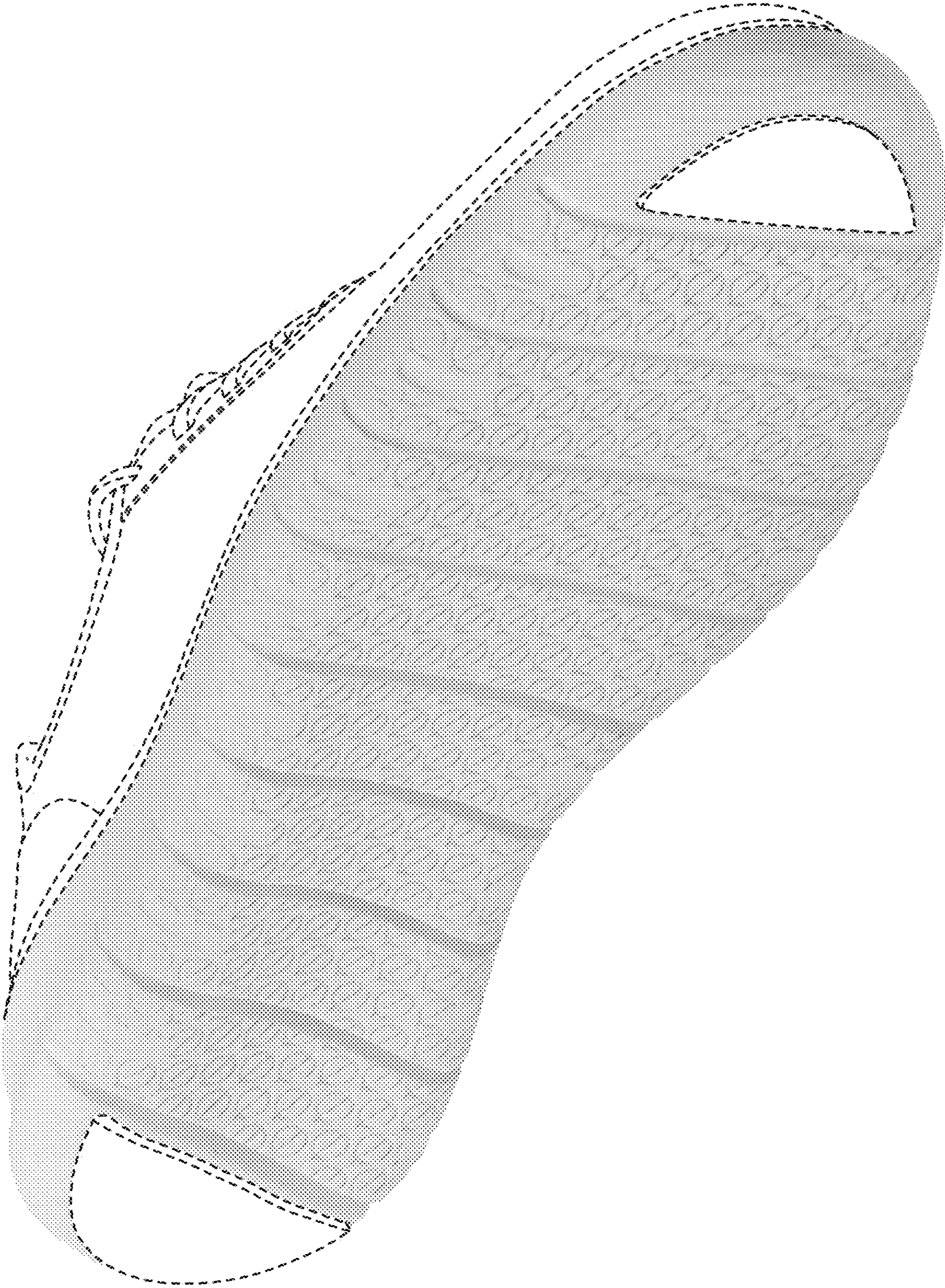

FIG. 3

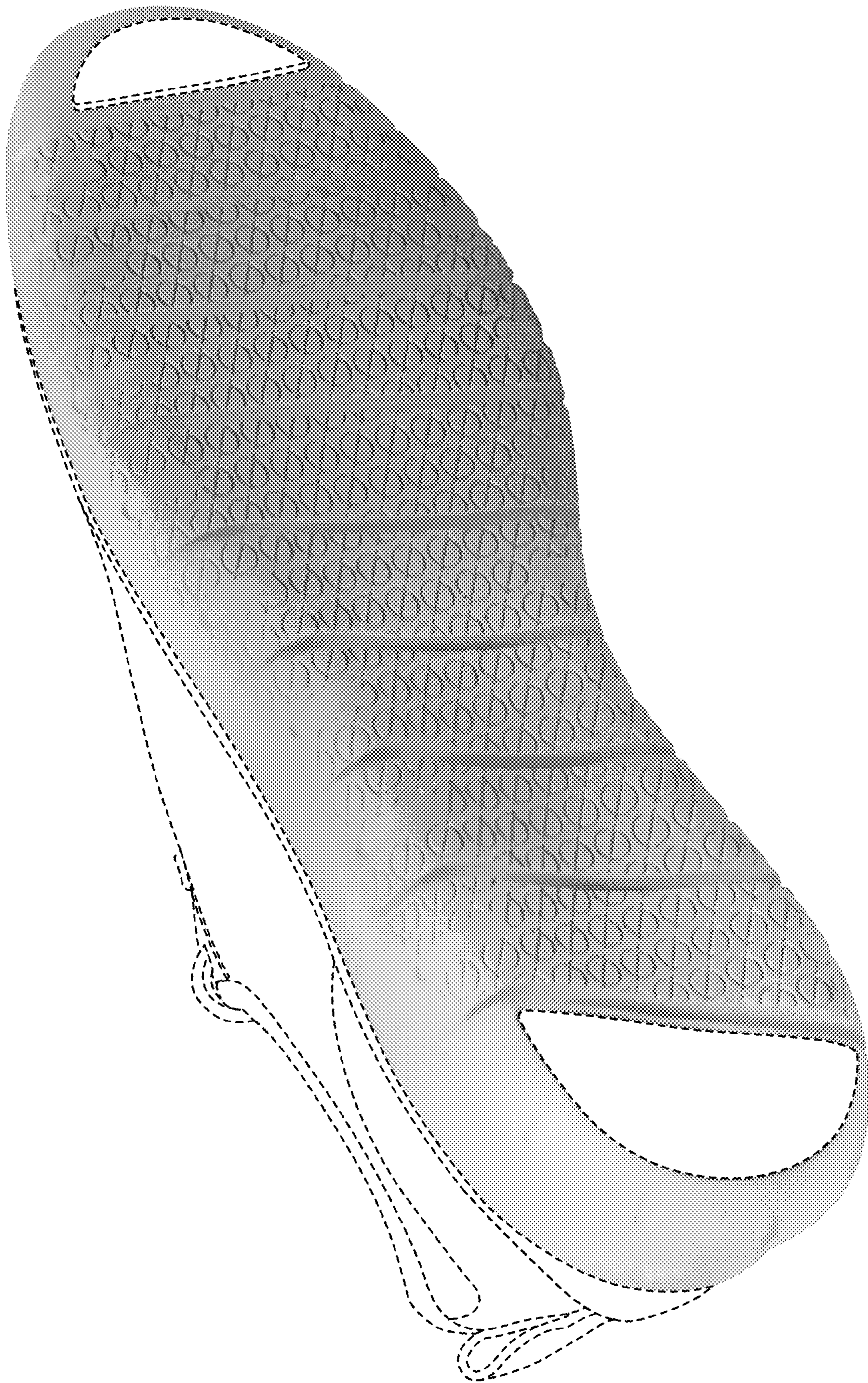

FIG. 4

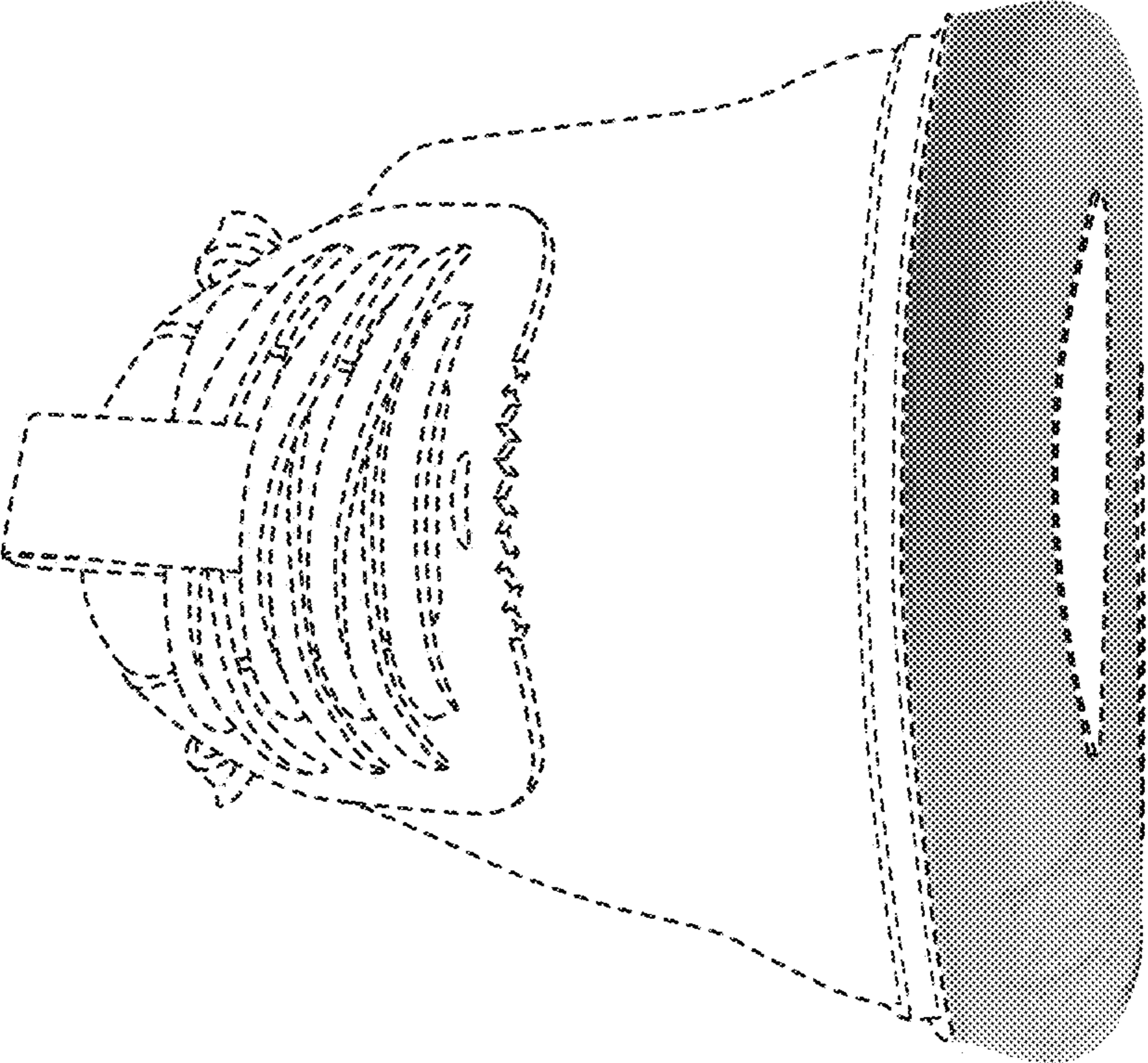

FIG. 5

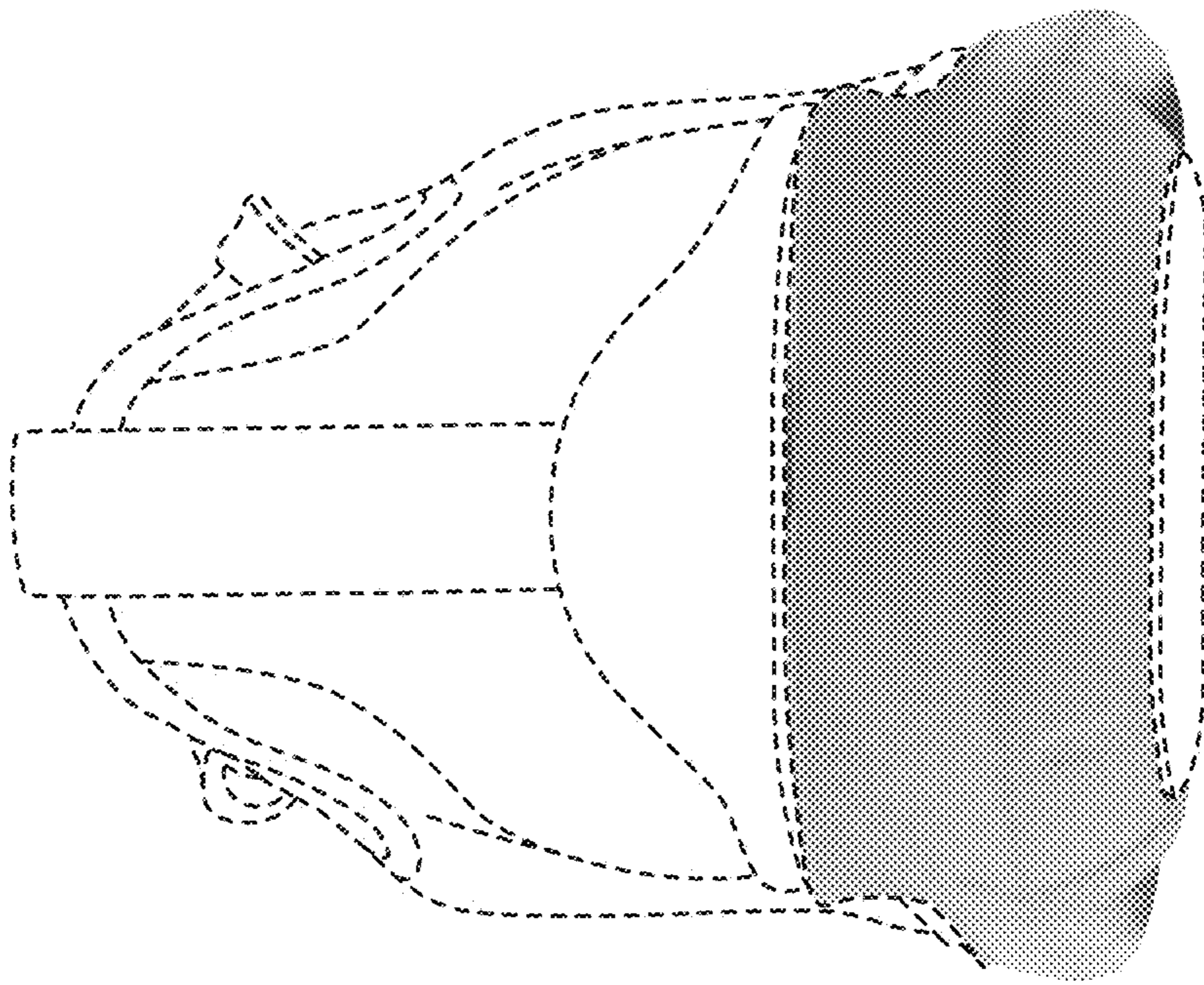

FIG. 6

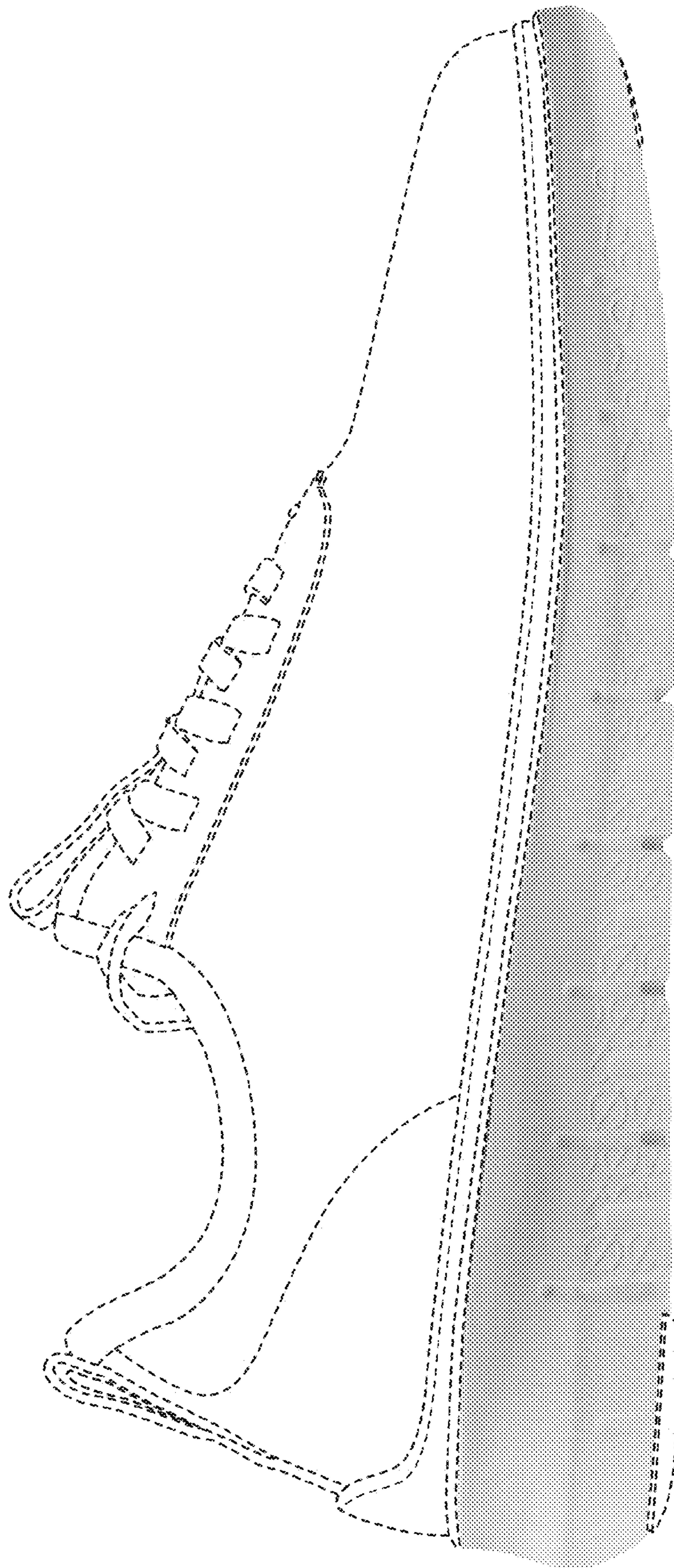

FIG. 7

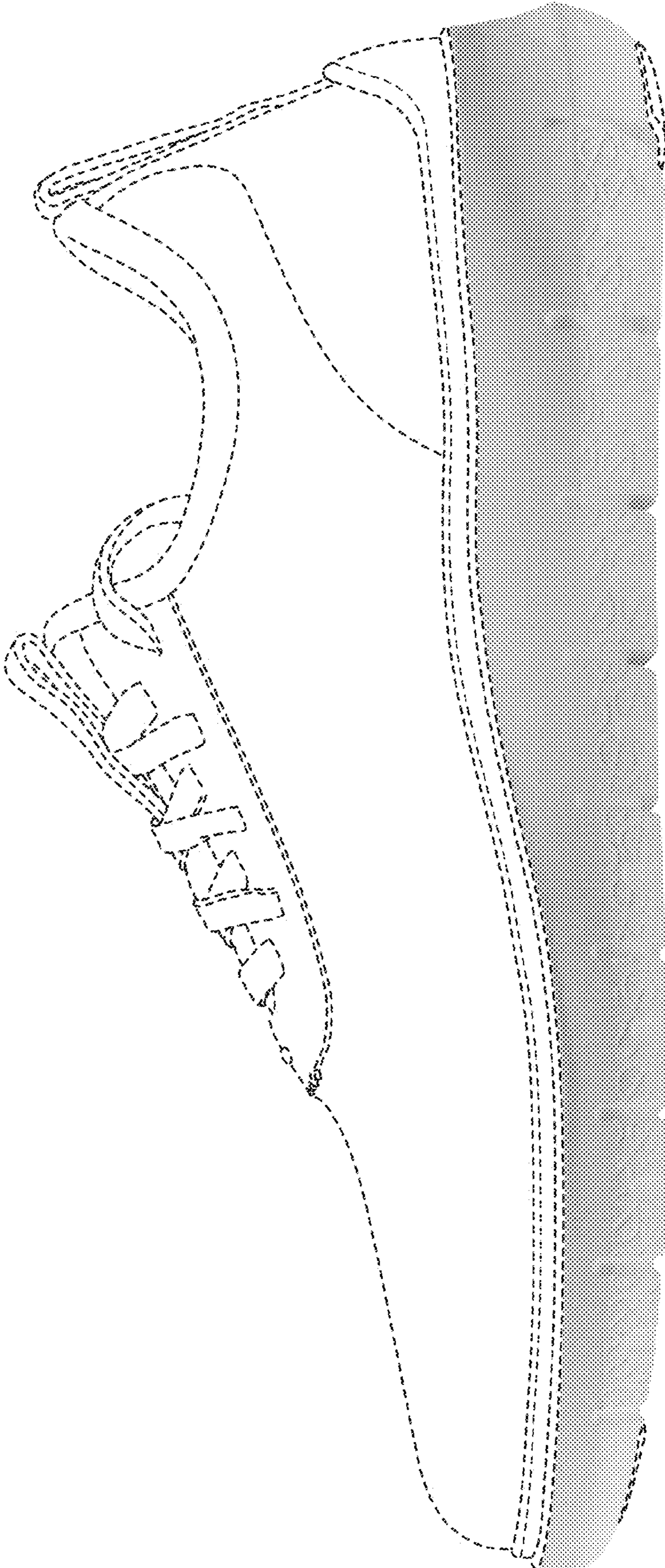

FIG. 8

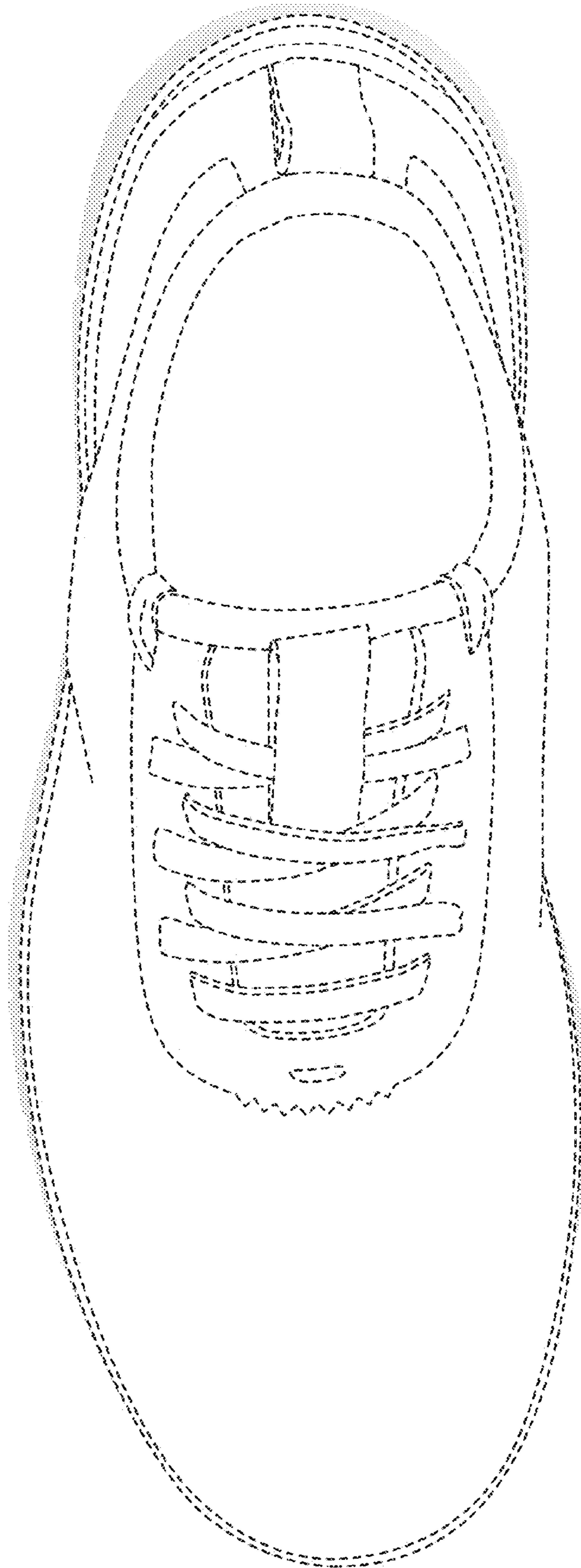

FIG. 9



FIG. 10