



US00D889084S

(12) **United States Design Patent**
Daiber

(10) **Patent No.:** **US D889,084 S**

(45) **Date of Patent:** **** Jul. 7, 2020**

(54) **SOLE**

(71) Applicant: **adidas AG**, Herzogenaurach (DE)

(72) Inventor: **Nicholas John Daiber**, Highland, IL (US)

(73) Assignee: **adidas AG**, Herzogenaurach (DE)

(**) Term: **15 Years**

(21) Appl. No.: **29/671,944**

(22) Filed: **Nov. 30, 2018**

(51) **LOC (12) Cl.** **02-04**

(52) **U.S. Cl.**

USPC **D2/947**; D2/957; D2/960

(58) **Field of Classification Search**

USPC D2/902, 906, 908, 916, 918, 925,
D2/946-962, 977; 36/1, 1.5, 3 B, 22 R,
36/24.5, 25 R, 28, 32 R, 34 R, 59 C,
36/67 A, 101-107, 114-116, 117.3, 117.4,
36/124-136

CPC A43B 13/00; A43B 13/02; A43B 13/023;
A43B 13/026; A43B 13/04; A43B 13/08;
A43B 13/10; A43B 13/12; A43B 13/14;
A43B 13/141; A43B 13/143; A43B
13/16; A43B 13/18; A43B 13/181; A43B
13/187; A43B 13/189; A43B 13/20; A43B
13/22; A43B 13/223; A43B 13/24; A43B
13/28; A43B 13/30; A43B 13/32; A43B
13/34; A43B 13/36

See application file for complete search history.

(56) **References Cited**

U.S. PATENT DOCUMENTS

D404,897 S * 2/1999 Marshall D2/951
D407,892 S * 4/1999 Gaudio D2/951
D411,910 S * 7/1999 Cessor D2/951
D433,558 S * 11/2000 Matis D2/947

D480,541 S * 10/2003 Galway D2/951
D532,585 S * 11/2006 McDonald D2/959
D561,438 S * 2/2008 Belley D2/953
D572,462 S * 7/2008 Hatfield D2/977
D589,692 S * 4/2009 McClaskie D2/951
D634,922 S * 3/2011 Pauk D2/946

(Continued)

OTHER PUBLICATIONS

Kamanda Shoes, Adidas.com, [online], [site visited Feb. 19, 2020].
<URL: <https://www.adidas.com/us/kamanda-shoes/EE5649.html>>
(Year: 2020).*

(Continued)

Primary Examiner — T Chase Nelson

Assistant Examiner — Jonathan J. Han

(74) *Attorney, Agent, or Firm* — Sterne, Kessler,
Goldstein & Fox P.L.L.C.

(57) **CLAIM**

The ornamental design for a sole, as shown and described.

DESCRIPTION

FIG. 1 is a top front perspective view of a sole showing the claimed design;

FIG. 2 is a bottom rear perspective view thereof;

FIG. 3 is a front view thereof;

FIG. 4 is a rear view thereof;

FIG. 5 is a left side view thereof;

FIG. 6 is a right side view thereof;

FIG. 7 is a top view thereof; and,

FIG. 8 is a bottom view thereof.

The dashed broken lines in the figures show portions of the sole or environment that form no part of the claimed design.

The dot-dash broken lines in the figures show boundaries that form no part of the claimed design.

The shade lines in the figures show contour and not surface ornamentation.

1 Claim, 8 Drawing Sheets

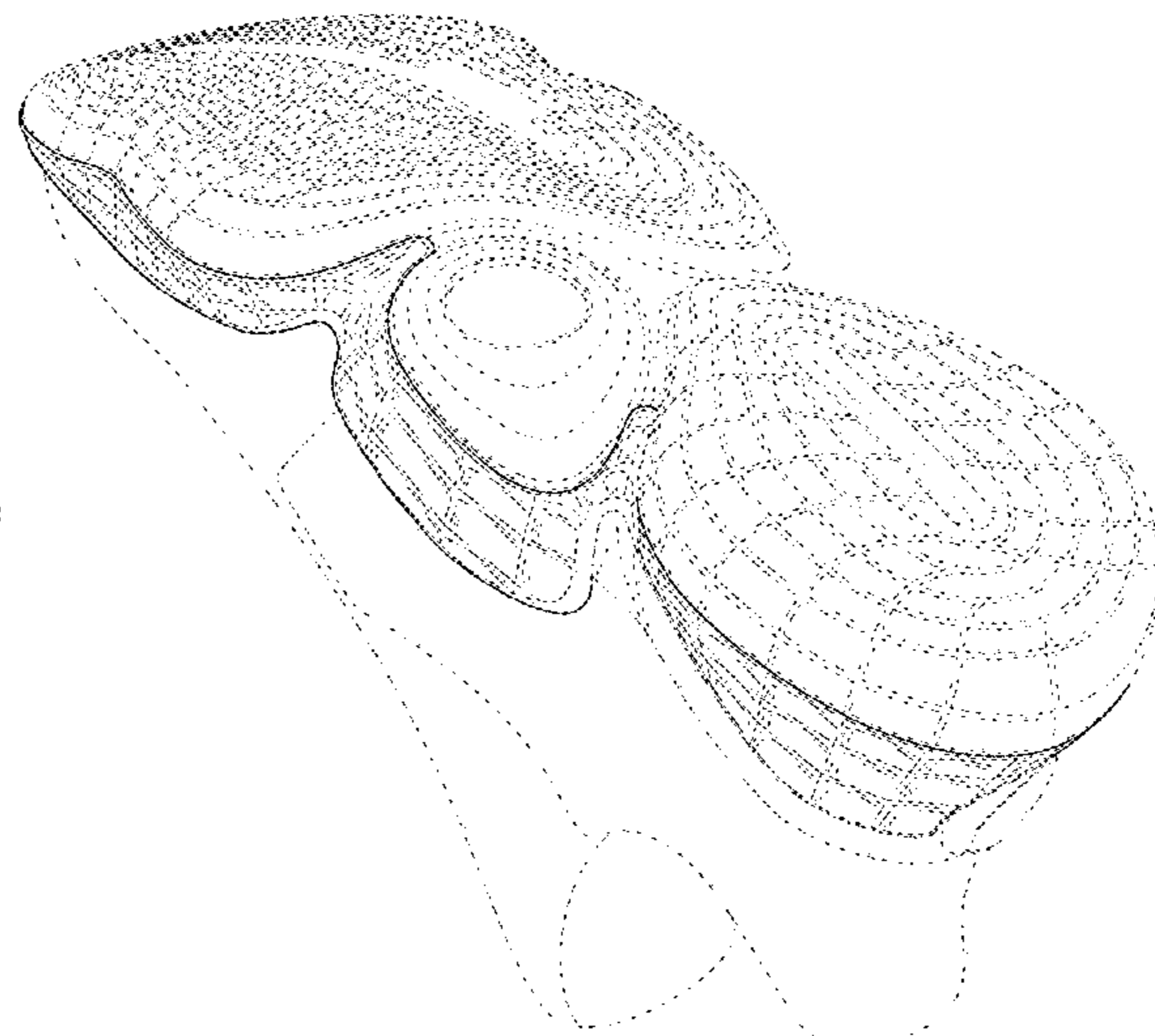
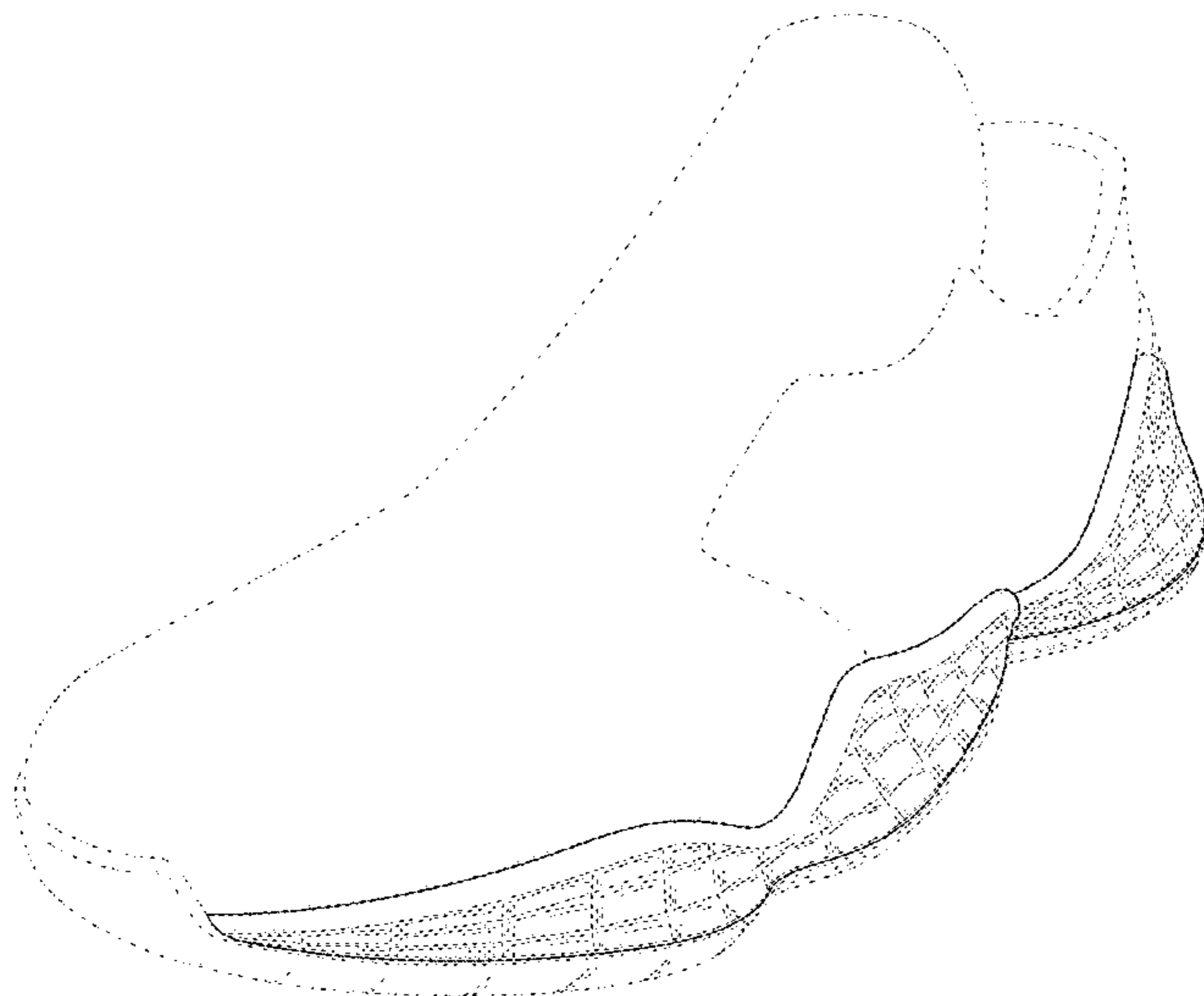

(56)

References Cited

U.S. PATENT DOCUMENTS

D669,254 S * 10/2012 Vestuti D2/947
D674,173 S * 1/2013 Bramani D2/902
D686,402 S * 7/2013 Portzline D2/951
D686,404 S * 7/2013 McCourt D2/951
D744,212 S * 12/2015 Boudreau D2/951
D767,861 S * 10/2016 Wattimena D2/947
D784,666 S * 4/2017 Lok D2/947
D804,157 S * 12/2017 Pierone D2/947
D825,163 S * 8/2018 Montross D2/957
D829,423 S * 10/2018 Robusti D2/947
D833,123 S * 11/2018 Sassi D2/908
D841,300 S * 2/2019 Albrecht D2/959
D841,964 S * 3/2019 Kaiserswerth D2/957
D845,597 S * 4/2019 Barnes D2/957
D851,873 S * 6/2019 Maier D2/944
D854,292 S * 7/2019 Mokos D2/953
D854,797 S * 7/2019 Mokos D2/953
D857,362 S * 8/2019 Thompson D2/959
D858,066 S * 9/2019 Hatfield D2/959
D862,051 S * 10/2019 Goussev D2/947
D864,536 S * 10/2019 Mokos D2/953

OTHER PUBLICATIONS

Streetball Shoes, Adidas.com, [online], [site visited Feb. 20, 2020].
<URL: <https://www.adidas.com/us/streetball-shoes/EF6984.html>> (Year: 2020).*

Icon V Cleats, Adidas.com, [online], [site visited Feb. 20, 2020].
<URL: <https://www.adidas.com/us/icon-v-cleats/G28238.html>> (Year: 2020).*

* cited by examiner

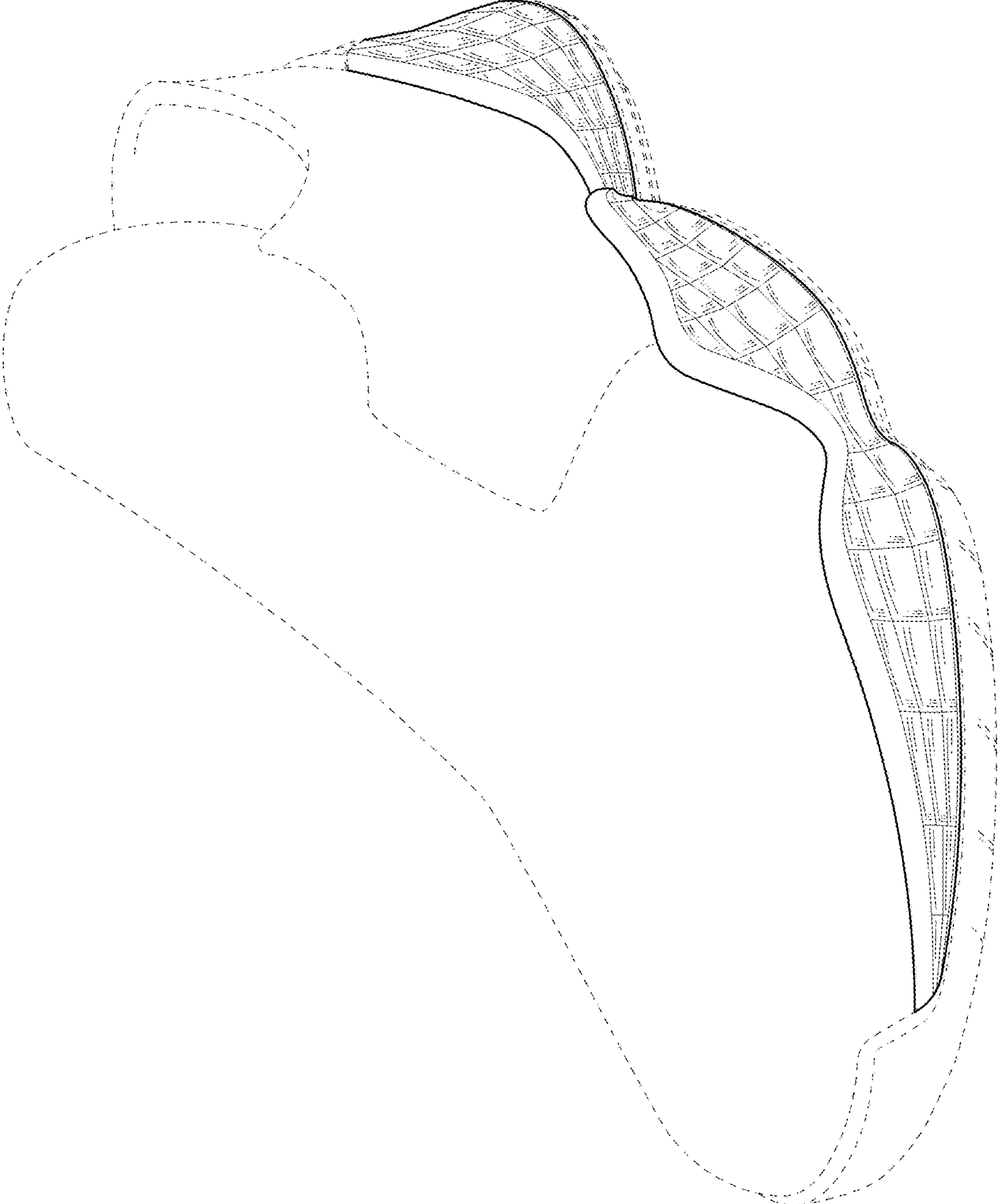

FIG. 1

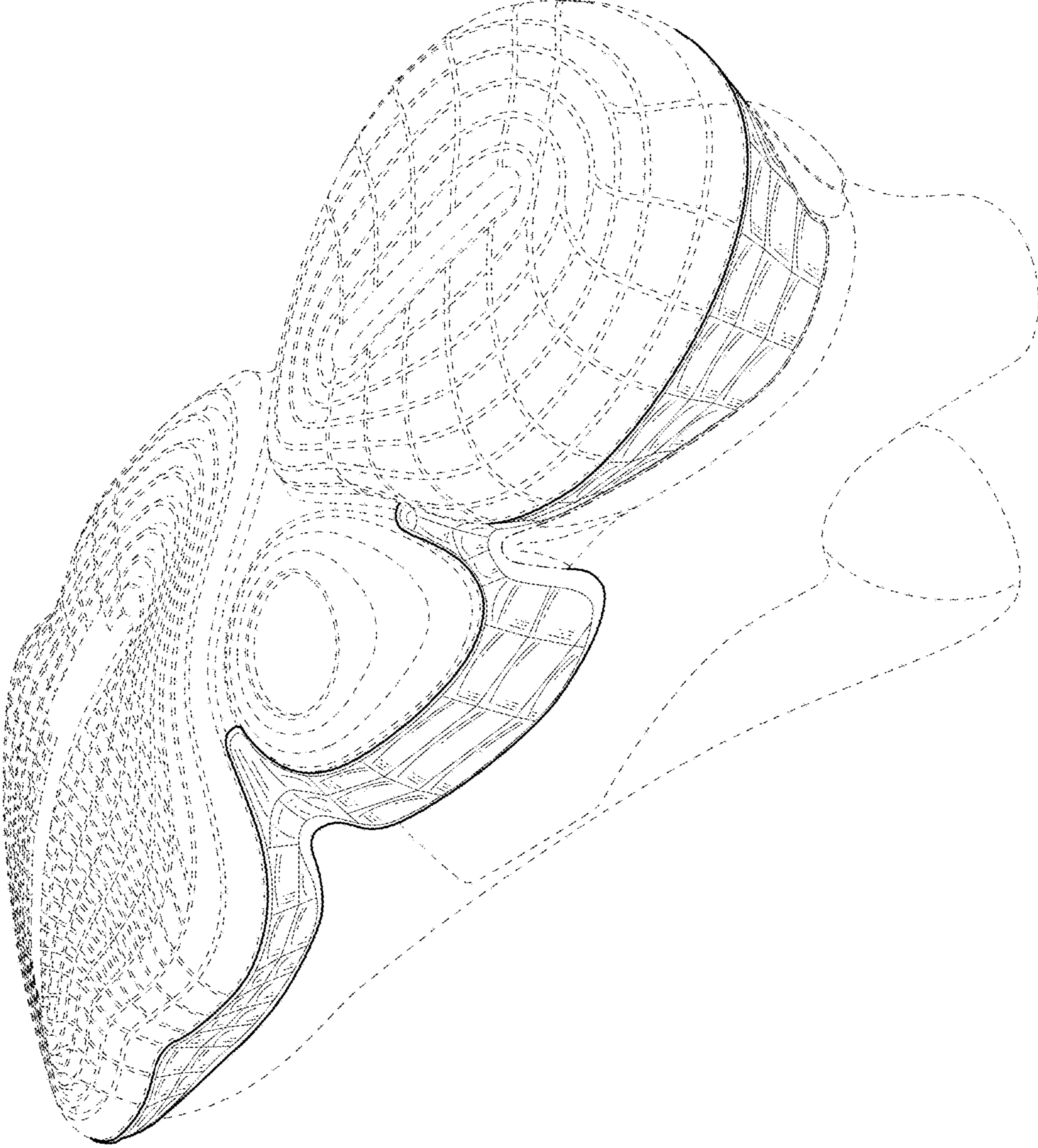

FIG. 2

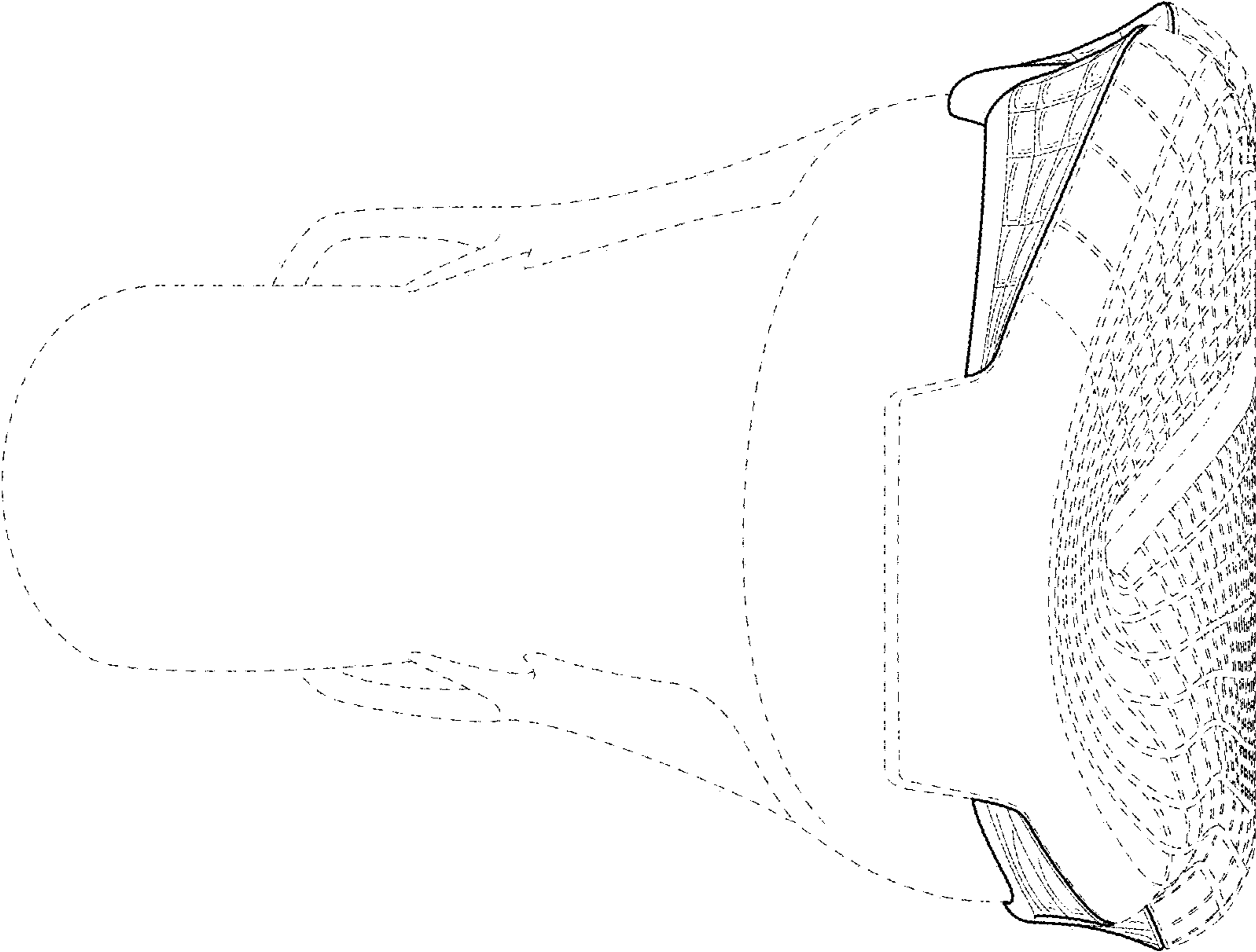

FIG. 3

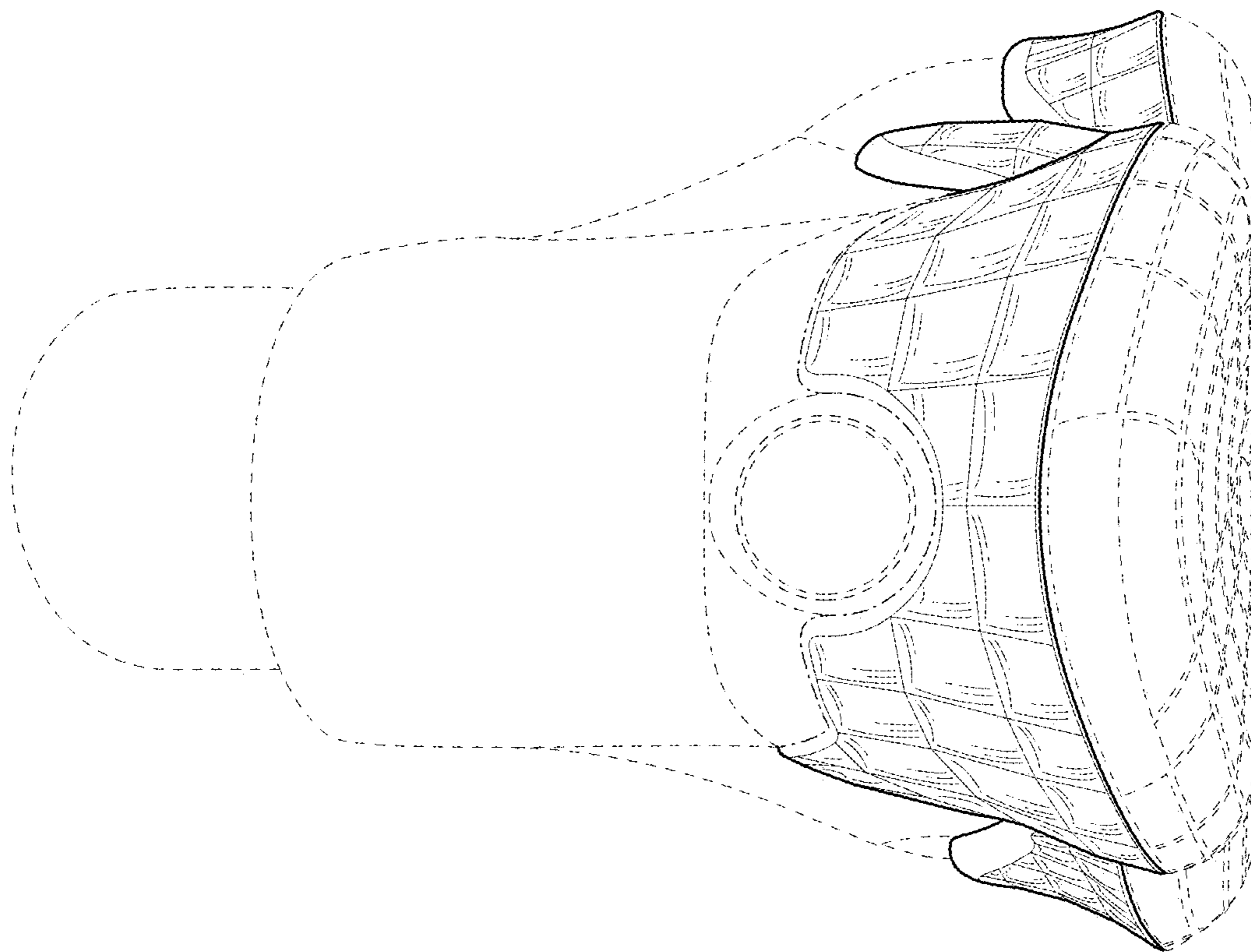

FIG. 4

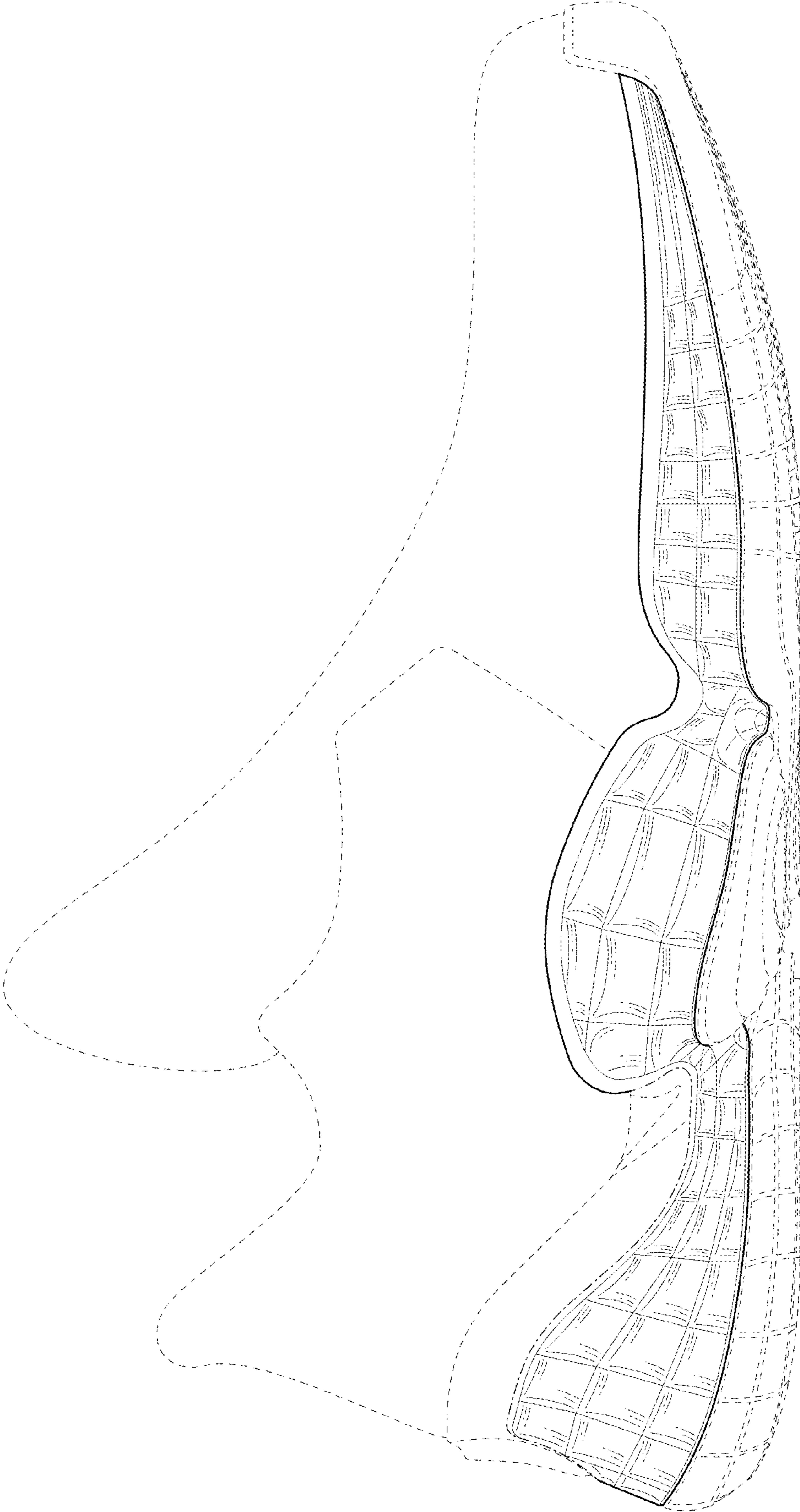

FIG. 5

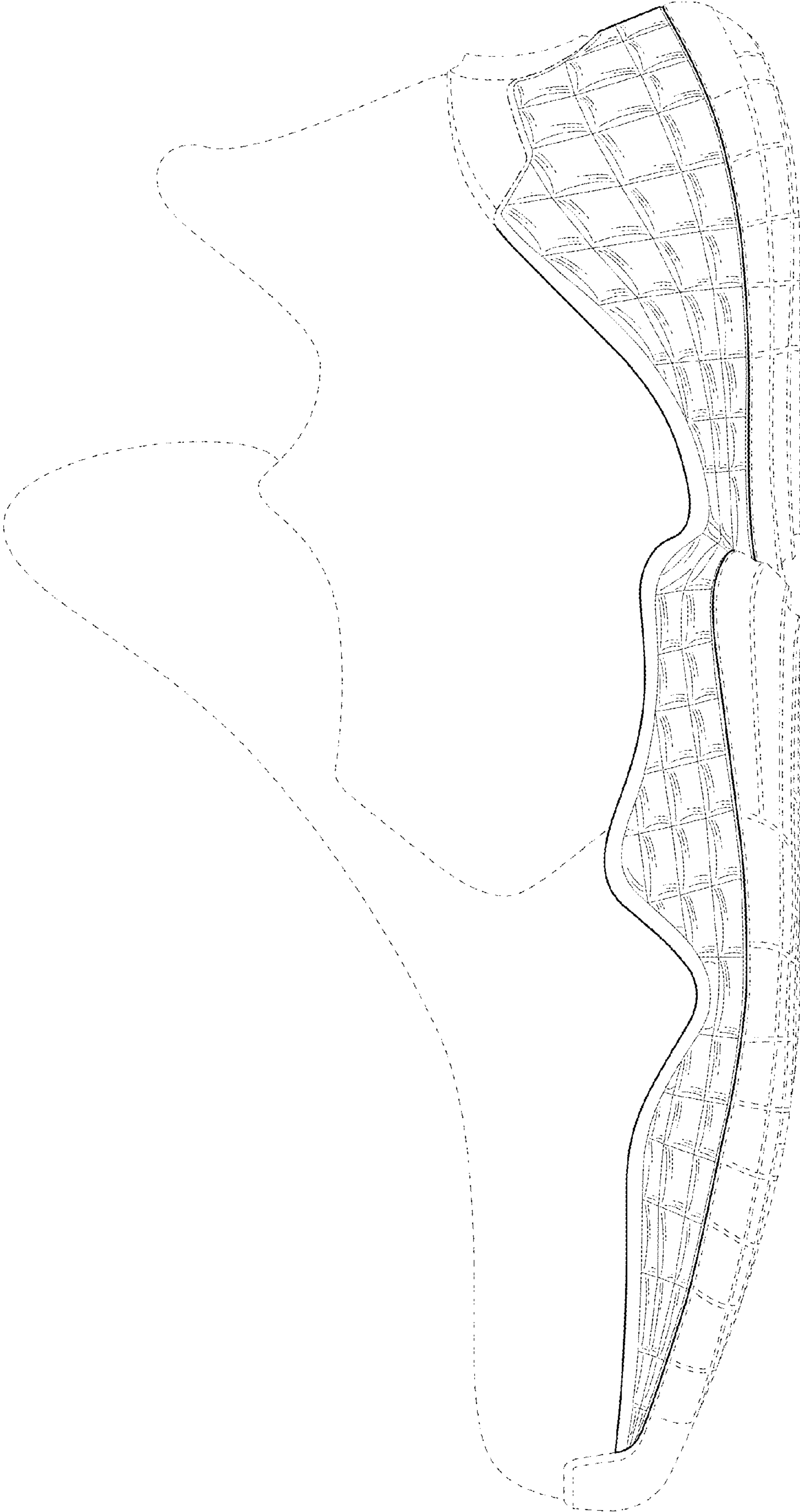

FIG. 6

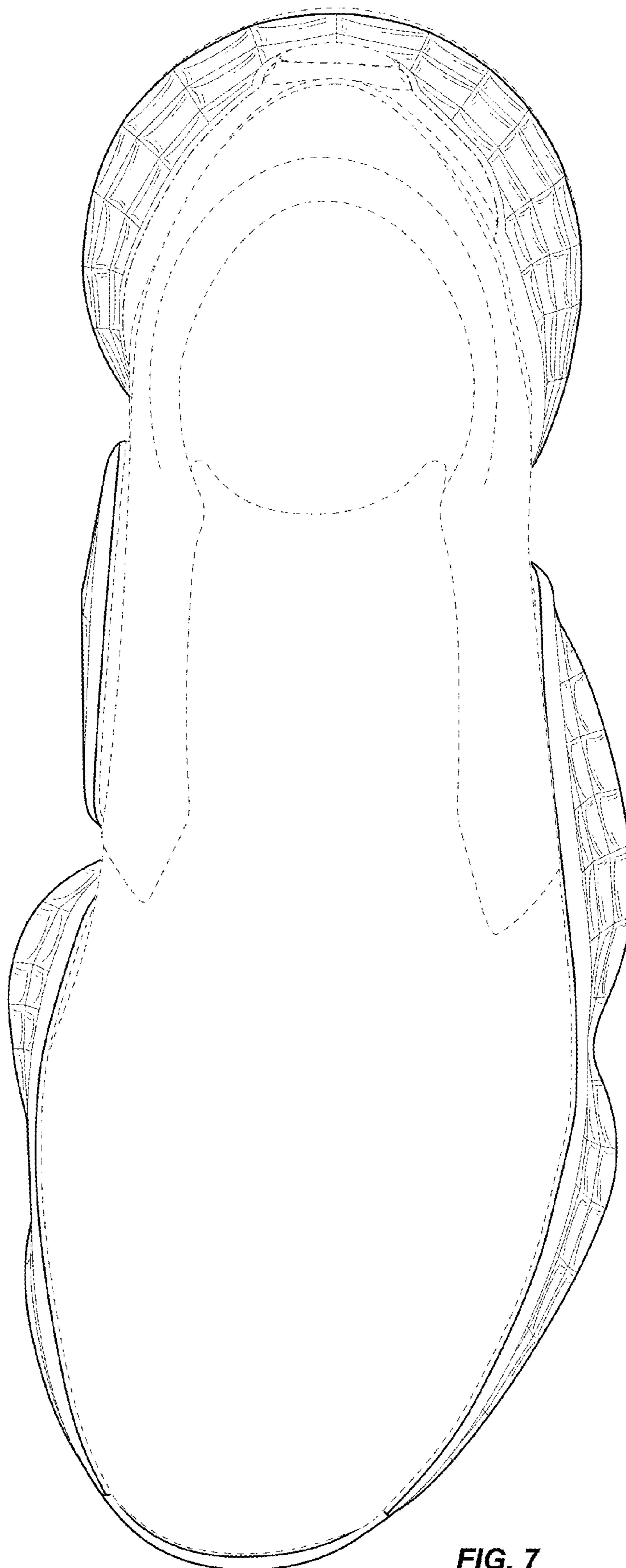

FIG. 7

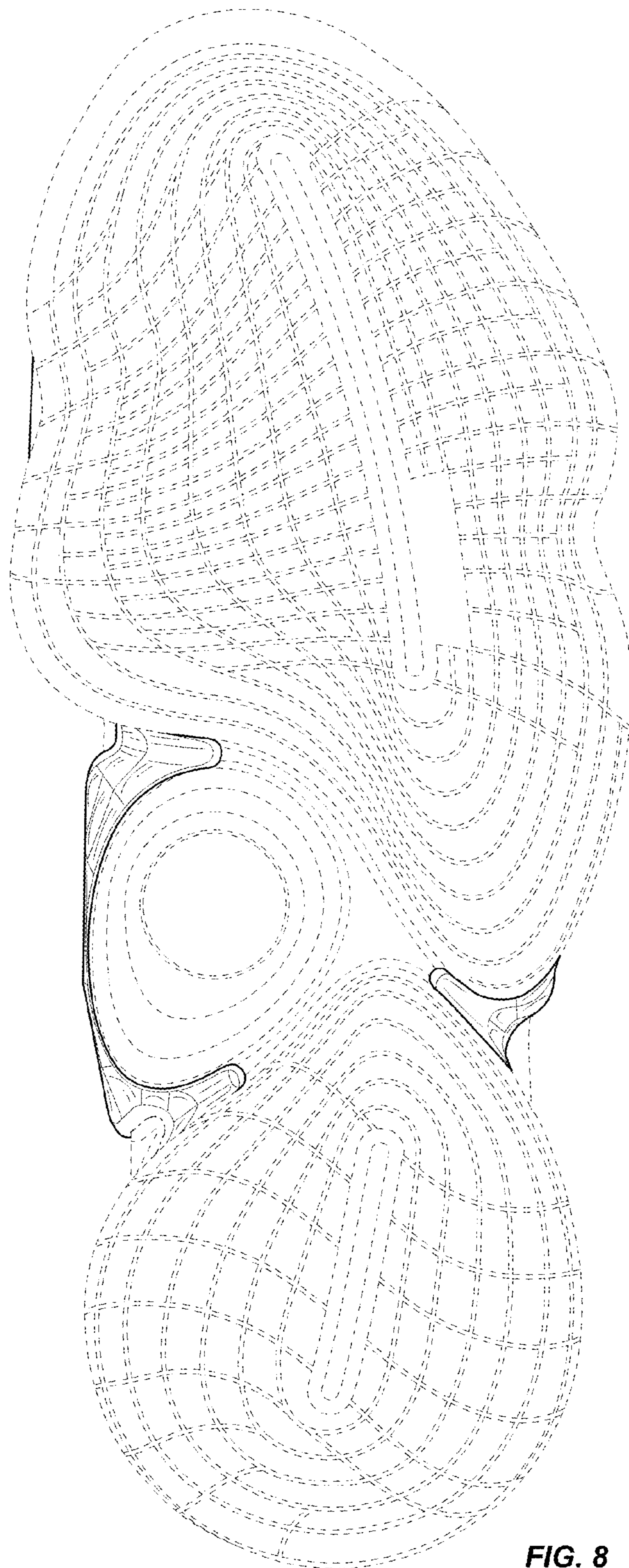

FIG. 8