



US00D889081S

(12) **United States Design Patent** (10) **Patent No.:** **US D889,081 S**  
**Gavrieli et al.** (45) **Date of Patent:** **\*\* Jul. 7, 2020**

(54) **SINGLE-SOLE SHOE WITH GREEN SOLE** 1,208,209 A 12/1916 Prince  
 1,214,666 A 2/1917 Ford  
 (71) Applicant: **Gavrieli Brands LLC**, Beverly Hills, CA (US) 1,519,009 A 12/1924 Reina  
 1,525,848 A \* 2/1925 Bonaventure ..... A43B 5/12  
 36/8.3  
 (72) Inventors: **Kfir Gavrieli**, Los Angeles, CA (US); 1,587,377 A 6/1926 Grosjean  
**Dikla Gavrieli**, Los Angeles, CA (US) 1,650,466 A 11/1927 Righter  
 2,224,590 A 12/1940 Boivin  
 2,268,777 A 1/1942 Scholl  
 (73) Assignee: **Gavrieli Brands LLC**, Beverly Hills, CA (US) D133,819 S \* 9/1942 Harris ..... D2/939  
 D133,791 S 6/1943 Beebe  
 2,323,563 A 7/1943 Nugent  
 2,342,882 A 2/1944 Meltzer  
 (\*) Notice: This patent is subject to a terminal disclaimer. D141,871 S 7/1945 Braun  
 2,383,585 A 8/1945 Bindner  
 D149,685 S \* 5/1948 Sandler ..... D2/935  
 (\*\*) Term: **15 Years** D150,729 S \* 8/1948 Sandler ..... D2/923  
 D166,090 S \* 3/1952 Maling ..... A43B 13/14  
 D2/897

(21) Appl. No.: **29/655,965** 2,772,488 A 12/1956 Meltzer  
 2,904,814 A 9/1959 Scholl  
 (22) Filed: **Jul. 9, 2018** 3,148,378 A 9/1964 Tibbitts  
 D200,897 S \* 4/1965 Gentry ..... D2/919  
 D220,464 S 4/1971 Hayoshi  
 D247,396 S \* 3/1978 Schlerth ..... D2/939

**Related U.S. Application Data**

(63) Continuation of application No. 29/570,765, filed on Jul. 12, 2016, now Pat. No. Des. 825,155, which is a continuation of application No. 29/493,542, filed on Jun. 10, 2014, now Pat. No. Des. 761,536. 4,412,393 A 11/1983 Terlizzi, Jr. et al.  
 D275,525 S 9/1984 Nakao  
 4,674,206 A 6/1987 Lyden  
 D295,692 S \* 5/1988 Zuidema ..... D2/950  
 D300,085 S 3/1989 Ito et al.  
 (51) **LOC (12) Cl.** ..... **02-04** RE33,018 E 8/1989 Ostrander  
 (52) **U.S. Cl.** 4,899,412 A 2/1990 Ganon  
 USPC ..... **D2/939** D316,773 S 5/1991 Valle  
 5,012,541 A 5/1991 Ganon  
 (58) **Field of Classification Search** D339,669 S \* 9/1993 Miller ..... D2/939  
 USPC ..... D2/896, 900, 919-921, 925, 939, 947, 5,282,326 A 2/1994 Schroer, Jr. et al.  
 D2/950, 969, 971; 36/1, 83, 8.1-8.3, 9 R, 5,421,050 A 6/1995 Laganas  
 36/45-58, 104, 108, 76 R 5,699,629 A 12/1997 Munschy  
 5,746,014 A 5/1998 Tanemoto  
 CPC ..... A43B 21/00; A43B 21/02; A43B 21/06; D420,785 S 2/2000 Perez  
 A43B 9/14; A43B 1/0045; A43B 13/10; 6,055,745 A 5/2000 Endoh  
 A43B 13/12; A43B 23/06; A43B 23/07; 6,076,284 A 6/2000 Terlizzi  
 A43B 1/0036; A43B 5/12 6,189,239 B1 2/2001 Gasparovic et al.  
 See application file for complete search history. 6,338,207 B1 1/2002 Chang  
 D457,292 S \* 5/2002 Sessa ..... D2/949  
 D461,947 S 8/2002 Merceron  
 6,588,124 B2 6/2003 Morrone  
 D476,798 S 7/2003 Reynolds et al.  
 D498,041 S 11/2004 McClaskie  
 D500,191 S \* 12/2004 Belley ..... D2/969  
 D501,706 S 2/2005 McClaskie  
 6,857,203 B2 2/2005 Minden  
 6,895,693 B2 5/2005 Baruck

(56) **References Cited**

**U.S. PATENT DOCUMENTS**

249,086 A 11/1881 Pienovi  
 773,850 A 11/1904 Cooper et al.  
 830,941 A 9/1906 Walden

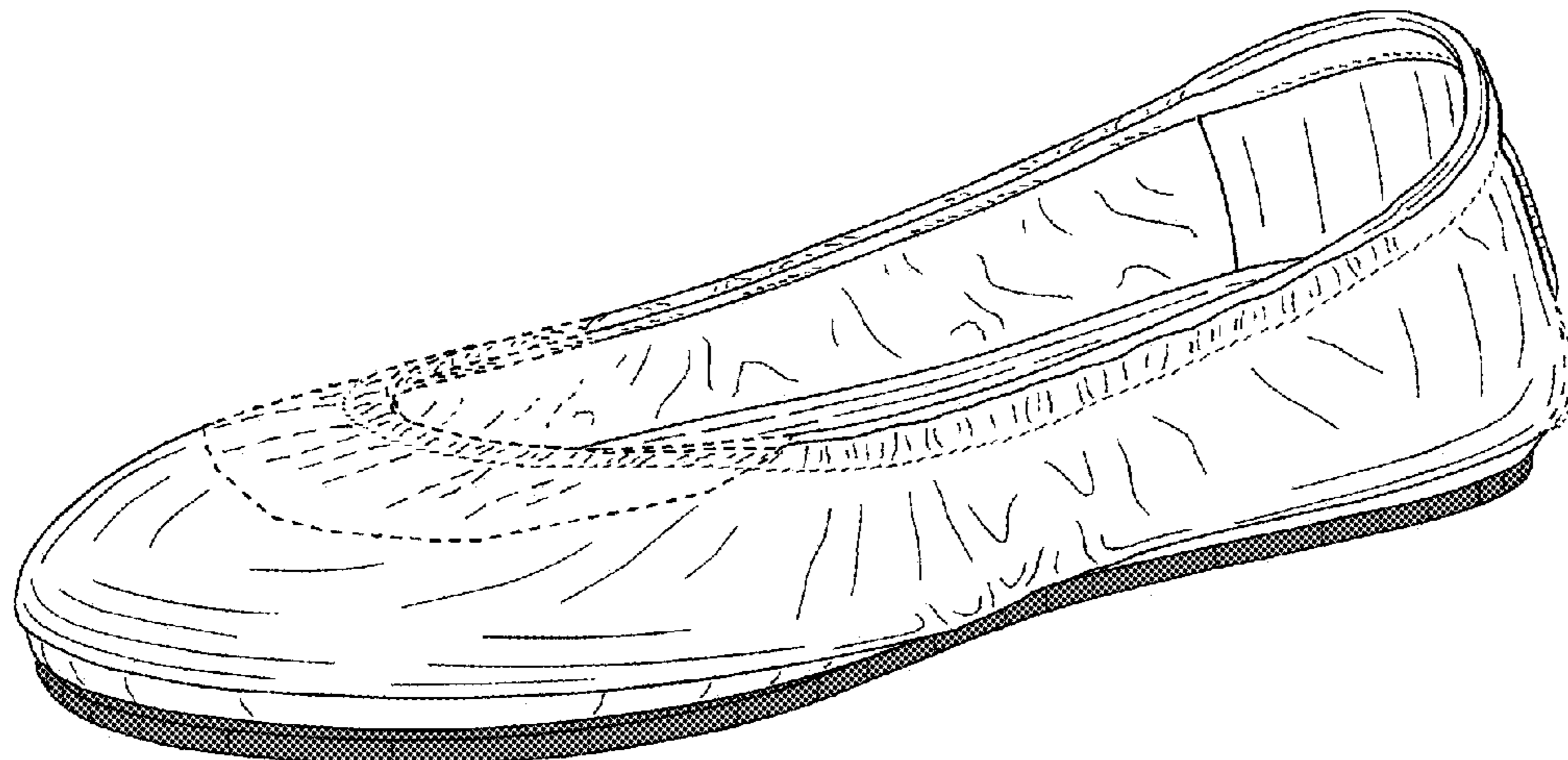

# US D889,081 S

Page 2

6,978,557 B2	12/2005	Lee		D688,854 S *	9/2013	Gavrieli .....	A43B 13/186
7,032,327 B1	4/2006	Tartaglia et al.					D2/939
7,036,244 B1	5/2006	Finch		D688,855 S *	9/2013	Gavrieli .....	A43B 13/16
D527,513 S	9/2006	Della Valle					D2/939
D529,513 S	10/2006	Aketa		D689,270 S *	9/2013	Gavrieli .....	A43B 13/14
D531,790 S	11/2006	Wurzburg					D2/939
D534,341 S *	1/2007	Choi .....	D2/896	D689,271 S *	9/2013	Gavrieli .....	A43B 3/12
D542,513 S	5/2007	Amado et al.					D2/939
D556,990 S	12/2007	Cabados		D689,272 S *	9/2013	Gavrieli .....	A43B 3/108
7,337,558 B2	3/2008	Terlizzi et al.					D2/939
D567,485 S	4/2008	James		D690,914 S *	10/2013	Gavrieli .....	A43B 13/186
D570,488 S	6/2008	Kirksey et al.					D2/939
D571,084 S	6/2008	Comeau		D690,915 S *	10/2013	Gavrieli .....	A43B 3/10
D571,548 S	6/2008	Seamans					D2/939
D571,989 S	7/2008	Siegal					
D580,640 S	11/2008	Wurzburg		D696,500 S	12/2013	Hunt	
D582,638 S	12/2008	Ringholz		D699,424 S	2/2014	Hamm	
7,496,982 B2	3/2009	Clark et al.		8,661,714 B2	3/2014	Sussman	
7,506,459 B2	3/2009	Grisoni et al.		8,745,893 B2	6/2014	Gavrieli et al.	
D591,031 S	4/2009	Cofinco		8,973,287 B2	3/2015	Shibata	
D593,295 S *	6/2009	Belley .....	A43B 3/12	2002/0078591 A1	6/2002	Morrone	
			D2/969	2002/0129519 A1	9/2002	Cahan	
D593,297 S *	6/2009	Belley .....	A43B 13/16	2003/0070319 A1	4/2003	Minden	
			D2/969	2003/0121176 A1	7/2003	Baruck	
D593,307 S *	6/2009	Belley .....	A43B 13/186	2004/0025377 A1	2/2004	Brannon	
			D2/969	2005/0022421 A1	2/2005	Bruckner	
D599,093 S *	9/2009	Issler .....	A43B 13/14	2005/0115115 A1	6/2005	Lacey	
			D2/925	2005/0217148 A1	10/2005	Connolly et al.	
D604,030 S	11/2009	Wilson		2005/0262734 A1	12/2005	Cheng	
D607,194 S	1/2010	Zagula		2006/0086005 A1	4/2006	Yerian	
D610,332 S	2/2010	Raichle		2006/0156576 A1	7/2006	Sloan	
D610,785 S	3/2010	Smith		2007/0074424 A1	4/2007	Lin	
D612,140 S	3/2010	Moon		2007/0204482 A1	9/2007	Gibson-Collinson	
D612,141 S	3/2010	Moon		2007/0204483 A1	9/2007	Kirsch et al.	
7,694,435 B1	4/2010	Kiser et al.		2008/0052964 A1	3/2008	Taylor	
D615,737 S	5/2010	Feller		2008/0086912 A1	4/2008	Wilkenfeld	
7,735,244 B1	6/2010	Ameche		2008/0110059 A1	5/2008	Kuramoto et al.	
7,743,530 B2	6/2010	Truelson		2009/0019732 A1	1/2009	Sussmann	
D618,891 S	7/2010	McClaskie		2009/0193685 A1	8/2009	Wilson	
7,757,408 B2	7/2010	McClaskie		2009/0205222 A1	8/2009	Mclinden	
D630,829 S	1/2011	Weisner		2009/0272009 A1	11/2009	Weisner et al.	
D632,881 S	2/2011	Rosenberg		2010/0011625 A1	1/2010	Percival	
7,926,203 B2	4/2011	Wilkenfeld		2010/0018080 A1	1/2010	Smith	
7,966,747 B2	6/2011	Wilkenfeld et al.		2010/0050469 A1	3/2010	Chen	
D640,861 S	7/2011	Wilkenfeld		2010/0095557 A1	4/2010	Jarvis	
8,020,320 B2	9/2011	Gillespie		2010/0115793 A1	5/2010	Kraisosky	
8,127,468 B2	3/2012	Morgan		2010/0122475 A1	5/2010	Purrington	
D657,543 S	4/2012	Bove		2010/0146822 A1	6/2010	MacGregor	
D659,960 S	5/2012	Bizzo		2010/0212186 A1	8/2010	Cheng	
8,230,619 B2	7/2012	Salvatelli		2010/0275462 A1	11/2010	Pucci	
D664,755 S	8/2012	Gavrieli et al.		2010/0281713 A1	11/2010	Pantazes	
D665,157 S	8/2012	Wu		2015/0089843 A1	4/2015	Gavrieli	
8,240,067 B2	8/2012	Sussmann					
8,245,420 B2	8/2012	Wilson					
D668,027 S	10/2012	Millieret					
D668,438 S	10/2012	Millieret					
D668,847 S *	10/2012	Gavrieli .....	A43B 3/12				
			D2/925				
D668,848 S *	10/2012	Gavrieli .....	A43B 3/108				
			D2/925				
D668,849 S	10/2012	Pozzi					
D668,850 S	10/2012	Pozzi					
D672,542 S	12/2012	Gray et al.					
D676,634 S *	2/2013	Gavrieli .....	A43B 13/186				
			D2/925				
D681,927 S *	5/2013	Gavrieli .....	A43B 13/16				
			D2/939				
D681,928 S *	5/2013	Gavrieli .....	A43B 13/14				
			D2/939				
D681,929 S *	5/2013	Gavrieli .....	A43B 3/24				
			D2/939				
D683,936 S *	6/2013	Gavrieli .....	A43B 13/14				
			D2/939				
8,468,723 B2	6/2013	Malka-Harari					
D686,812 S	7/2013	Gavrieli et al.					
8,510,975 B2	8/2013	Krikelis					
D688,853 S *	9/2013	Gavrieli .....	A43B 3/12				
			D2/939				

## FOREIGN PATENT DOCUMENTS

DE	20	2006	000230	U1	5/2007
GB			2443937	A	5/2008
GB			2 446 205	A	8/2008
TW			D119165		10/2007

## OTHER PUBLICATIONS

Examination Report for AU 341324, 3 pgs., dated Oct. 24, 2012.  
 Letter from TMI and Associates with Office Action, 2 pgs, dated Sep. 19, 2012 <http://www.payless.com/store/?&TLC=Womens&SLC=WomensNewArrivals&BLC=WomensNewArrivalsNewArrivals&With+Regular&ItemCode=60131&LotNumber=062642&Type=Adult&Popularity=637&Descriptvein>.  
 Taiwanese Office Action for TW 101300726, 10 pgs., dated Sep. 6, 2012.  
 "The Love List, Tieks by Gavrieli—Foldable Ballet Flats," <http://thelovelist-carly.blogspot.com.au/2010/09/tieks-by-gavrieli-foldable-ballet.html>, 2 pgs., Sep. 12, 2010.  
 "Tieks by Gavrieli," <http://tieks.com>, 1 pg., retrieved Mar. 13, 2013 from URL.  
 "Try It Mummy!, Tieks by Gavrieli," <http://tryitmummy.blogspot.com.au/2010/12/tieks-by-gavrieli.html>, 3 pgs., Dec. 9, 2010.

- “Wearability—Real People Style, What came first, the City Flat or the Tieks,” <http://wearability.posterous.com/what-came-first-the-city-flat-or-the-tieks>, 2 pgs., Aug. 29, 2010.
- “The Ballet Flat . . . Reinvented; Ballet Flats . . . with a Bonus; Step Into Tieks; Going Places? Take Tieks,” <http://web.archive.org/web/2010052004346/http://www.tieks.com/>; 4 pgs., May 24, 2010.
- “Tieks—Comfortable designer flats you can fit in your purse and wear all day, every day,” <http://web.archive.org/web/20110731151555/http://tieks.com/>; 6 pgs., Jul. 31, 2011.
- “58th Annual Emmy Awards,” [http://spoonsforksandfashion.blogspot.com/2006\\_08\\_01\\_archive.html](http://spoonsforksandfashion.blogspot.com/2006_08_01_archive.html), depicting Nine West flats, 2 pgs., Aug. 1, 2006.
- Pictures of Nine West flats sold in 2006, 3 pgs.
- “I Love a Good Ballet Flat!,” <http://dressupfiles.com/i-love-a-good-ballet-flat>, depicting Sue London flats, 3 pgs., Sep. 3, 2010.
- Pictures of Sue London flats sold in 2010, 2 pgs.
- “Miss Cathie Reviews: The Yosi Samra Foldable Ballet Flat . . .,” <http://www.misscathie.com/2010/01/miss-cathie-reviews-the-yosi-samra-foldable-ballet-flat/>, depicting Yosi Samra flats, 9 pgs., Jan. 2010.
- Pictures of Yosi Samra flats sold in 2010, 2 pgs.
- “Goodbye two thousand ten,” [http://emmajoyrussell.blogspot.com/2010\\_12\\_01\\_archive.html](http://emmajoyrussell.blogspot.com/2010_12_01_archive.html), depicting Gap flats, 39 pgs., Dec. 1, 2010.
- Pictures of Gap flats available for sale in 2010, 9 pgs.
- “Our newest design of folding flats-Pink,” <https://fitinclouds.wordpress.com/2010/05/16/our-newest-design-of-folding-flats-pink/>, depicting Fit in Clouds flats, 1 pg., May 16, 2010.
- “Fit in Clouds Satin Folding Shoes,” <http://www.goodhousekeeping.com/product-reviews/clothing/best-ballet-flats/fit-in-clouds-satin-foldable-ballet-flats>, depicting Fit in Clouds flats, 2 pg., Aug. 2013.
- Pictures of Fit in Clouds flats available for sale in 2011, 4 pgs.
- “Shoes for Standing,” <https://truthinshoes.wordpress.com/2008/07/>, depicting Sam & Libby flats, 2 pgs., Jul. 31, 2008.
- “Target Designer Collaboration: Announcing Sam & Libby Shoes for Target,” <http://www.therecessionista.com/2012/11/target-designer-collaboration-announcing-sam-libby-shoes-for-target.html>, depicting Sam & Libby flats, 1 pg., Nov. 26, 2012.
- Pictures of Sam & Libby flats available for purchase in 2011, 5 pgs.
- “Save your soles with Citisoles ballet flats,” <http://glamazondiaris.com/2009/07/save-your-soles-with-citisoles-ballet-flats>, depicting Citisoles flats, 3 pgs., Jul. 2009.
- Pictures of Citisoles flats available for purchase in 2009, 3 pgs.
- “#16 Corso Como Delicious Pumps Review and Giveaway!,” <http://www.mommatoldmeblog.com/2011/01/16-corso-como-delicious-pumps-review.html>, depicting Corso Como flats, 8 pgs., Jan. 16, 2011.
- Pictures of Corso Como flats available for sale in 2011, 3 pgs.
- “Jil-sander-navy-lead-ballet-flats-product . . .,” [www.ebay.com](http://www.ebay.com), depicting Jil Sander flats, 4 pgs., Nov. 2013.
- Pictures of Jil Sander flats available for sale in 2011, 3 pgs.
- “Spare Soles: Shoes That Roll-up & Fold-up,” <http://herpackinglist.com/2011/01/spare-soles-shoes/>, depicting Spare Soles flats, 2 pgs., Jan. 2011.
- Pictures of Spare Soles flats available for sale in 2011, 5 pgs.
- Pictures of Roll-Upz by Spare Soles flats available for sale in 2011, 6 pgs.
- “The Cutest Blog, Preppy 50 and Loving Lilly, Ballet Flat Delight,” <http://preppy50andlovinglilly.blogspot.com/2011/02/ballet-flat-delight.html>, depicting Henri Bendel flats, 1 pg., Feb. 19, 2011.
- Pictures of Henri Bendel flats available for sale in 2011, 4 pgs.
- “Mumsnet by parents for parents,” [http://www.mumsnet.com/Talk/style\\_and\\_beauty/a1612000-Anyone-tried-Redfoot-Flatmates-foldable-ballet-pumps](http://www.mumsnet.com/Talk/style_and_beauty/a1612000-Anyone-tried-Redfoot-Flatmates-foldable-ballet-pumps), depicting Redfoot Flatmates flats, 1 pg, Nov. 14, 2012.
- Pictures of Redfoot Flatmates flats available for sale in 2011, 6 pgs.
- “Amazon: Customer Reviews: Bloch London Women’s Lux Ballet Flat,” <http://www.amazon.com/Bloch-London-Womens-Ballet-Flat/product-reviews/B004LWP7YW>, depicting Bloch London flats, 4 pgs., Dec. 11, 2011.
- Pictures of Bloch London flats offered for sale in 2011, 11 pgs.
- “H&m foldable leopard print flat,” <https://8485shops.wordpress.com/2011/06/16/flats-for-7-bucks/shoe1/>, depicting h&m flats, 2 pgs., Jun. 16, 2011.
- Pictures of h&m foldable flats offered for sale in 2011, 4 pgs.
- “Seekyt—Juicy Couture Ballet Flats—Are They Worth the Money?,” <http://seekyt.com/juicy-couture-ballet-flats-are-they-worth-the-money/>, 2 pgs., Jun. 3, 2011.
- Pictures of Juicy Couture flats offered for sale in 2011, 3 pgs.
- “Purse Flats,” <http://purseflats.wordpress.com>, depicting Purse Flats by Erica Wilson, 3 pgs., Jul. 12, 2012.
- Pictures of Purse Flats by Erica Wilson offered for sale in 2011, 6 pgs.
- “Tieks by Gavrieli—Comfortable, designer flats you can fit in your purse and wear all day . . .,” <http://web.archive.org/web/20110202210649/http://www.tieks.com/>, 8 pgs., Feb. 2, 2011.
- “Carolina M. M. Gonzalez > Tieks by Gavrieli,” [http://m2facebook.com/Tieks?v=timeline&filter=2&timecutoff=1406427986&page=17&sectionLoadingID=m\\_timeline\\_loading\\_div\\_1293868799\\_126332800\\_8\\_17&timeend=1293868799&timestart=1262332800&tm=AQDOvghWQPN\\_Nbwm&refid=17](http://m2facebook.com/Tieks?v=timeline&filter=2&timecutoff=1406427986&page=17&sectionLoadingID=m_timeline_loading_div_1293868799_126332800_8_17&timeend=1293868799&timestart=1262332800&tm=AQDOvghWQPN_Nbwm&refid=17), 1 pg. Jan. 26, 2010.
- “The Shoes Oprah Would Wear to Work (if She Had to Walk),” <http://www.inc.com/30under30/christina-desmarais/kfir-gavrieli-and-elram-gavrieli-founders-of-tieks.html>, 2 pgs., Jul. 2, 2012.
- “Tieks by Gavrieli,” [http://m2.facebook.com/Tieks?v=timeline&filter=2&timecutoff=1406427986&page=14&sectionLoadingID=m\\_timeline\\_loading\\_div\\_1293868799\\_1262332800\\_8\\_14&timeend=1293868799&timestart=1262332800&tm=AQDOvghWQPN\\_Nbwm&refid=17](http://m2.facebook.com/Tieks?v=timeline&filter=2&timecutoff=1406427986&page=14&sectionLoadingID=m_timeline_loading_div_1293868799_1262332800_8_14&timeend=1293868799&timestart=1262332800&tm=AQDOvghWQPN_Nbwm&refid=17), 4 pgs., Jan. 26, 2010.
- “Mighty Life List, Sensible Shoes,” <http://mightygirl.com/2010/08/24/sensible-shoes/>, 11 pgs., Aug. 24, 2010.
- “Find! Tieks: Fab & sexy flats for fall,” <http://thefabmom.com/2013/08/29/find-tieks-fab-sexy-flats-for-fall/>, 3 pgs. Aug. 29, 2013.
- “Step into Tieks,” <http://sliceofpink.typepad.com/blog/2010/09/tieks-1.html>, 5 pgs., Sep. 22, 2010.
- “In Need of Flat-Soled Shoes,” <http://www.kellywickham.com/mochamomma/2010/10/4/in-need-of-flat-soled-shoes.html>, 4 pgs., Oct. 3, 2010.
- “Say Hello to the Flat Shoes You Need for Fall . . . All 88 of Them!”, Picture of Adam Tucker Shoe/Slipper, <https://www.facebook.com/search/top/?q=adam%20shoes%20slipper>, last accessed Oct. 28, 2016, dated Oct. 1, 2013, 1 page.
- Picture of Adam Tucker Rainbow Shoes, <https://facebook.com/search/top/?q=adam%20shoes%20rainbow>, last accessed Oct. 28, 2016, dated Aug. 14, 2013, 1 page.
- Third Party Submission Under 37 CFR 1.290 regarding U.S. Appl. No. 15/905,239, filed Feb. 9, 2019, 94 pages.
- Order Granting TRO (D.I. 11), *Gavrieli Brands LLC vs. Soto Massini*, Civil Action No. 1:18-cv-00462, Mar. 28, 2018, 2 pages.
- Defendants’ Opposition to Motion for Temporary Restraining Order, Civil Action No. 1:18-cv-00462-GMS, Apr. 1, 2018, 12 pages.
- Declaration of Thomas Pichler in Opposition to Tro Request, C.A. No. 1:18-cv-00462-GMS, Apr. 1, 2018, 8 pages.
- Exhibit A to Pichler Declaration ISO TRO Opposition (D.I. 13-1), C.A. No. 1:18-cv-00462-GMS, Apr. 1, 2018, 29 pages.
- Order TRO (D.I. 18), C.A. No. 1:18, Apr. 4, 2018, 3 pages.
- Defendant Soto Massini (USA) Corporation’s Answer and Counterclaims to Verified Complaint for Patent Infringement, Trade Dress Infringement, and Unfair Competition, C.A. No. 1:18-cv-00462-GMS, May 1, 2018, 26 pages.
- Defendant Soto Massini (USA) Corporation’s Answer to Amended Complaint and Amended Counterclaims, C.A. No. 1:18-cv-00462-GMS, Jun. 5, 2018, 28 pages.
- Defendant Soto Massini (USA) Corporation’s Answer to Amended Complaint and First Amended Counterclaims, C.A. No. 1:18-cv-00462-GMS, Jul. 12, 2018, 31 pages.
- Exhibit A to SACC (45-1), Case 1:18-cv-00462-GMS, 3 pages.
- Exhibit B to SACC (45-2), Case 1:18-cv-00462-GMS, 5 pages.
- Exhibit C to SACC (45-3), Case 1:18-cv-00462-GMS, 5 pages.
- Exhibit D to SACC (45-4), Case 1:18-cv-00462-GMS, 4 pages.
- Defendant Soto—USA’s Invalidity Contentions, C.A. No. 1:18-cv-00462-MN, 16 pages.
- Redacted Verdict Form (D.I. 144), Case 1:18-cv-00462-GMS, 13 pages.

Judgement (D.I. 149), C.A. No. 18-462-MN, May 13, 2019, 3 pages.

*Gavrieli Brands, LLC, v. Soto Massini (USA) Corp., et al.*, (full) Trial Transcript, C.A. No. 18-462(MN), vol. 1, 733 pages.

Expert Report of Caroline de Baere (Fed. R. CIV. P. 26(a)(2)(B), Case No. 18-cv-00462-MN, Mar. 1, 2019, 33 pages.

Exhibit 23, Infringement Analysis in Light of the Alleged Prior Art, 41 pages.

Expert Report of Lance Rake, (Fed. R. CIV. P. 26(a)(2)(B), Mar. 1, 2019, 27 pages.

U.S. Pat. No. 1,525,848, Feb. 10, 1925, B. S. Bonaventure, 3 pages.

Design U.S. Pat. No. 247,396, Mar. 7, 1978, William A. Schlerth, 2 pages.

Design U.S. Pat. No. D611,693 S, Mar. 16, 2010, Barbara Schwartz, 7 pages.

Camper Book Excerpt—Nina Right, (pp. 334-335), The Walking Society, Lars Müller Publishers, 3 pages.

Camper History—The Shoes, Every Season We Strive to Reinvent Some of Our Classic Concepts While Continuing to Challenge the Status Quo With New and Original Designs. We Often Find That There Is a Camper Style for Every Walk of Life, 8 pages.

Tieks by Gavrieli—Comfortable, designer flats you can fit in your purse and wear all day, every day!, Copperhead Snake Print Tieks, <https://web.archive.org/web/20101230062534/http://www.tieks.com:80/>, Dec. 30, 2010, 1 page.

Tieks by Gavrieli—Comfortable, designer flats you can fit in your purse and wear all day, every day!, Merlot Lizard Print Tieks, <https://web.archive.org/web/20101230062534/http://www.tieks.com:80/>, Dec. 30, 2010, 1 page.

Tieks by Gavrieli—Comfortable, designer flats you can fit in your purse and wear all day, every day!, Slate Grey Tieks, <https://web.archive.org/web/20101230062534/http://www.tieks.com:80/>, Dec. 30, 2010, 1 page.

Tieks by Gavrieli—Comfortable, designer flats you can fit in your purse and wear all day, every day!, Camel, <https://web.archive.org/web/20101230062534/http://www.tieks.com:80/>, Dec. 30, 2010, 1 page.

Tieks by Gavrieli—Comfortable, designer flats you can fit in your purse and wear all day, every day!, Lilac, <https://web.archive.org/web/20101230062534/http://www.tieks.com:80/>, Dec. 30, 2010, 1 page.

Tieks by Gavrieli—Comfortable, designer flats you can fit in your purse and wear all day, every day!, Leopard Print, <https://web.archive.org/web/20101230062534/http://www.tieks.com:80/>, Dec. 30, 2010, 1 page.

Tieks by Gavrieli—Comfortable, designer flats you can fit in your purse and wear all day, every day!, The Tieks eGift card . . . Always the perfect fit, <https://web.archive.org/web/20101230062534/http://www.tieks.com:80/>, Dec. 30, 2010, 1 page.

Tieks by Gavrieli—Comfortable, designer flats you can fit in your purse and wear all day, every day!, Copperhead Snake Print, <https://web.archive.org/web/20110222174850/http://www.tieks.com:80/>, Feb. 22, 2011, 1 page.

Tieks by Gavrieli—Comfortable, designer flats you can fit in your purse and wear all day, every day!, Patent Tiek Blue, <https://web.archive.org/web/20110222174850/http://www.tieks.com:80/>, Feb. 22, 2011, 1 page.

Tieks by Gavrieli—Comfortable, designer flats you can fit in your purse and wear all day, every day!, Tangerine, <https://web.archive.org/web/20110222174850/http://www.tieks.com:80/>, Feb. 22, 2011, 1 page.

Tieks by Gavrieli—Fashionable Flats That Fit in Your Purse California Navy, <https://web.archive.org/web/20100516173039/http://www.tieks.com:80/california-navy.html>, May 16, 2010, 1 page.

Tieks by Gavrieli—Fashionable Flats That Fit in Your Purse Cardinal Red, <https://web.archive.org/web/20100516173045/http://www.tieks.com:80/cardinal-red.html>, May 16, 2010, 1 page.

Tieks by Gavrieli—Fashionable Flats That Fit in Your Purse Metallic Gold, <https://web.archive.org/web/20100516173106/tieks.com/metallic-gold.html>, May 16, 2010, 1 page.

Tieks by Gavrieli—Fashionable Flats That Fit in Your Purse Patent Tiek Blue, <https://web.archive.org/web/20100516173130/http://www.tieks.com:80/tiek-blue.html>, May 16, 2010, 1 page.

Tieks by Gavrieli—Fashionable Flats That Fit in Your Purse Splash Page, The Ballet Flat . . . Reinvented, <https://web.archive.org/web/20100513055818/https://tieks.com/>, May 13, 2010, 1 page.

Tieks by Gavrieli—Fashionable Flats That Fit in Your Purse Splash Page, Ballet Flats . . . with a Bonus, <https://web.archive.org/web/20100513055818/https://tieks.com/>, May 13, 2010, 1 page.

Tieks by Gavrieli—Fashionable Flats That Fit in Your Purse Splash Page, Going Places? Take Tieks. <https://web.archive.org/web/20100513055818/https://tieks.com/>, May 13, 2010, 1 page.

Tieks by Gavrieli—Fashionable Flats That Fit in Your Purse Splash Page, Step Into Tieks, <https://web.archive.org/web/20100513055818/https://tieks.com/>, May 13, 2010, 1 page.

Tieks by Gavrieli—Fashionable Flats That Fit in Your Purse True Blue, <https://web.archive.org/web/20100516173135/http://www.tieks.com:80/true-blue.html>, May 16, 2010, 1 page.

Tieks by Gavrieli—Fashionable Flats That Fit in Your Purse White Croc Print, <https://web.archive.org/web/20100516173145/http://www.tieks.com:80/white-croc-print.html>, May 16, 2010, 1 page.

Tieks by Gavrieli—Foldable Fashionable Ballet Flats, Wild Copper, Be a little wild . . . even when you're not., <https://web.archive.org/web/20100819165503/https://www.tieks.com/>, Aug. 19, 2010, 1 page.

Tieks by Gavrieli—Foldable Fashionable Ballet Flats, Paradise Blue, The perfect pair for day and night, <https://web.archive.org/web/20100819165503/https://tieks.com/>, Aug. 19, 2010, 1 page.

Tieks by Gavrieli—Foldable Fashionable Ballet Flats, Obsidian Black, When workdays spill over into party nights., <https://web.archive.org/web/20100819165503/https://tieks.com/>, Aug. 19, 2010, 1 page.

Tieks by Gavrieli—Foldable Fashionable Ballet Flats, Fuchsia, Sweet and sultry, <https://web.archive.org/web/20100819165503/https://tieks.com/>, Aug. 19, 2010, 1 page.

Tieks by Gavrieli—Foldable Fashionable Ballet Flats, Tan Croc print Tieks, A timeless texture., <https://web.archive.org/web/20100819165503/https://tieks.com/>, Aug. 19, 2010, 1 page.

Tieks by Gavrieli—Foldable Fashionable Ballet Flats, Be a little wild . . . even when you're not., <https://web.archive.org/web/20100902020755/https://tieks.com/>, Sep. 2, 2010, 1 page.

Tieks by Gavrieli—Foldable Fashionable Ballet Flats, Obsidian Black, When workdays spill over into party nights. <https://web.archive.org/web/20100902020755/https://tieks.com/>, Sep. 2, 2010, 1 page.

Tieks by Gavrieli—Foldable Fashionable Ballet Flats, Tan Croc Print, A timeless texture, <https://web.archive.org/web/20100902020755/https://tieks.com/>, Sep. 2, 2010, 1 page.

Tieks by Gavrieli—Foldable Fashionable Ballet Flats, Paradise Blue, The perfect pair for day and night, <https://web.archive.org/web/20100902020755/https://tieks.com/>, Sep. 2, 2010, 1 page.

Tieks by Gavrieli—Foldable Fashionable Ballet Flats, Fuchsia, Sweet and sultry, <https://web.archive.org/web/20100902020755/https://tieks.com/>, Sep. 2, 2010, 1 page.

Tieks by Gavrieli—Foldable Fashionable Ballet Flats, Tiek Blue Tieks, Let yourself shine, <https://web.archive.org/web/20100902020755/https://tieks.com/>, Sep. 2, 2010, 1 page.

\* cited by examiner

*Primary Examiner* — Dominic V Simone

(74) *Attorney, Agent, or Firm* — Morgan, Lewis & Bockius LLP

(57)

#### CLAIM

The ornamental design for a single-sole shoe with green sole, as shown and described.

#### DESCRIPTION

The file of this patent contains at least one drawing executed in color. Copies of this patent with color drawing(s) will be provided by the Office upon request and payment of the necessary fee.

FIG. 1 is a perspective view of a single-sole shoe with green sole shaded to show the color Green, showing our new design;

FIG. 2 is a first side view thereof;

FIG. 3 is a second side view thereof;

FIG. 4 is a top view thereof;

FIG. 5 is a bottom view thereof;

FIG. 6 is a front view thereof;

FIG. 7 is a back view thereof;

FIG. 8 is a perspective view of a second embodiment of our new design of a single-sole shoe with green sole, where the Green portions are indicated using the USPTO convention of solid diagonal lines extending from the upper left to the lower right for Green;

FIG. 9 is a first side view thereof;

FIG. 10 is a second side view thereof;

FIG. 11 is a top view thereof;

FIG. 12 is a bottom view thereof;

FIG. 13 is a front view thereof; and,

FIG. 14 is a back view thereof.

The broken lines illustrating the toe elastic area, the half moon patch, the heel stripe, and the channel on the green sole in the above described Figures are for illustrative purposes only and form no part of the claimed design.

**1 Claim, 12 Drawing Sheets**  
**(5 of 12 Drawing Sheet(s) Filed in Color)**

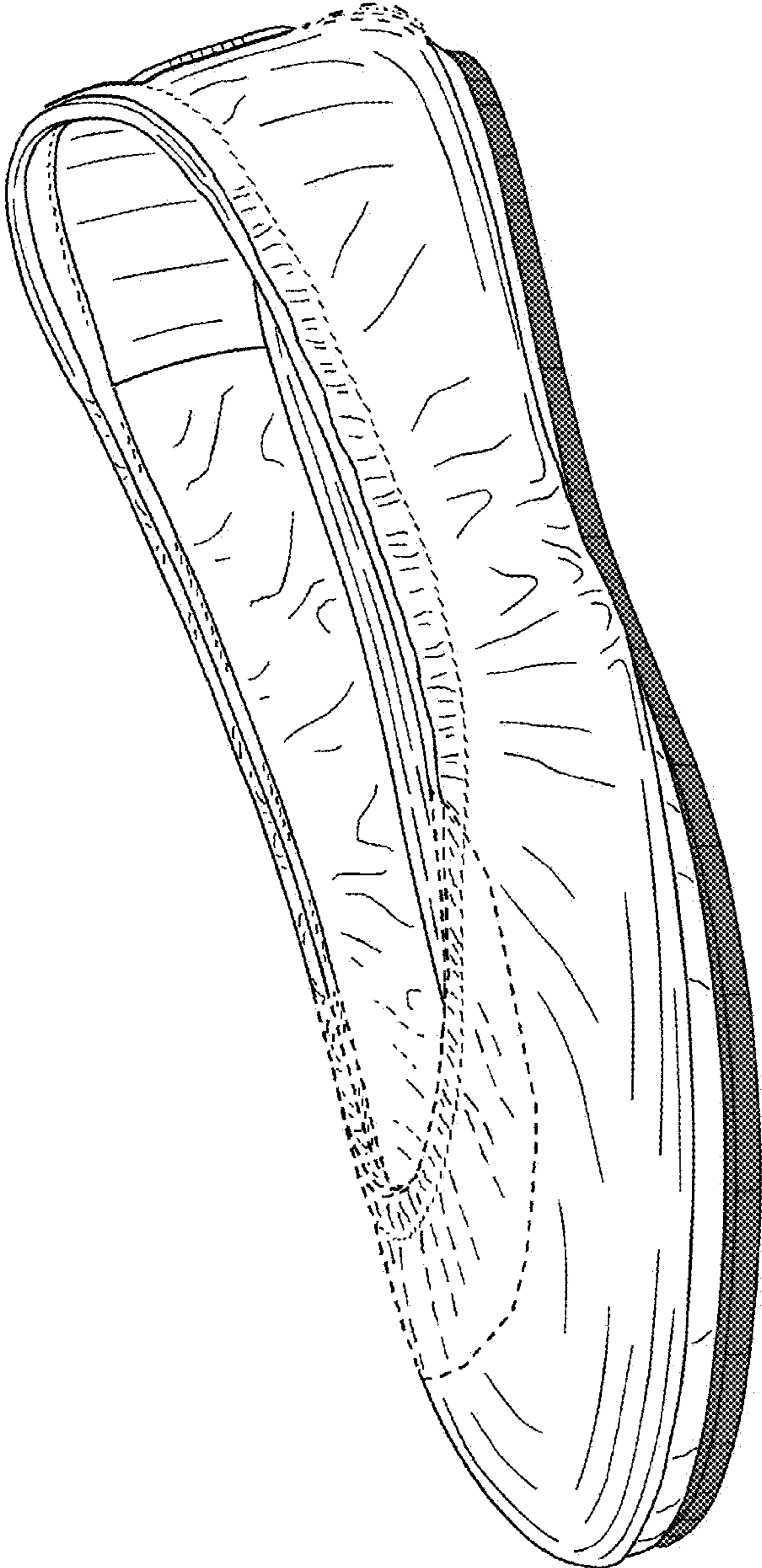

FIG. 1

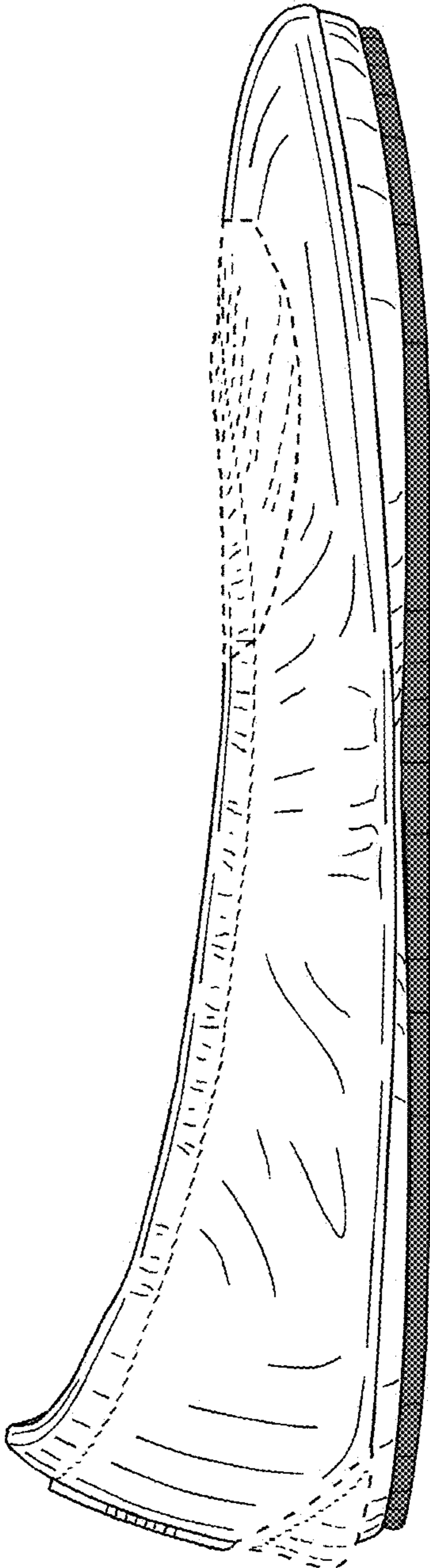

FIG. 2

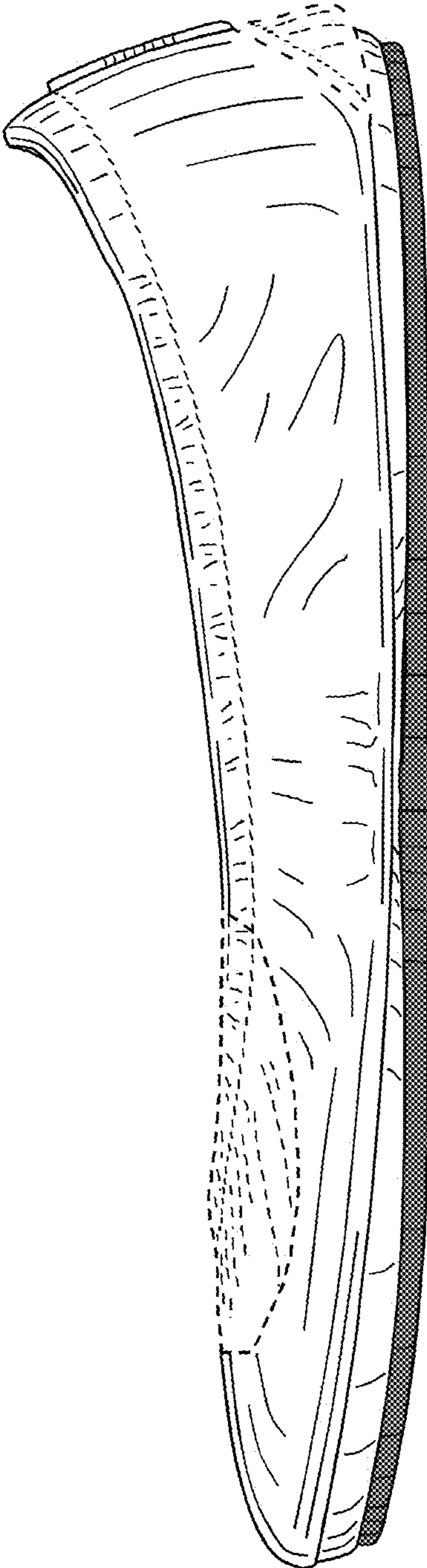

FIG. 3



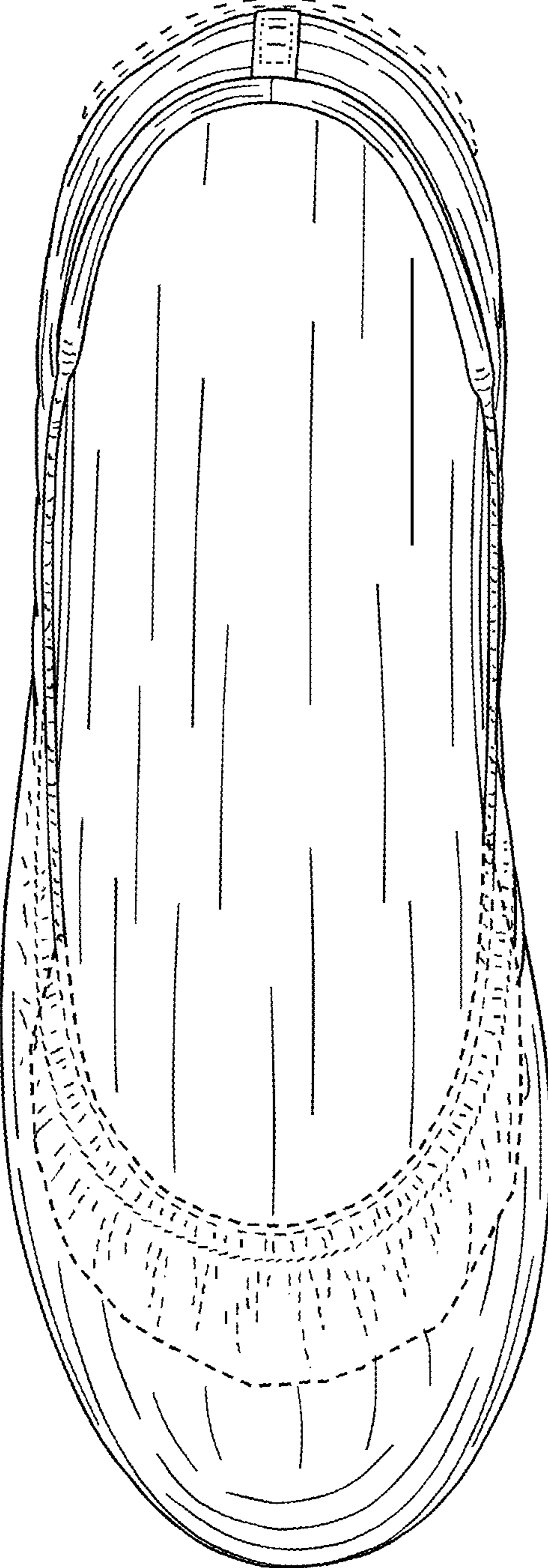

FIG. 4

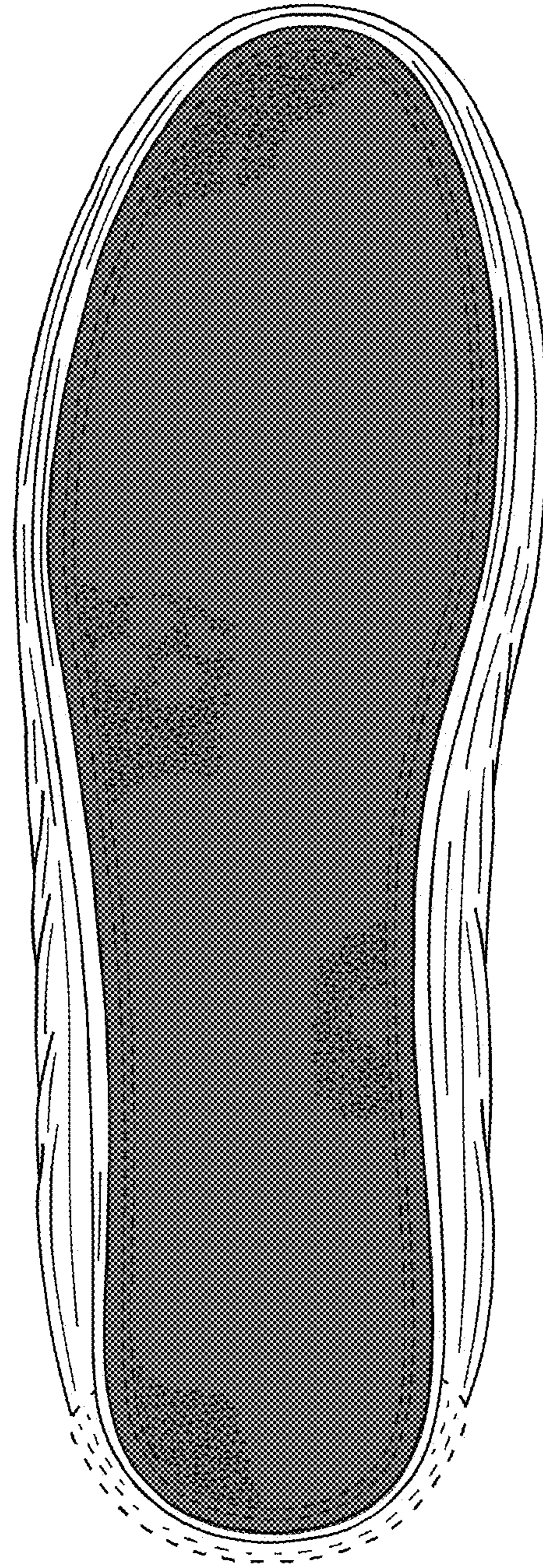

FIG. 5

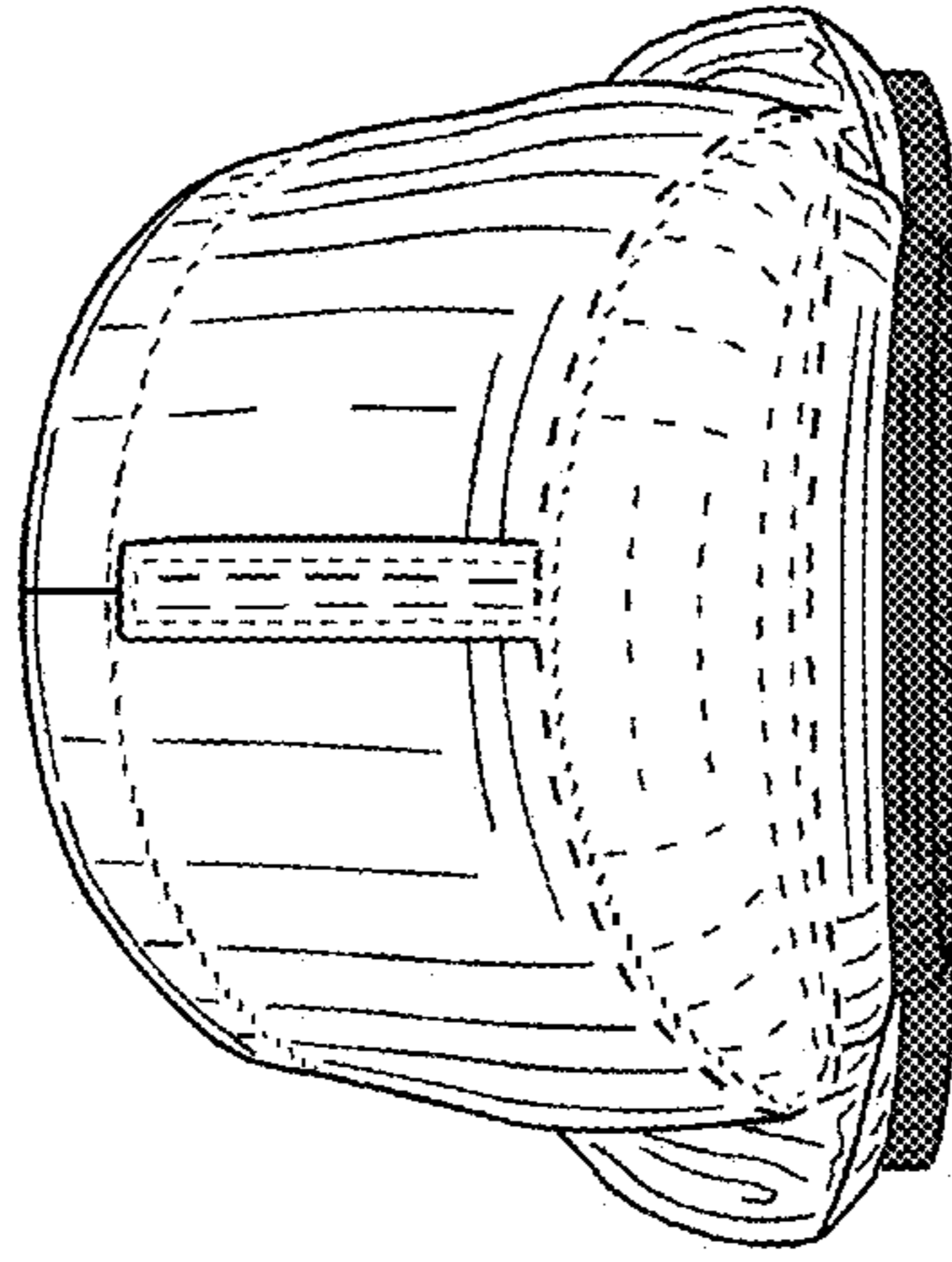

FIG. 7

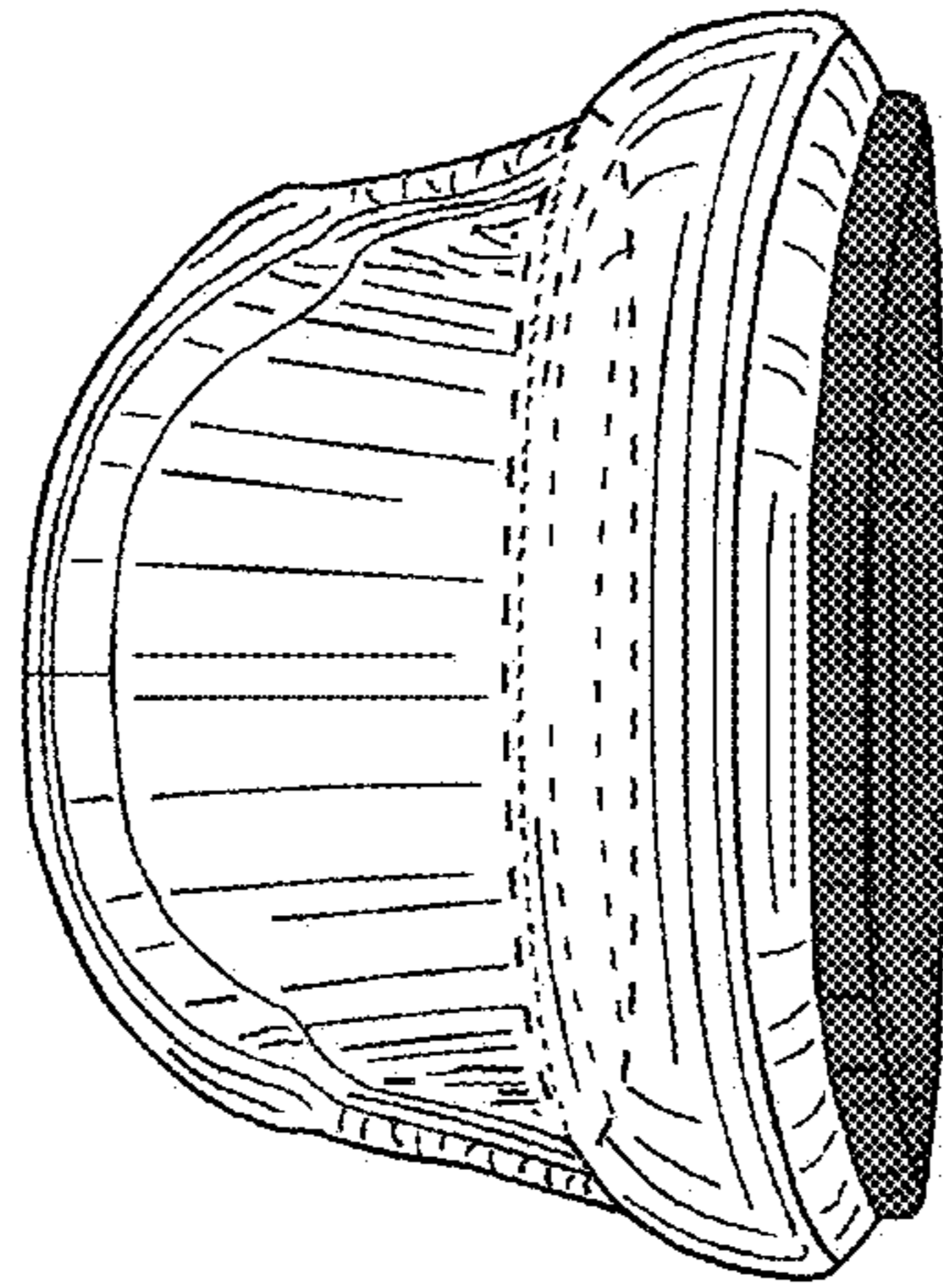

FIG. 6

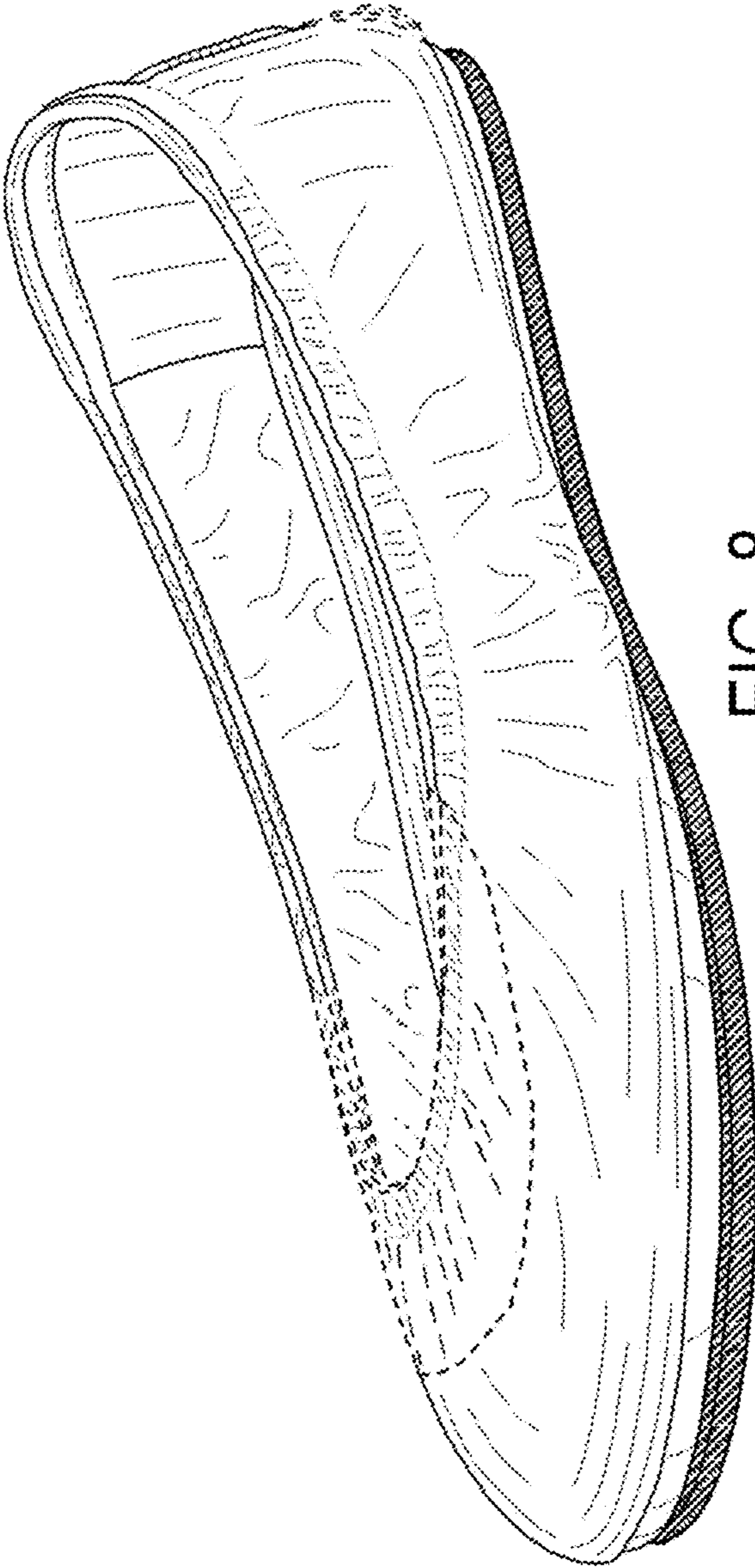

FIG. 8

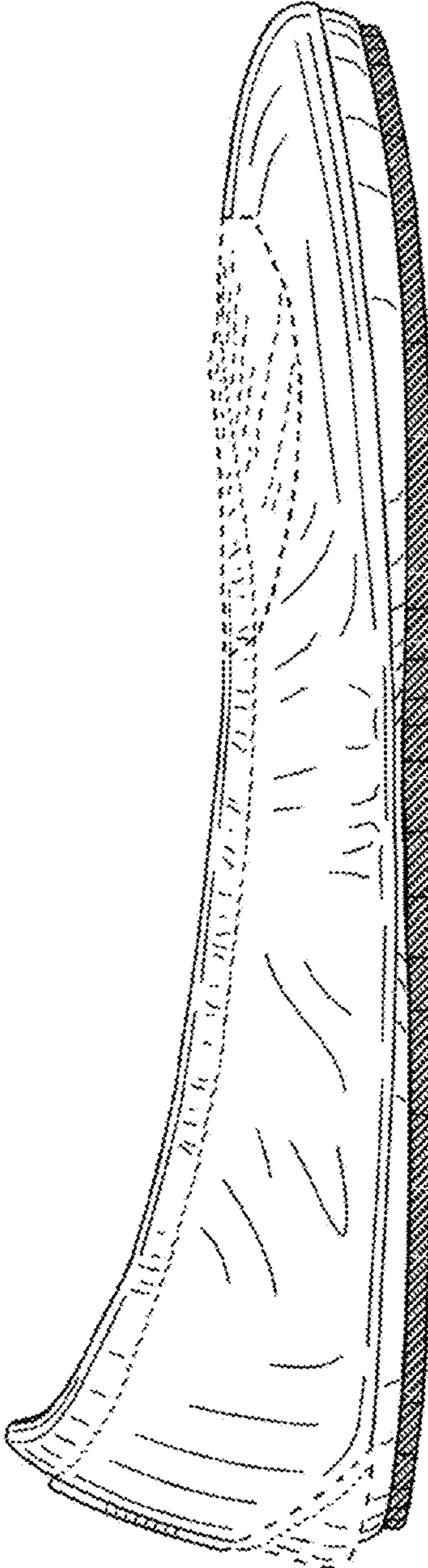

FIG. 9

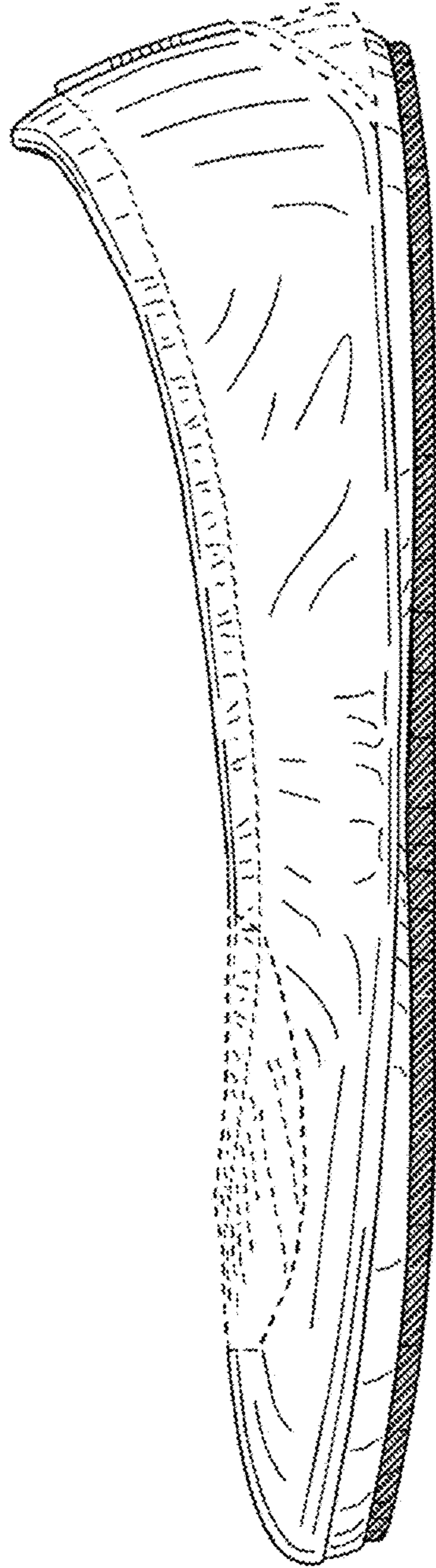

FIG. 10

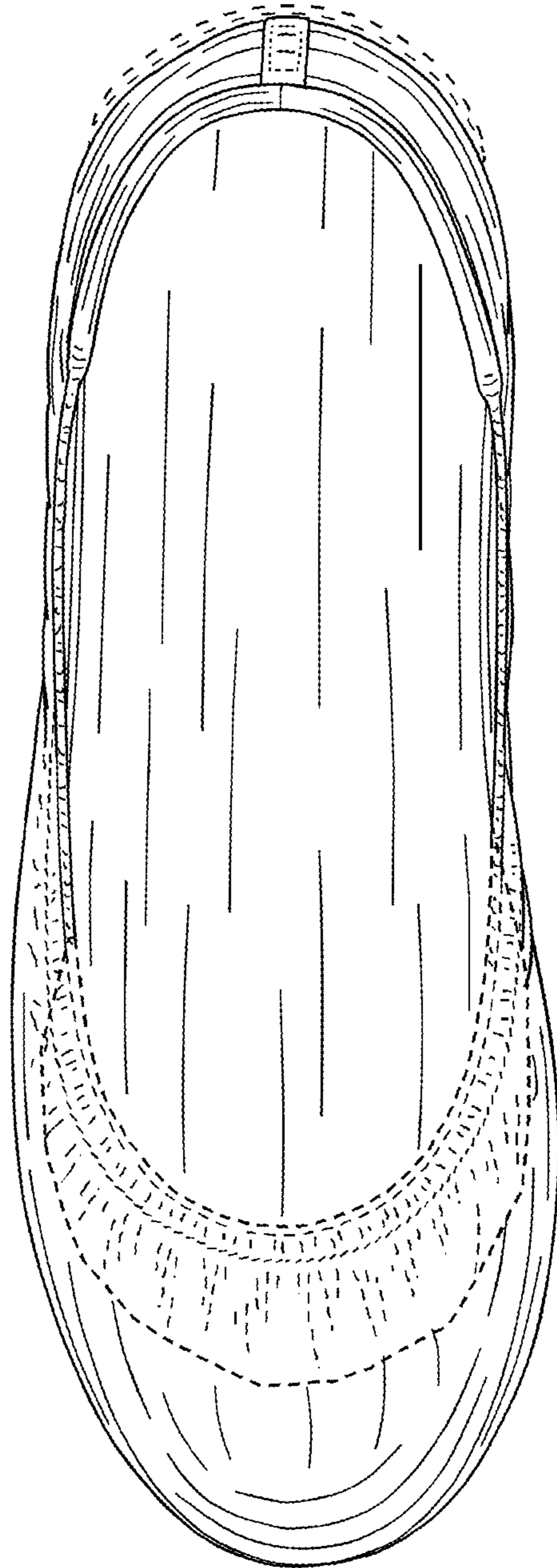

FIG. 11

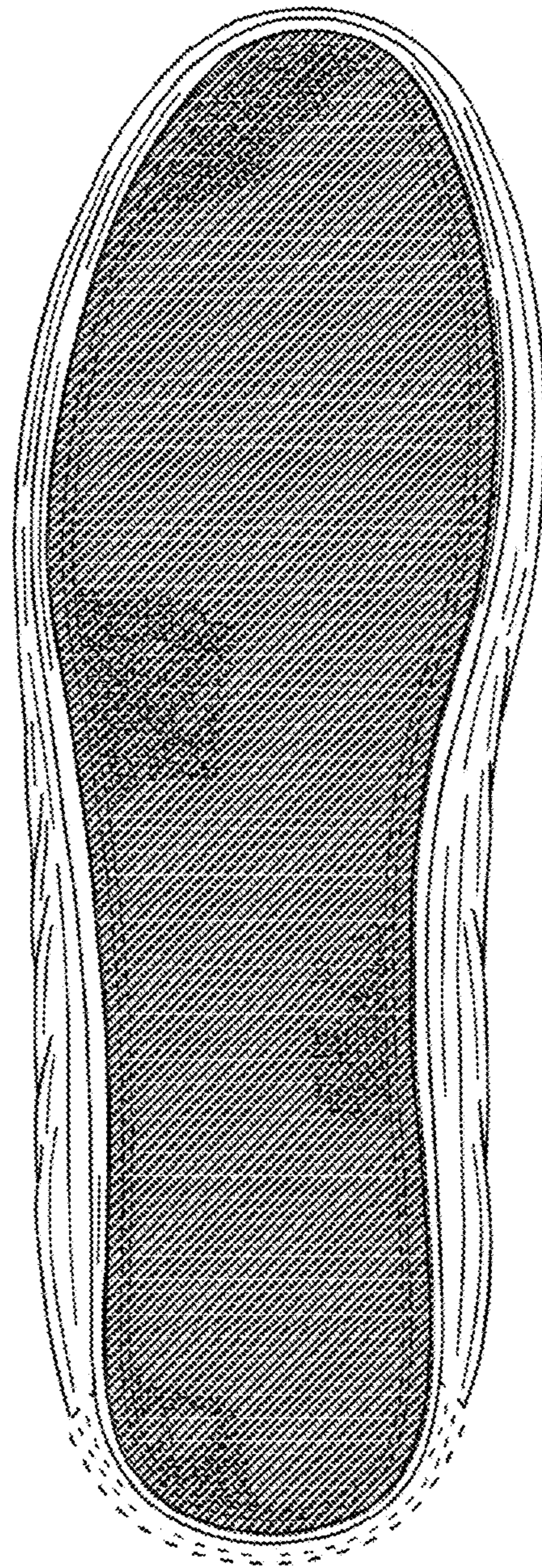

FIG. 12



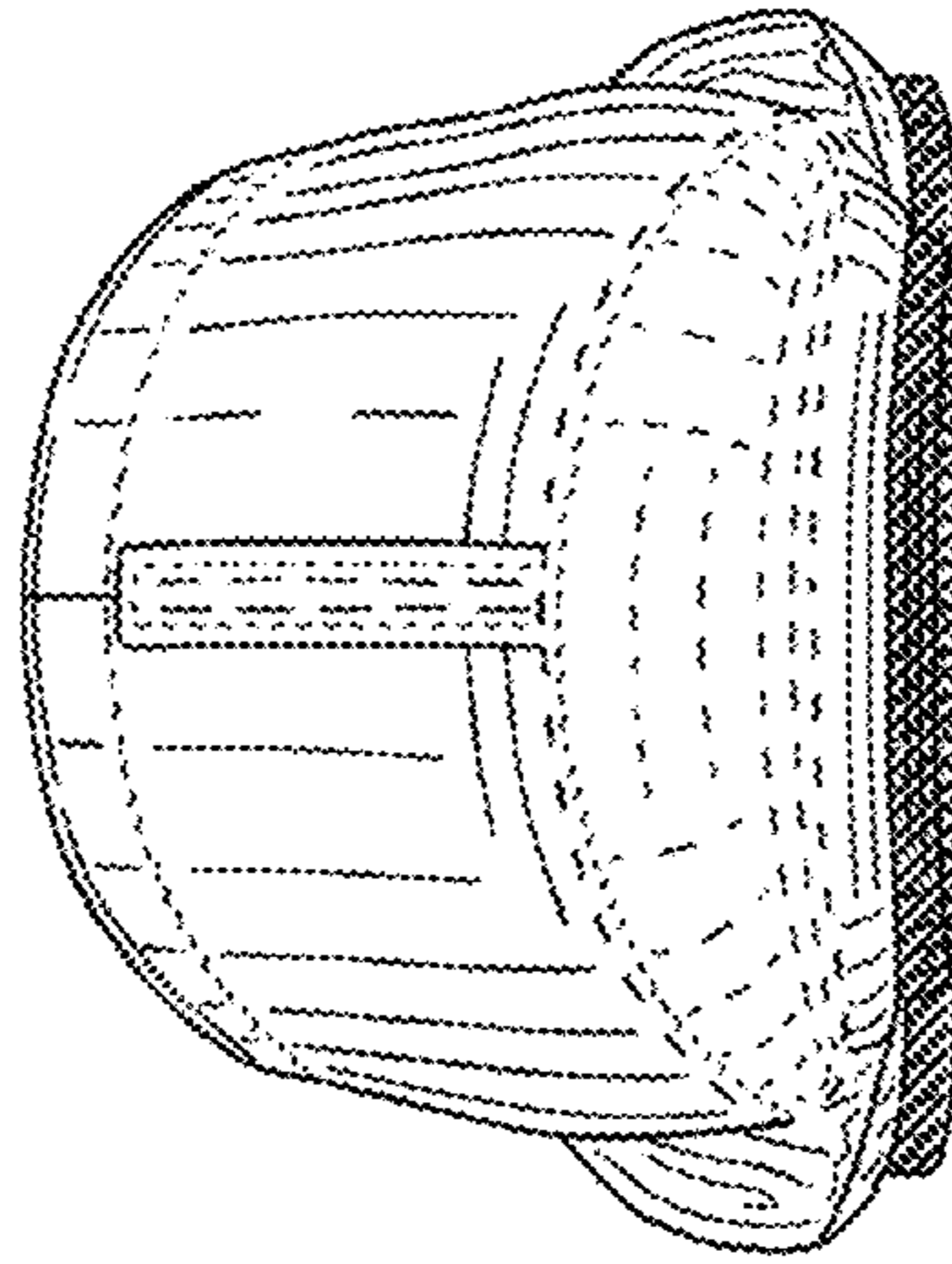

FIG. 14

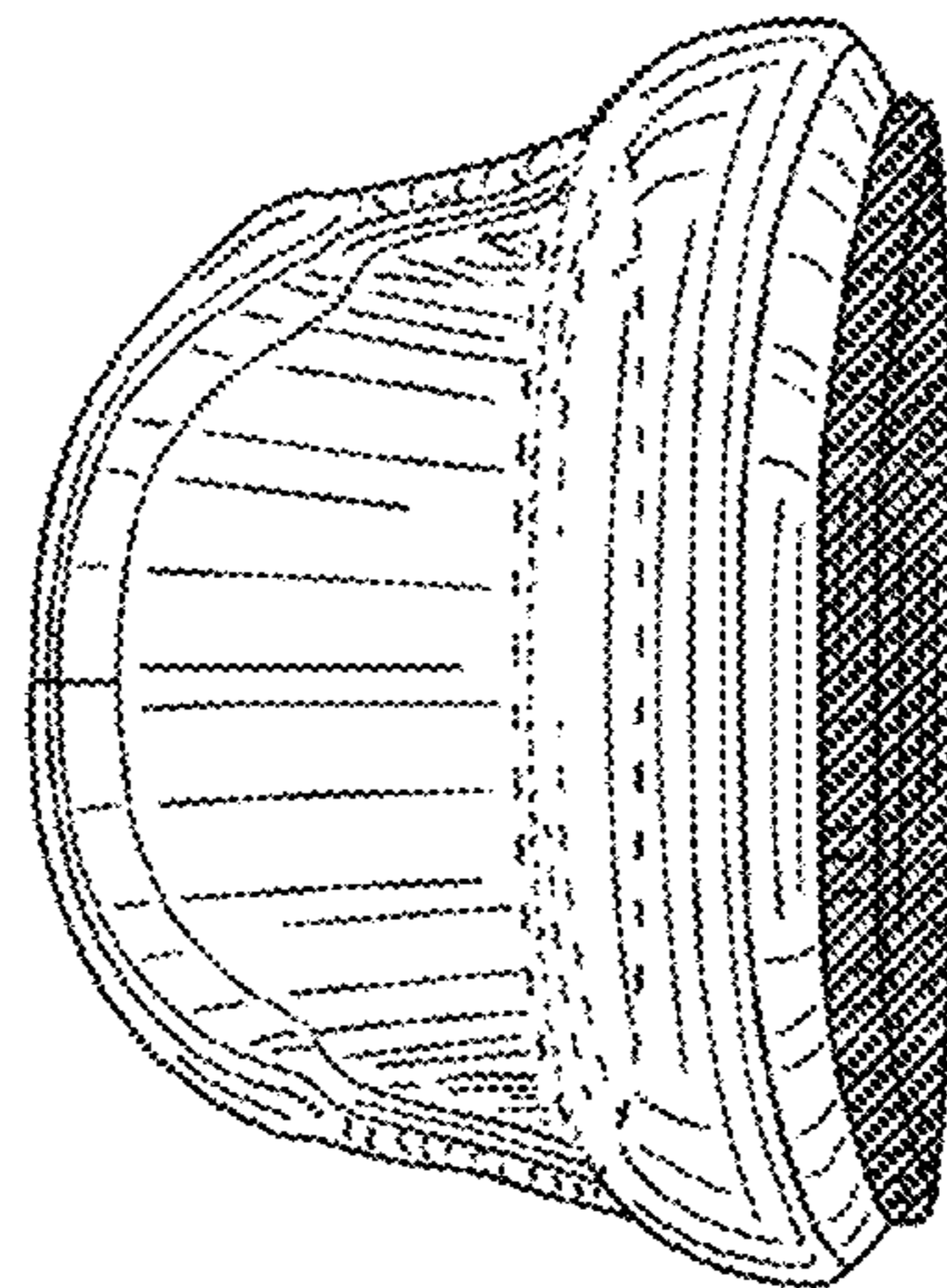

FIG. 13