



US00D889037S

(12) **United States Design Patent**  
**Treb et al.**

(10) **Patent No.:** **US D889,037 S**  
(45) **Date of Patent:** **\*\* Jun. 30, 2020**

- (54) **HAIR EXTENSION STYLING APPARATUS**
- (71) Applicant: **Hair Works LLC**, Walnut Creek, CA (US)
- (72) Inventors: **Susan Treb**, Walnut Creek, CA (US);  
**Kyle Fields**, El Dorado Hills, CA (US)
- (73) Assignee: **HAIR WORKS LLC**, Walnut Creek, CA (US)
- (\*\*) Term: **15 Years**
- (21) Appl. No.: **29/683,329**
- (22) Filed: **Mar. 12, 2019**
- (51) **LOC (12) Cl.** ..... **28-03**
- (52) **U.S. Cl.**  
USPC ..... **D28/21; D28/93**
- (58) **Field of Classification Search**  
USPC ..... **D28/7, 20-34, 93**  
(Continued)

(56) **References Cited**

U.S. PATENT DOCUMENTS

- D282,291 S \* 1/1986 Harvey ..... D28/21
  - D405,227 S \* 2/1999 Lucero ..... D28/21
- (Continued)

*Primary Examiner* — Zenia I Bennett

(74) *Attorney, Agent, or Firm* — Jim H. Salter; Inventive Law Inc.

(57) **CLAIM**

The ornamental design for a hair extension styling apparatus, as shown and described.

**DESCRIPTION**

A portion of the disclosure of this patent document contains material to which a claim for copyright is made. The

copyright owner has no objection to the facsimile reproduction by anyone of the patent document or the patent disclosure, as it appears in the Patent and Trademark Office patent file or records, but reserves all other copyrights whatsoever. FIG. 1 is a perspective view of the hair extension styling apparatus, in accordance with an embodiment of the present invention;

FIG. 2 is a top view of the hair extension styling apparatus, in accordance with an embodiment of the present invention; FIG. 3 is a front view of the hair extension styling apparatus, in accordance with an embodiment of the present invention; FIG. 4 is a side view of the hair extension styling apparatus, in accordance with an embodiment of the present invention; FIG. 5 is a rear view of the hair extension styling apparatus, in accordance with an embodiment of the present invention; FIG. 6 is a bottom view of the hair extension styling apparatus, in accordance with an embodiment of the present invention;

FIG. 7 is a perspective view of the hair extension styling apparatus, in accordance with an alternative embodiment of the present invention;

FIG. 8 is a top view of the hair extension styling apparatus, in accordance with an alternative embodiment of the present invention;

FIG. 9 is a front view of the hair extension styling apparatus, in accordance with an alternative embodiment of the present invention;

FIG. 10 is a side view of the hair extension styling apparatus, in accordance with an alternative embodiment of the present invention;

FIG. 11 is a rear view of the hair extension styling apparatus, in accordance with an alternative embodiment of the present invention; and,

FIG. 12 is a bottom view of the hair extension styling apparatus, in accordance with an alternative embodiment of the present invention.

**1 Claim, 12 Drawing Sheets**

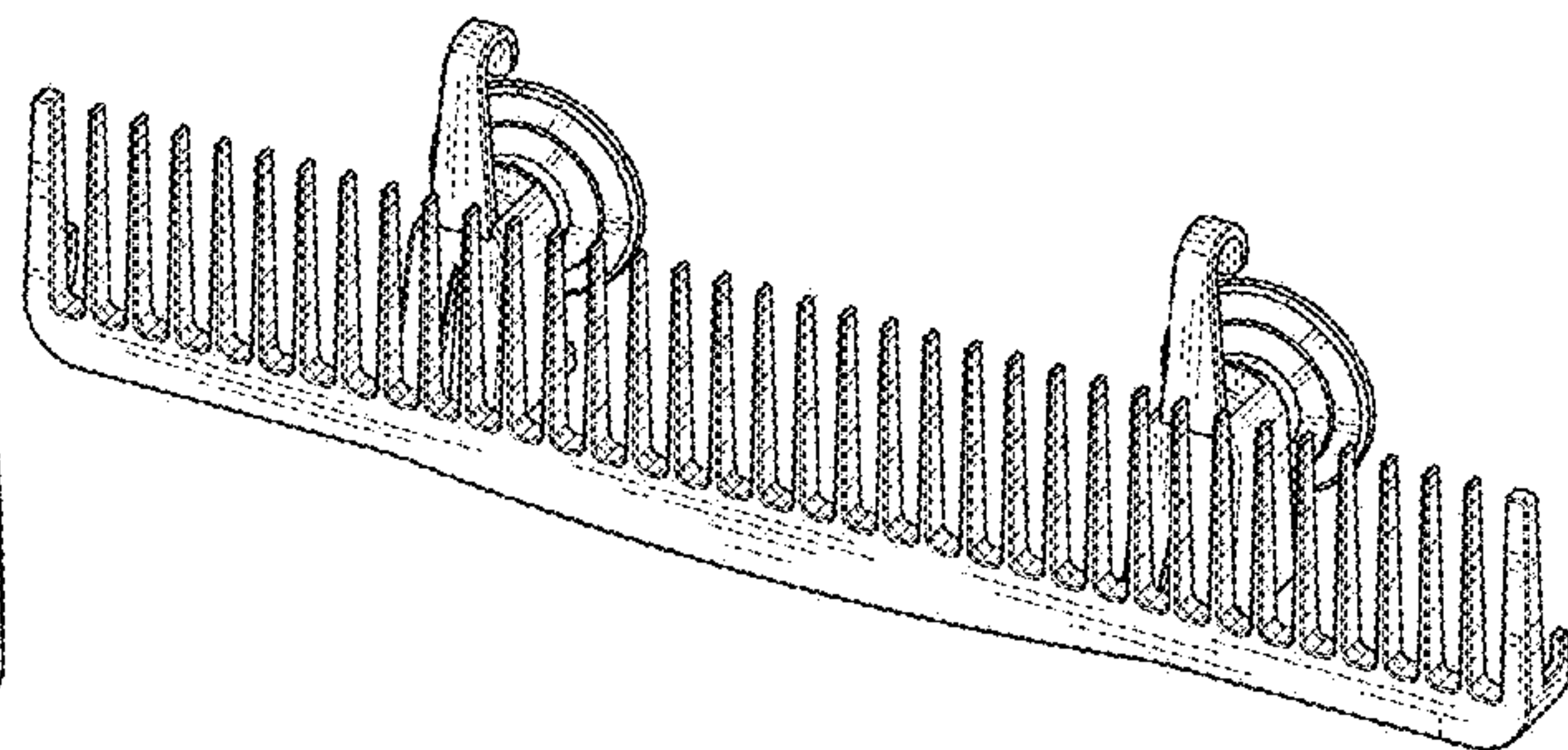
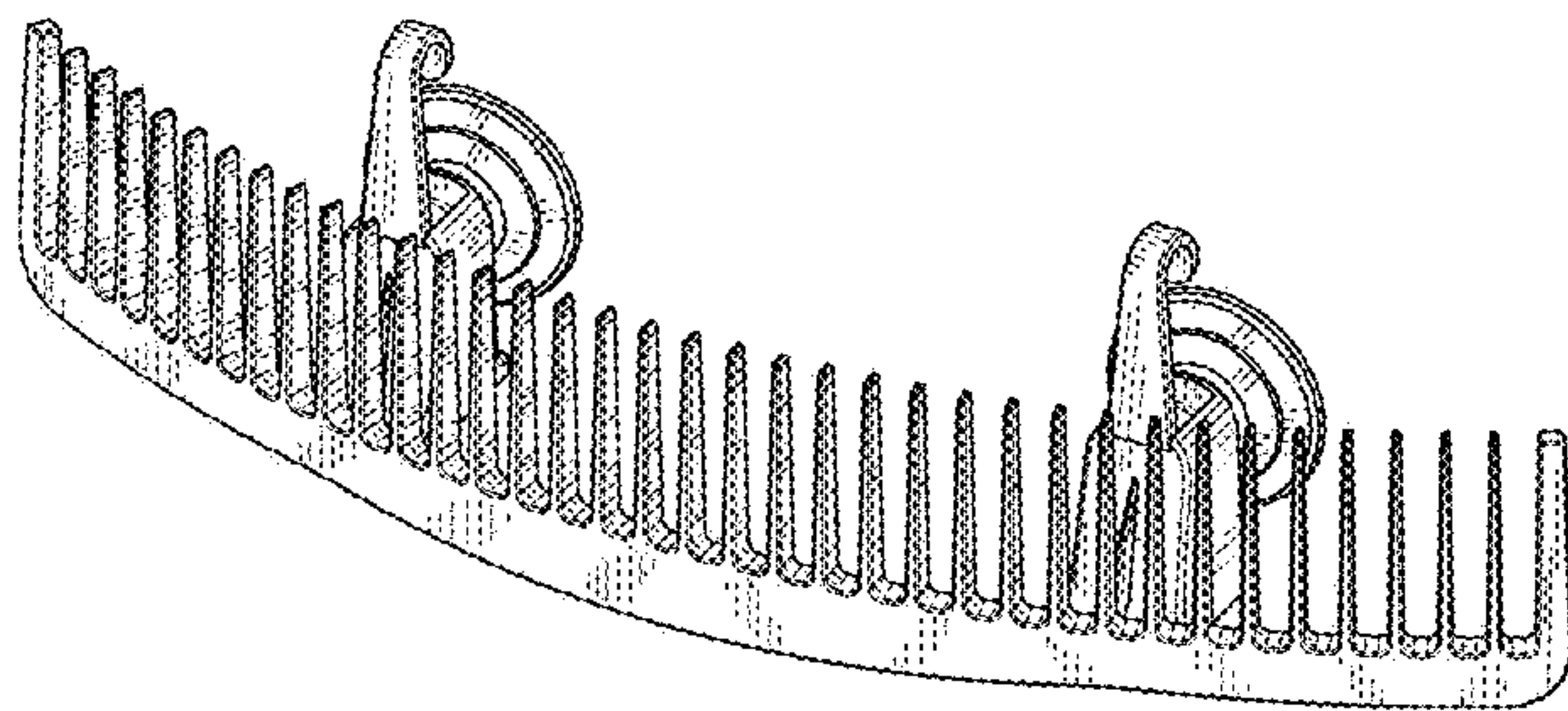

(58) **Field of Classification Search**

CPC ..... A45D 24/00; A45D 44/02; A41G 5/004

See application file for complete search history.

(56) **References Cited**

U.S. PATENT DOCUMENTS

D405,228	S	*	2/1999	Lucero	.....	D28/21
D644,376	S	*	8/2011	Morrill	.....	D28/21
D644,426	S		9/2011	Skaggs		
D723,741	S		3/2015	Caplan		
9,332,820	B2		5/2016	Bernard		
D768,337	S		10/2016	Treb		
D796,740	S	*	9/2017	Burton	.....	D28/21
D796,741	S	*	9/2017	Burton	.....	D28/21
2006/0289368	A1		12/2006	Abney		
2009/0008347	A1		1/2009	Bell		
2011/0284397	A1		11/2011	Batres		
2013/0104922	A1		5/2013	Hall		
2014/0191634	A1		7/2014	Smiley		
2015/0196143	A1		7/2015	Sterling		
2015/0257515	A1		9/2015	Bernard		
2015/0351562	A1		12/2015	Kebreau		
2015/0351574	A1		12/2015	Eslami		

\* cited by examiner



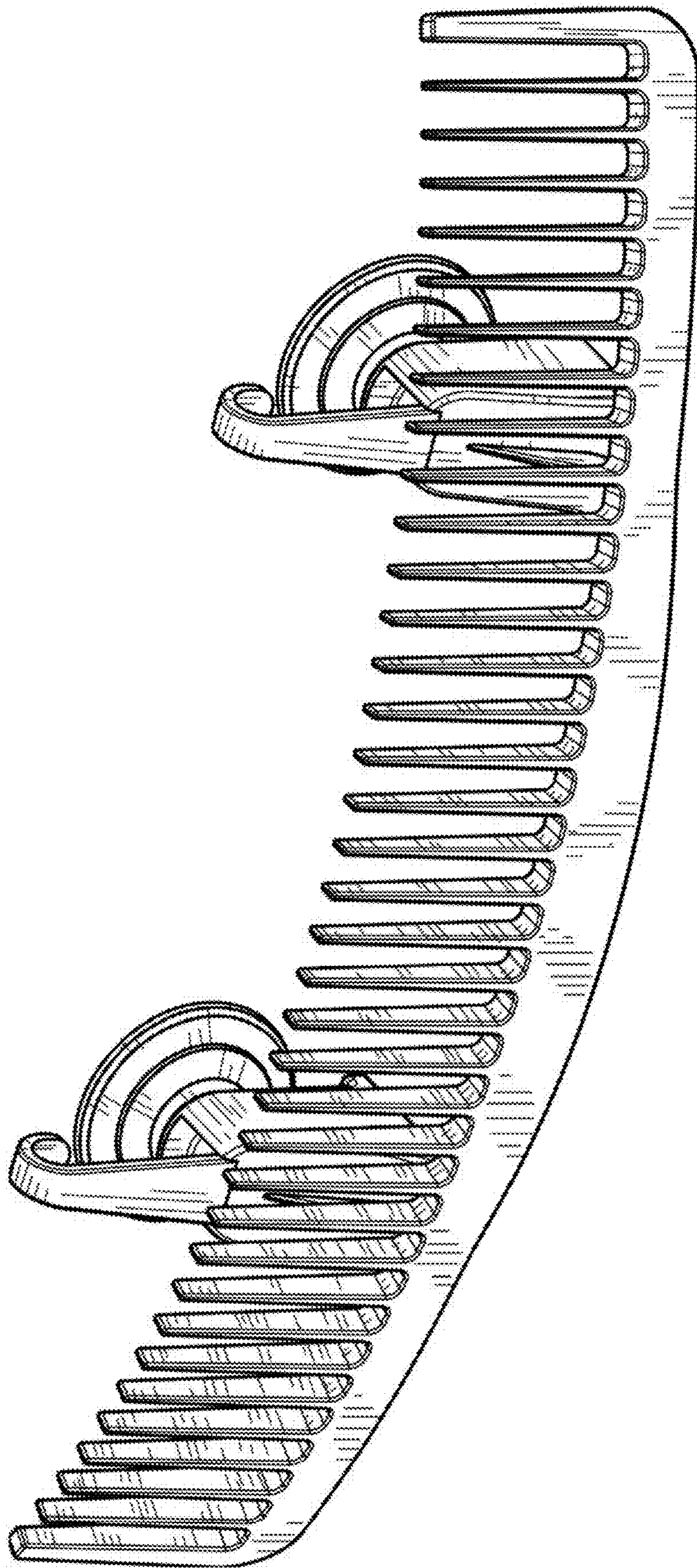

Fig. 1

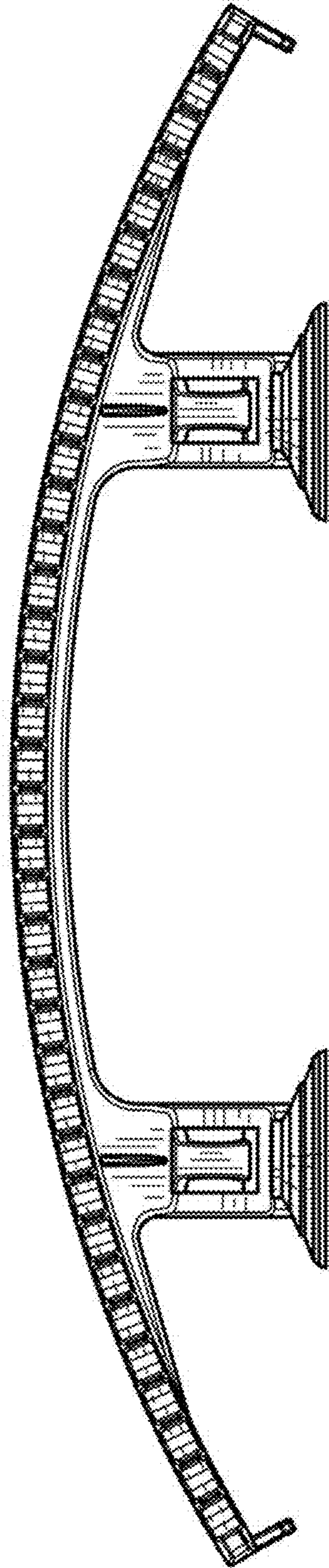

Fig. 2



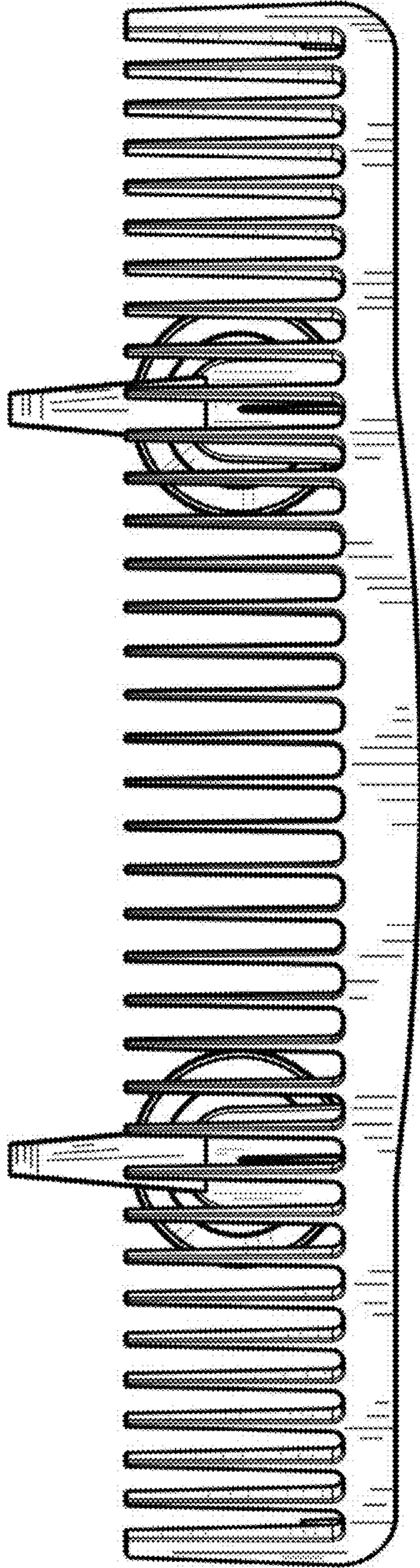

Fig. 3

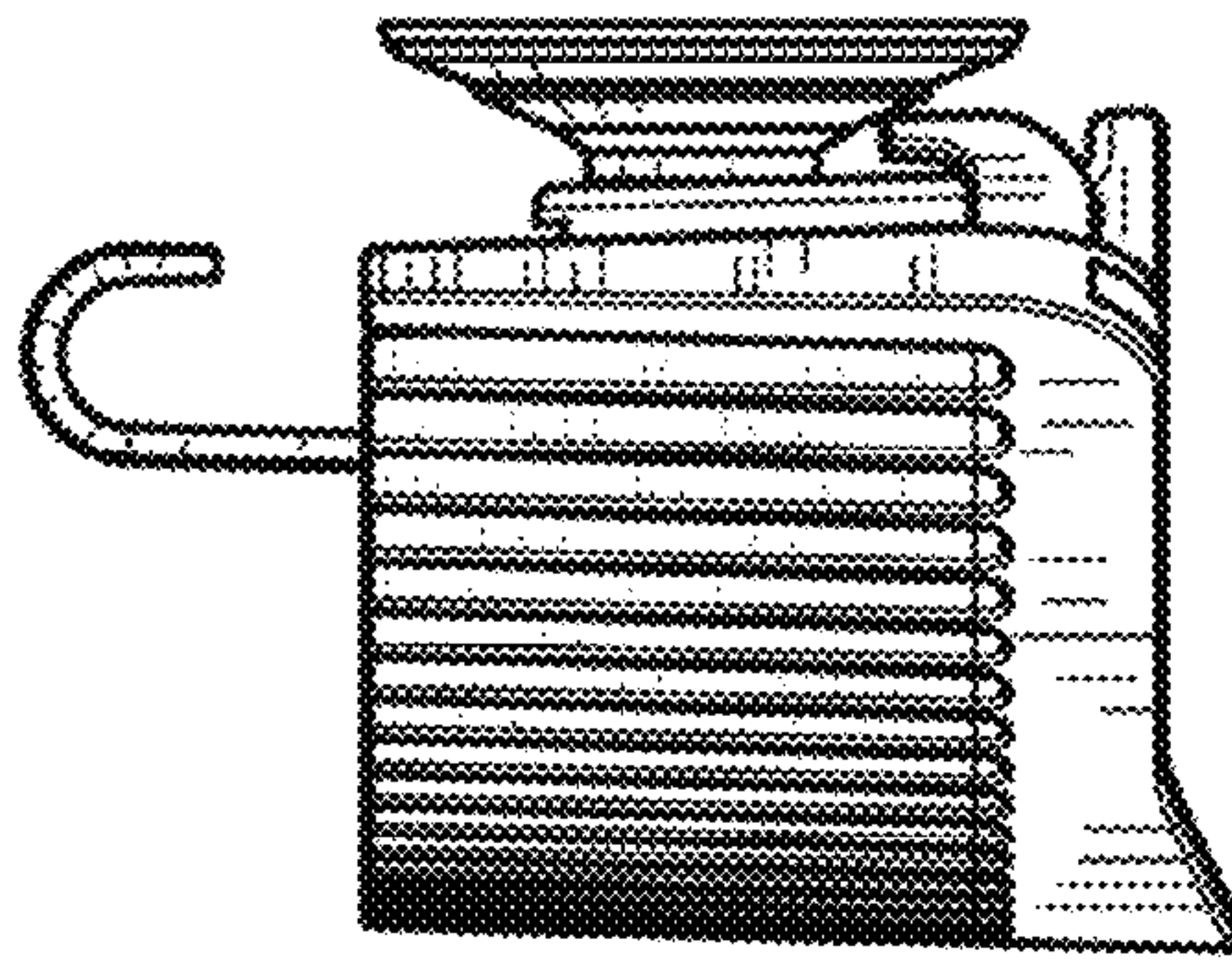

Fig. 4

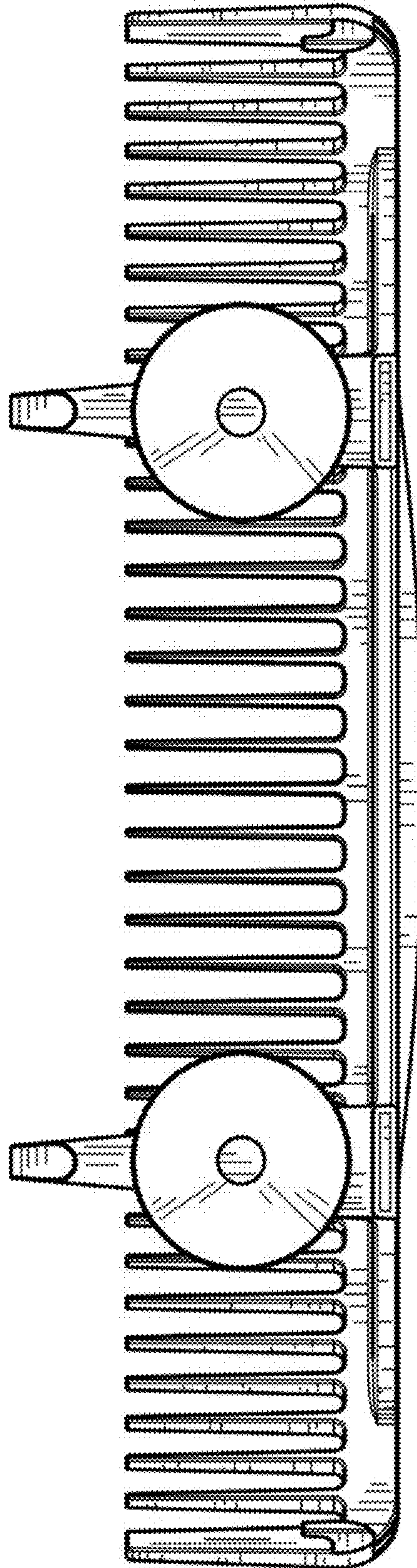

Fig. 5



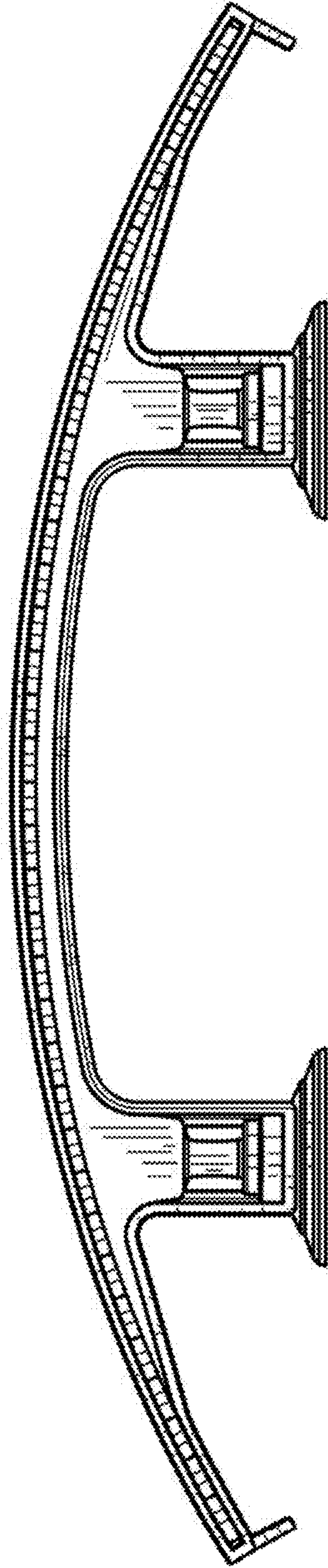

Fig. 6



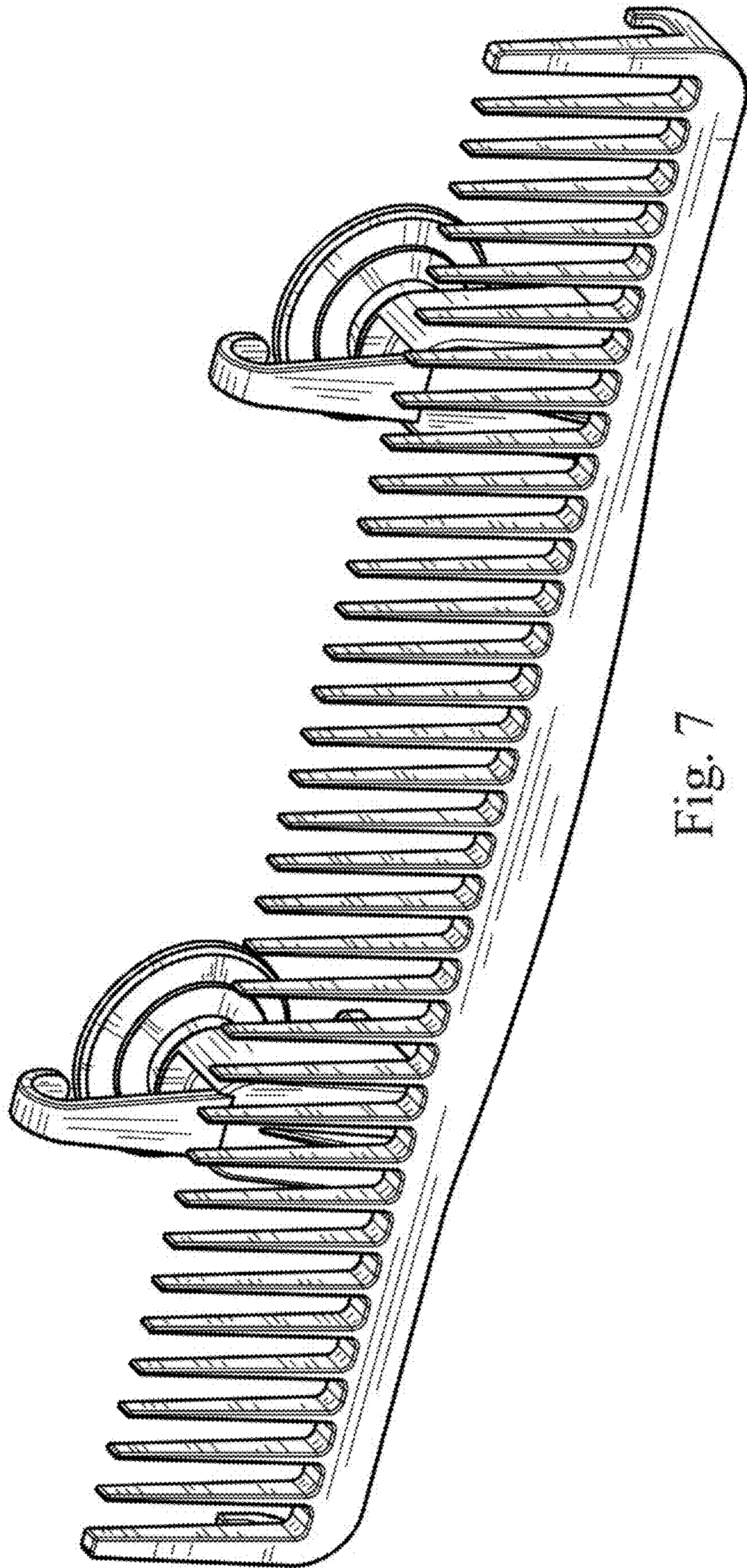

Fig. 7

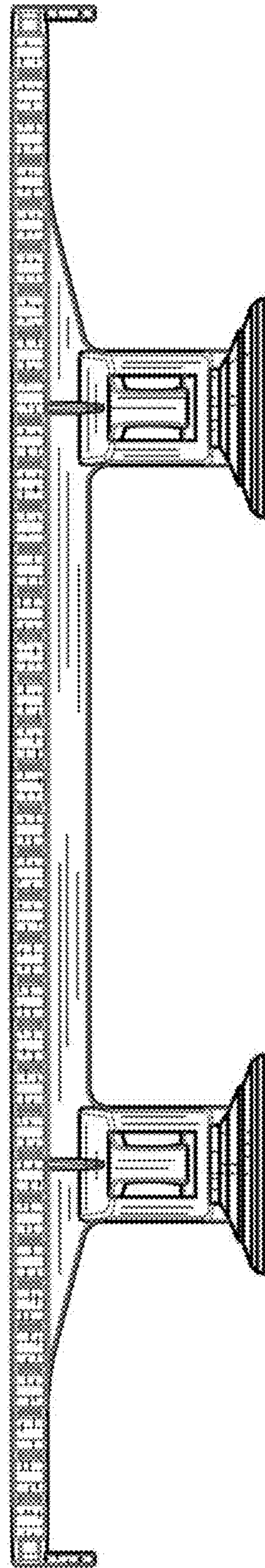

Fig. 8



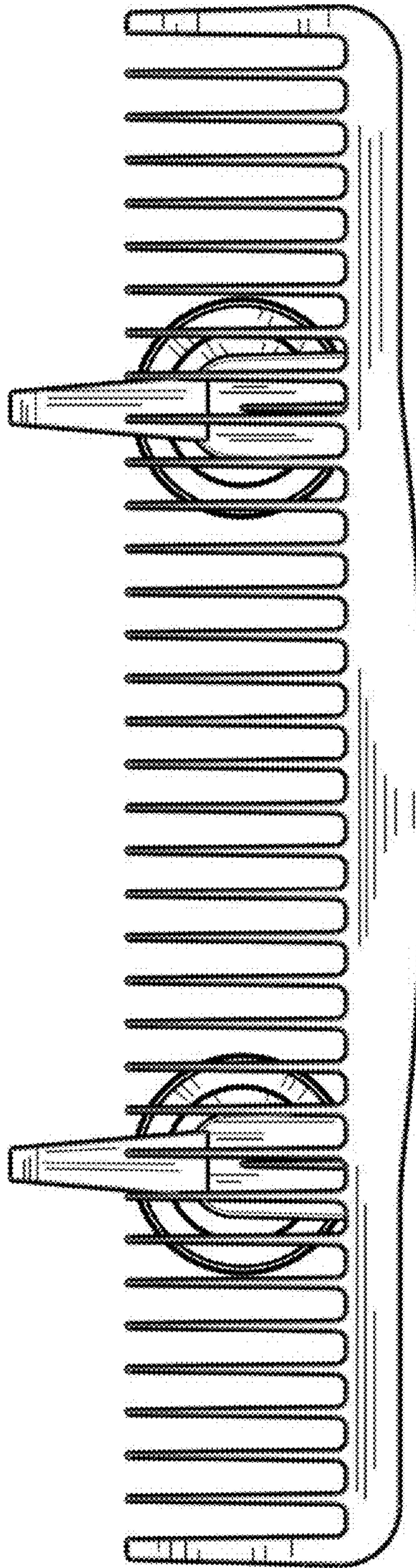

Fig. 9



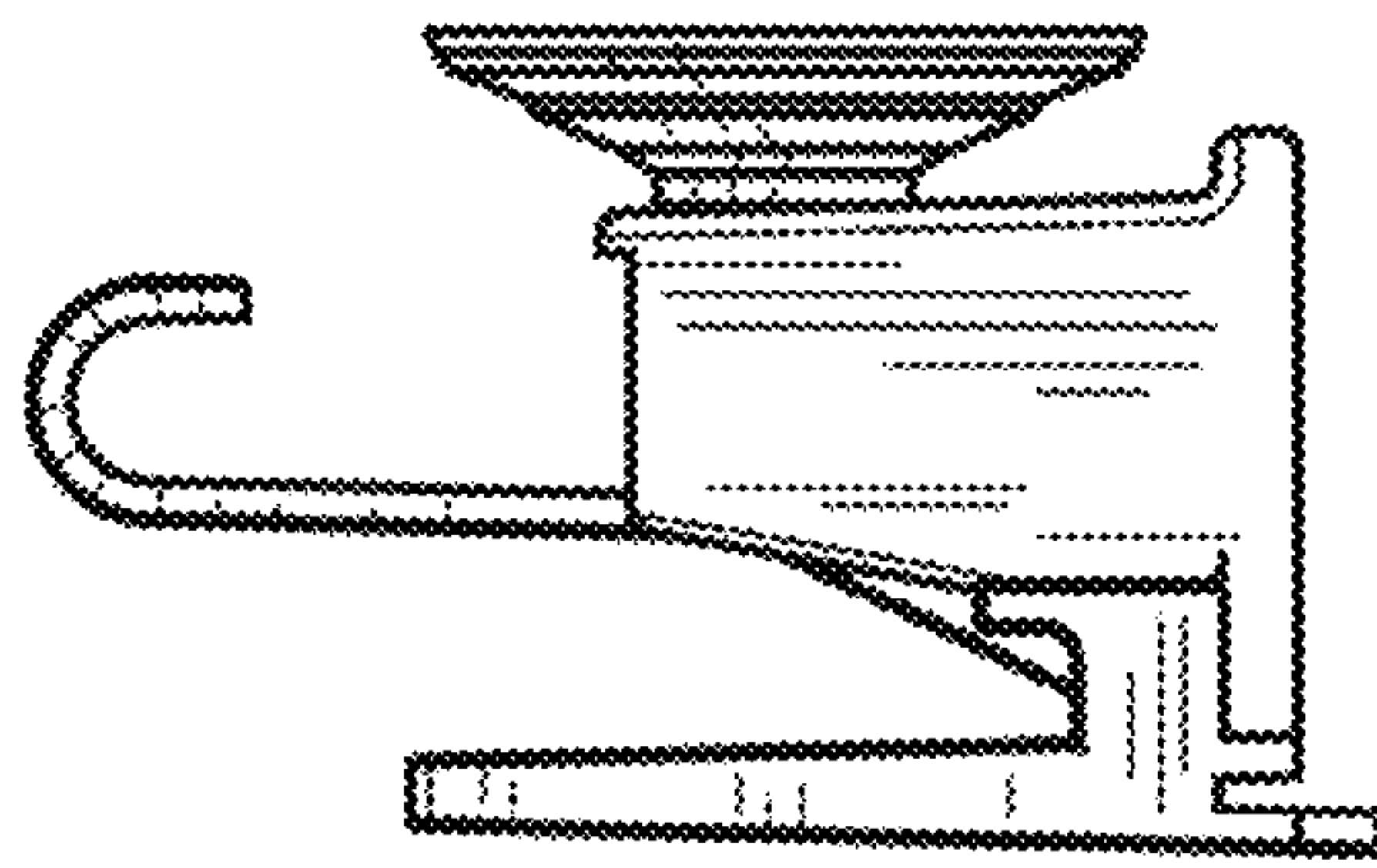

Fig. 10

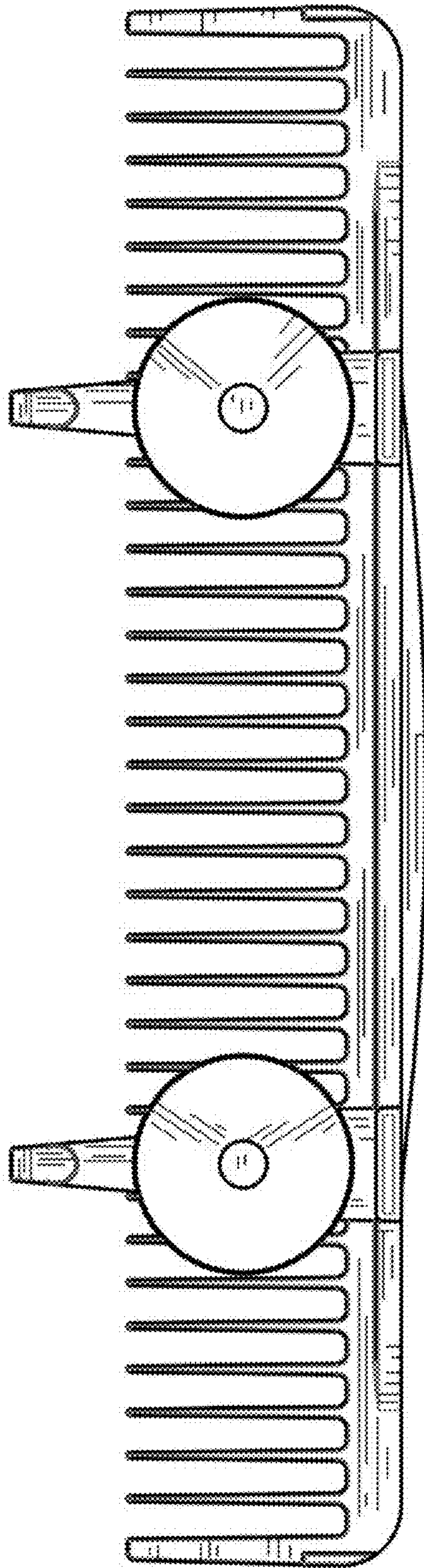

Fig. 11

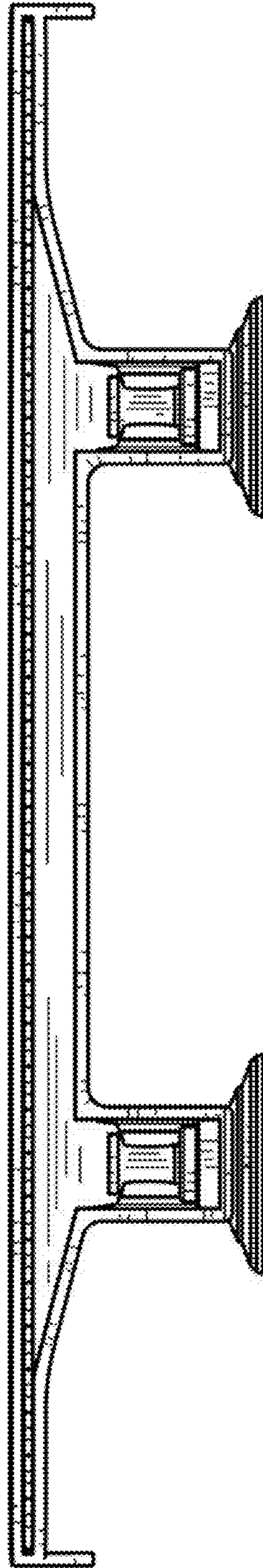

Fig. 12