



US00D889010S

(12) **United States Design Patent**
Ormsbee et al.

(10) **Patent No.:** **US D889,010 S**
(45) **Date of Patent:** **** Jun. 30, 2020**

(54) **PERSONAL LIGHTING DEVICE**
(71) Applicant: **Nite Ize, Inc.**, Boulder, CO (US)
(72) Inventors: **Bowden Ormsbee**, Longmont, CO (US); **Steven L. Lindquist**, Broomfield, CO (US)

D614,017 S * 4/2010 Bender D8/356
D617,925 S * 6/2010 Coughaine D26/37
D740,474 S * 10/2015 Pineau D26/37
D801,569 S * 10/2017 Ormsbee D26/37
D825,804 S * 8/2018 Okuda D26/60
D850,680 S * 6/2019 Case D26/37

* cited by examiner

(73) Assignee: **Nite Ize, Inc.**, Boulder, CO (US)

Primary Examiner — Abraham Bahta

(**) Term: **15 Years**

(74) *Attorney, Agent, or Firm* — Haynes and Boone, LLP

(21) Appl. No.: **29/671,991**

(57) **CLAIM**

(22) Filed: **Nov. 30, 2018**

The ornamental design for the personal lighting device, as shown and described.

(51) **LOC (12) Cl.** **26-02**

(52) **U.S. Cl.**
USPC **D26/37**

DESCRIPTION

(58) **Field of Classification Search**
USPC D26/1, 24, 25, 43, 60, 110, 113, 28, 37,
D26/61, 85, 102, 138-140, 39;
362/249.14, 311.02, 311.13
CPC F21S 4/00; F21S 4/10; F21S 4/15; F21S
4/26; F21S 2/00; F21V 11/02; F21V
11/06; F21V 17/10; F21V 17/16; F21V
23/00; F21V 23/04; F21V 33/00; F21W
2121/00; F21W 2121/04; F21Y 2115/10;
F21L 4/00; F21L 4/02; F21L 4/04; F21L
4/08

FIG. 1 shows a front perspective view of a personal lighting device;
FIG. 2 shows a rear perspective view of the personal lighting device of FIG. 1;
FIG. 3 shows a front view of the personal lighting device of FIG. 1;
FIG. 4 shows a rear view of the personal lighting device of FIG. 1;
FIG. 5 shows a left-side view of the personal lighting device of FIG. 1;
FIG. 6 shows a right-side view of the personal lighting device of FIG. 1;
FIG. 7 shows a top view of the personal lighting device of FIG. 1; and,
FIG. 8 shows a bottom view of the personal lighting device of FIG. 1.

See application file for complete search history.

(56) **References Cited**

U.S. PATENT DOCUMENTS

D553,278 S * 10/2007 Moore D26/39
D588,291 S * 3/2009 VanderWoude D26/37

1 Claim, 3 Drawing Sheets

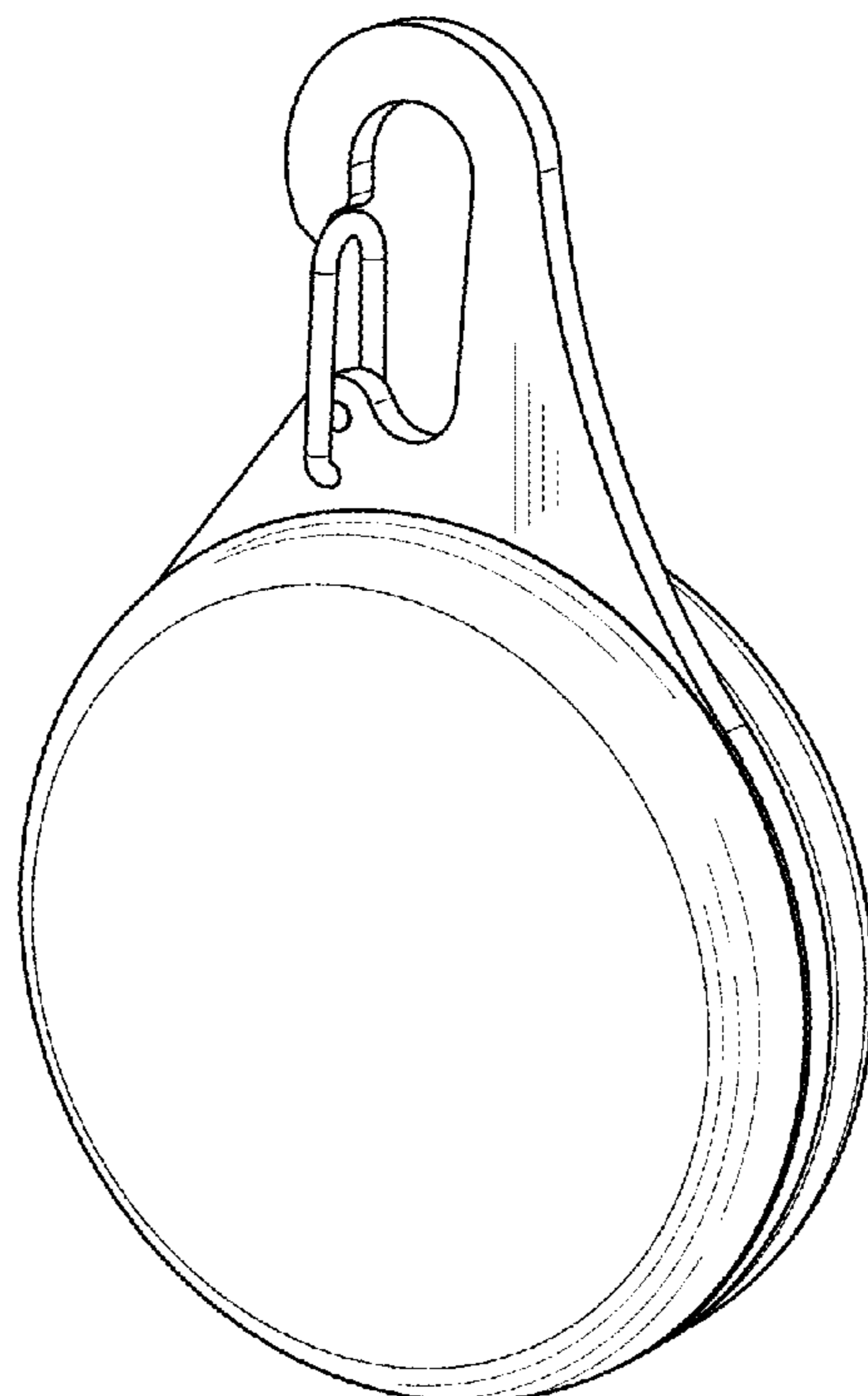

FIG. 1

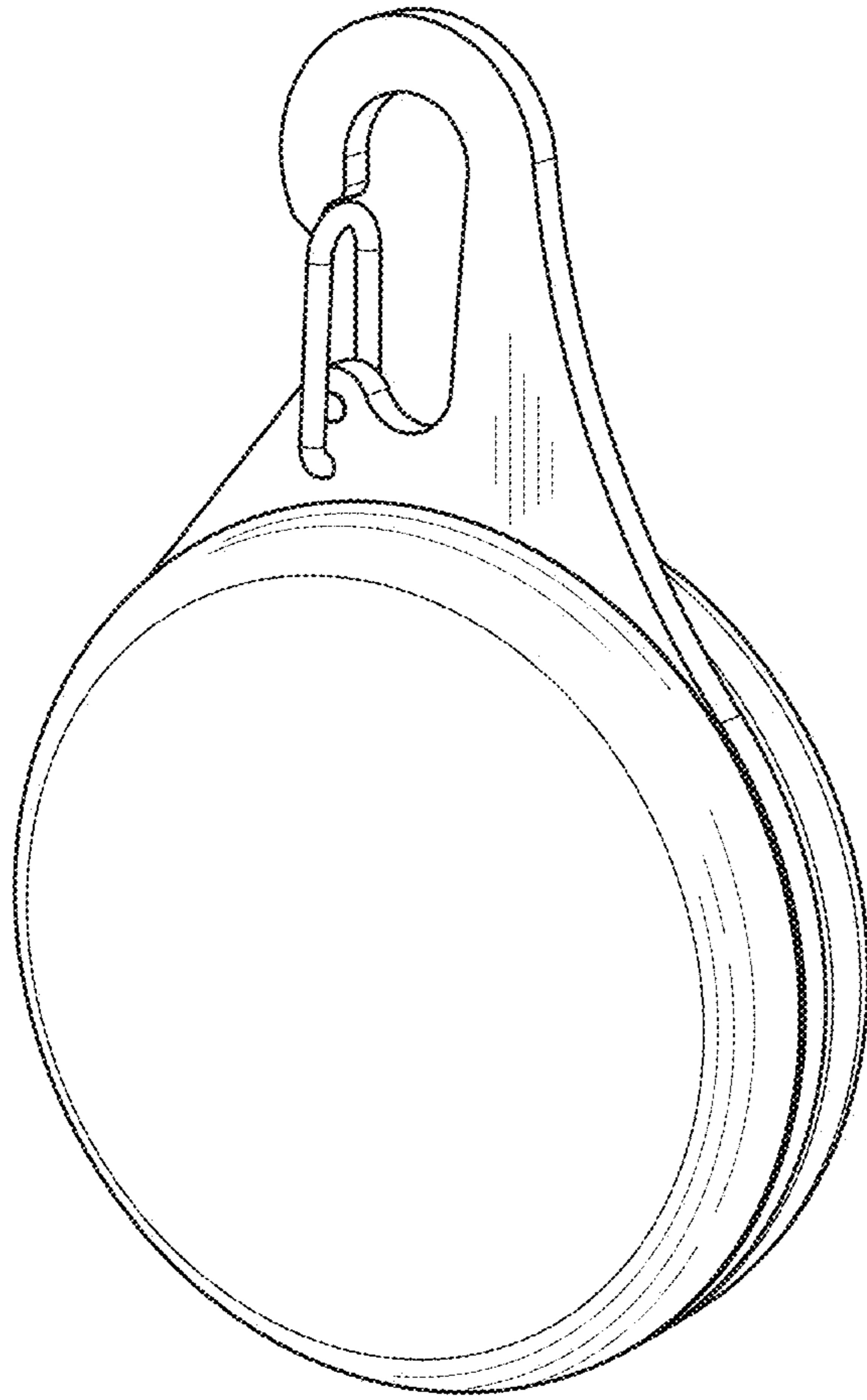

FIG. 2

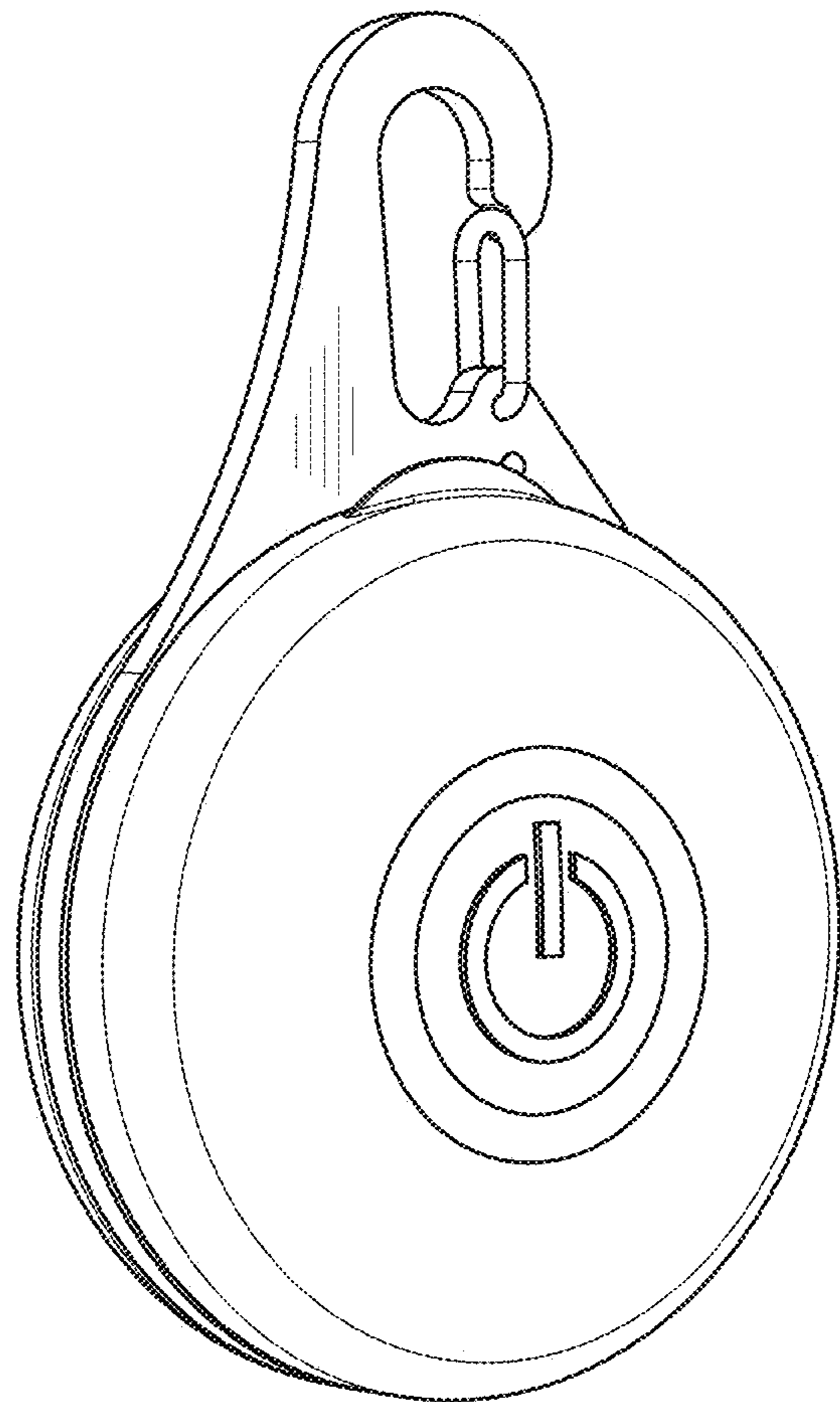

FIG. 3

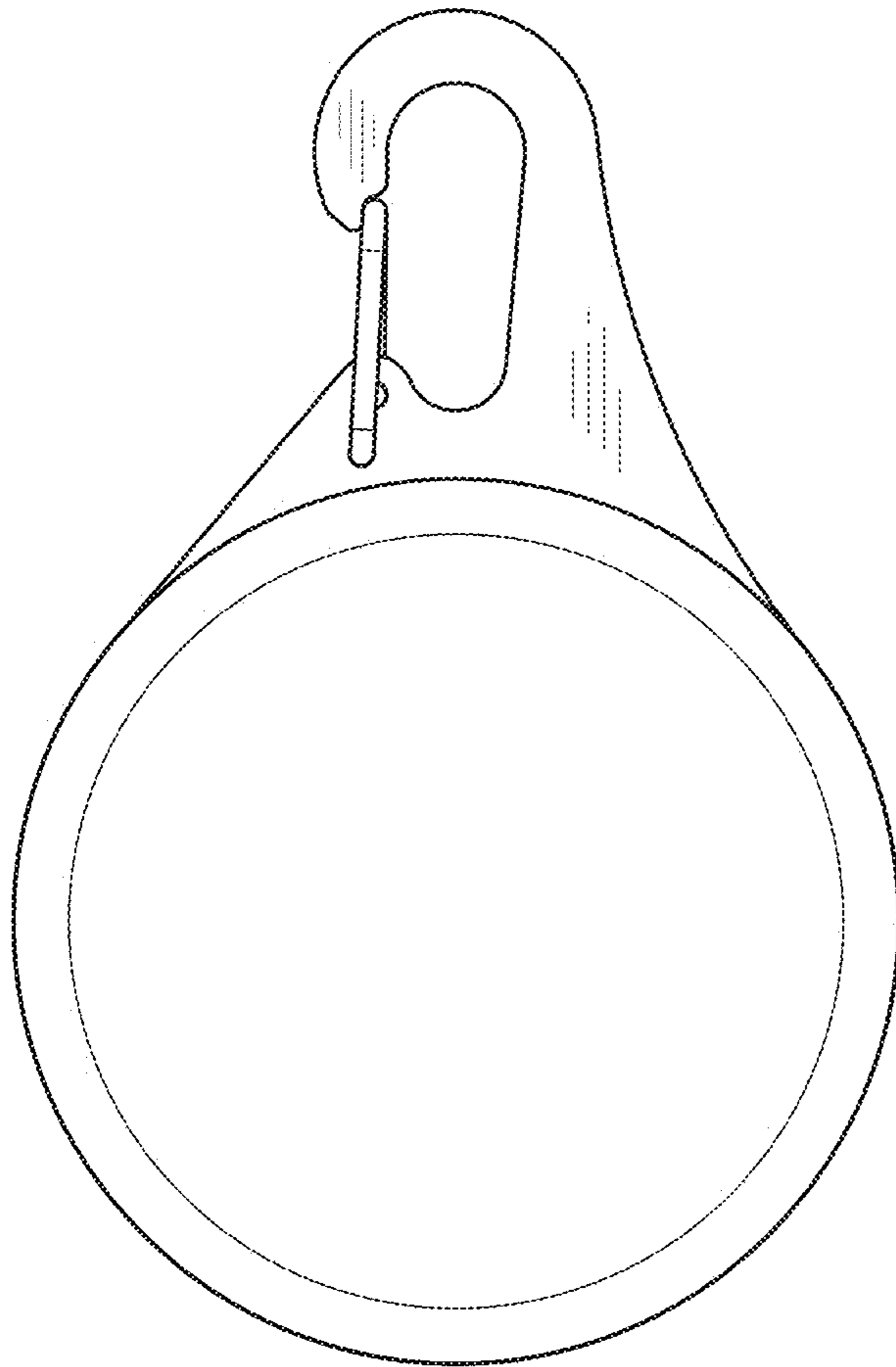

FIG. 4

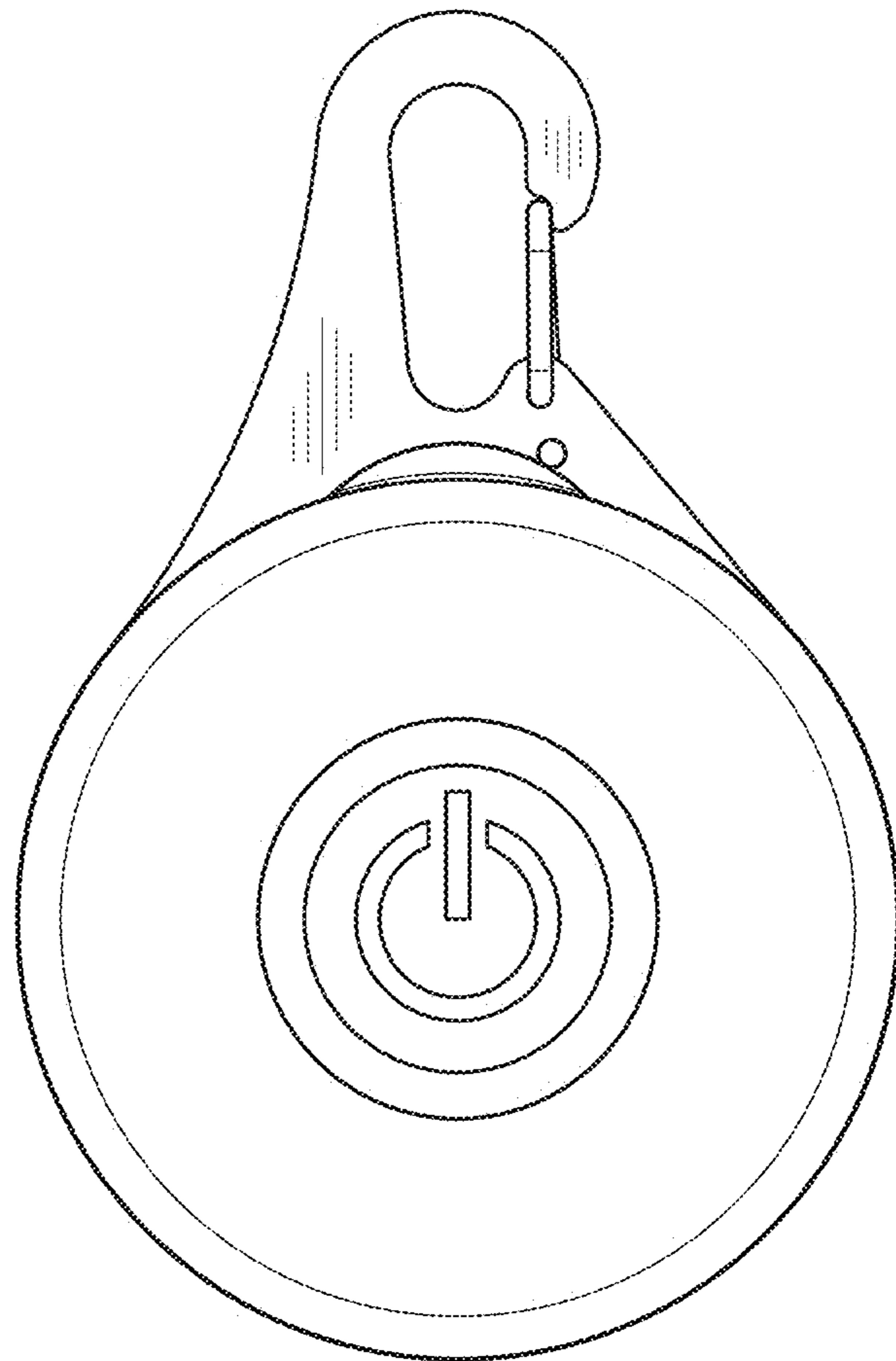

FIG. 5

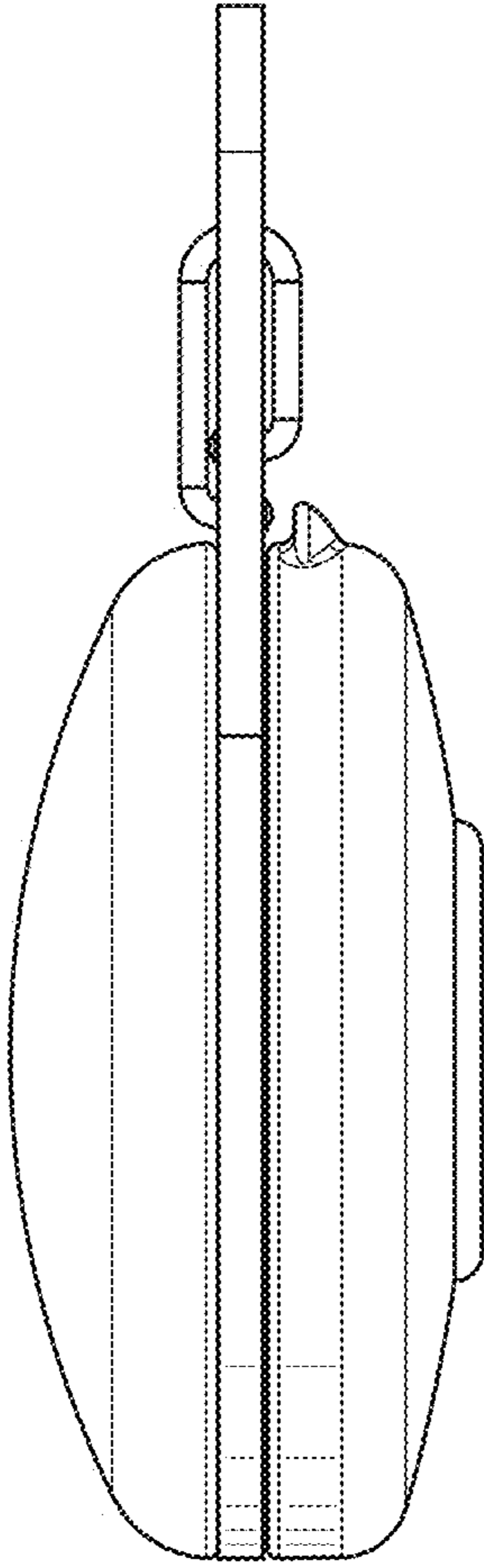

FIG. 6

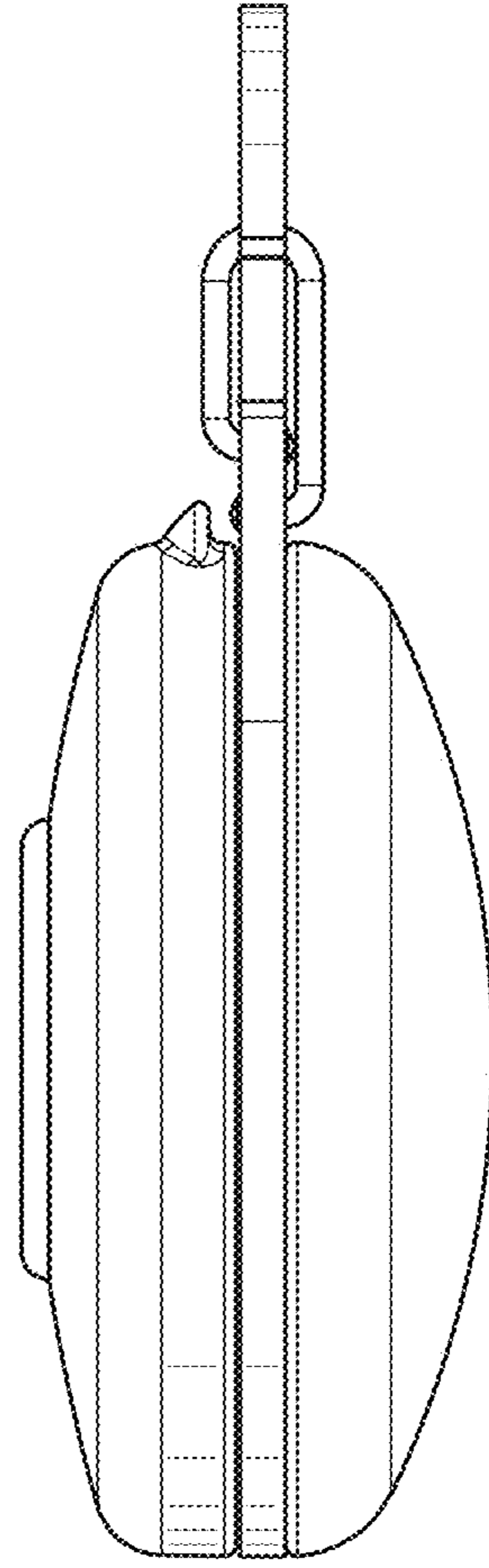

FIG. 7

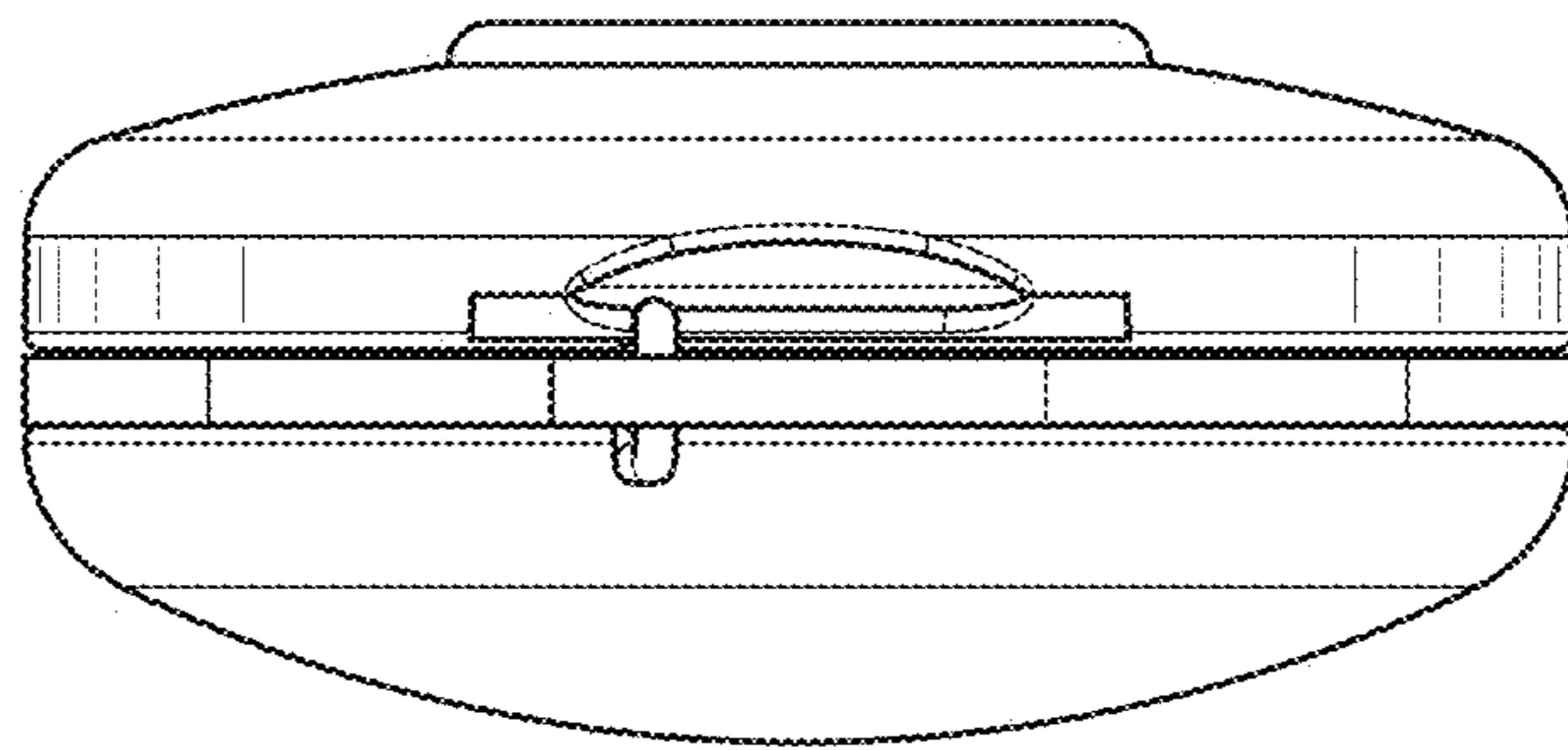

FIG. 8

