



US00D889003S

(12) **United States Design Patent**
He

(10) **Patent No.:** **US D889,003 S**

(45) **Date of Patent:** **** Jun. 30, 2020**

(54) **EXTERIOR SURFACE CONFIGURATION OF
A HEADLIGHT FOR A VEHICLE**

D728,137 S * 4/2015 Ha D26/28
D746,497 S * 12/2015 Behmer D26/28
D749,247 S * 2/2016 Han D26/28

(71) Applicant: **Arex Industries, Inc.**, Irwindale, CA
(US)

* cited by examiner

(72) Inventor: **Mizeng He**, TaiZhou (CN)

Primary Examiner — Marcus A Jackson

(**) Term: **15 Years**

(74) *Attorney, Agent, or Firm* — Theodore S. Lee, Esq.

(21) Appl. No.: **29/686,199**

(22) Filed: **Apr. 2, 2019**

(51) **LOC (12) Cl.** **26-06**

(52) **U.S. Cl.**
USPC **D26/28**

(58) **Field of Classification Search**
USPC D26/28–36, 139
CPC F21S 48/00; F21S 48/10; F21S 48/115;
F21S 48/225; F21S 48/1233; F21S
48/1266; F21S 48/1388; F21S 48/2268;
F21V 21/04; F21V 29/004; B60Q 9/13;
B60Q 9/135; B60Q 9/1375

See application file for complete search history.

(56) **References Cited**

U.S. PATENT DOCUMENTS

D409,772 S * 5/1999 Bangle D26/28
D675,353 S * 1/2013 Kazama D26/28
D693,037 S * 11/2013 Jeong D26/28
D696,444 S * 12/2013 Ishizuka D26/28
D716,478 S * 10/2014 Loeb D26/28

(57) **CLAIM**

The ornamental design for an exterior surface configuration of a headlight for a vehicle, as shown and described.

DESCRIPTION

FIG. 1 is a perspective view of an exterior surface configuration of a headlight for a vehicle according to the novel design;

FIG. 2 is left side view thereof;

FIG. 3 is a front view thereof;

FIG. 4 is a right side view thereof;

FIG. 5 is a back side view thereof;

FIG. 6 is an alternative perspective view thereof; and,

FIG. 7 is a top view thereof.

The broken lines are for environmental purposes only and form no part of the claimed design. The design shown is not to be limited to any particular size and may be scaled larger or smaller. The drawings and descriptions represent the right side embodiment. The claim is also for a mirror image of a left side embodiment that is not shown.

1 Claim, 7 Drawing Sheets

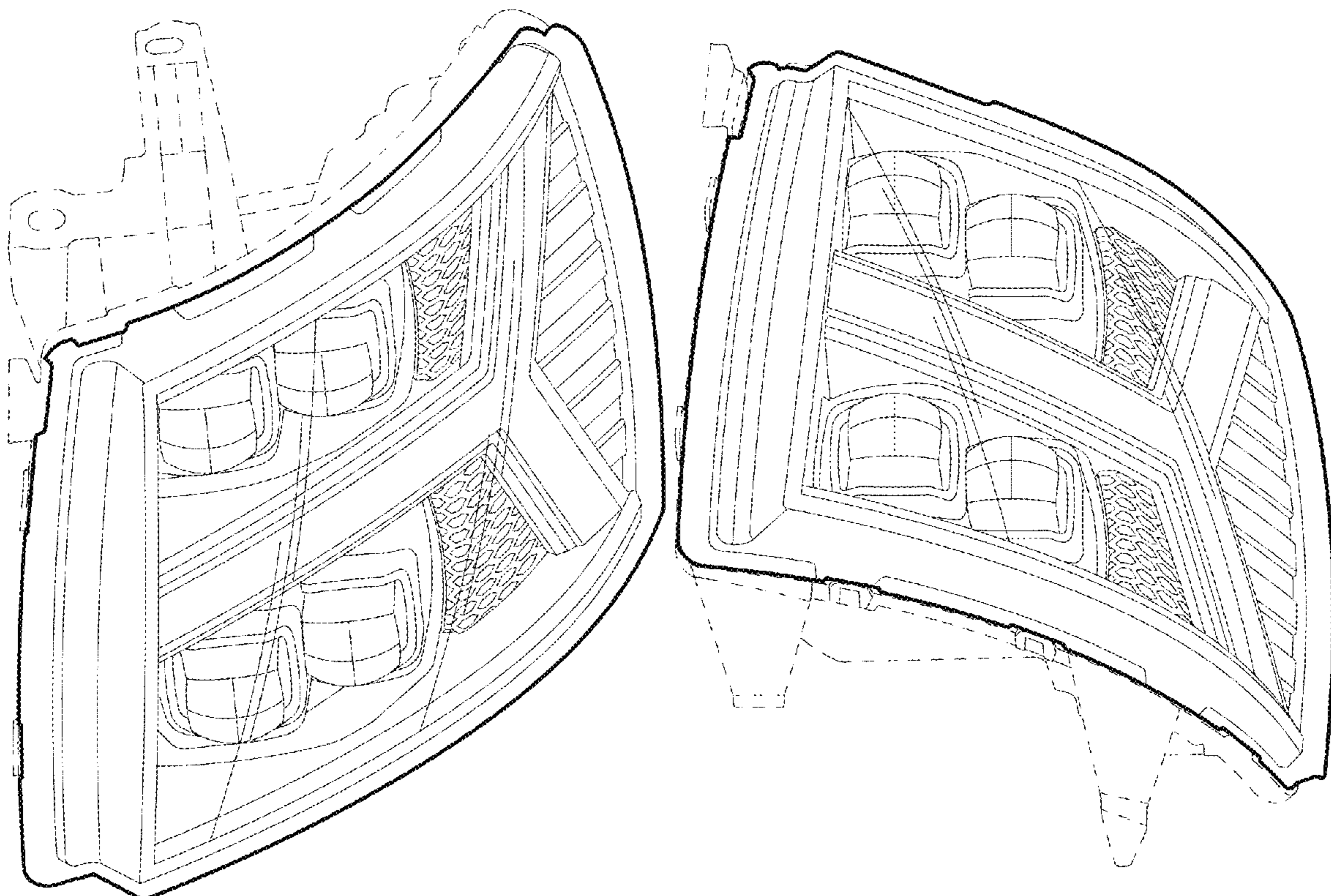

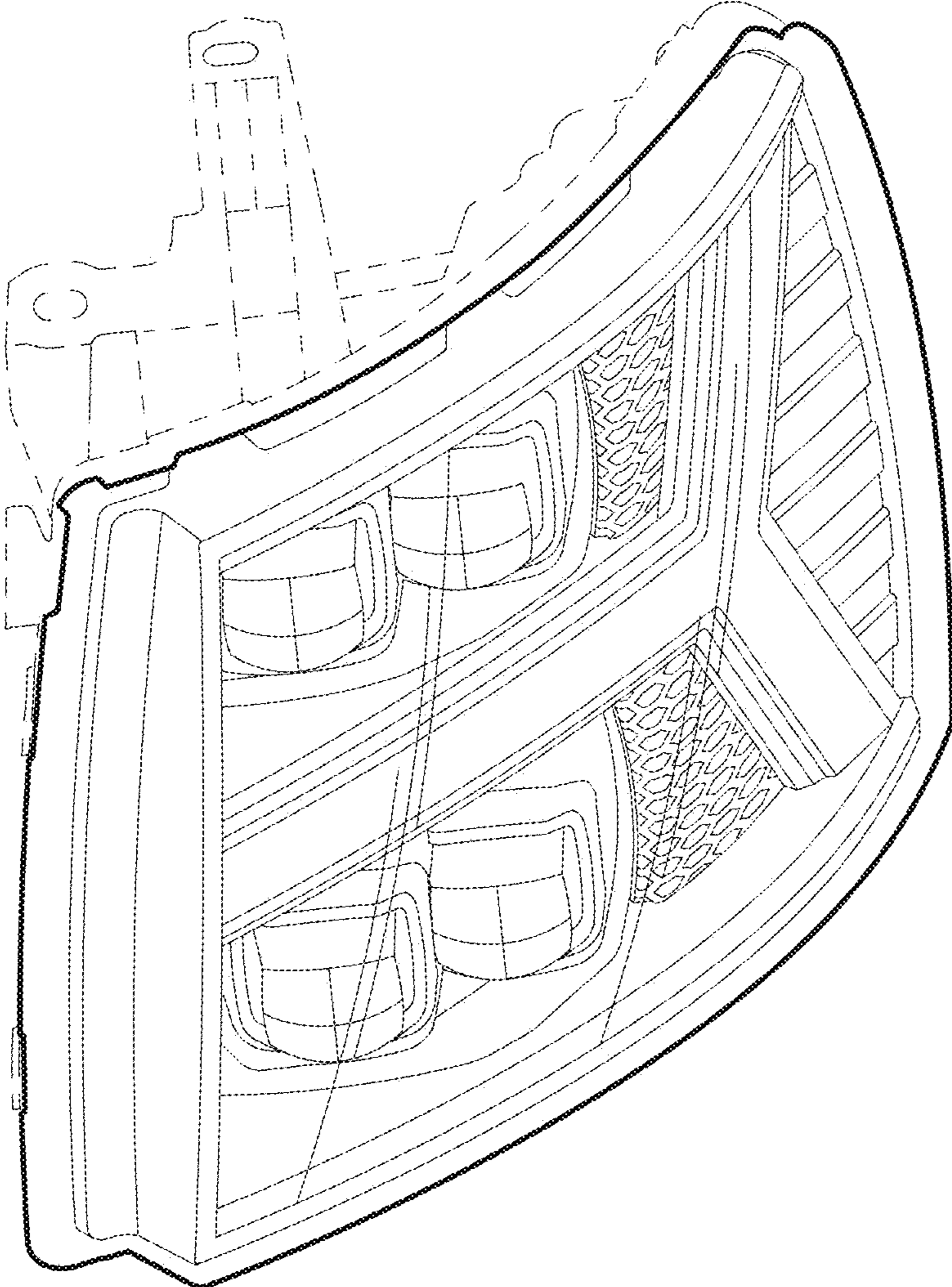

FIG. 1

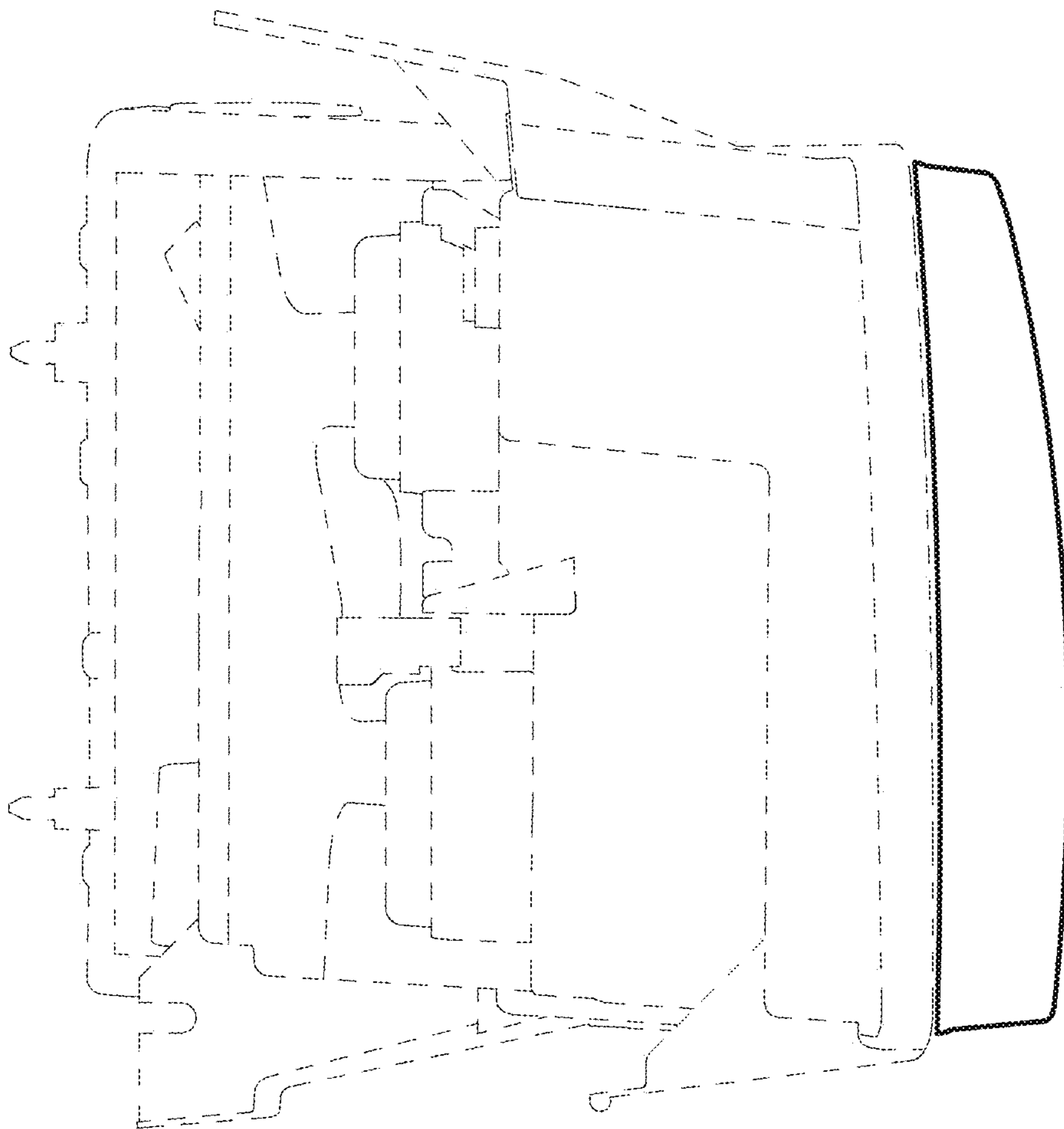

FIG. 2

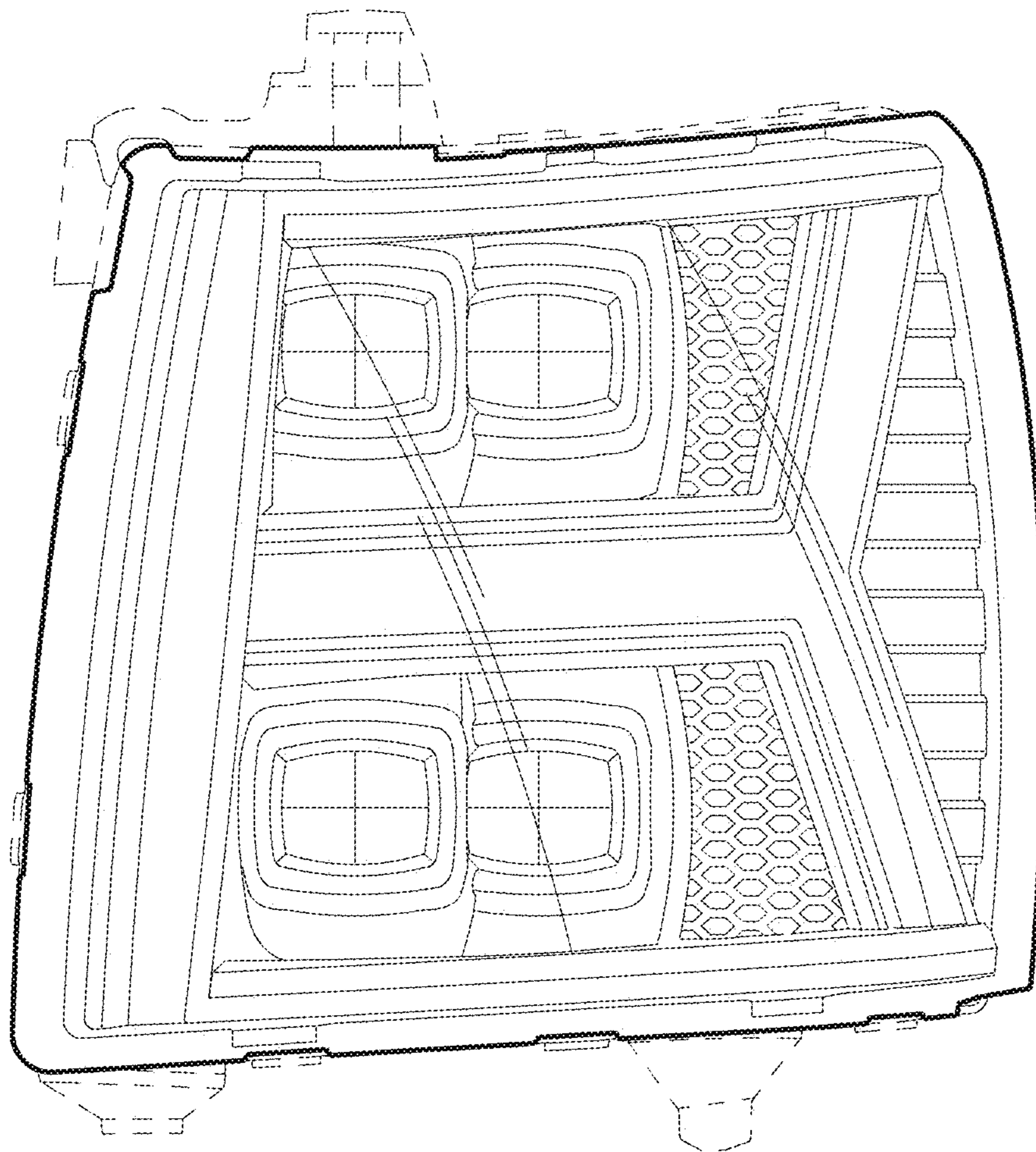

FIG. 3

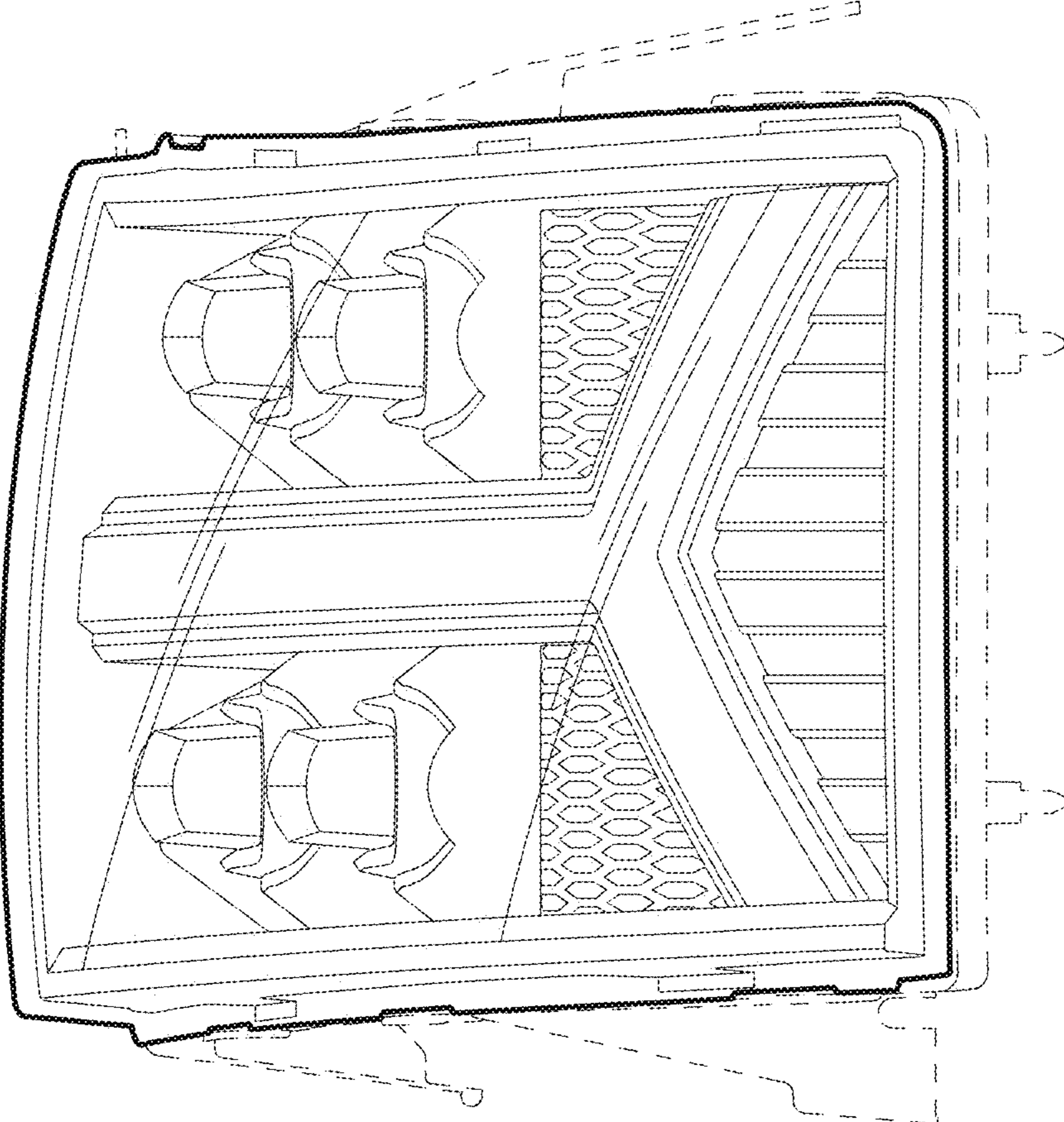

FIG. 4

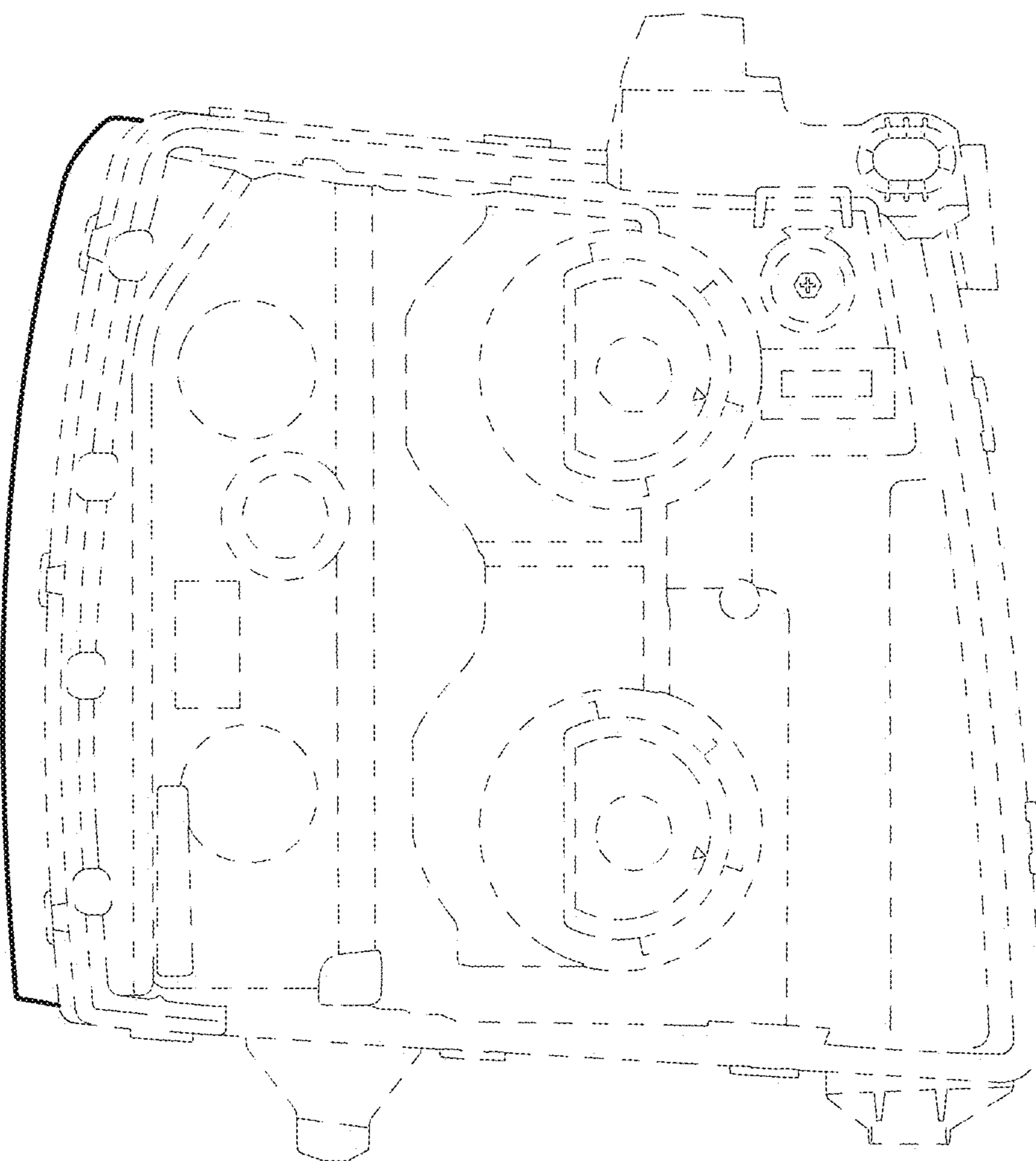

FIG. 5

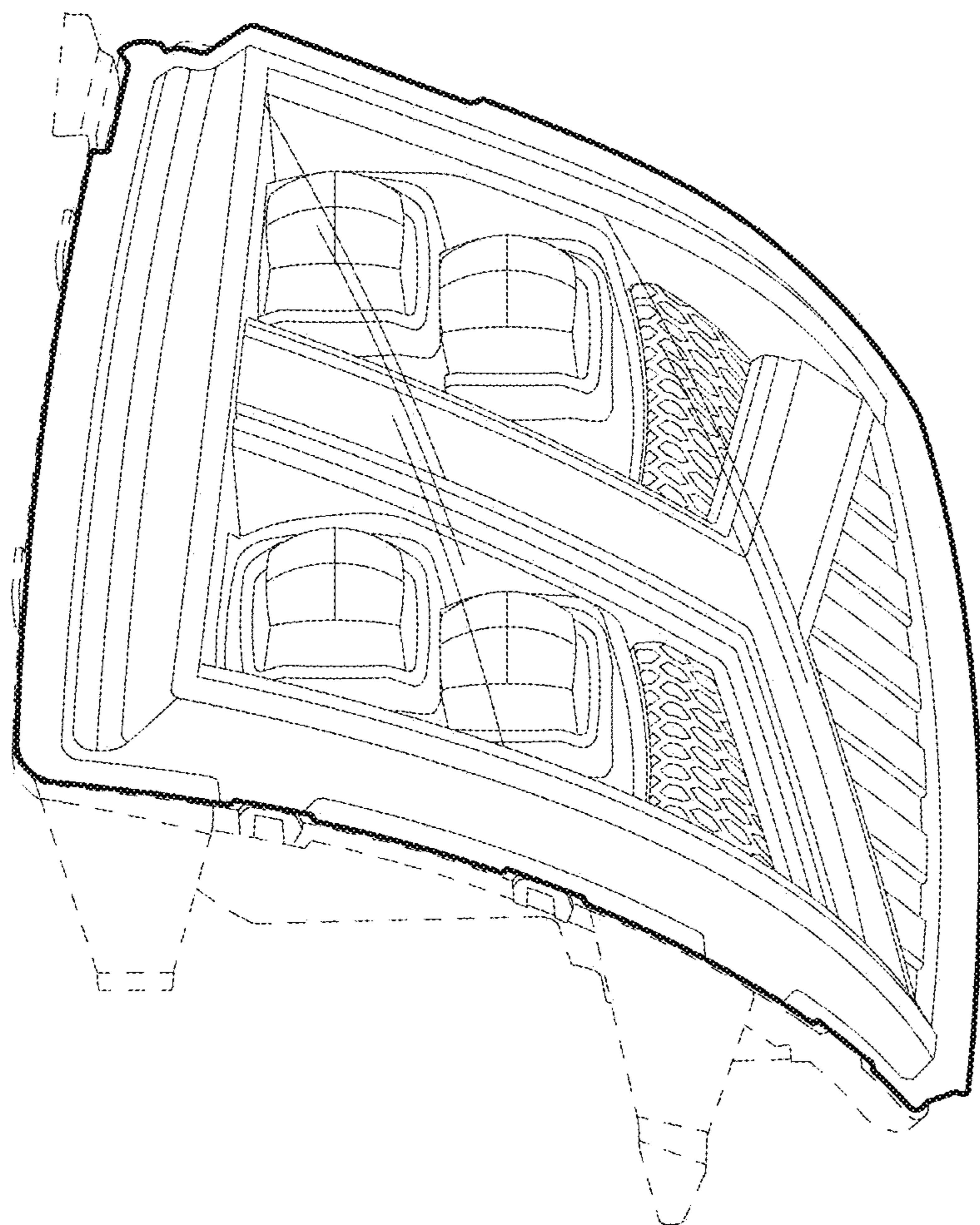

FIG. 6

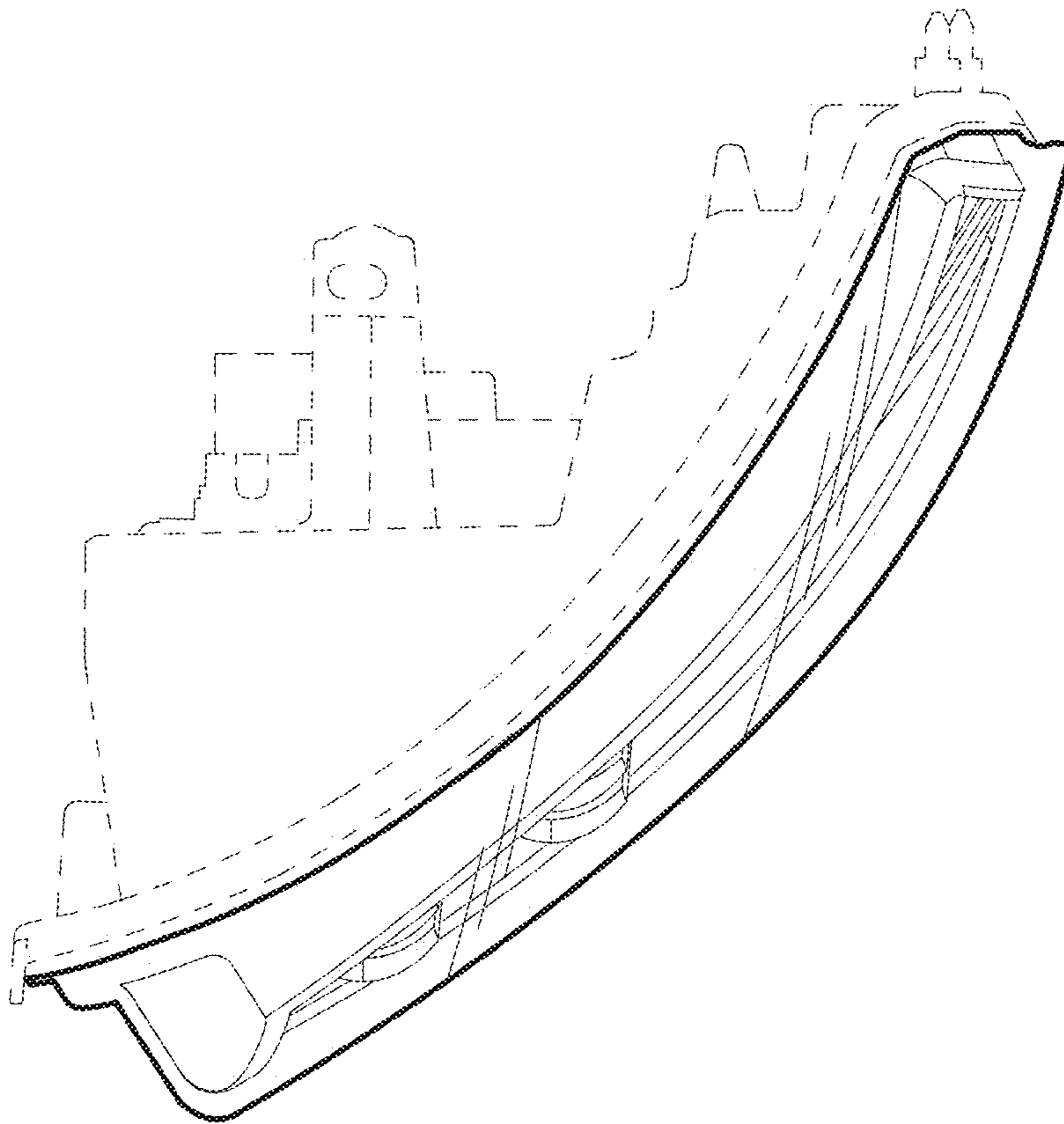

FIG. 7