



US00D888998S

(12) **United States Design Patent**
Wu

(10) **Patent No.:** **US D888,998 S**

(45) **Date of Patent:** **** Jun. 30, 2020**

(54) **VEHICLE LIGHT**

(71) Applicant: **COPLUS INC.**, Tainan (TW)

(72) Inventor: **Po-Hua Wu**, Tainan (TW)

(73) Assignee: **COPLUS INC.**, Tainan (TW)

(**) Term: **15 Years**

(21) Appl. No.: **29/650,435**

(22) Filed: **Jun. 6, 2018**

(30) **Foreign Application Priority Data**

Jan. 12, 2018 (TW) 107300227

(51) **LOC (12) Cl.** **26-06**

(52) **U.S. Cl.**
USPC **D26/28**

(58) **Field of Classification Search**

USPC D12/86, 90-92, 114, 163, 169, 171-173,
D12/181, 190, 196, 197, 199, 400;
D26/28-36

CPC ... B62J 6/02; B62J 6/00; B60Q 3/0279; F21S
48/00; F21S 48/10; F21S 48/115; F21S
48/225; F21S 48/1233; F21S 48/1266;
F21S 48/1388; F21S 48/2268; F21V
21/04

See application file for complete search history.

(56) **References Cited**

U.S. PATENT DOCUMENTS

D476,761 S * 7/2003 Lin D26/28
D493,550 S * 7/2004 Lin D26/28

D526,728 S * 8/2006 Lin D26/28
D563,001 S * 2/2008 Sato D26/28
D745,717 S * 12/2015 Wu D26/28
D866,019 S * 11/2019 Herzog D26/28
D870,937 S * 12/2019 Wu D26/28

* cited by examiner

Primary Examiner — Philip S Hyder

Assistant Examiner — Cary M Robinson

(74) *Attorney, Agent, or Firm* — Lewis Roca Rothgerber
Christie LLP

(57) **CLAIM**

The ornamental design for a vehicle light, as shown and described.

DESCRIPTION

FIG. 1 is a perspective view of a vehicle light;
FIG. 2 is a front view thereof;
FIG. 3 is a rear view thereof;
FIG. 4 is a left side view thereof;
FIG. 5 is a right side view thereof;
FIG. 6 is a top view thereof; and,
FIG. 7 is a bottom view thereof.
The broken lines in the drawings illustrate portions of the vehicle light in which the design is embodied that form no part of the claimed design.

1 Claim, 6 Drawing Sheets

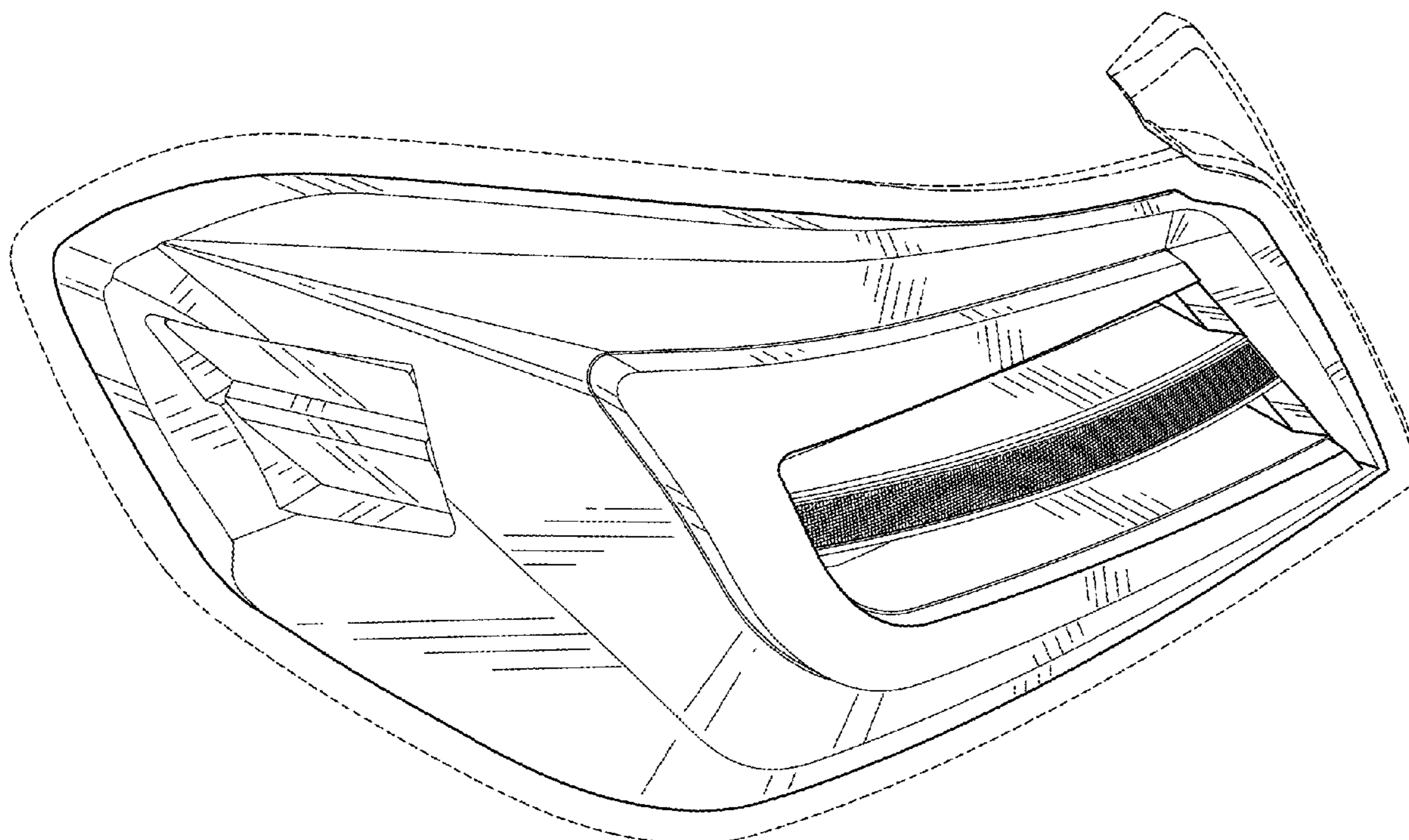

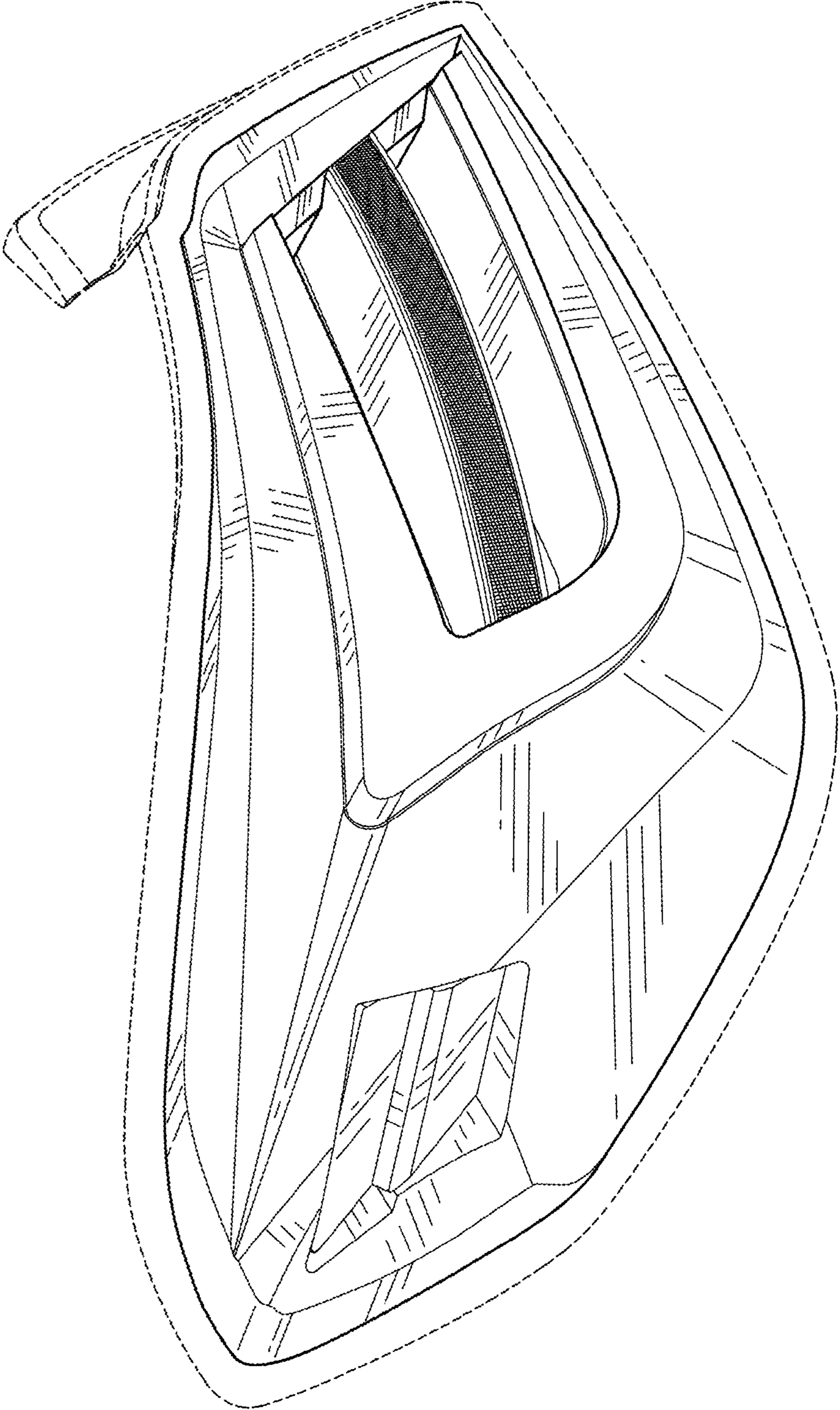

FIG. 1

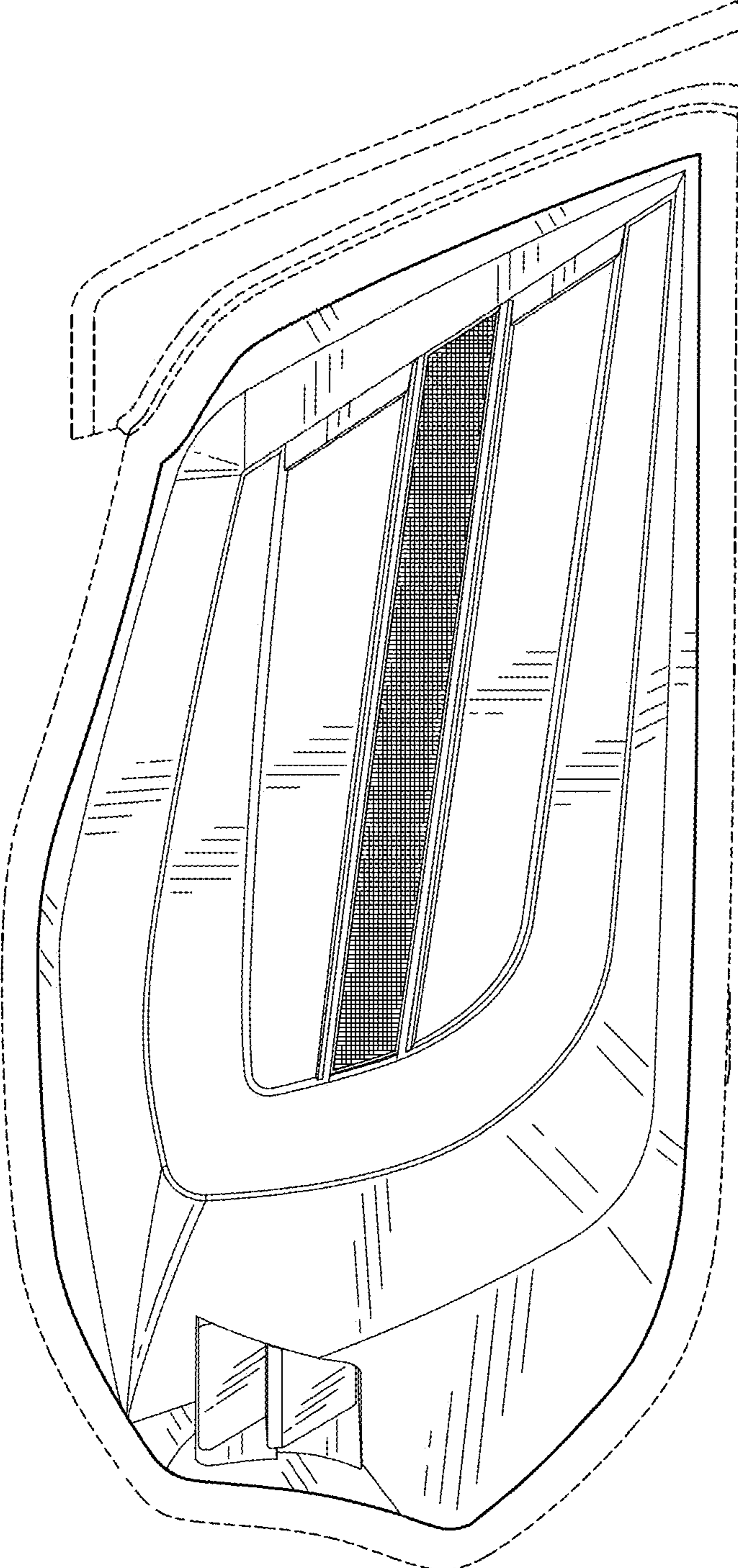

FIG. 2

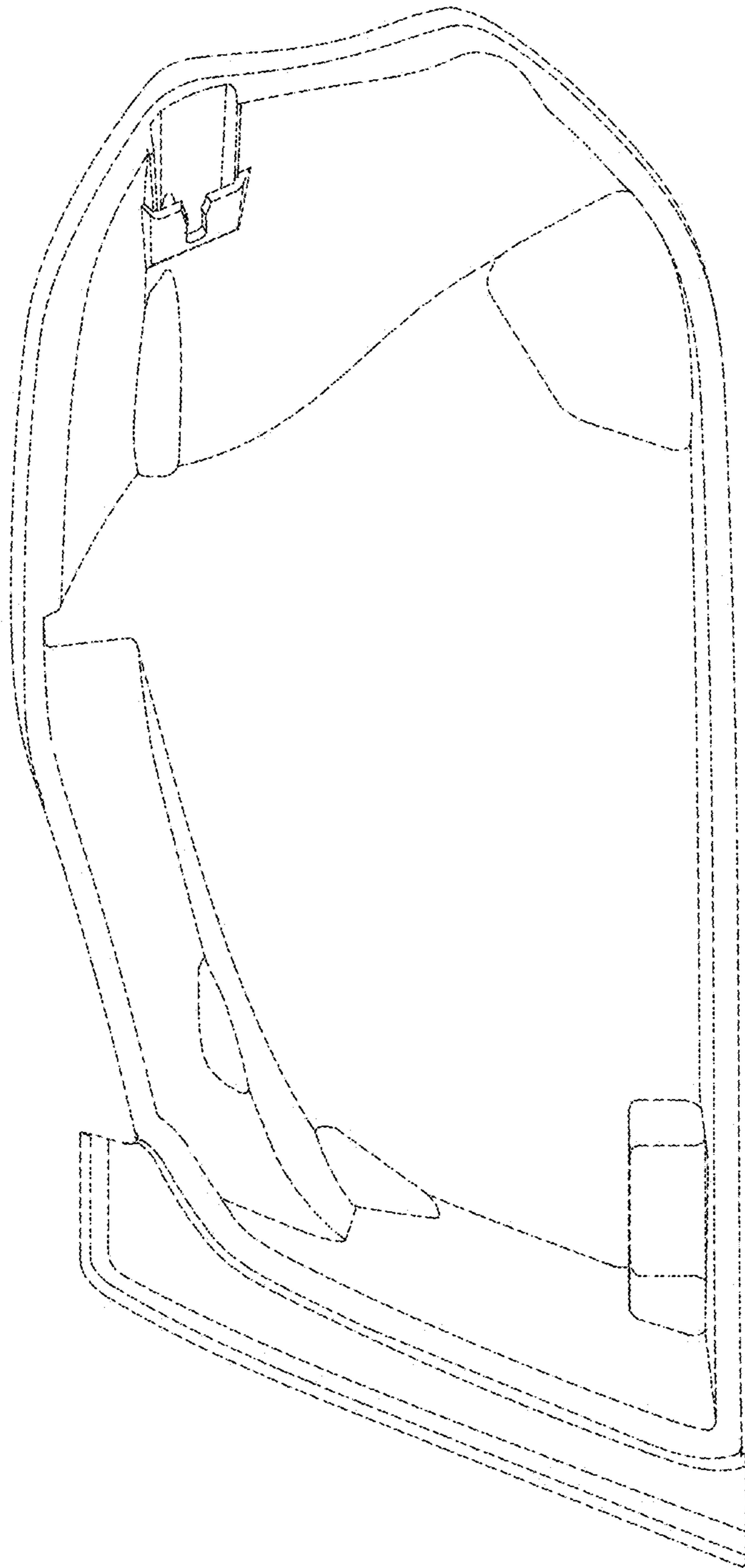

FIG. 3

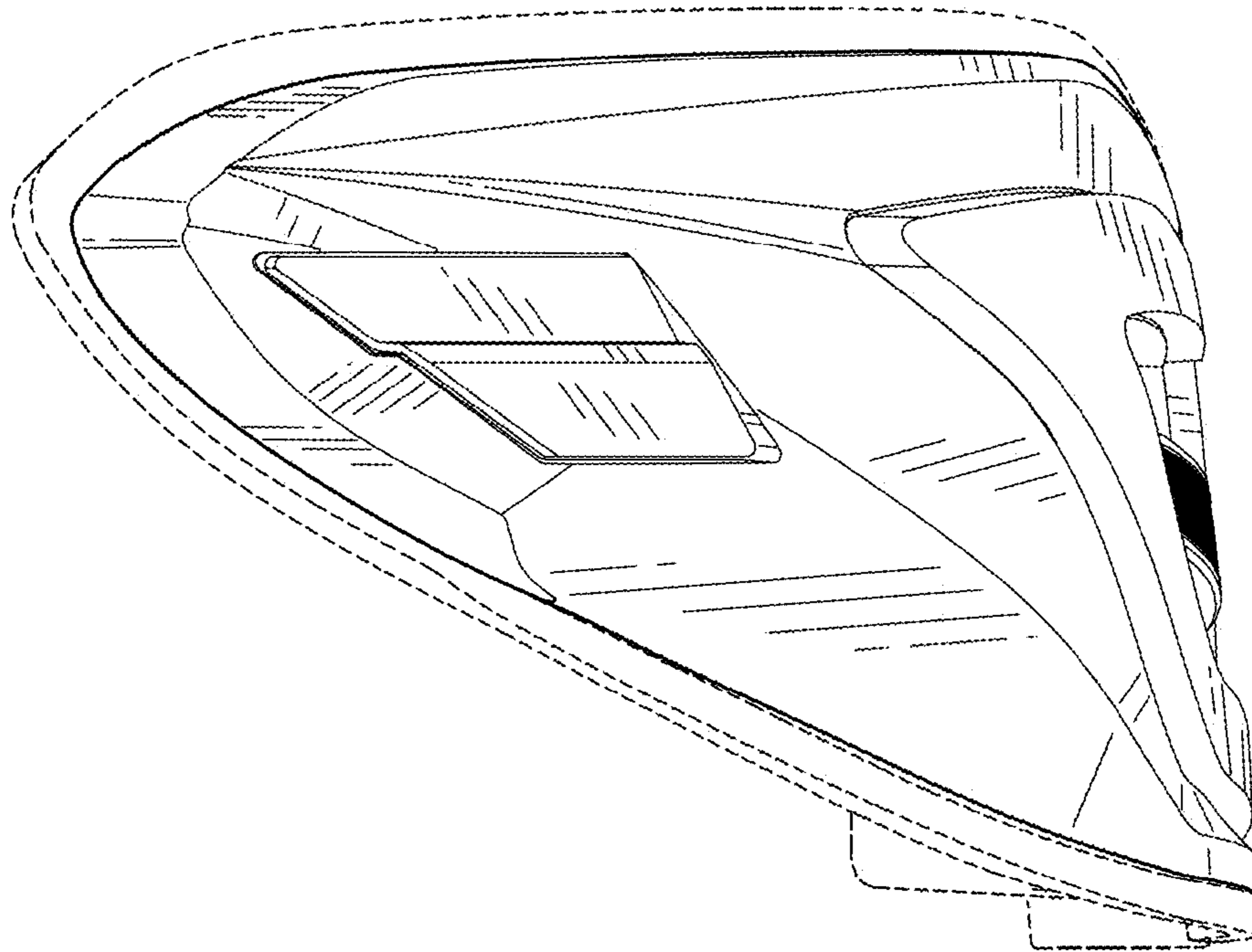

FIG. 4

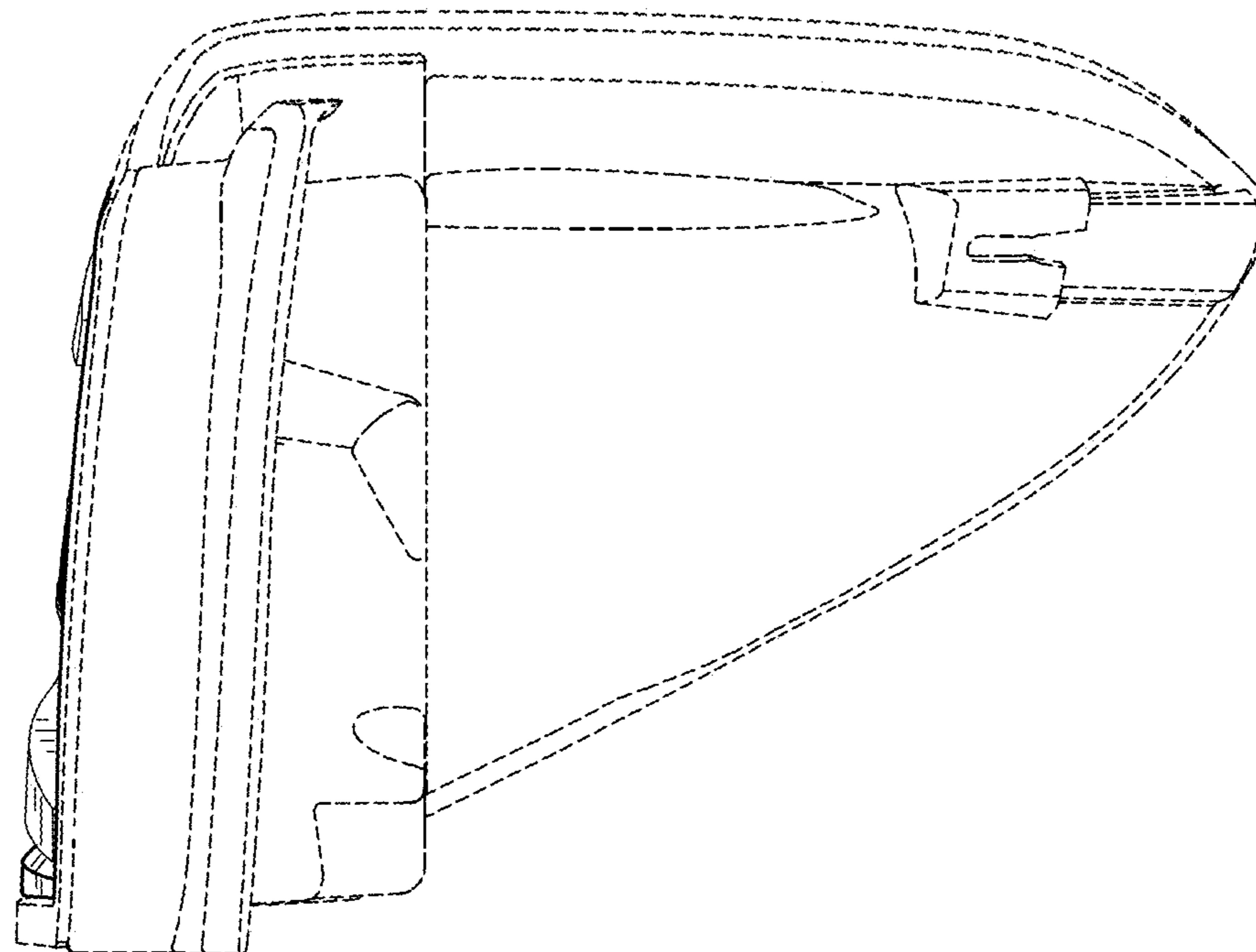

FIG. 5

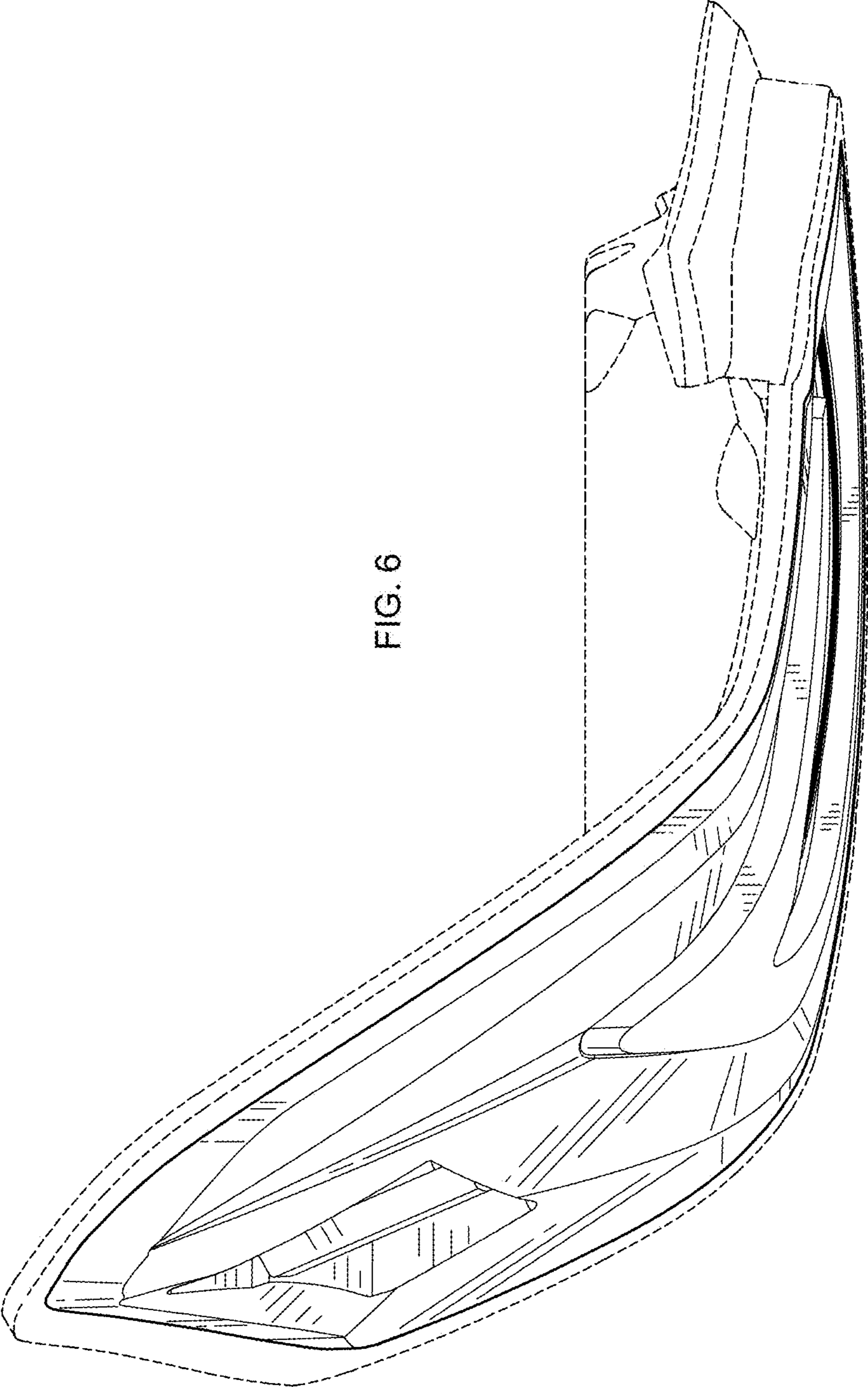

FIG. 6

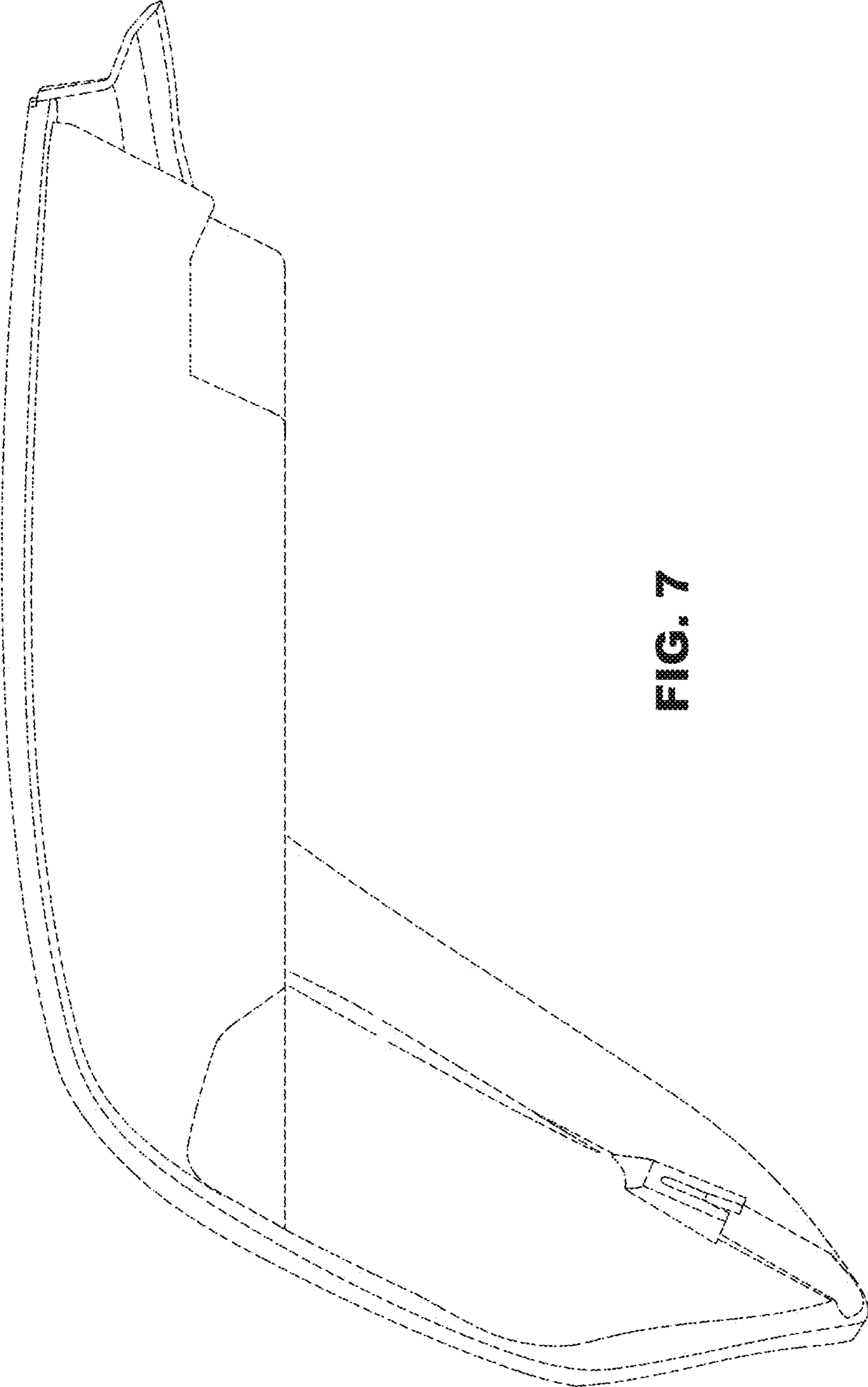

FIG. 7