



US00D888939S

(12) **United States Design Patent**
Fritz et al.

(10) **Patent No.:** **US D888,939 S**
(45) **Date of Patent:** **** Jun. 30, 2020**

- (54) **PEN-SHAPED INJECTOR**
- (71) Applicant: **Sanofi-Aventis Deutschland GmbH**,
Frankfurt am Main (DE)
- (72) Inventors: **Ingo Fritz**, Frankfurt am Main (DE);
Merter Arslan, Frankfurt am Main
(DE)
- (73) Assignee: **Sanofi-Aventis Deutschland GMBH**,
Frankfurt am Main (DE)
- (**) Term: **15 Years**
- (21) Appl. No.: **29/631,102**
- (22) Filed: **Dec. 27, 2017**
- (30) **Foreign Application Priority Data**
Jul. 3, 2017 (EM) 004084382
- (51) **LOC (12) Cl.** **24-02**
- (52) **U.S. Cl.**
USPC **D24/112**
- (58) **Field of Classification Search**
USPC D24/112-114, 108, 133, 130, 127, 186;
606/181, 185; 604/264, 272, 187, 181,
604/184, 227; D19/163-186
CPC A61M 5/178; A61M 3/00; A61M 5/20;
A61M 5/31; A61M 5/3146; A61M
5/3129; A61M 5/3148; A61M 5/315
See application file for complete search history.
- (56) **References Cited**
U.S. PATENT DOCUMENTS
D598,539 S * 8/2009 Tyce D24/113
D599,008 S * 8/2009 Tyce D24/113

- D599,010 S * 8/2009 Tyce D24/113
- D599,011 S * 8/2009 Tyce D24/113
- D606,649 S * 12/2009 Tyce D24/113
- D606,650 S * 12/2009 Tyce D24/113
- D608,442 S * 1/2010 Tyce D24/113
- D610,677 S * 2/2010 Tyce D24/113
- D652,136 S * 1/2012 Hawley D24/113
- D685,464 S * 7/2013 Sanders D24/113
- D697,617 S * 1/2014 Sanders D24/113
- D703,809 S * 4/2014 Sanders D24/113
- D703,810 S * 4/2014 Sanders D24/113

* cited by examiner

Primary Examiner — David G Muller

(74) *Attorney, Agent, or Firm* — Fish & Richardson P.C.

(57) **CLAIM**

The ornamental design for a pen-shaped injector, as shown and described.

DESCRIPTION

The patent or application file contains at least one drawing executed in color. Copies of this patent or patent publication with color drawings(s) will be provided by the Office upon request and payment of the necessary fee.

FIG. 1 is a perspective view of a pen-shaped injection device showing our new design;
FIG. 2 is a front view thereof;
FIG. 3 is a back view thereof;
FIG. 4 is a right side view thereof;
FIG. 5 is a left side view thereof;
FIG. 6 is a bottom view thereof; and,
FIG. 7 is a top view thereof.

The broken line showing of parts of the drawings is included for the purpose of illustrating use and environment and forms no part of the claimed design.

1 Claim, 7 Drawing Sheets
(7 of 7 Drawing Sheet(s) Filed in Color)

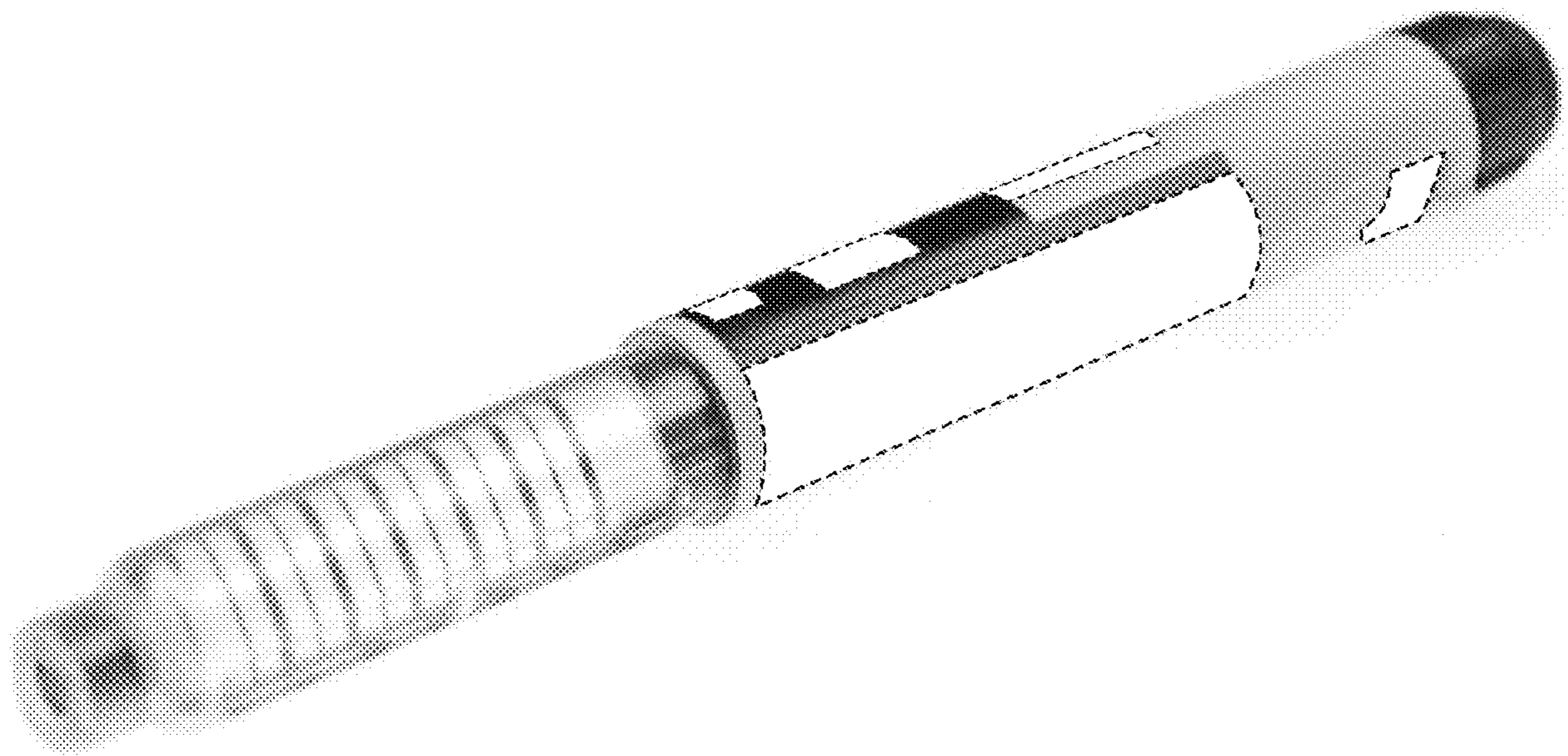

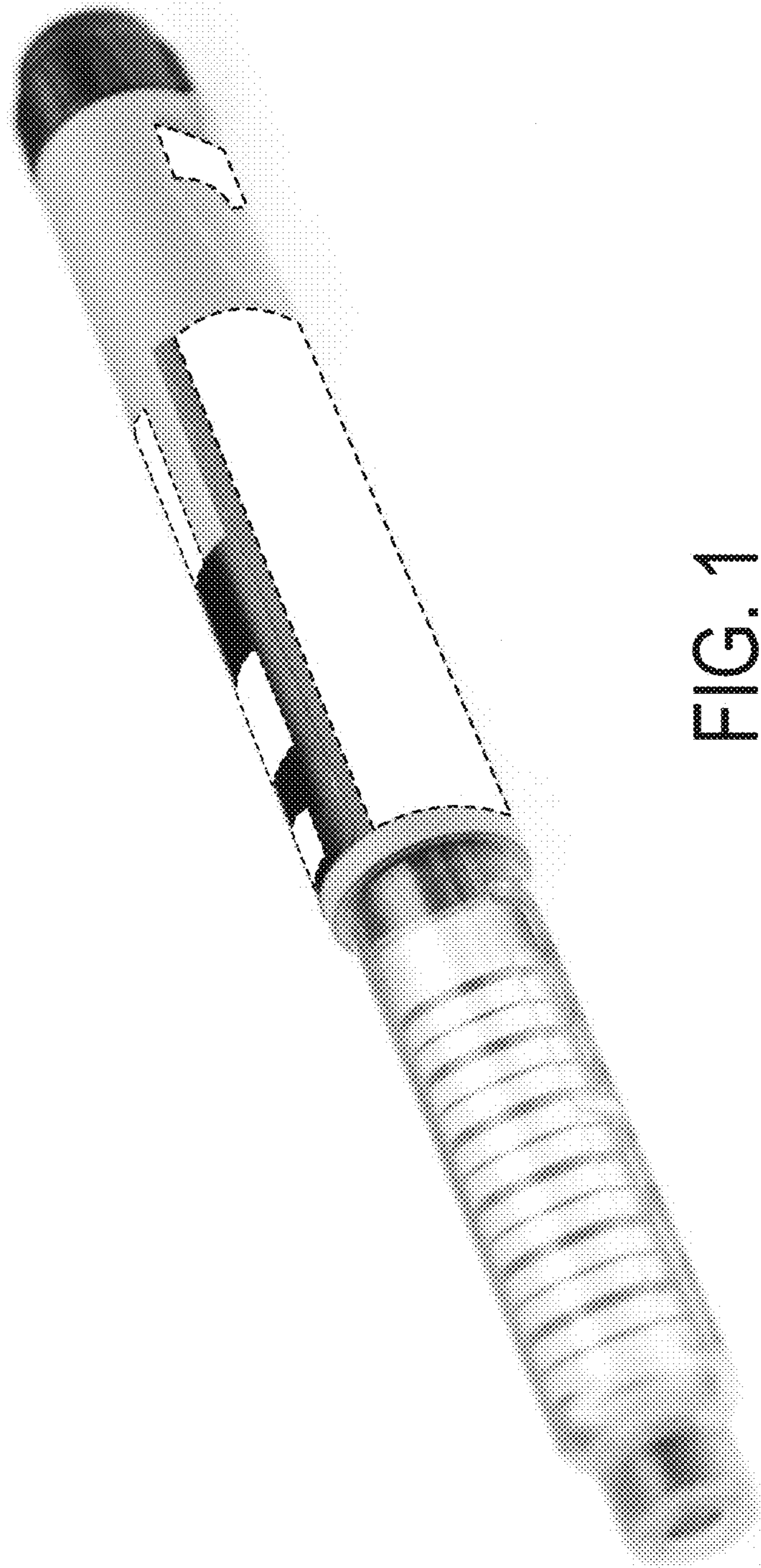

FIG. 1

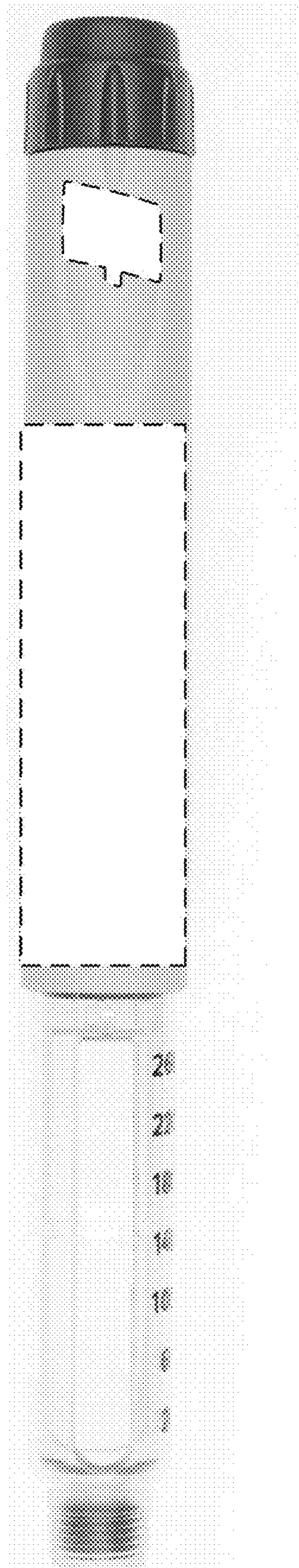

FIG. 2

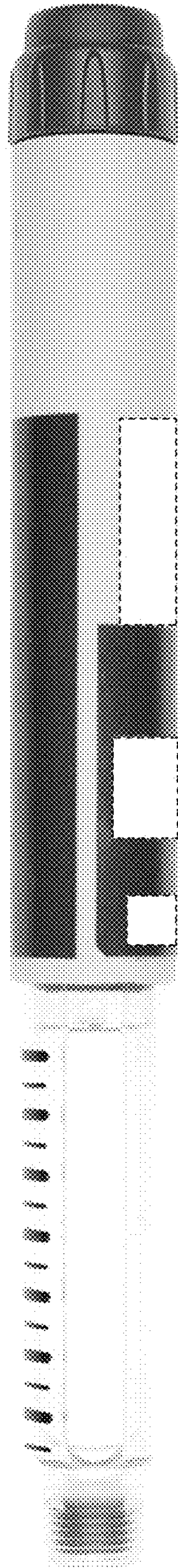

FIG. 3

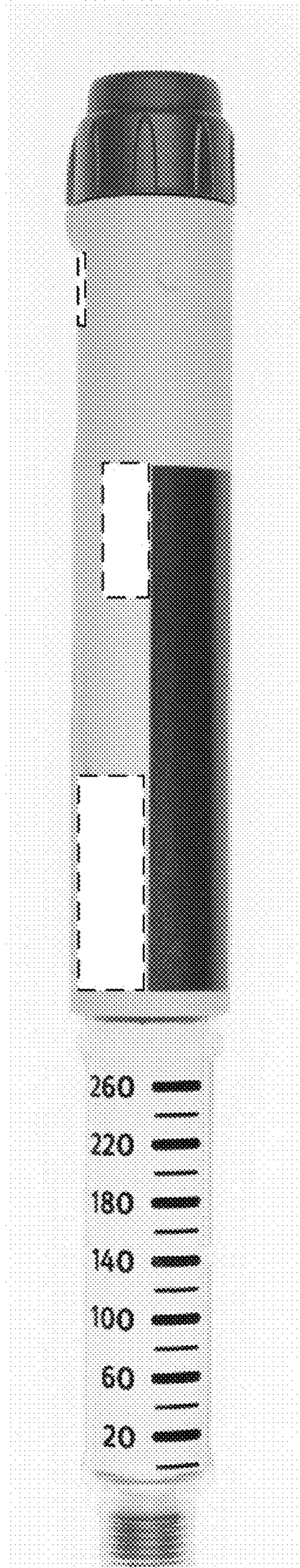

FIG. 4

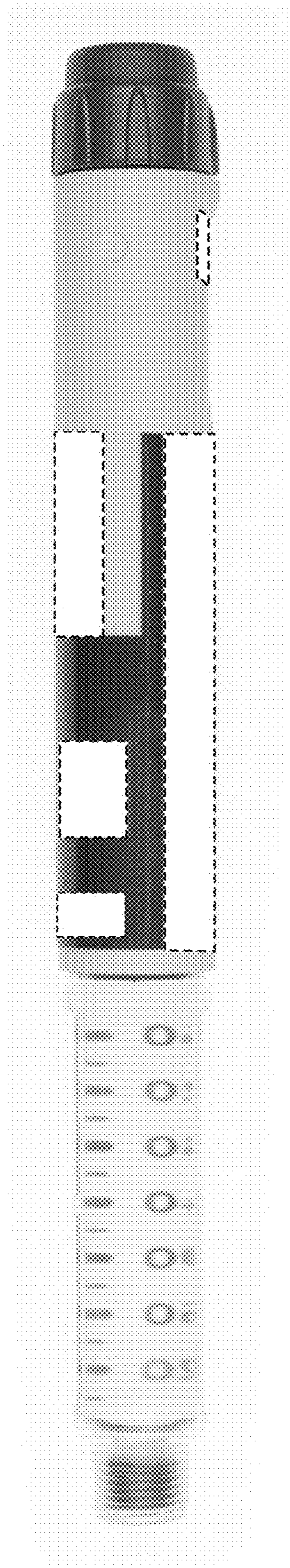

FIG. 5

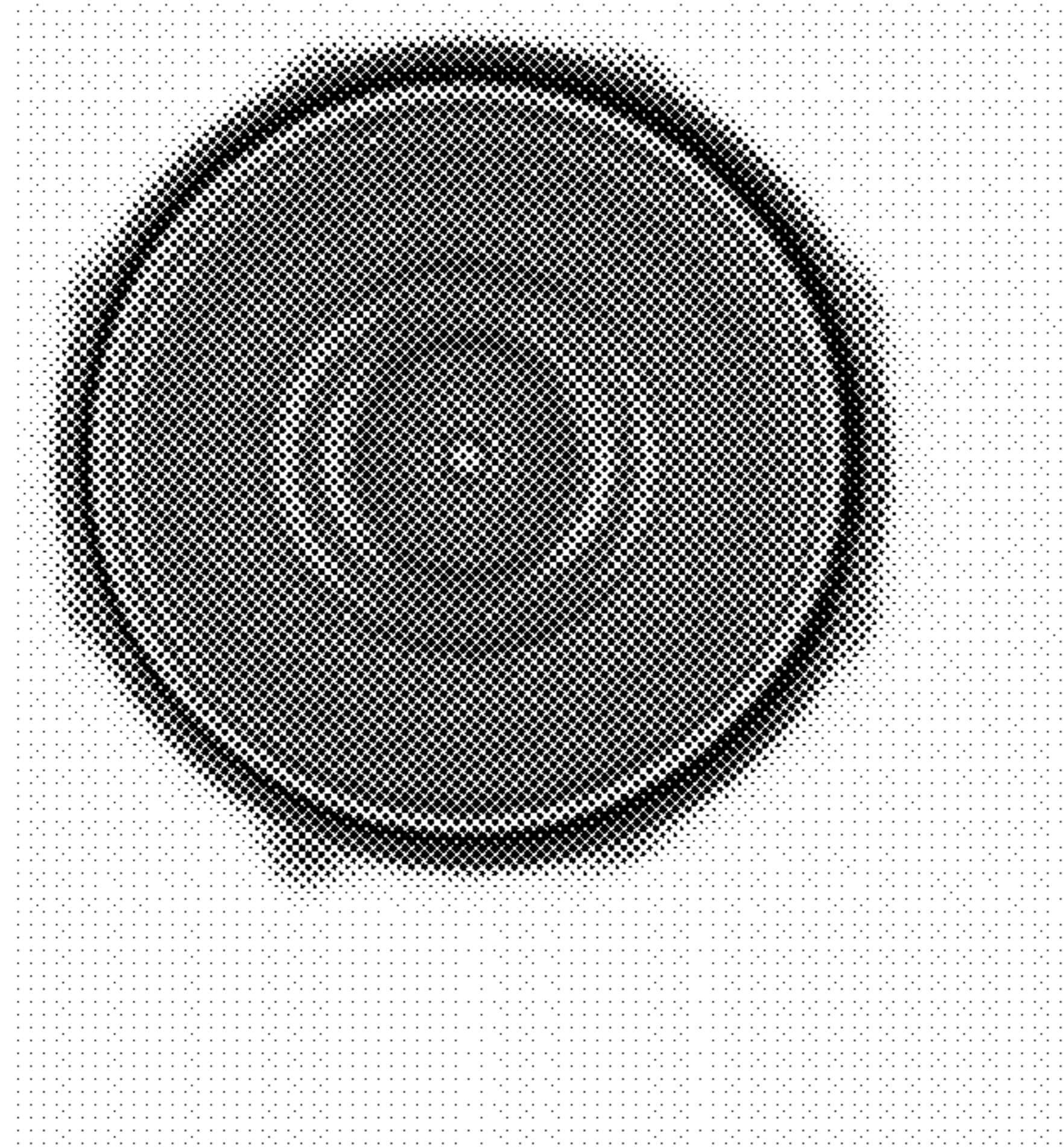

FIG. 6

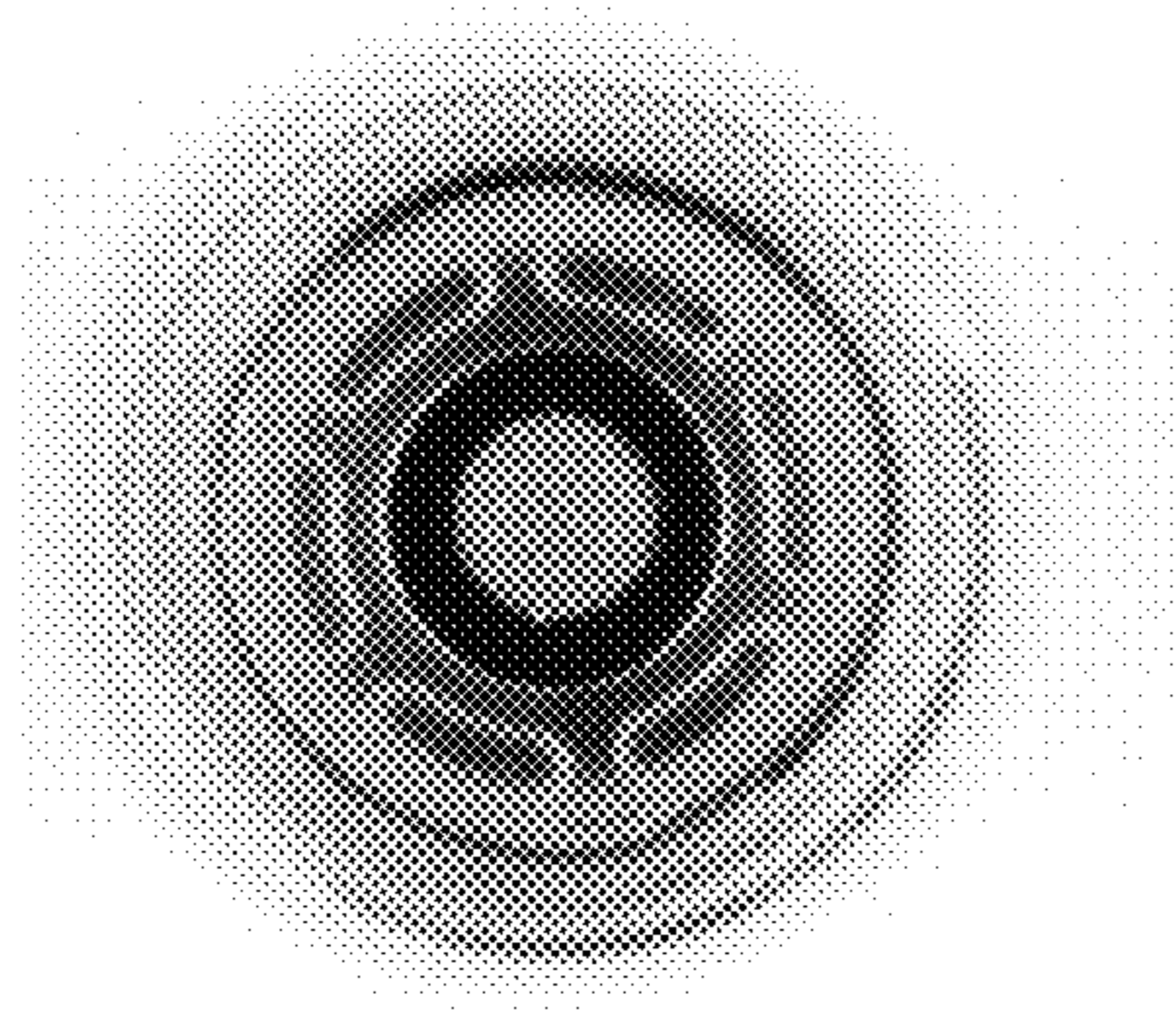

FIG. 7