



US00D888907S

(12) **United States Design Patent**
Kergoët

(10) **Patent No.:** **US D888,907 S**
(45) **Date of Patent:** **** Jun. 30, 2020**

- (54) **WALL HUNG TOILET**
- (71) Applicant: **Kohler Co.**, Kohler, WI (US)
- (72) Inventor: **François Kergoët**, Malakoff (FR)
- (73) Assignee: **KOHLER CO.**, Kohler, WI (US)
- (**) Term: **15 Years**
- (21) Appl. No.: **29/645,840**
- (22) Filed: **Apr. 30, 2018**
- (51) **LOC (12) Cl.** **23-02**
- (52) **U.S. Cl.**
USPC **D23/300**; D23/309
- (58) **Field of Classification Search**
USPC D23/295–301, 303, 309, 311–313
CPC A47K 11/02; A47K 11/026; A47K 11/00;
A47K 13/00; E03D 11/18; E03D 5/10;
E03D 13/00
See application file for complete search history.

(56) **References Cited**

U.S. PATENT DOCUMENTS

D443,346 S	*	6/2001	Kawamura	D23/295
D465,562 S	*	11/2002	Moore	D23/295
D523,541 S		6/2006	Soulier		
D621,487 S	*	8/2010	Toyohara	D23/300
D639,406 S		6/2011	Bickerstaffe et al.		
D693,910 S		11/2013	Bates et al.		
D693,912 S		11/2013	Fullerton, Jr. et al.		
D701,949 S		4/2014	Bates et al.		
D703,796 S		4/2014	McKeone et al.		
D703,797 S	*	4/2014	Shinozaki	D23/300

(Continued)

OTHER PUBLICATIONS

Kohler 2016 Fixtures Price book pp. 314-347.

Primary Examiner — Brandon M Rosati
Assistant Examiner — John A Voytek
(74) *Attorney, Agent, or Firm* — Foley & Lardner LLP

(57) **CLAIM**

I claim the ornamental design for a wall hung toilet, as shown and described.

DESCRIPTION

FIG. 1 is a perspective view of an embodiment of the claimed design;
 FIG. 2 is a front view of the claimed design shown in FIG. 1;
 FIG. 3 is a rear view of the claimed design shown in FIG. 1;
 FIG. 4 is a top view of the claimed design shown in FIG. 1;
 FIG. 5 is a bottom view of the claimed design shown in FIG. 1;
 FIG. 6 is a side view of the claimed design shown in FIG. 1;
 FIG. 7 is a side view of the claimed design shown in FIG. 1;
 FIG. 8 is a perspective view of another embodiment of the claimed design;
 FIG. 9 is a front view of the claimed design shown in FIG. 8;
 FIG. 10 is a rear view of the claimed design shown in FIG. 8;
 FIG. 11 is a top view of the claimed design shown in FIG. 8;
 FIG. 12 is a bottom view of the claimed design shown in FIG. 8;
 FIG. 13 is a side view of the claimed design shown in FIG. 8; and,
 FIG. 14 is a side view of the claimed design shown in FIG. 8.

In the drawings, the broken lines depict unclaimed portions of the wall hung toilet. The dot and dashed lines represent a boundary between the claimed and the non-claimed portions and form no part of the claimed design.

1 Claim, 14 Drawing Sheets

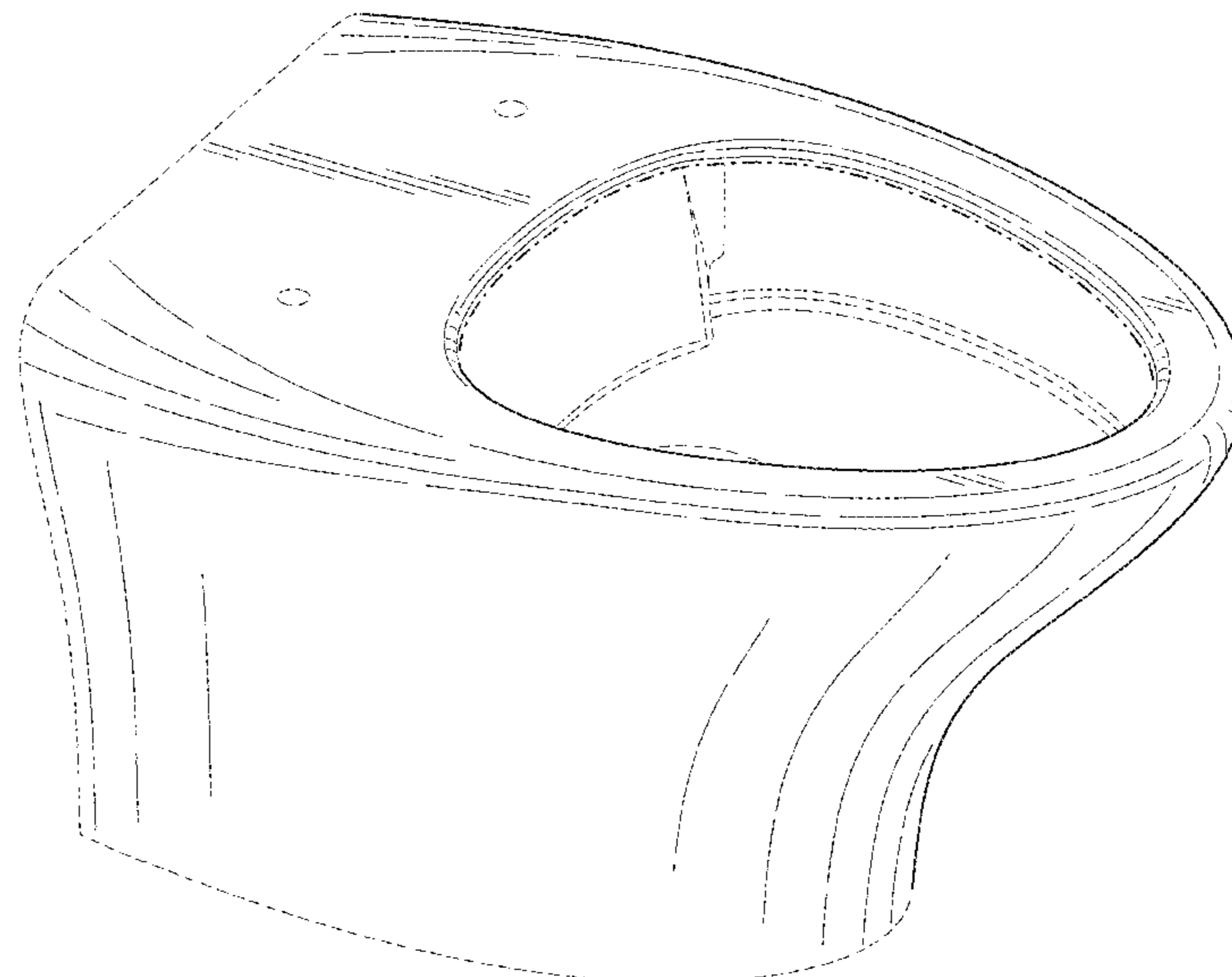

(56)

References Cited

U.S. PATENT DOCUMENTS

D767,742 S *	9/2016	Bates	D23/309
D801,493 S *	10/2017	Bates	D23/309
D811,562 S *	2/2018	Snyder	D23/295
D844,118 S *	3/2019	Jeong	D23/295
2006/0112478 A1 *	6/2006	Kolar	E03D 5/01
				4/300

* cited by examiner

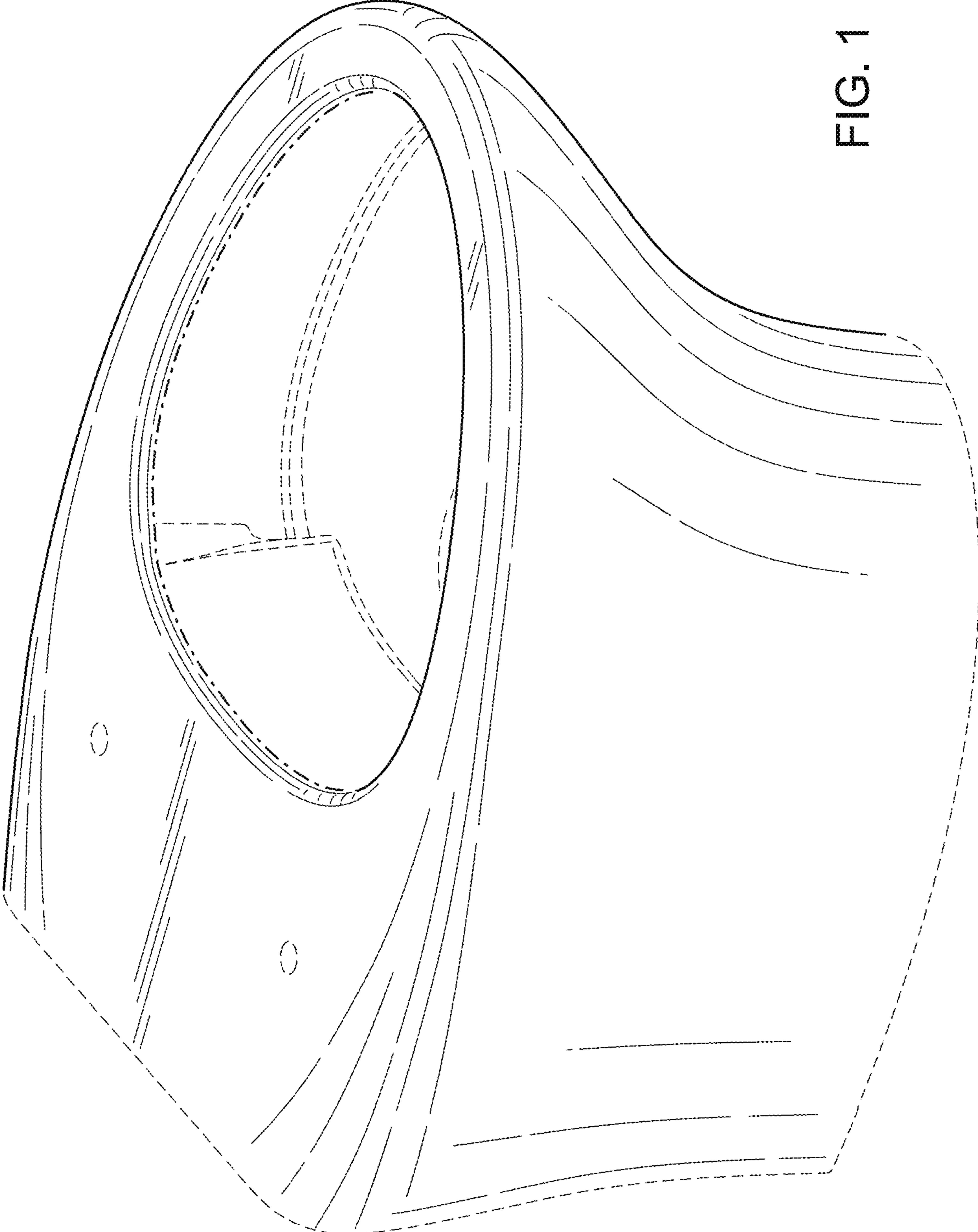

FIG. 1

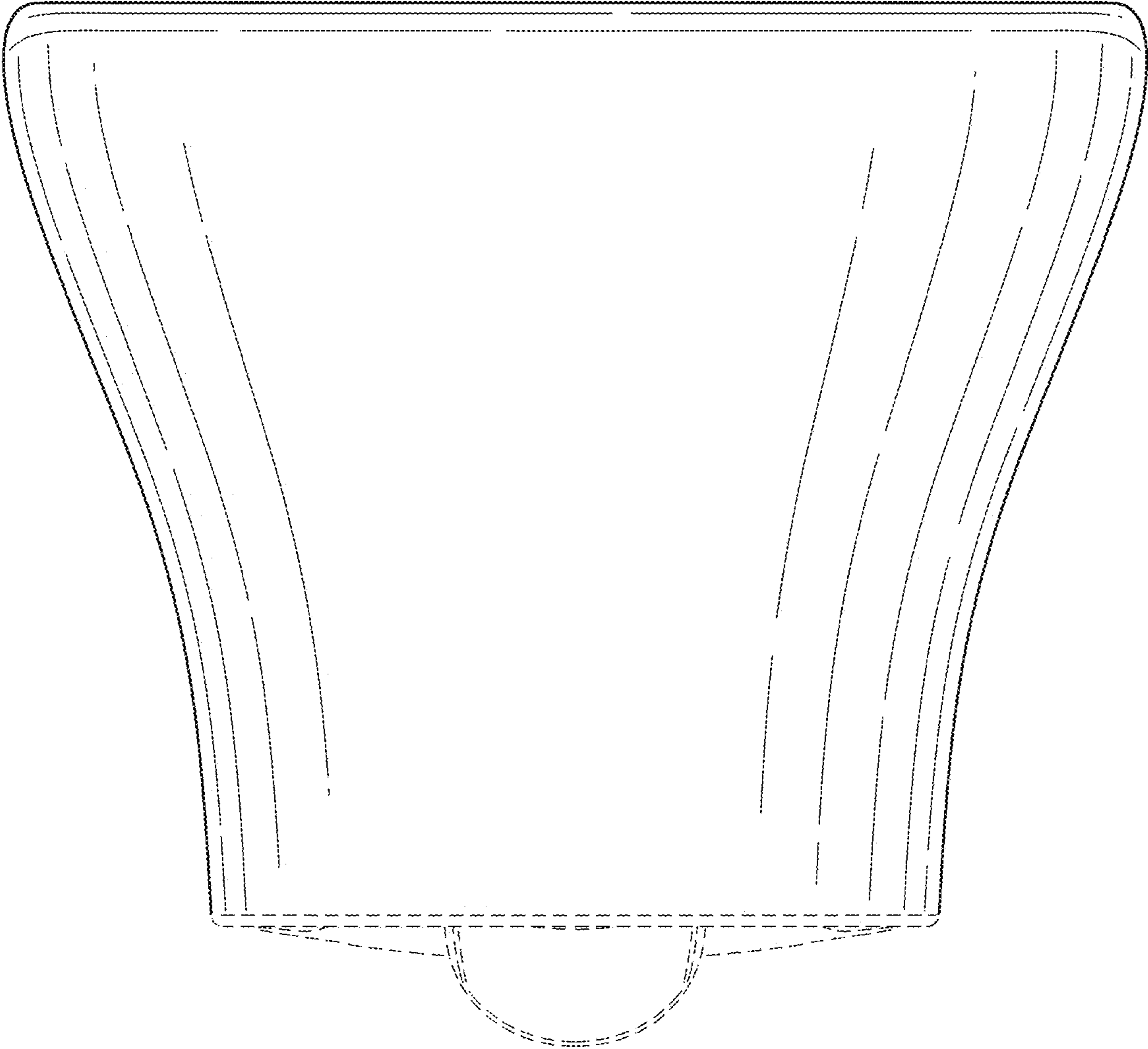

FIG. 2

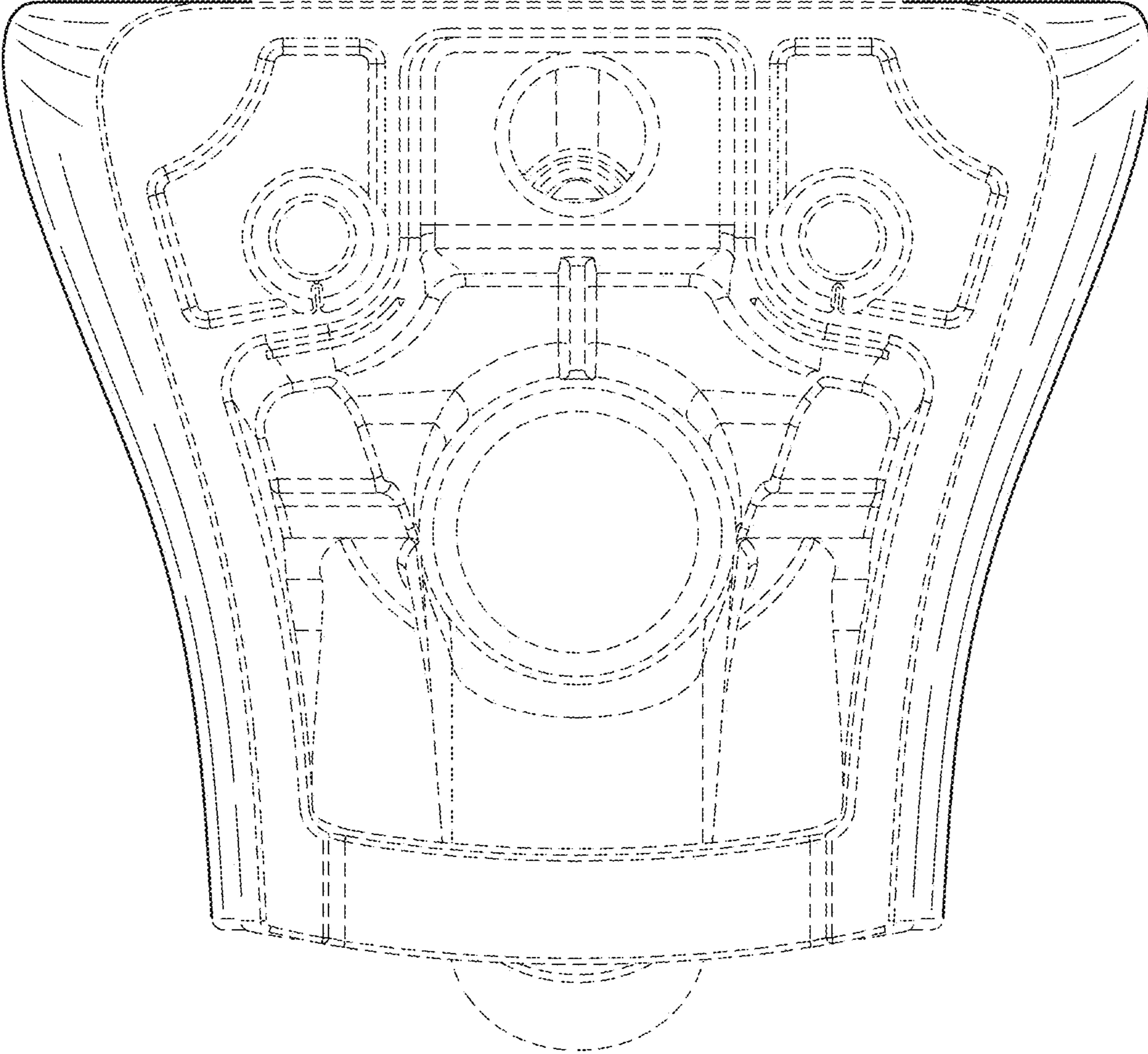

FIG. 3

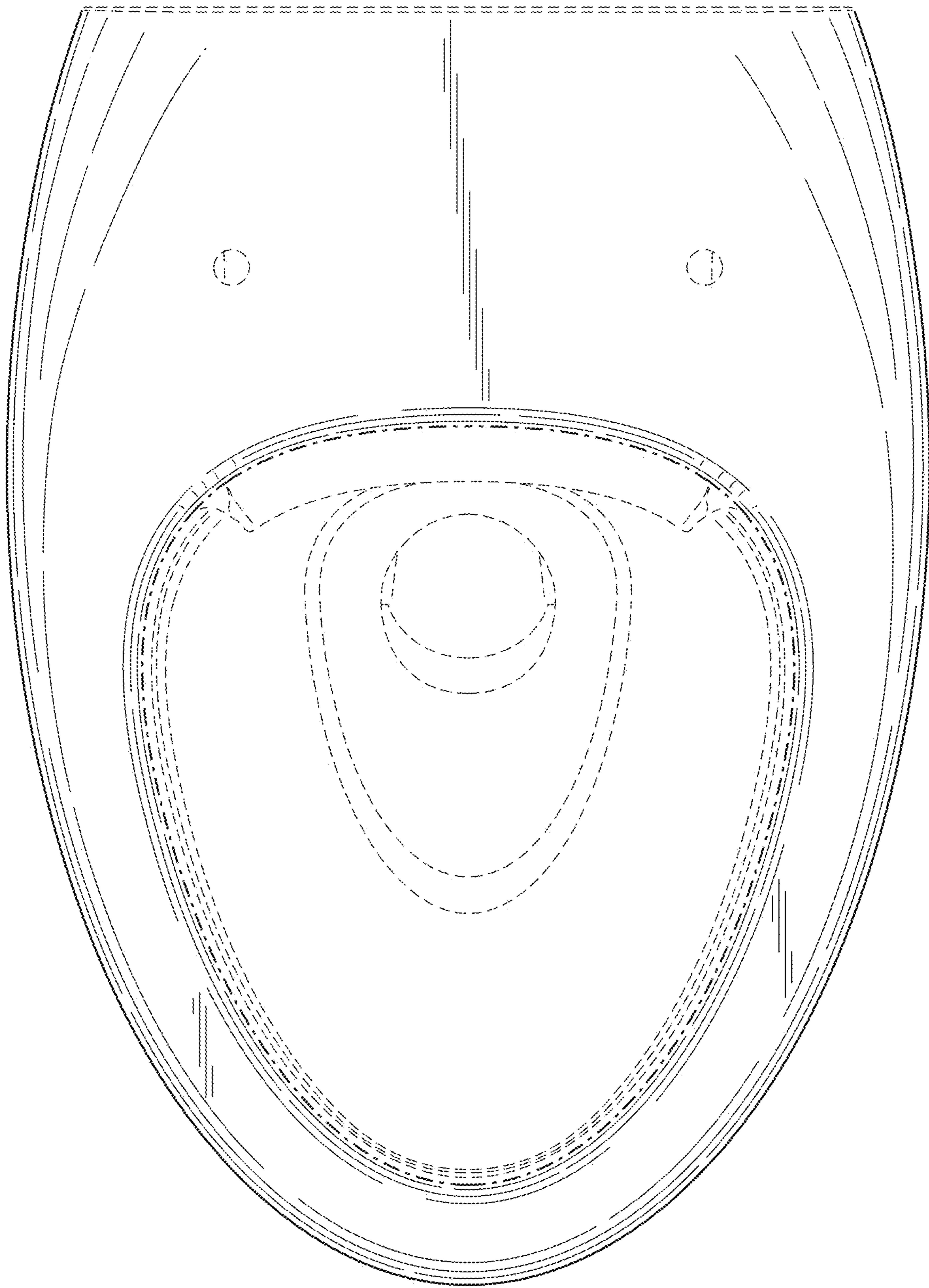

FIG. 4

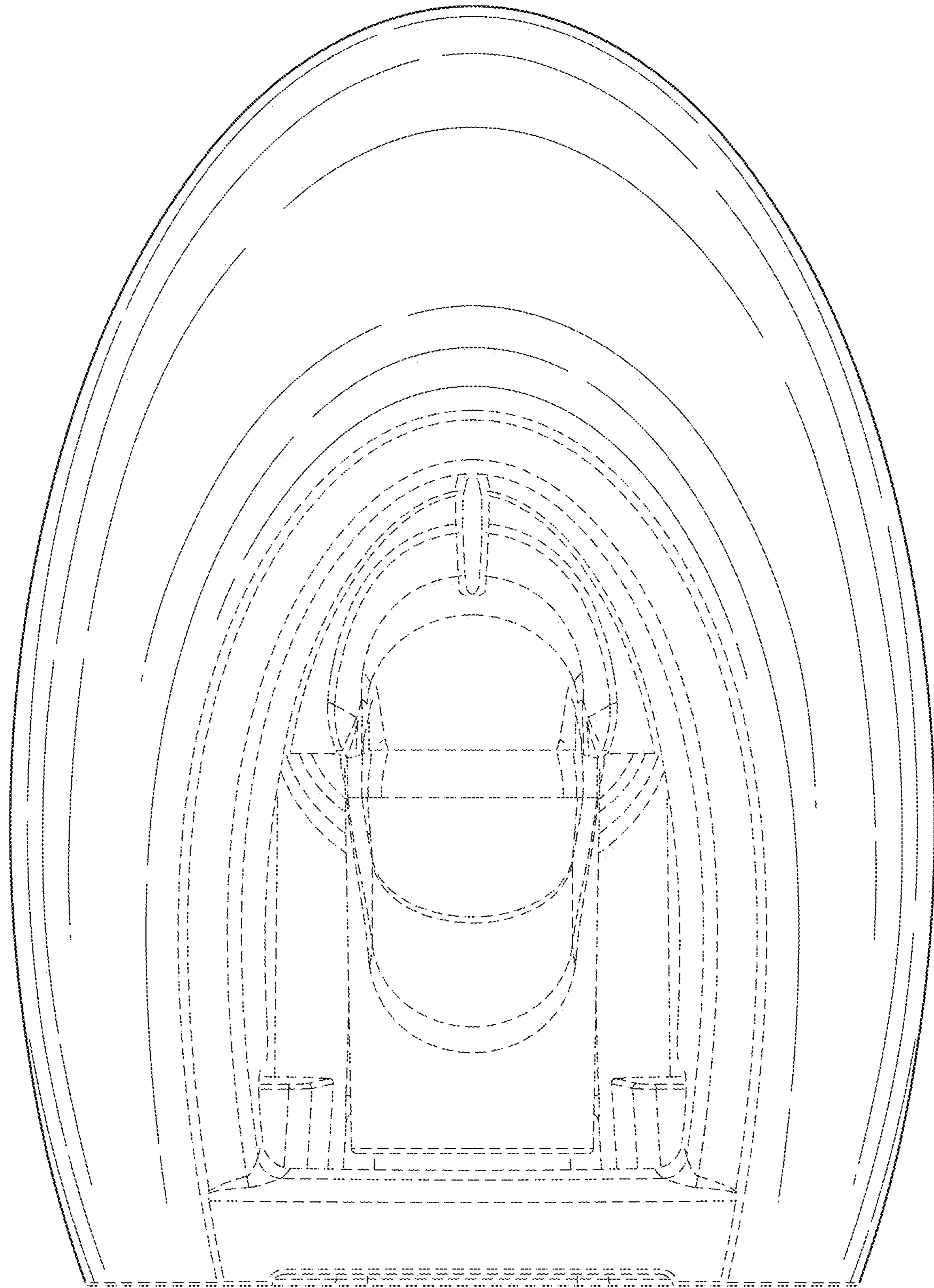

FIG. 5

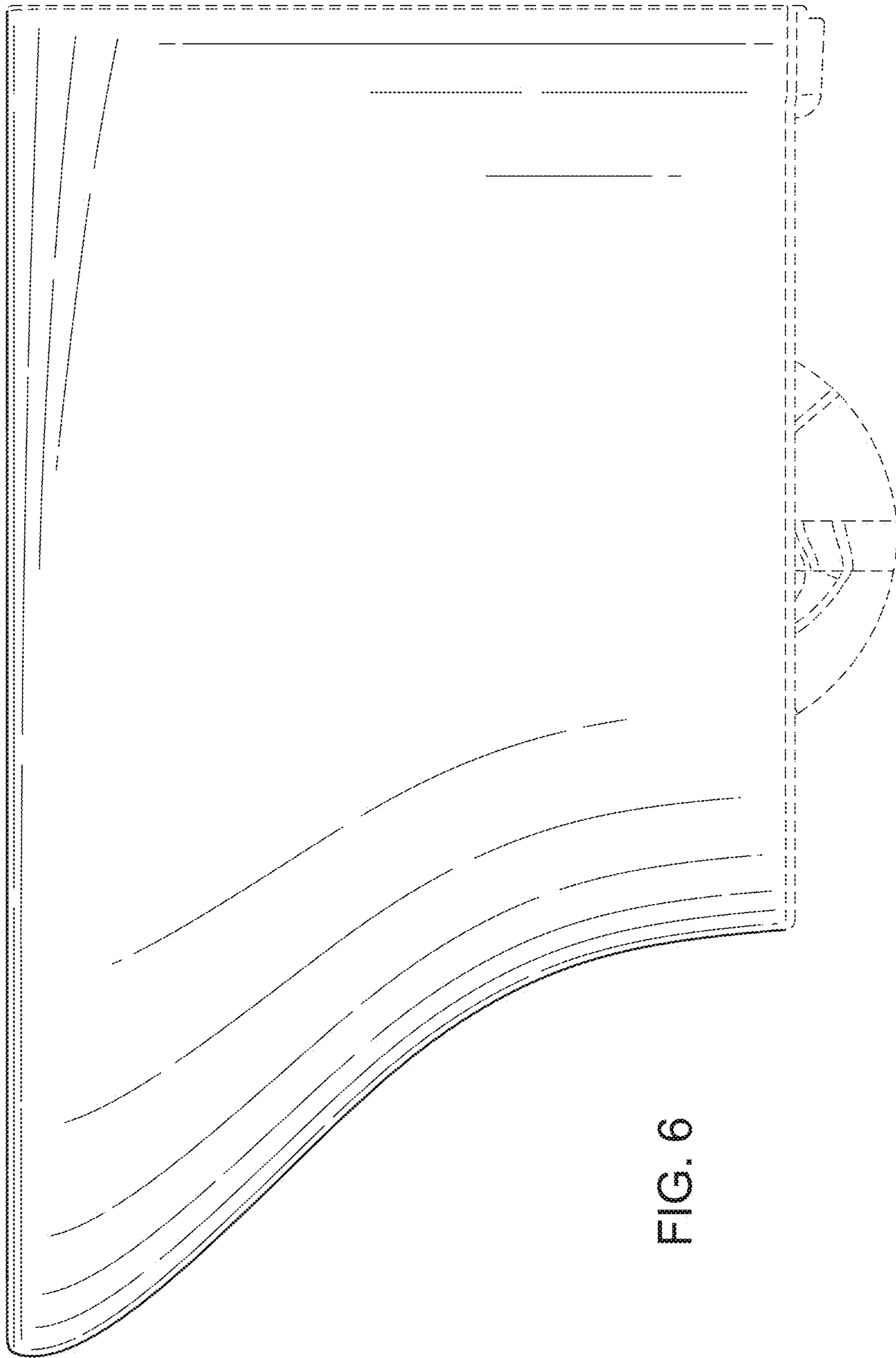

FIG. 6

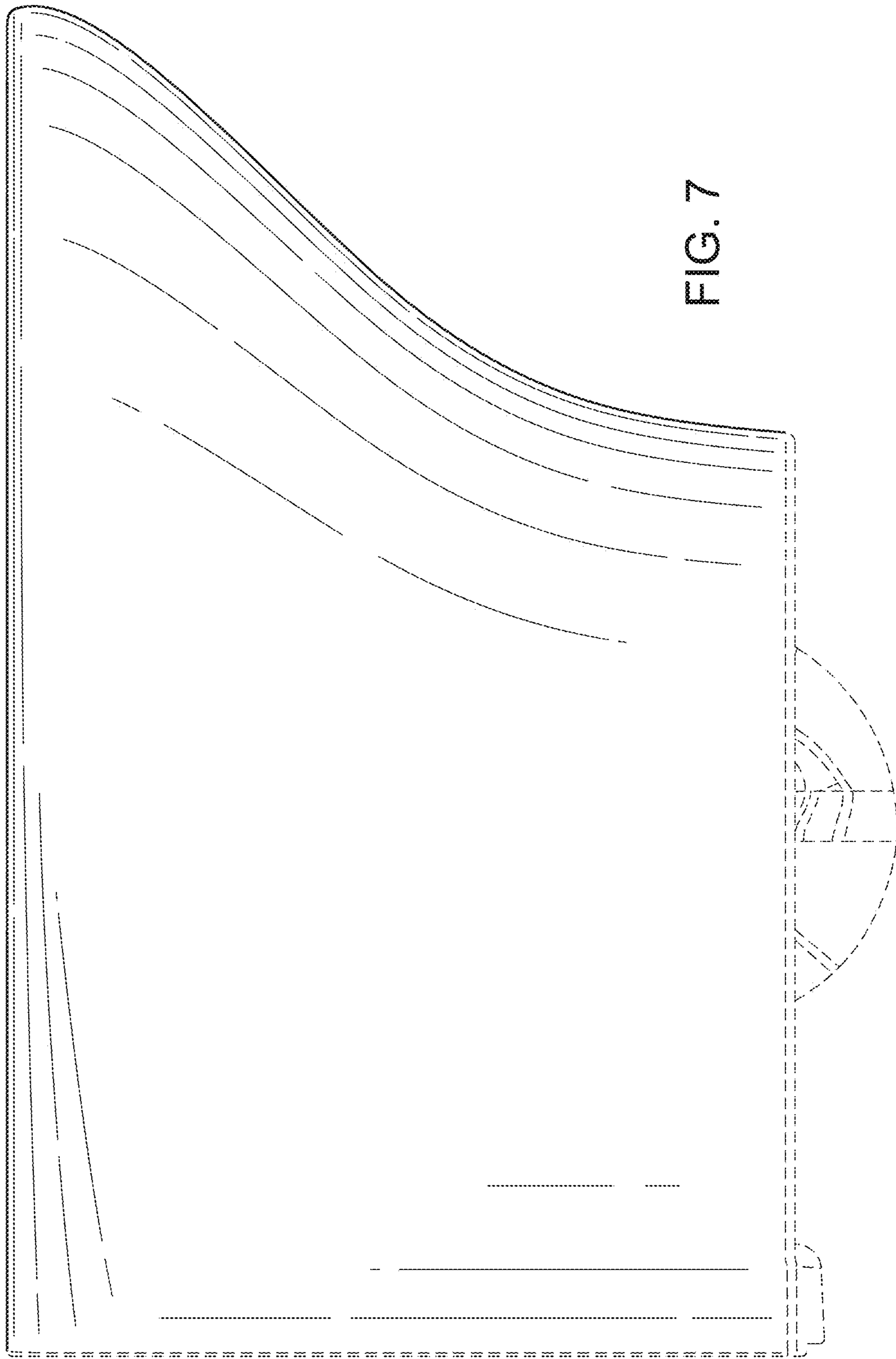

FIG. 7

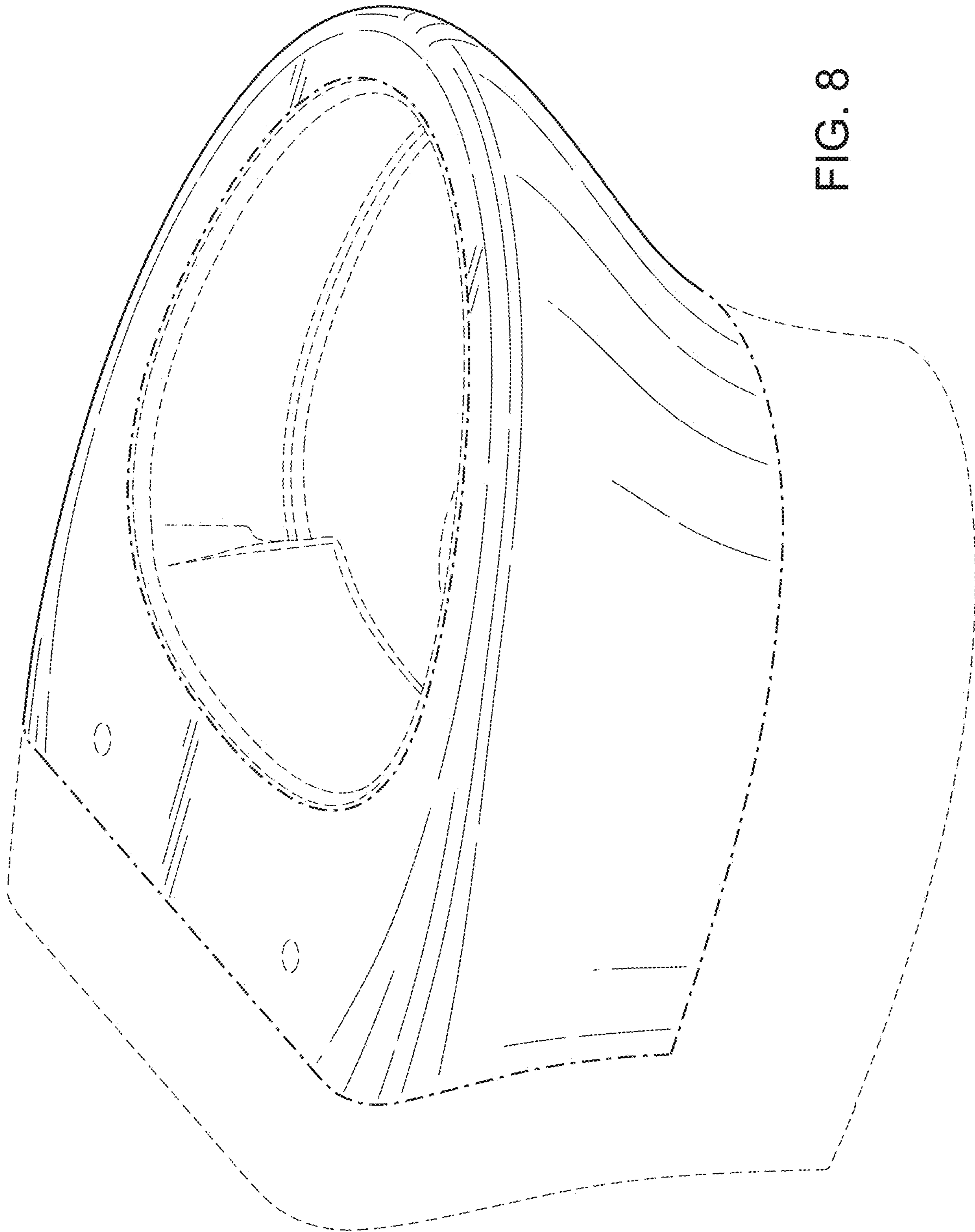

FIG. 8

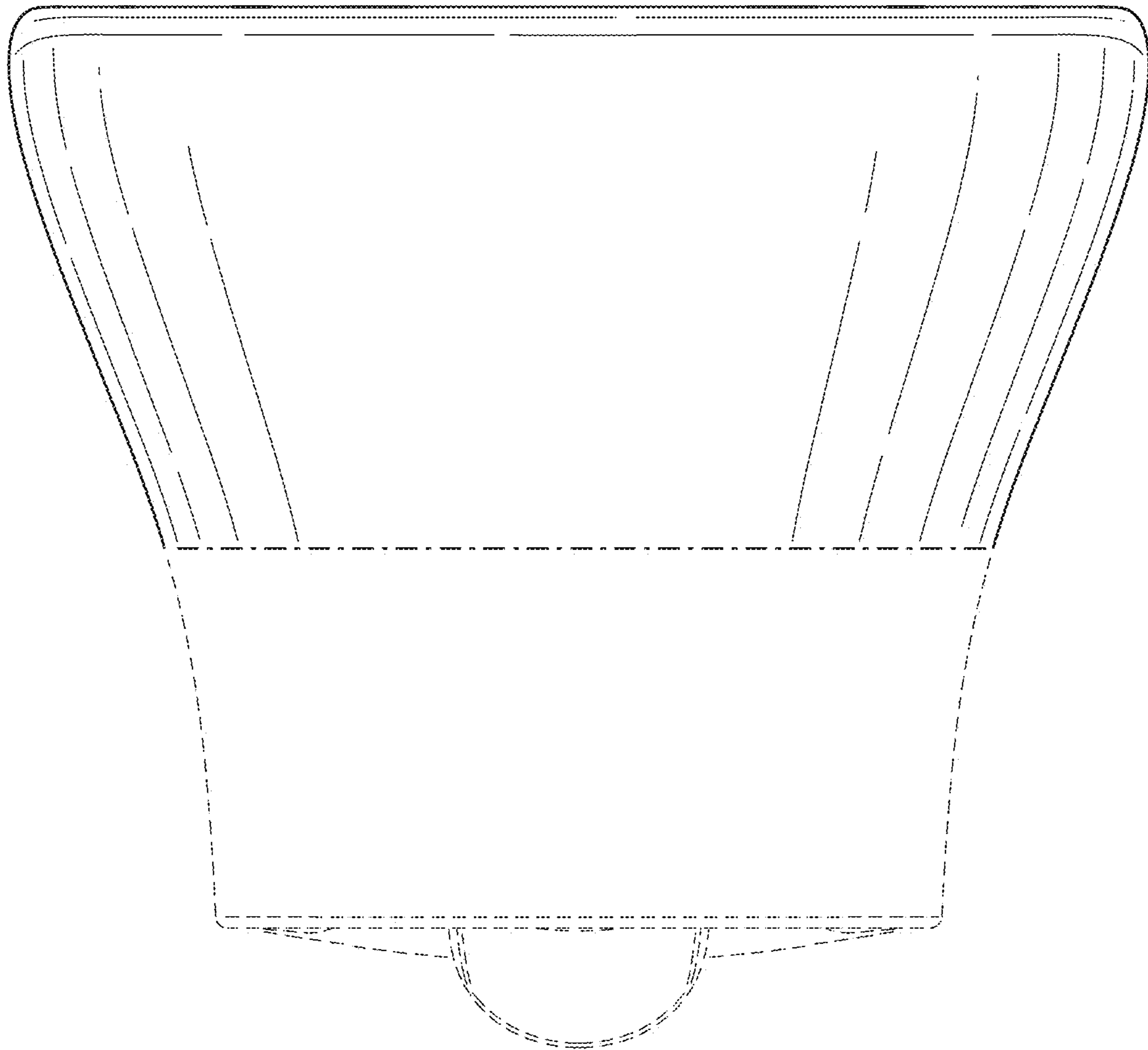

FIG. 9

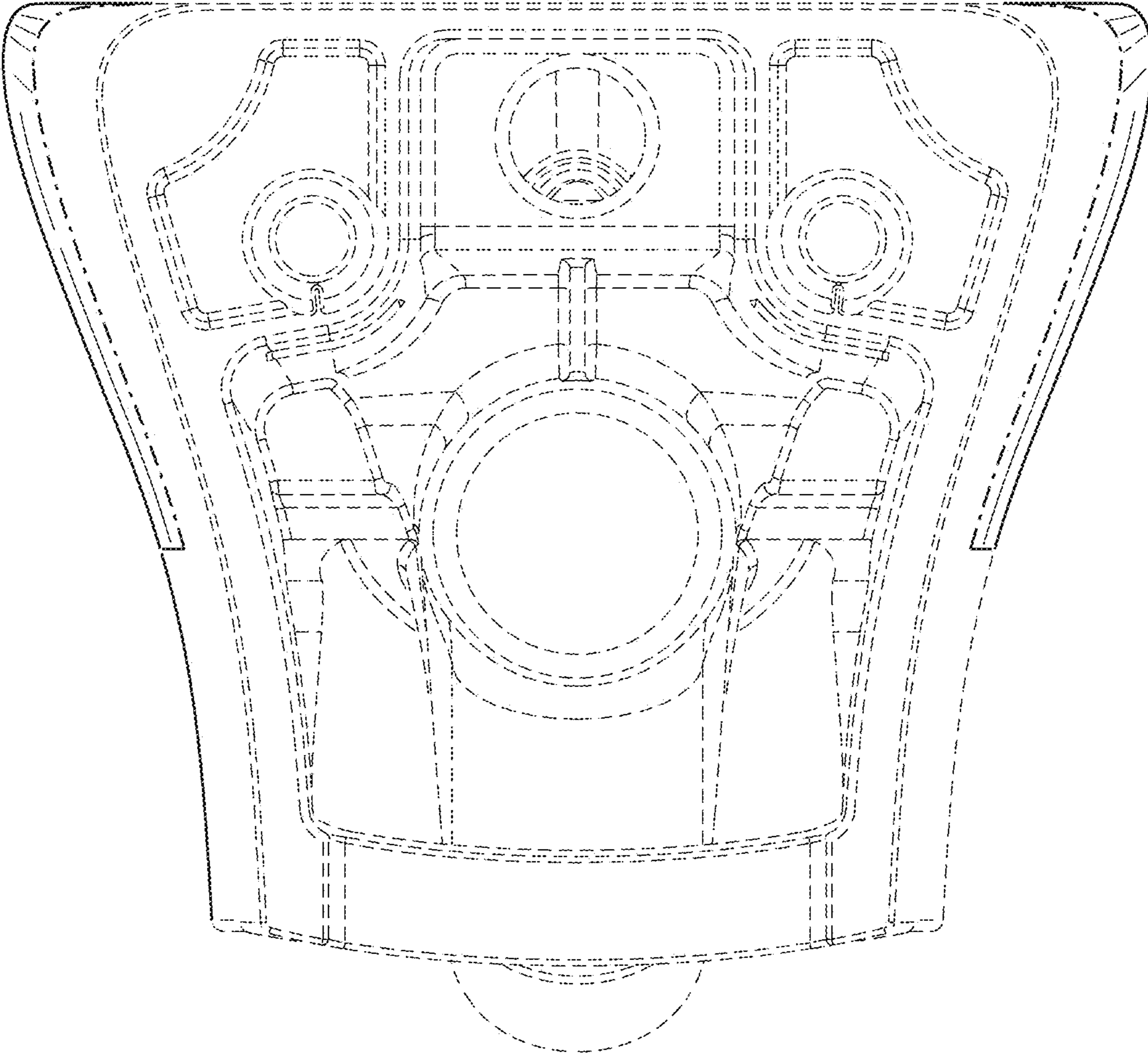

FIG. 10

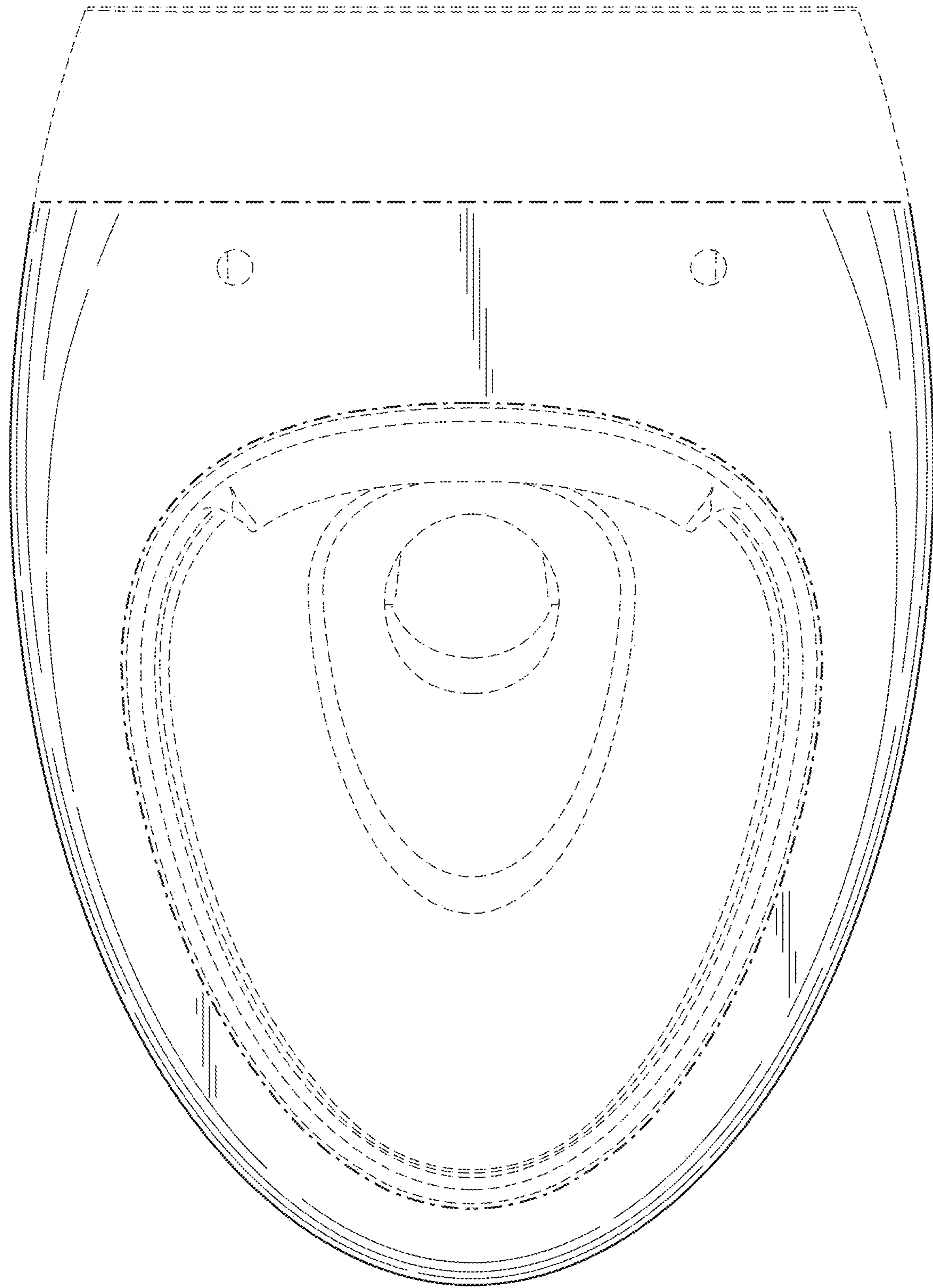

FIG. 11

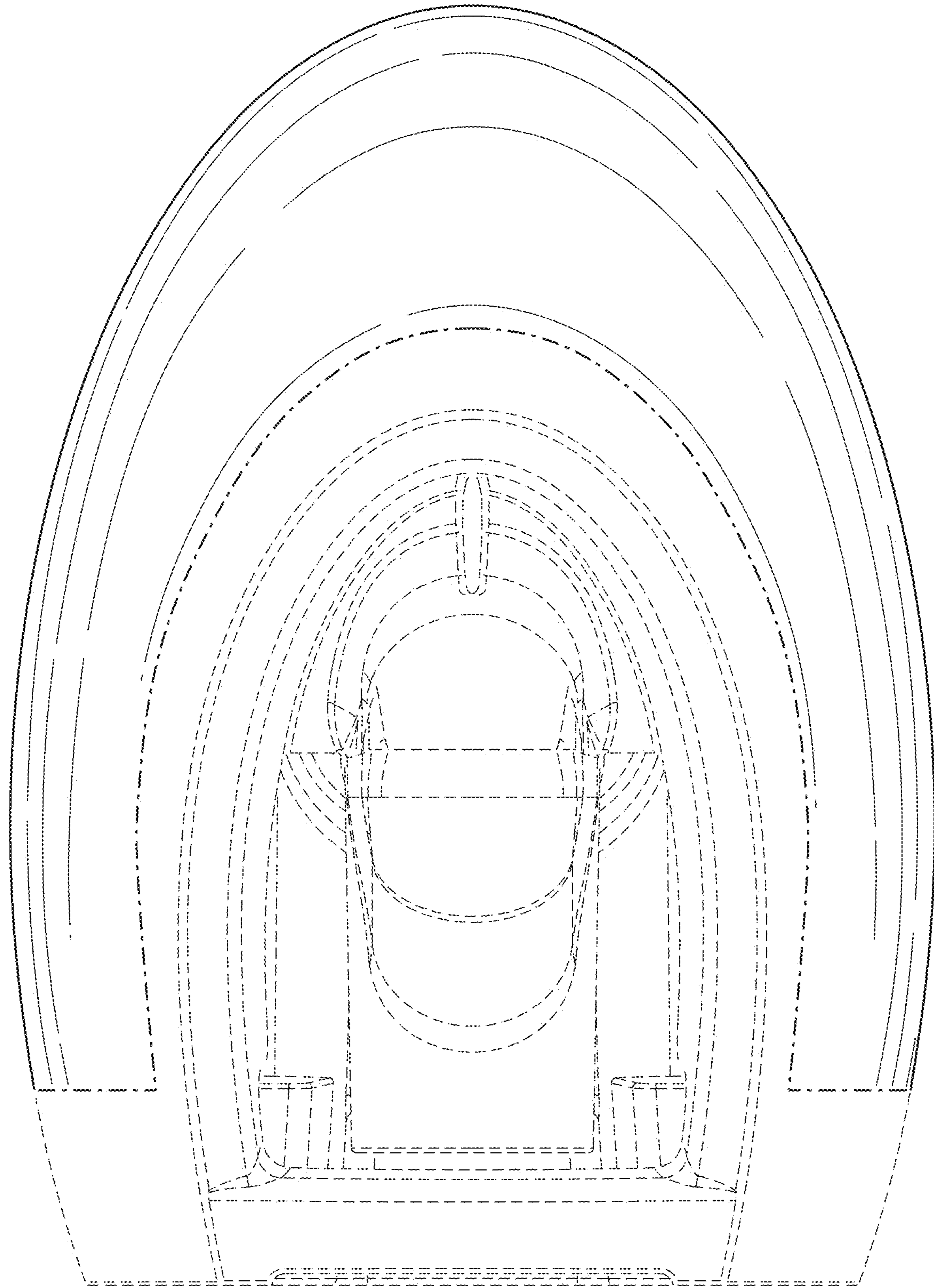

FIG. 12

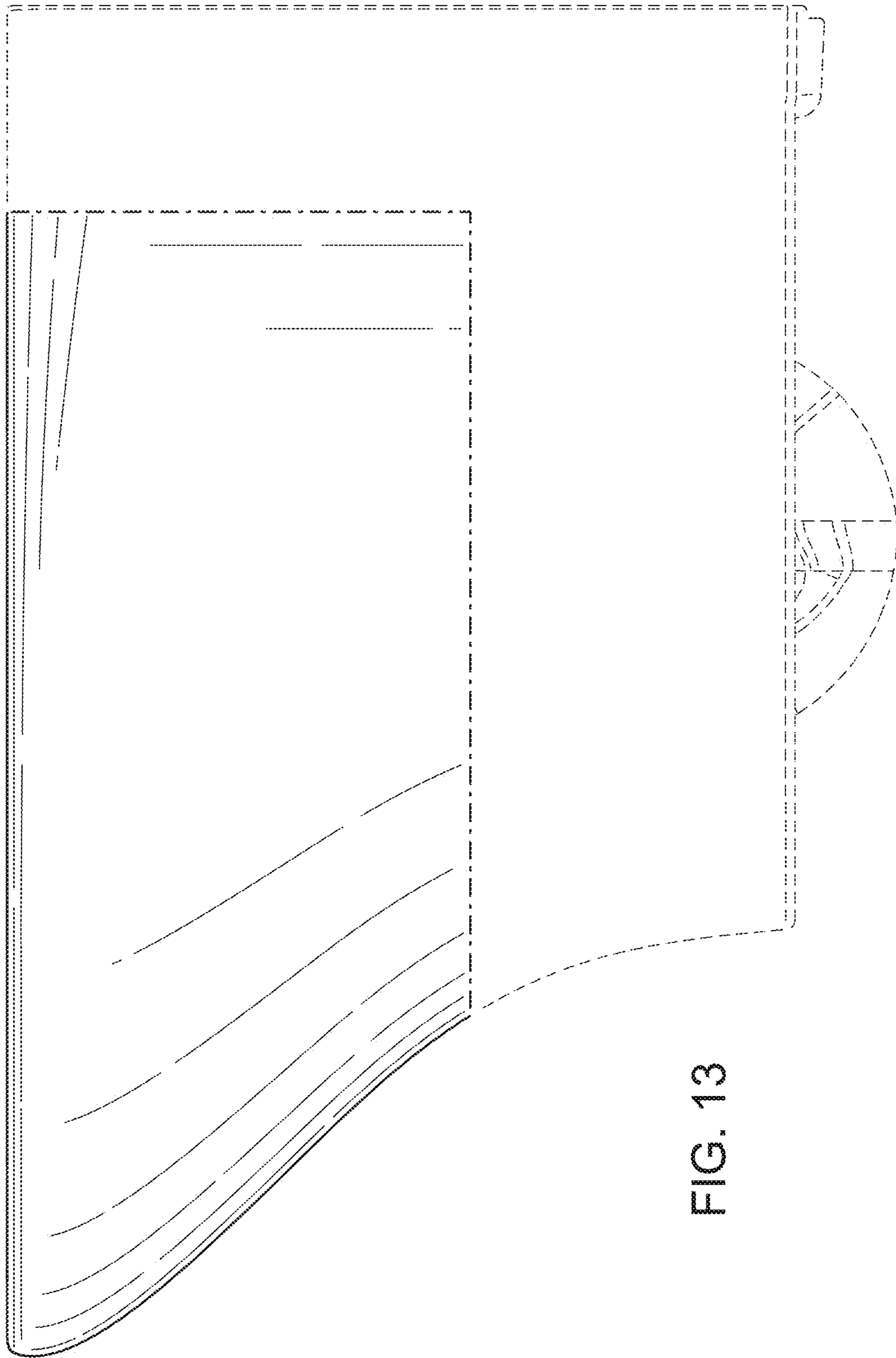

FIG. 13

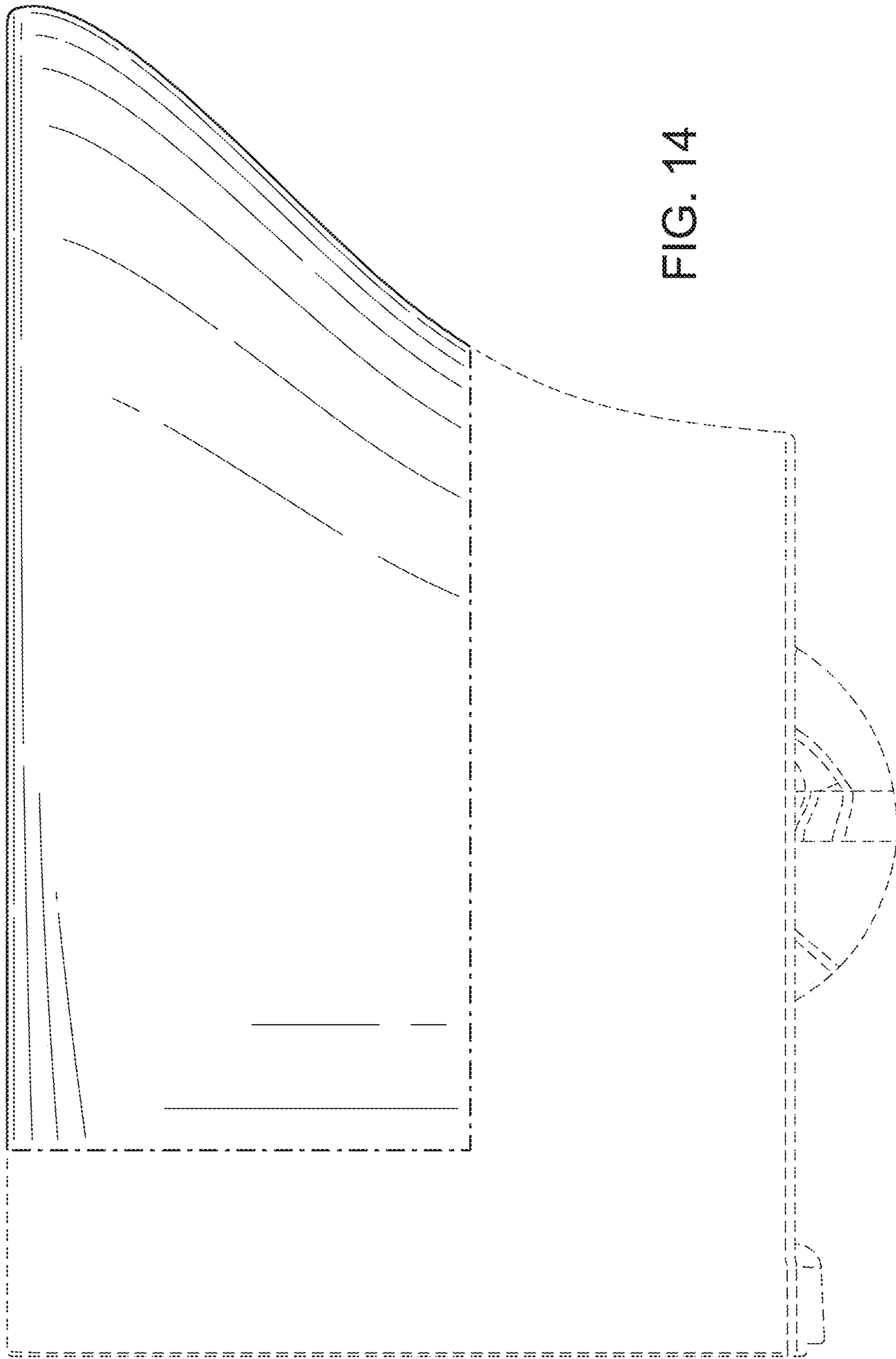

FIG. 14