



US00D888881S

(12) **United States Design Patent**
Toris

(10) **Patent No.:** **US D888,881 S**

(45) **Date of Patent:** **** Jun. 30, 2020**

(54) **FISHING LURE**

(71) Applicant: **Georgios G. Toris**, Gavle (SE)

(72) Inventor: **Georgios G. Toris**, Gavle (SE)

(**) Term: **15 Years**

(21) Appl. No.: **29/666,174**

(22) Filed: **Oct. 10, 2018**

(51) **LOC (12) Cl.** **22-05**

(52) **U.S. Cl.**
USPC **D22/133**

(58) **Field of Classification Search**
USPC D22/126, 130, 133–134; 43/42.33, 42.32,
43/42.45, 42.5, 42.51, 42.37, 42, 42.39,
43/42.44
CPC A01K 85/00; A01K 85/16
See application file for complete search history.

(56) **References Cited**

U.S. PATENT DOCUMENTS

- 3,360,882 A * 1/1968 Belokin, Jr. A01K 85/16
43/42.33
- D225,008 S * 10/1972 Cordell, Jr. D22/133

- D354,541 S * 1/1995 Rogers D22/131
- D454,172 S * 3/2002 Barefoot D22/133
- D466,965 S * 12/2002 Toris D22/131

* cited by examiner

Primary Examiner — Catherine R Oliver-Garcia
(74) *Attorney, Agent, or Firm* — Glenn E. Gold, P.A.;
Glenn E. Gold

(57) **CLAIM**

I claim the ornamental design for a fishing lure, as shown and described.

DESCRIPTION

FIG. 1 is an isometric front, top left side view of a fishing lure;
FIG. 2 is a right side elevation view thereof;
FIG. 3 is a left side elevation view thereof;
FIG. 4 is a rear view thereof;
FIG. 5 is a front view thereof;
FIG. 6 is a bottom view thereof; and,
FIG. 7 is a right elevation view thereof with a bottom side fish hook attached.
The broken lines depict environmental structure and are included for purposes of illustration only and form no part of the claimed design.

1 Claim, 7 Drawing Sheets

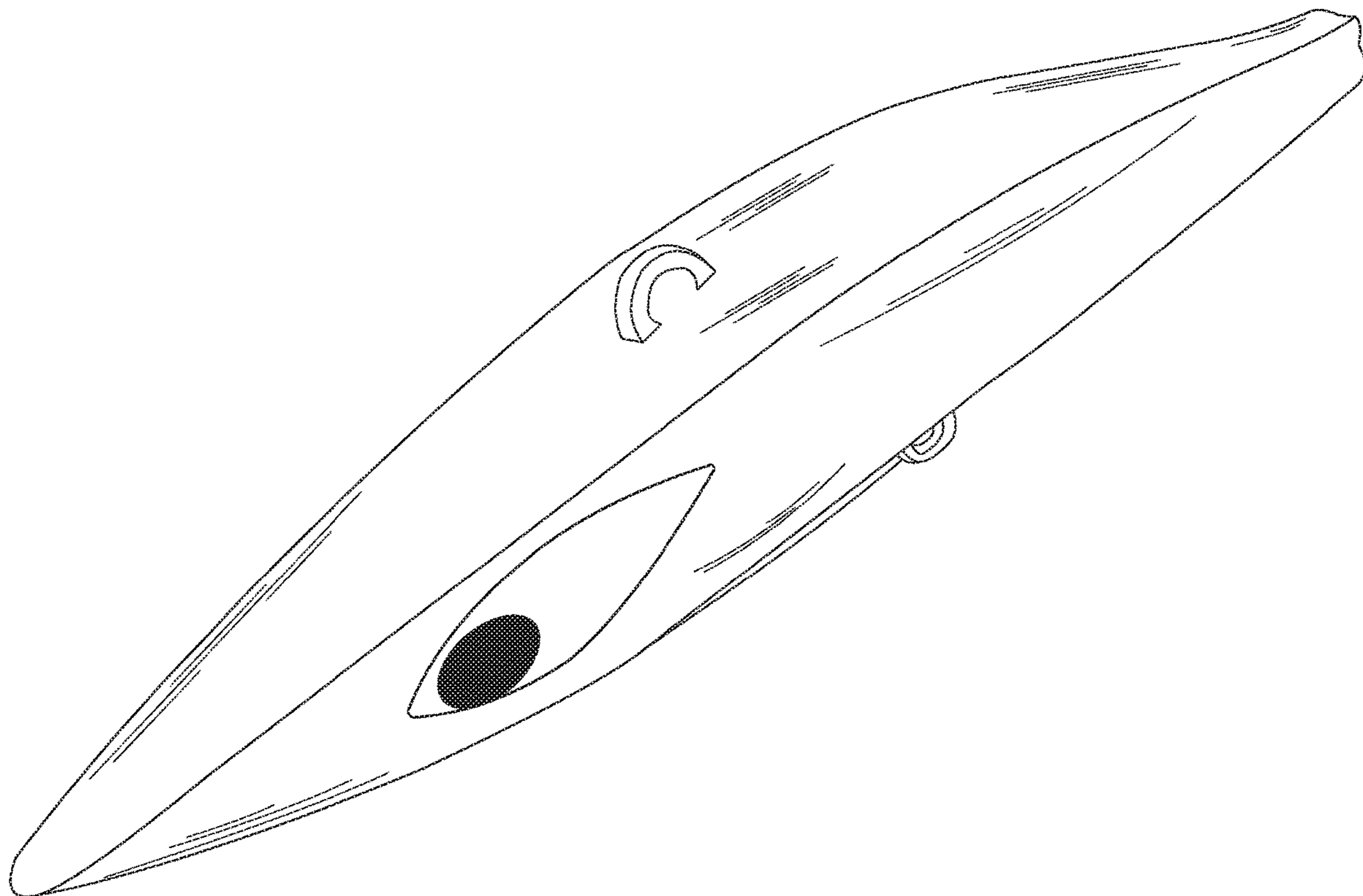

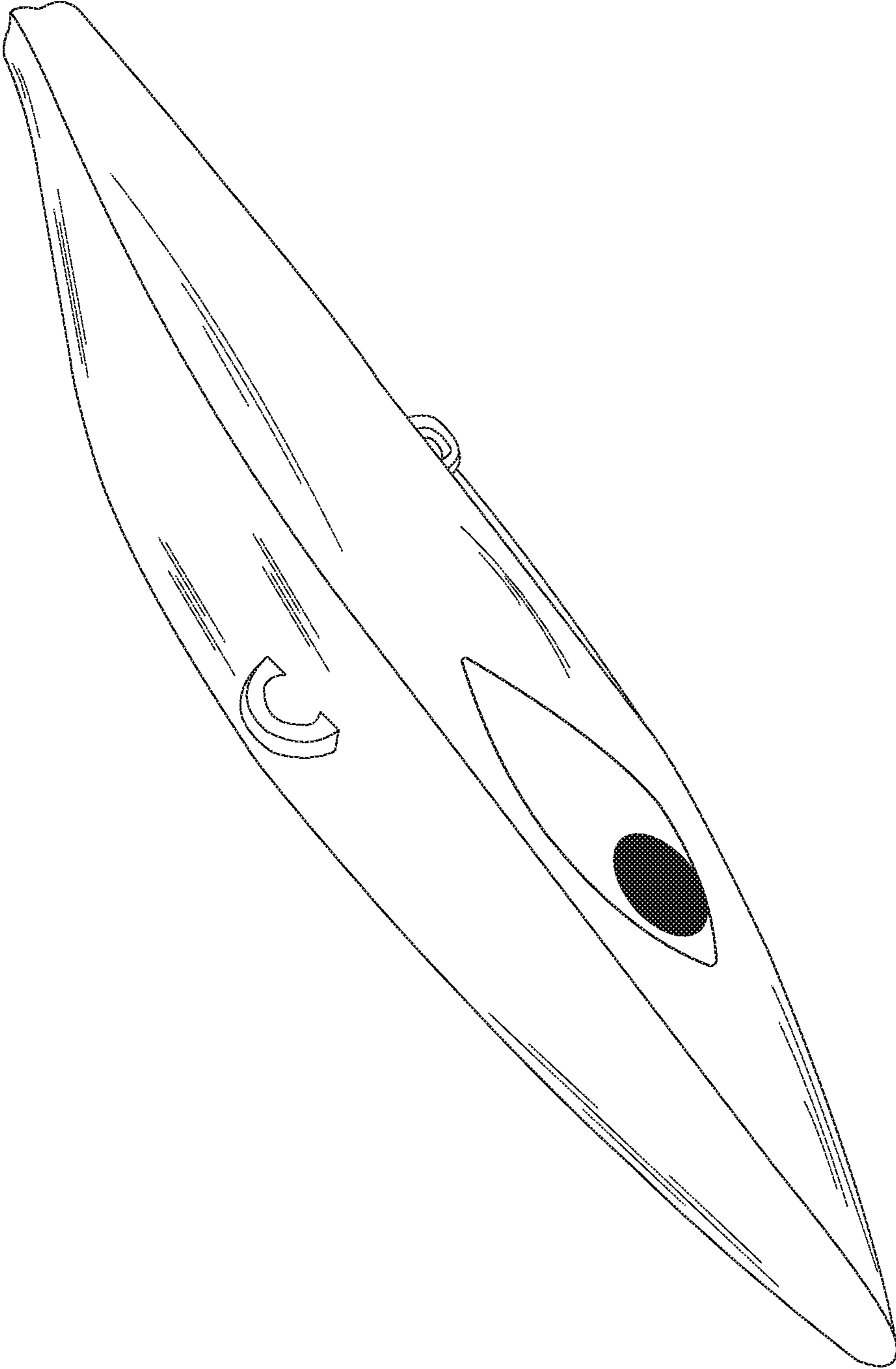

FIG. 1

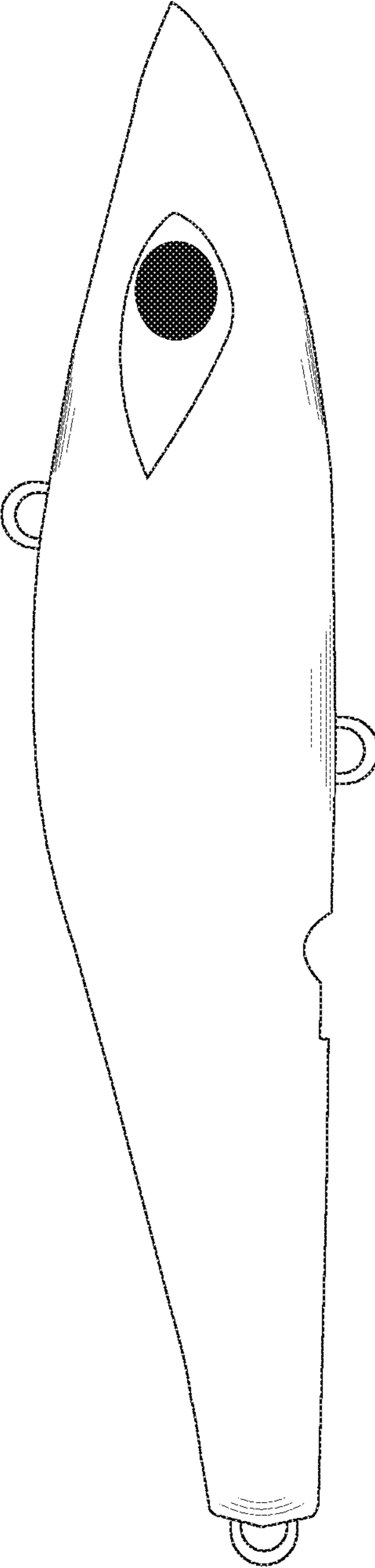

FIG. 2

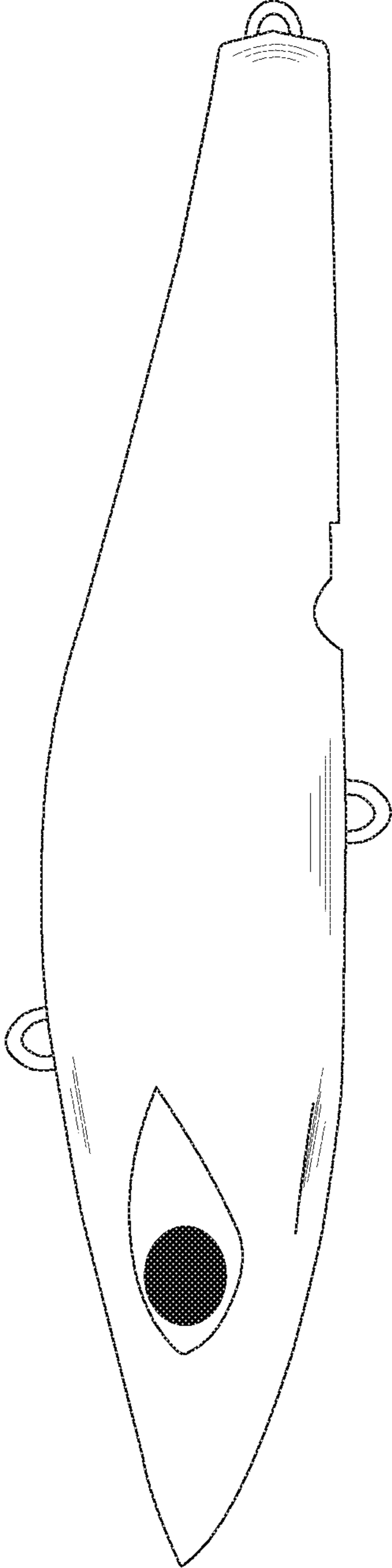

FIG. 3

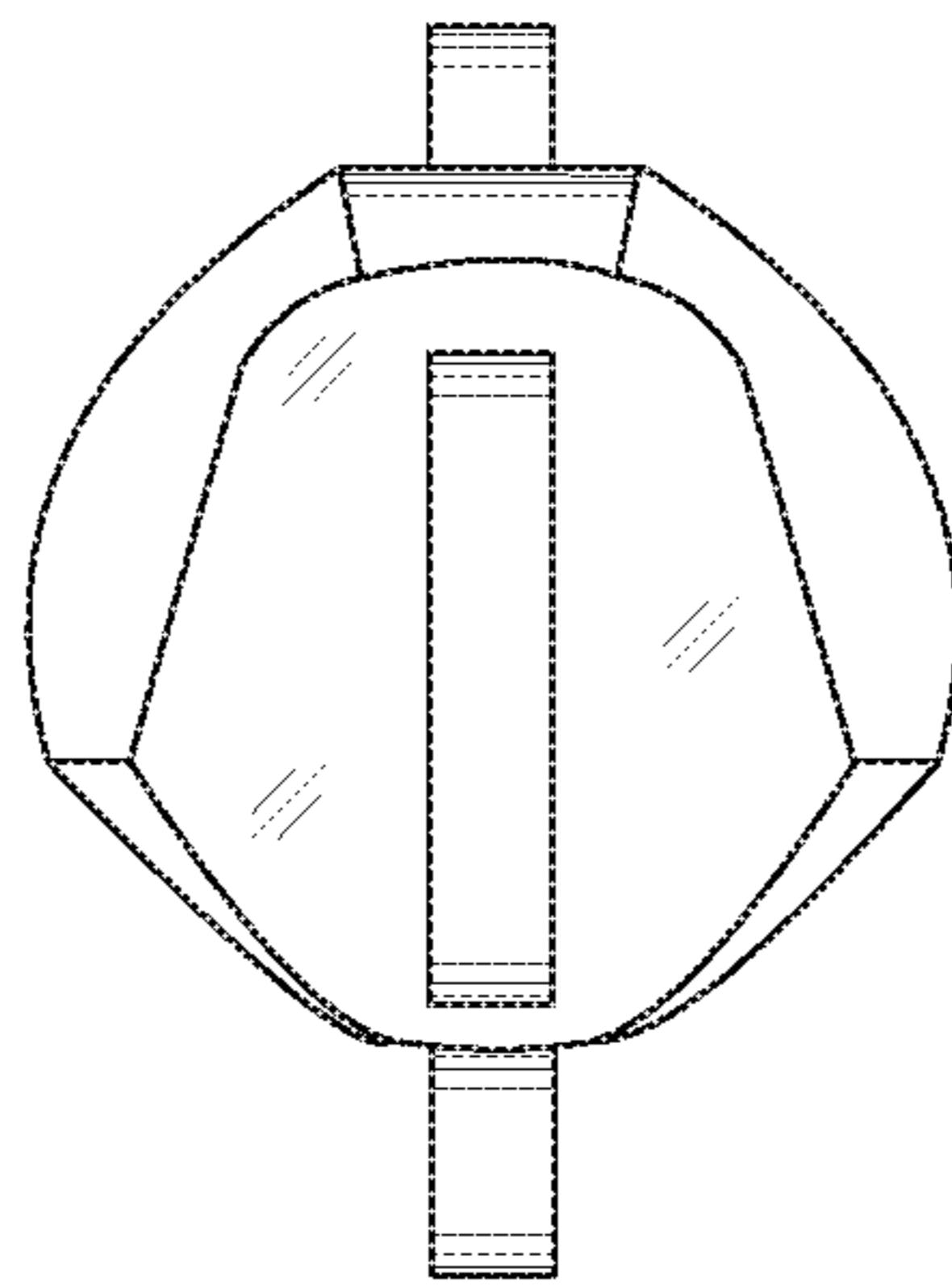

FIG. 4

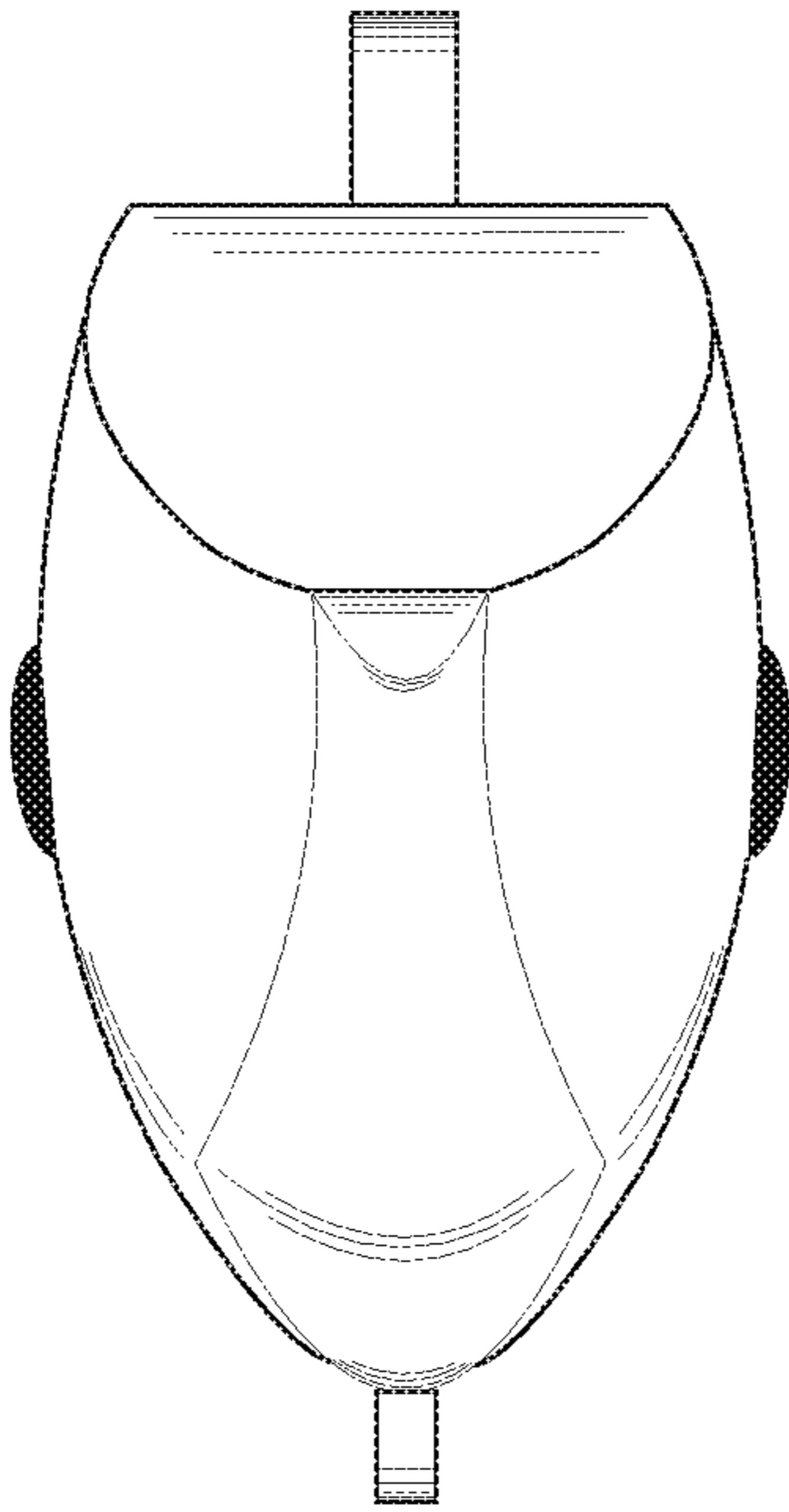

FIG. 5

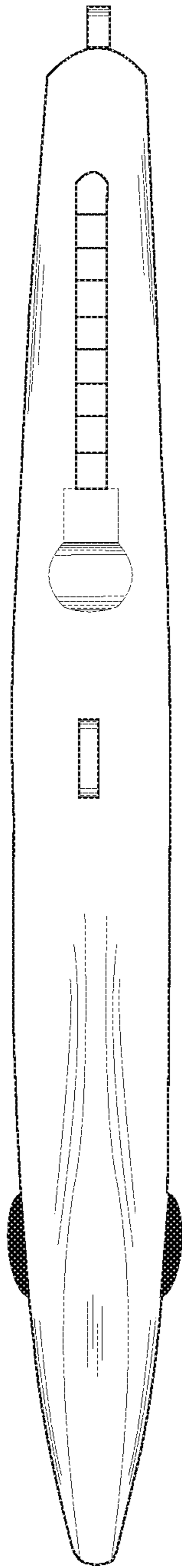

FIG. 6

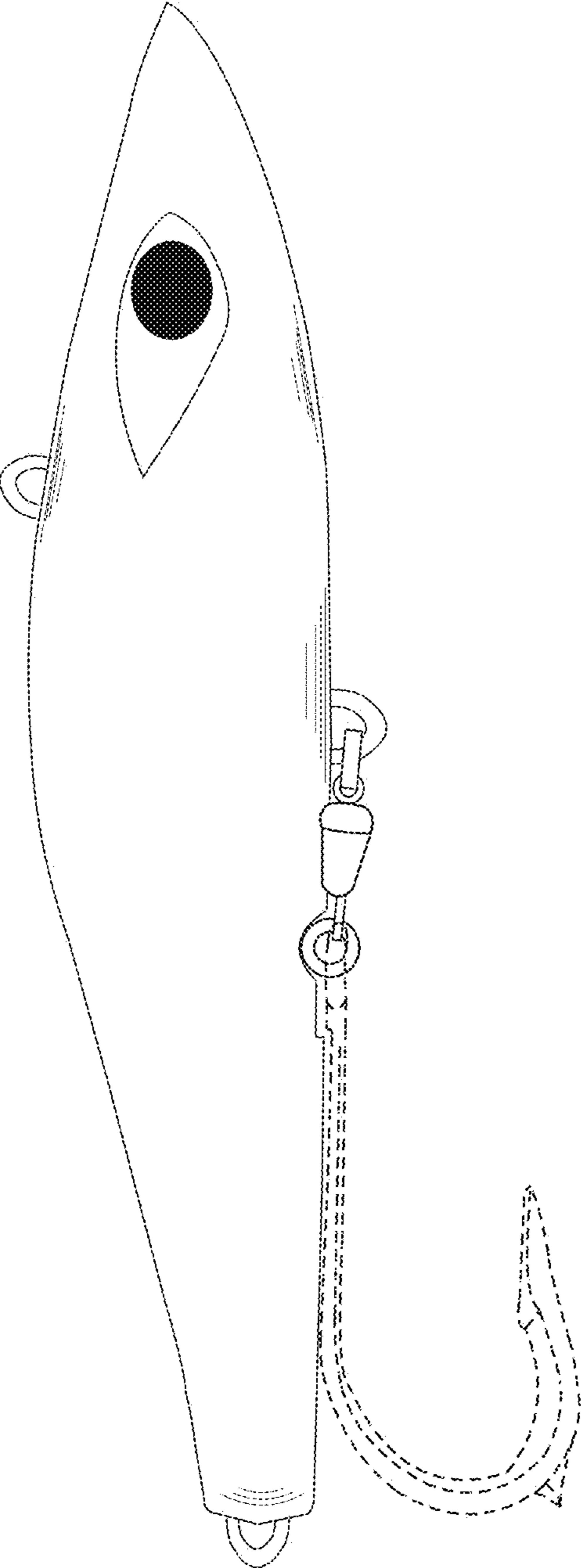

FIG. 7