



US00D888871S

(12) **United States Design Patent**
Alomaira

(10) **Patent No.:** **US D888,871 S**

(45) **Date of Patent:** **** Jun. 30, 2020**

(54) **SUPPRESSOR**

(71) Applicant: **Caracal International, LLC**, Abu Dhabi (AE)

(72) Inventor: **Naser Ali Alomaira**, Khalifa A (AE)

(73) Assignee: **CARACAL INTERNATIONAL, LLC**, Abu Dhabi (AE)

(**) Term: **15 Years**

(21) Appl. No.: **29/677,410**

(22) Filed: **Jan. 20, 2019**

(51) **LOC (12) Cl.** **22-01**

(52) **U.S. Cl.**
USPC **D22/108**

(58) **Field of Classification Search**
USPC D22/108
CPC F41A 21/30; F41A 21/325
See application file for complete search history.

(56) **References Cited**

U.S. PATENT DOCUMENTS

D776,226 S * 1/2017 Green D22/108
D779,621 S * 2/2017 Salvador D22/108
D802,700 S * 11/2017 Shults D22/108

D808,490 S * 1/2018 Meinert D22/108
D859,566 S * 9/2019 Mooty D22/108
D860,369 S * 9/2019 Sakash D22/108
2017/0205175 A1 * 7/2017 Garst F41A 21/30
2018/0321008 A1 * 11/2018 Barney F41A 21/30
2018/0347931 A1 * 12/2018 Schoppman F41A 21/325

* cited by examiner

Primary Examiner — Michael A. Pratt

(74) *Attorney, Agent, or Firm* — Bennet K. Langlotz;
Langlotz Patent & Trademark Works, LLC

(57) **CLAIM**

The ornamental design for a suppressor, as shown and described.

DESCRIPTION

FIG. 1 is a rear perspective view of a suppressor showing my new design;
FIG. 2 is a front perspective view thereof;
FIG. 3 is a right side view thereof;
FIG. 4 is a left side view thereof;
FIG. 5 is a top view thereof;
FIG. 6 is a bottom view thereof;
FIG. 7 is a rear end view thereof; and,
FIG. 8 is a front end view thereof.

The broken lines form no part of the claimed design.

1 Claim, 4 Drawing Sheets

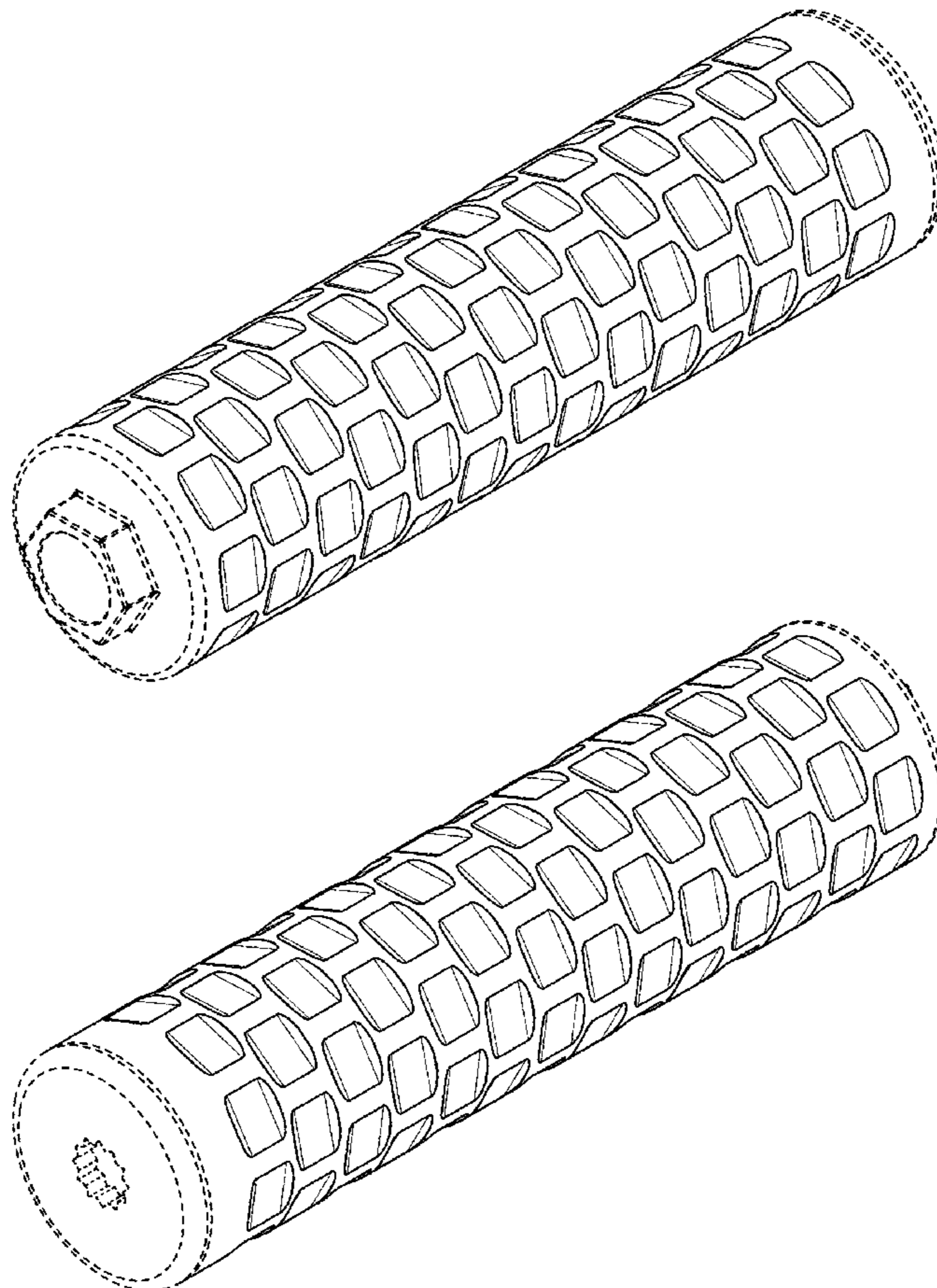

FIG. 1

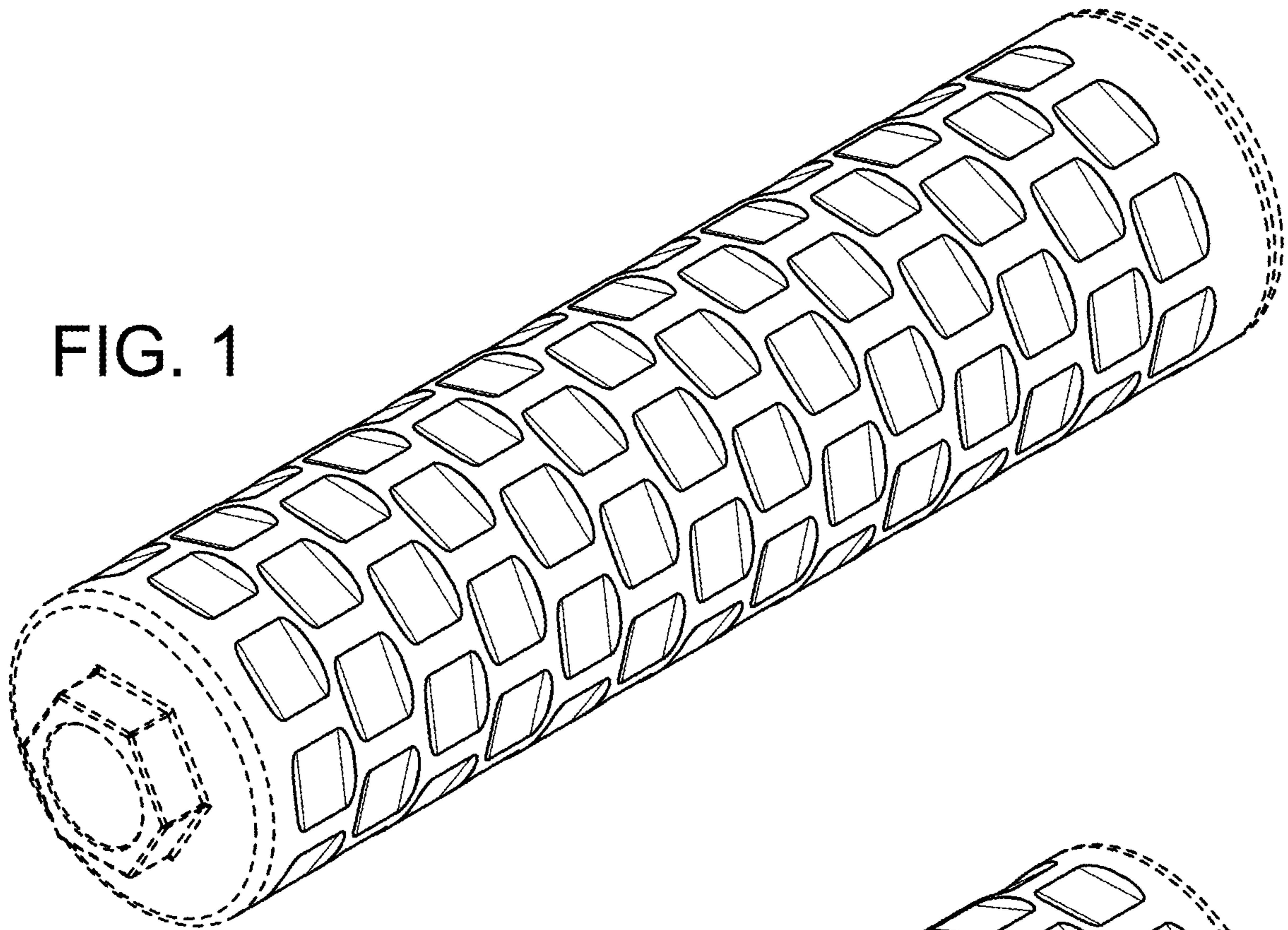
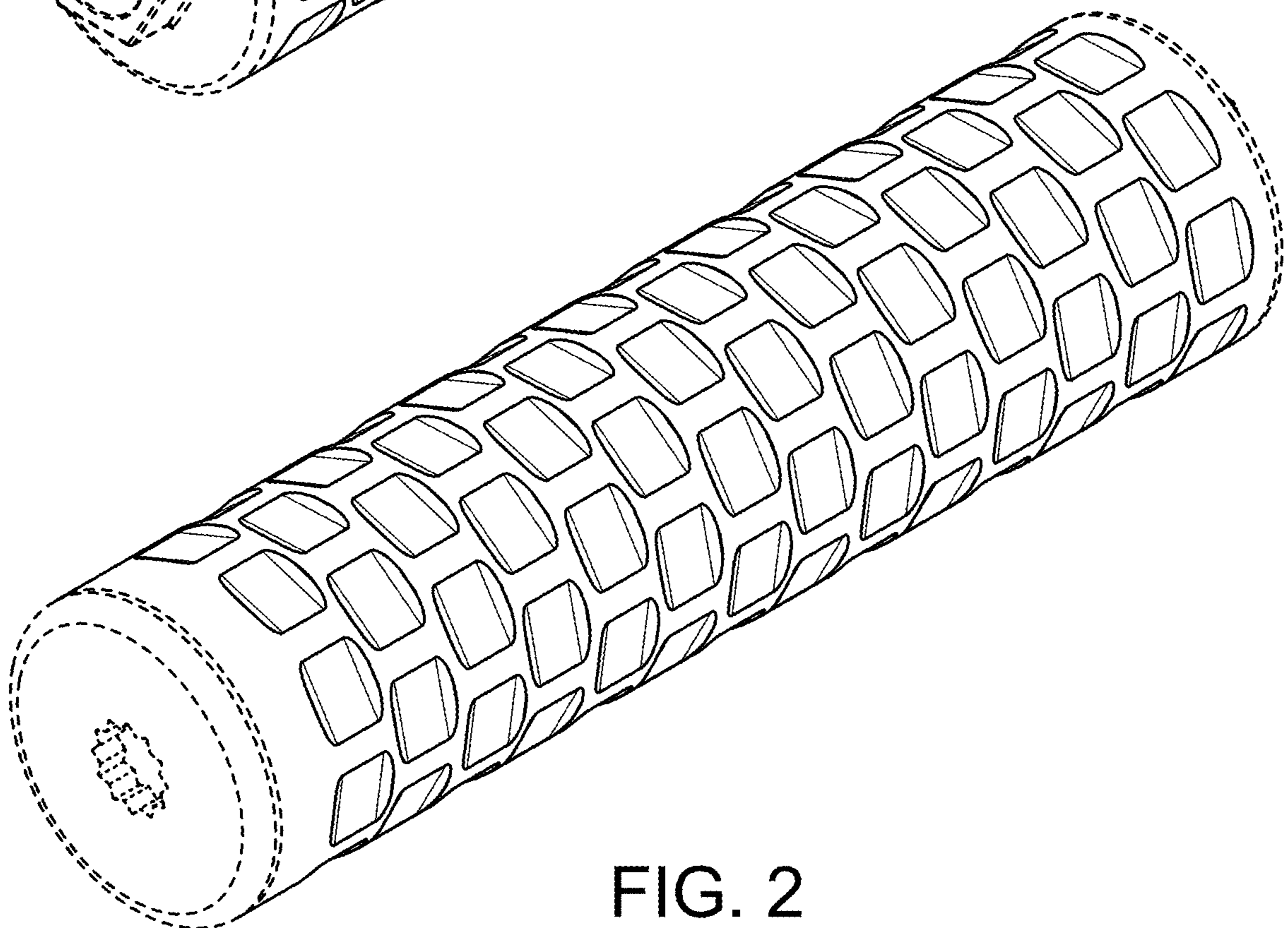

FIG. 2



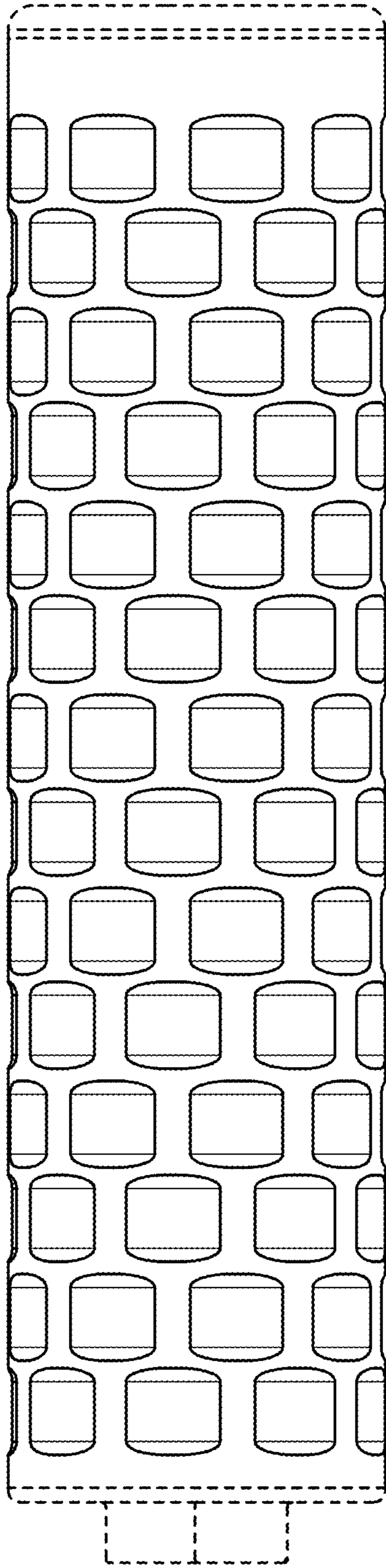

FIG. 3

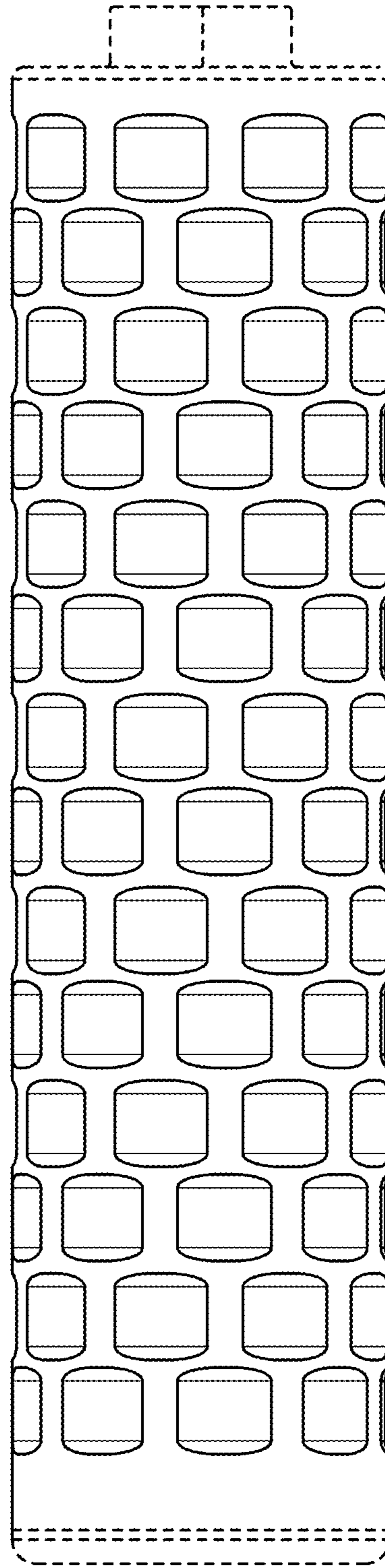

FIG. 4

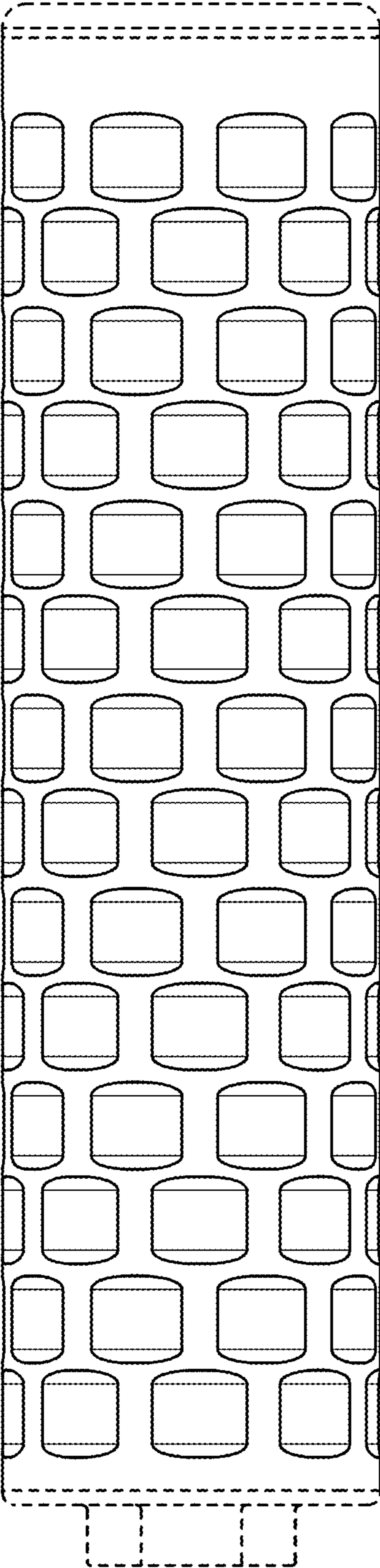

FIG. 5

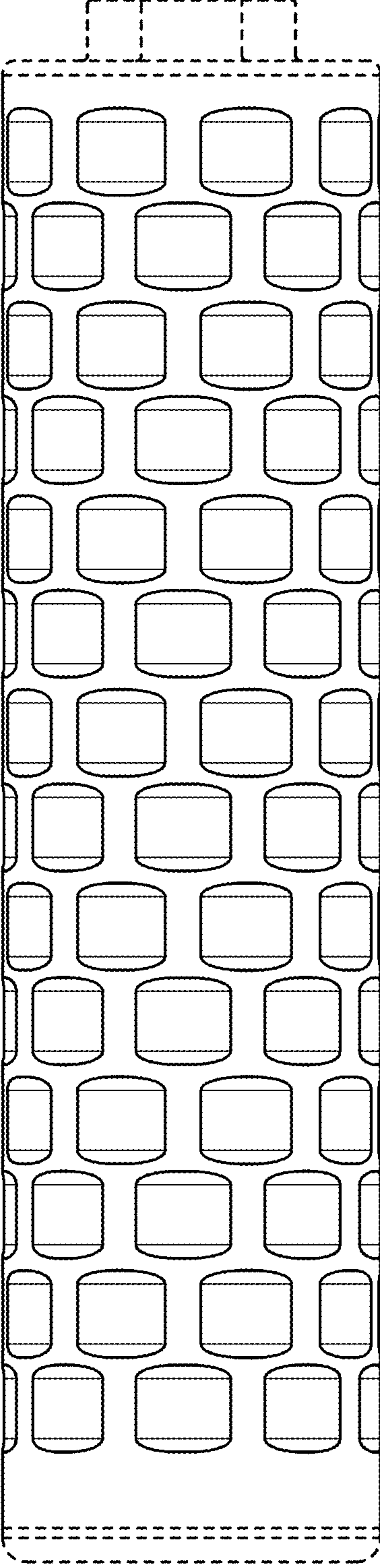

FIG. 6

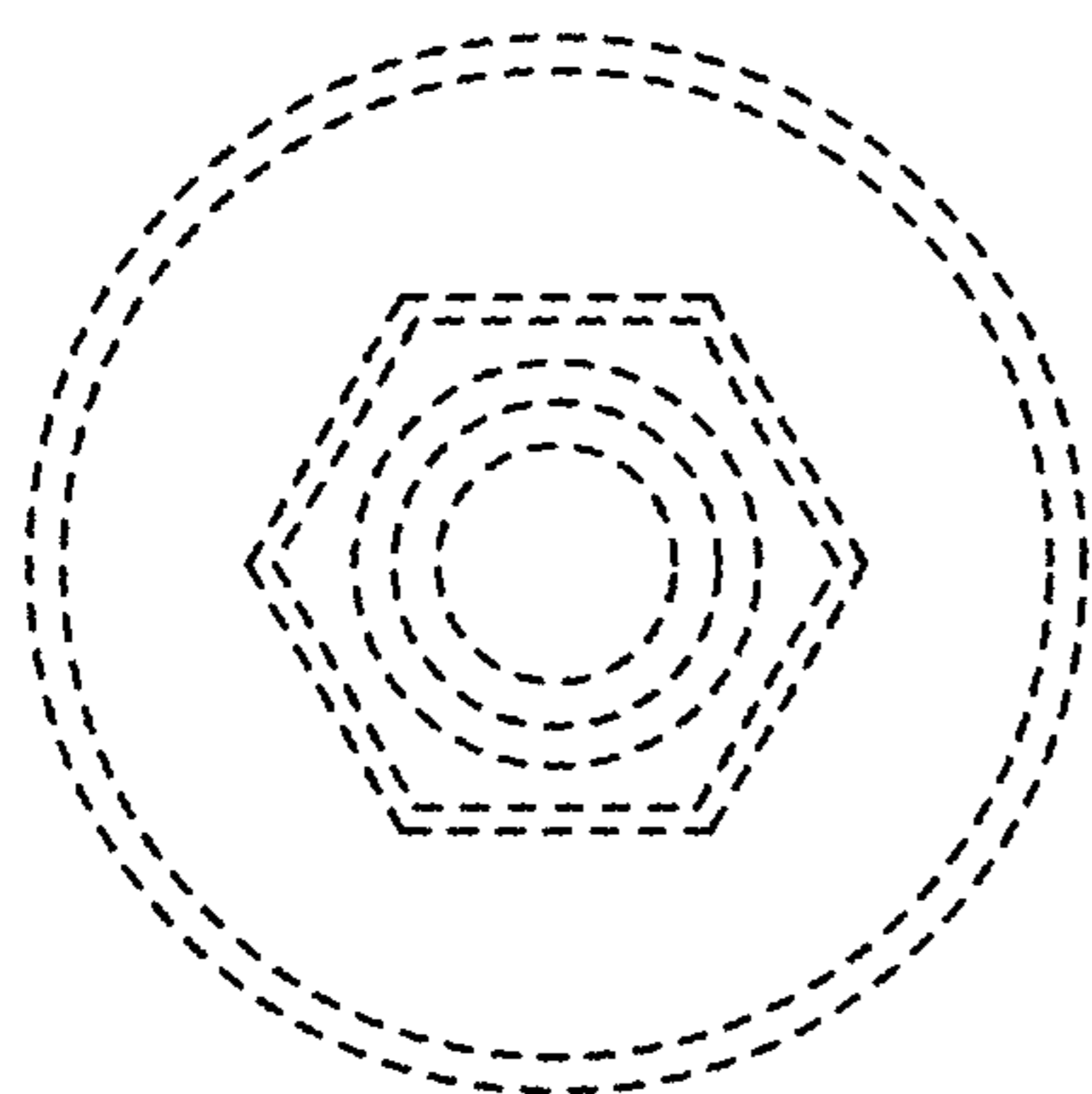

FIG. 7

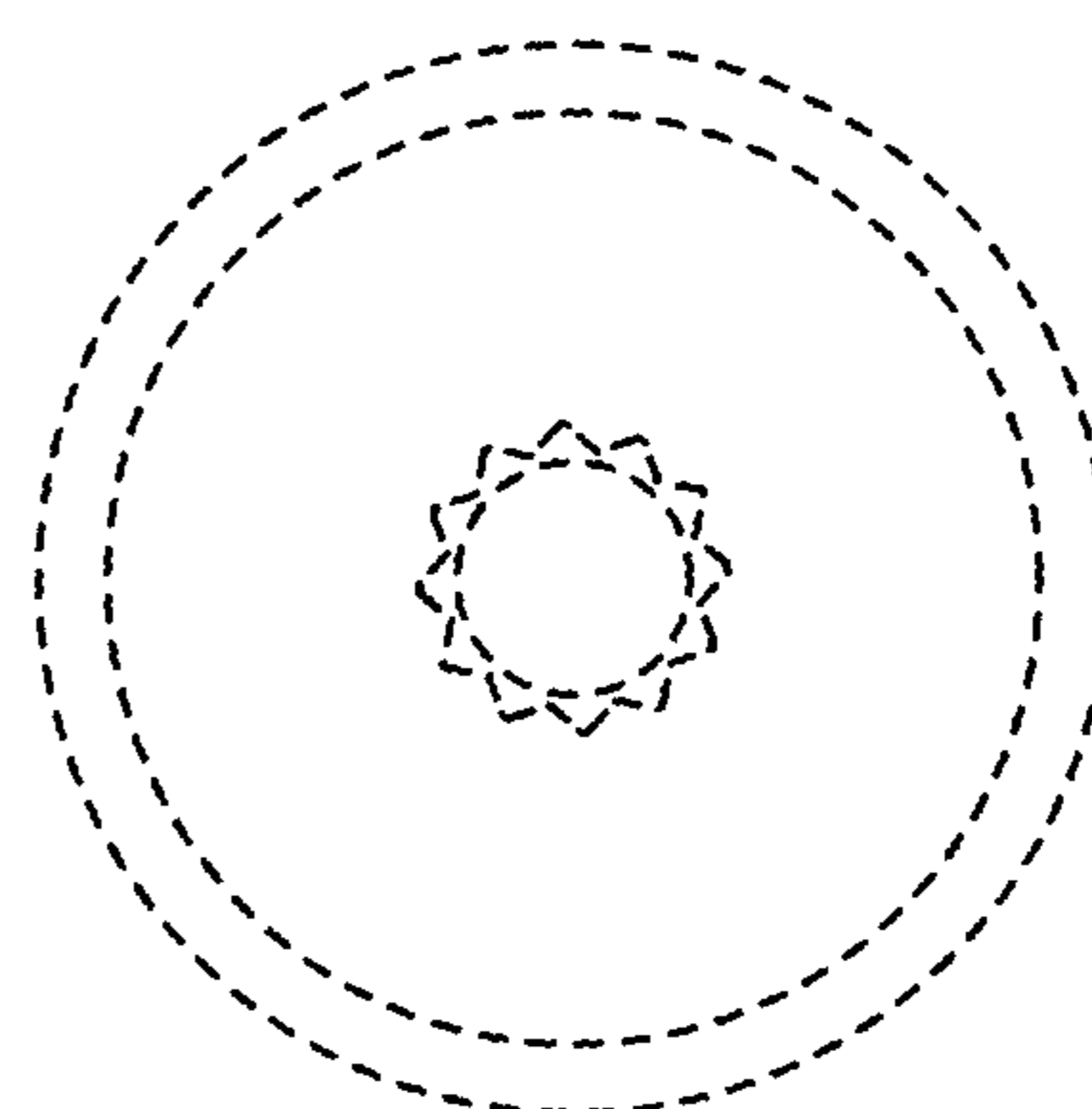

FIG. 8