



US00D888863S

(12) **United States Design Patent**
Bai

(10) **Patent No.:** **US D888,863 S**
(45) **Date of Patent:** **** Jun. 30, 2020**

(54) **TABLE TENNIS NET**

FOREIGN PATENT DOCUMENTS

(71) Applicant: **DECATHLON**, Villeneuve d'Ascq (FR)

CN 301531652 * 4/2011
CN 302309806 * 1/2013

(Continued)

(72) Inventor: **Yang Bai**, Nanterre (FR)

(73) Assignee: **DECATHLON**, Villeneuve d'Ascq (FR)

OTHER PUBLICATIONS

(**) Term: **15 Years**

Images of prior art Rollnet Artengo design, https://www.decathlon.fr/set-rollnet-standard-id_8395008.htmlhttps://www.decathlon.fr/set-rollnet-standard-id_8395008.html, available before Nov. 16, 2017.

(21) Appl. No.: **29/664,354**

Primary Examiner — Catherine A Tuttle

(22) Filed: **Sep. 24, 2018**

(74) *Attorney, Agent, or Firm* — Fross, Zelnick, Lehrman & Zissu, PC; Charles T. J. Weigell, Esq.

(30) **Foreign Application Priority Data**

Mar. 26, 2018 (EM) 005093002-0002

(51) **LOC (12) Cl.** **21-02**

(52) **U.S. Cl.**
USPC **D21/799.2**

(58) **Field of Classification Search**
USPC D21/305, 698, 705, 799.1, 799.2;
473/490-496

CPC A63B 2210/50; A63B 2210/58; A63B 61/00-04; A63B 61/02; A63B 7/04; A63B 7/045; A63B 7/18; A63B 71/0036; A63B 71/0045; A63B 71/023; A63B 71/028; A63B 2071/026; A63B 2243/0095; A63B 69/0095

See application file for complete search history.

(56) **References Cited**

U.S. PATENT DOCUMENTS

906,848 A * 12/1908 Atwell A63B 61/02
473/493
1,526,126 A * 2/1925 Fitzherbert A63B 61/02
473/493
2,817,526 A * 12/1957 Gross A63B 67/045
473/494

(57) **CLAIM**

The ornamental design for a table tennis net, as shown and described.

DESCRIPTION

FIG. 1 is a front perspective view of a table tennis net showing my new design, in a closed position;
FIG. 2 is a front view thereof;
FIG. 3 is a back view thereof;
FIG. 4 is a right side view thereof;
FIG. 5 is left side view thereof;
FIG. 6 is a top view thereof;
FIG. 7 is a bottom view thereof;
FIG. 8 is a front perspective view showing the design, shown in an open position;
FIG. 9 is a front view thereof;
FIG. 10 is a back view thereof;
FIG. 11 is a right side view thereof;
FIG. 12 is left side view thereof;
FIG. 13 is a top view thereof; and,
FIG. 14 is a bottom view thereof.
The broken line depiction of the netting forms no part of the claimed design.

(Continued)

1 Claim, 14 Drawing Sheets

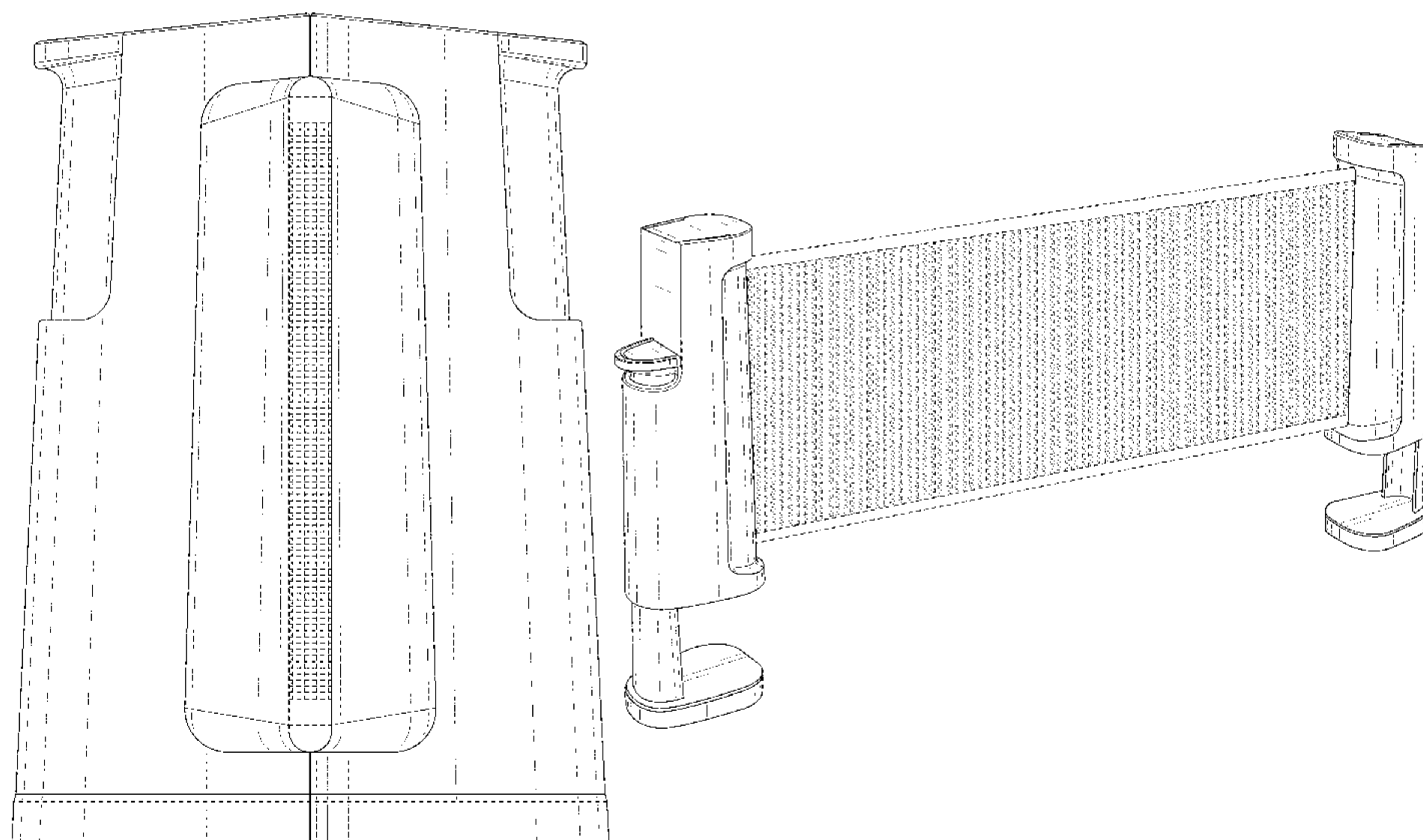

(56)

References Cited

U.S. PATENT DOCUMENTS

3,931,965 A * 1/1976 Grant A63B 61/02
 473/493
 4,088,317 A * 5/1978 Gierla A63B 61/00
 242/532
 4,850,590 A * 7/1989 Lin A63B 67/045
 473/491
 7,104,903 B1 * 9/2006 Chen A63B 67/045
 473/491
 D584,368 S * 1/2009 Stoewhass D21/705
 8,182,374 B1 * 5/2012 Copeland A63B 61/02
 473/473
 2008/0139344 A1 * 6/2008 Nally A63B 67/045
 473/496

FOREIGN PATENT DOCUMENTS

CN 302695810 * 12/2013
 CN 302843008 * 6/2014
 CN 203710640 U * 7/2014 A63B 67/04
 CN 203954628 U * 11/2014 A63B 67/04
 CN 3039591656 * 2/2016
 CN 205323155 U * 6/2016 A63B 67/04
 CN 105749513 A * 7/2016 A63B 61/003
 CN 205386320 U * 7/2016 A63B 67/04
 EM 000799176-0001 9/2007
 EM 001221428-0001 6/2010
 EM 004510022-0001 * 6/2018
 FR 3048893 A3 * 9/2017
 GB 190211641 A * 12/1902

* cited by examiner

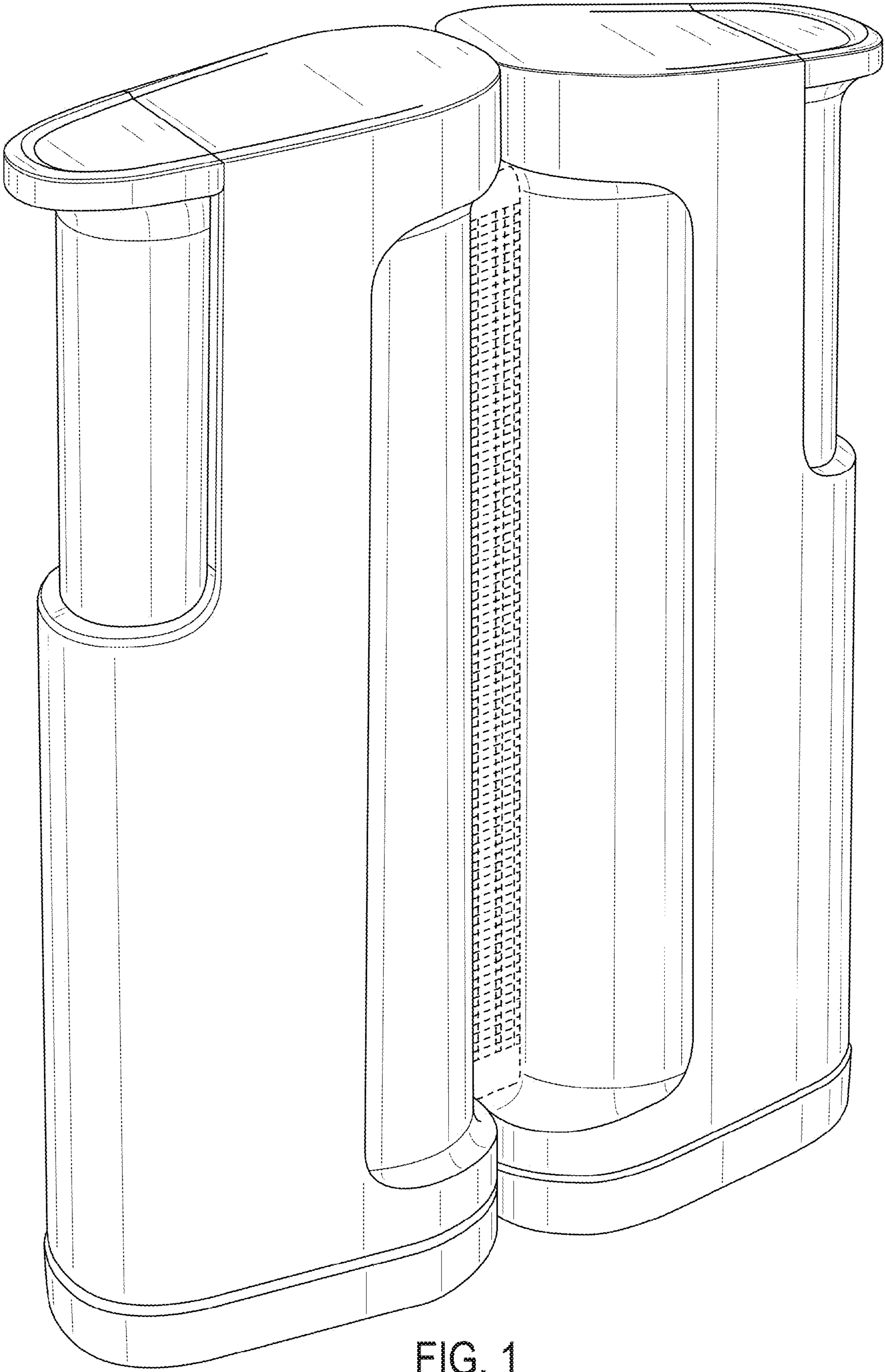

FIG. 1

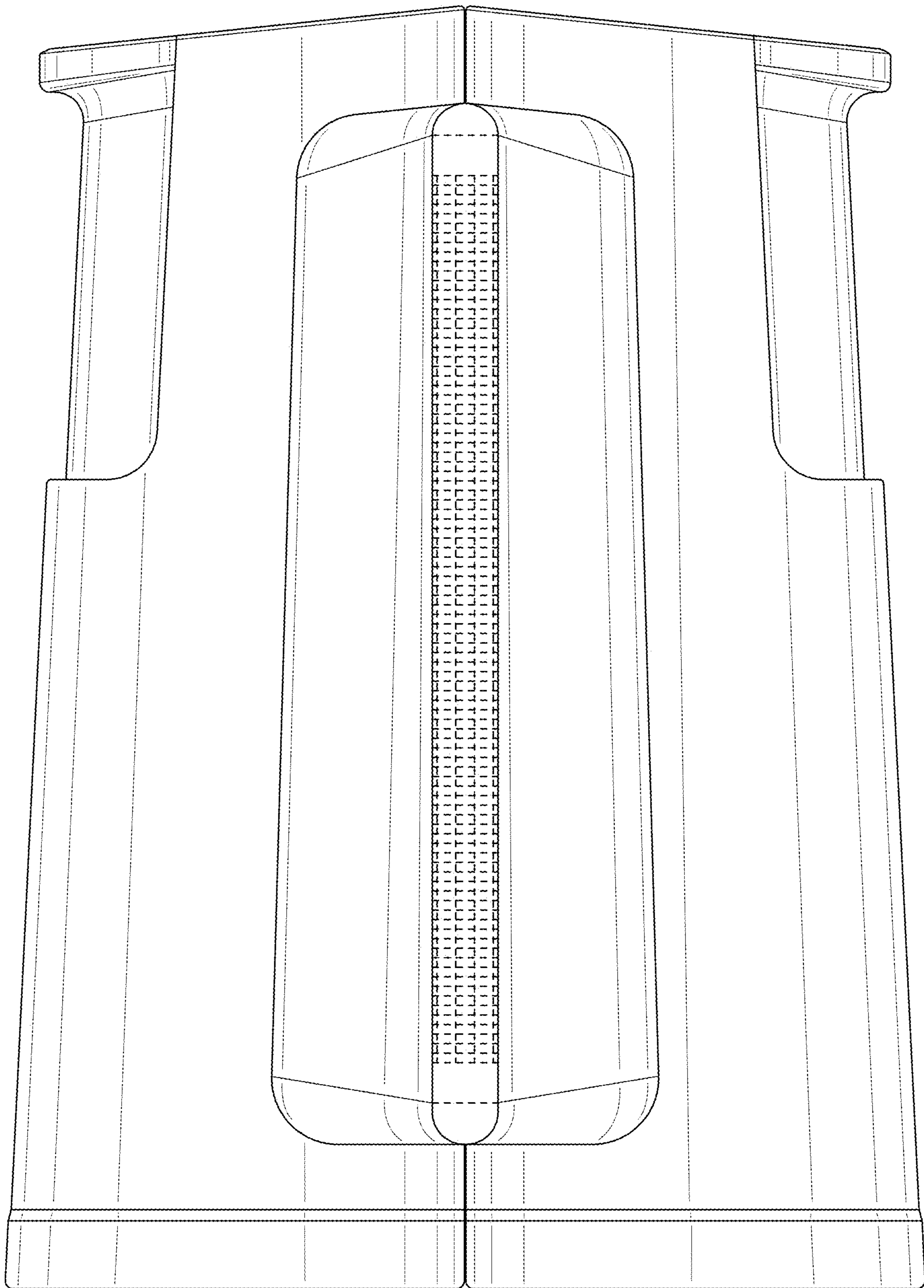

FIG. 2

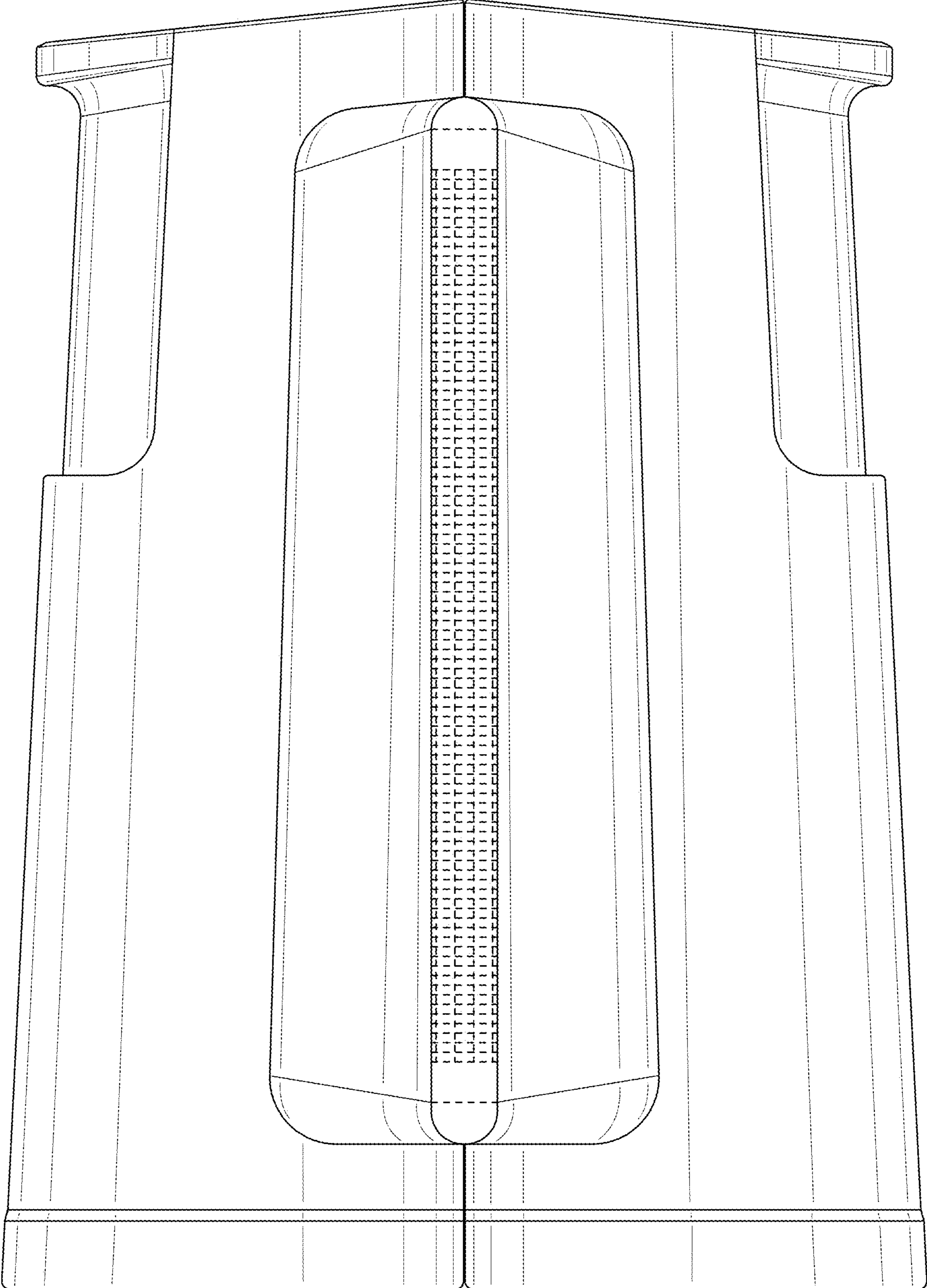

FIG. 3

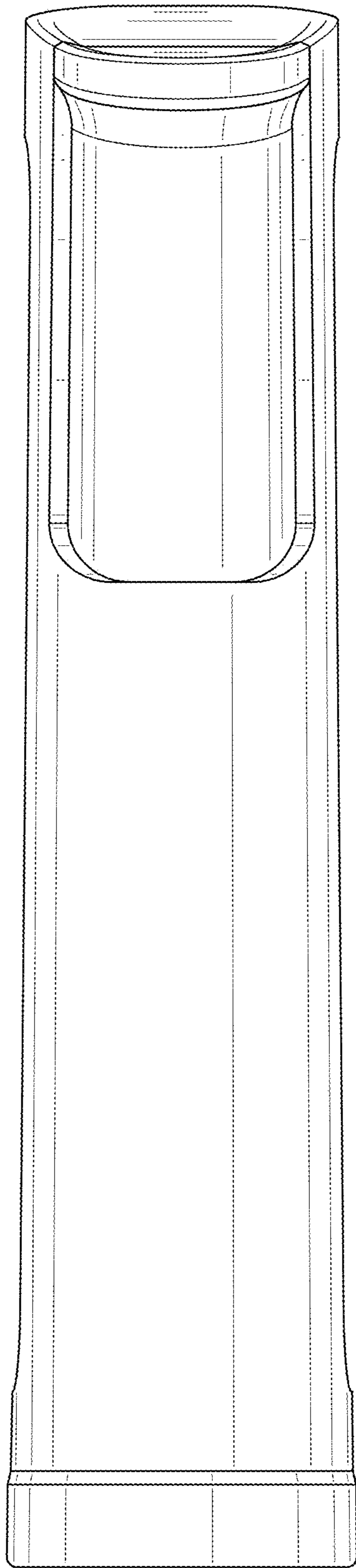

FIG. 4

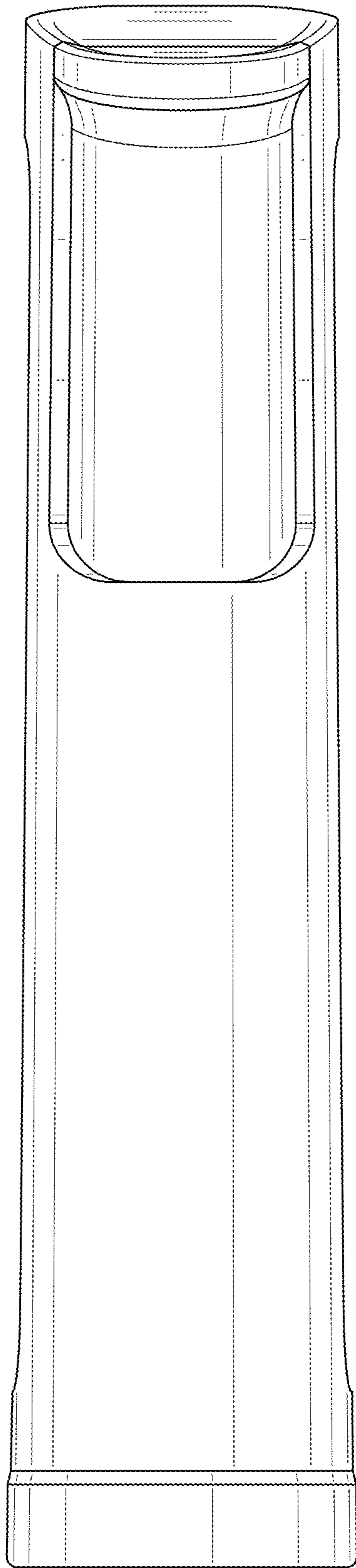

FIG. 5

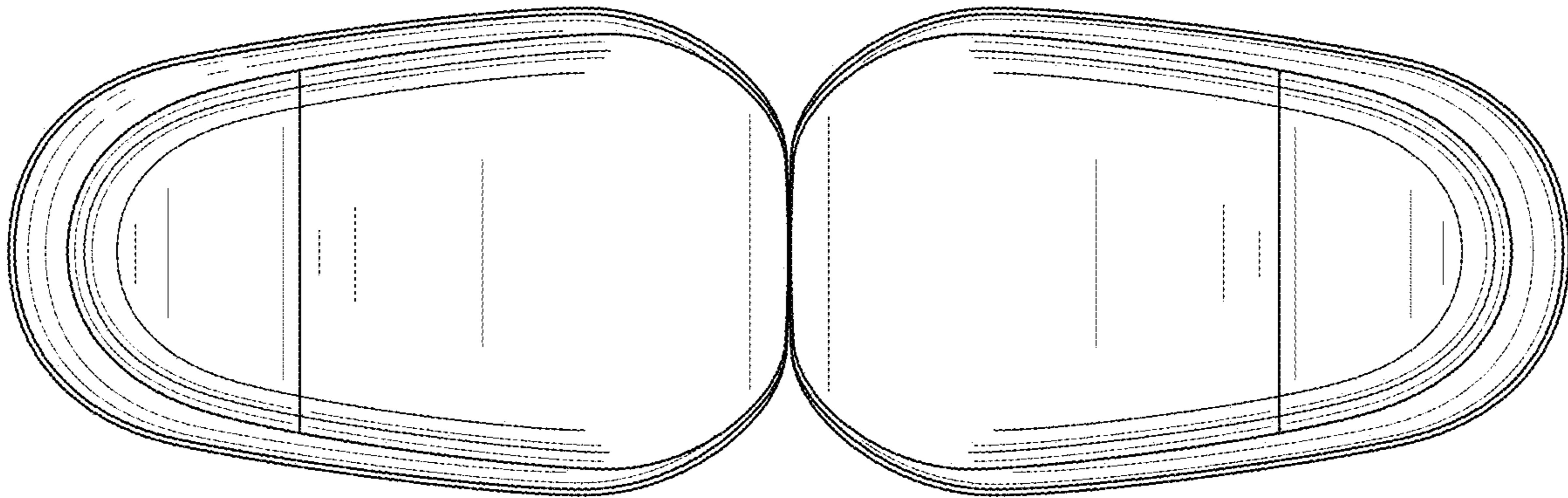

FIG. 6

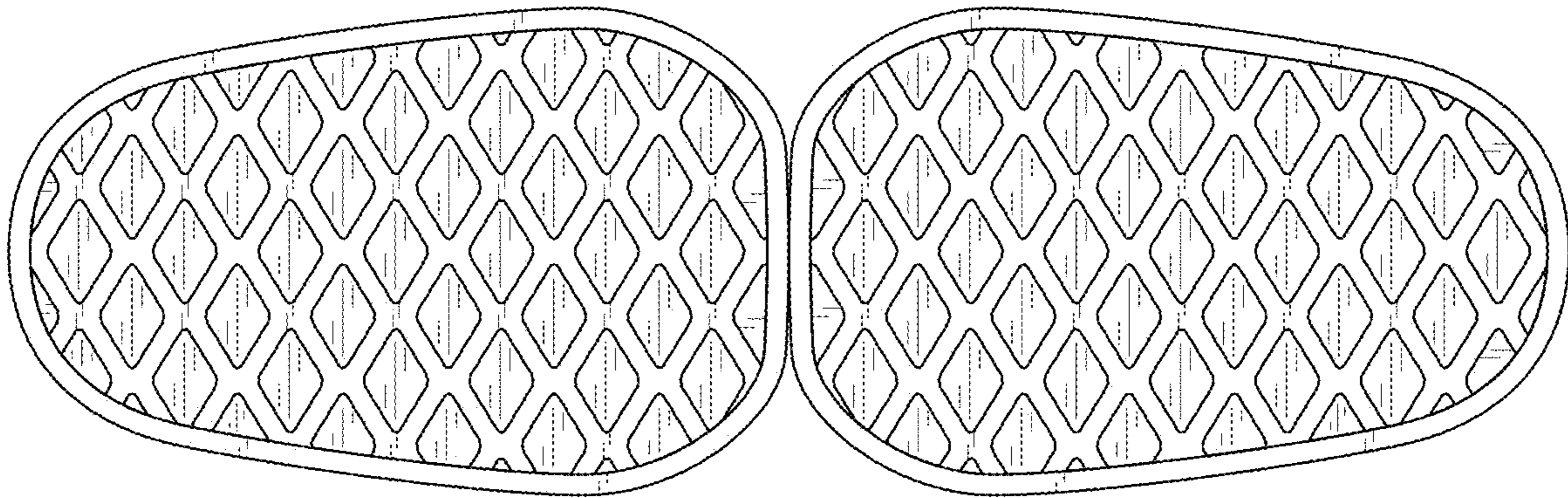

FIG. 7

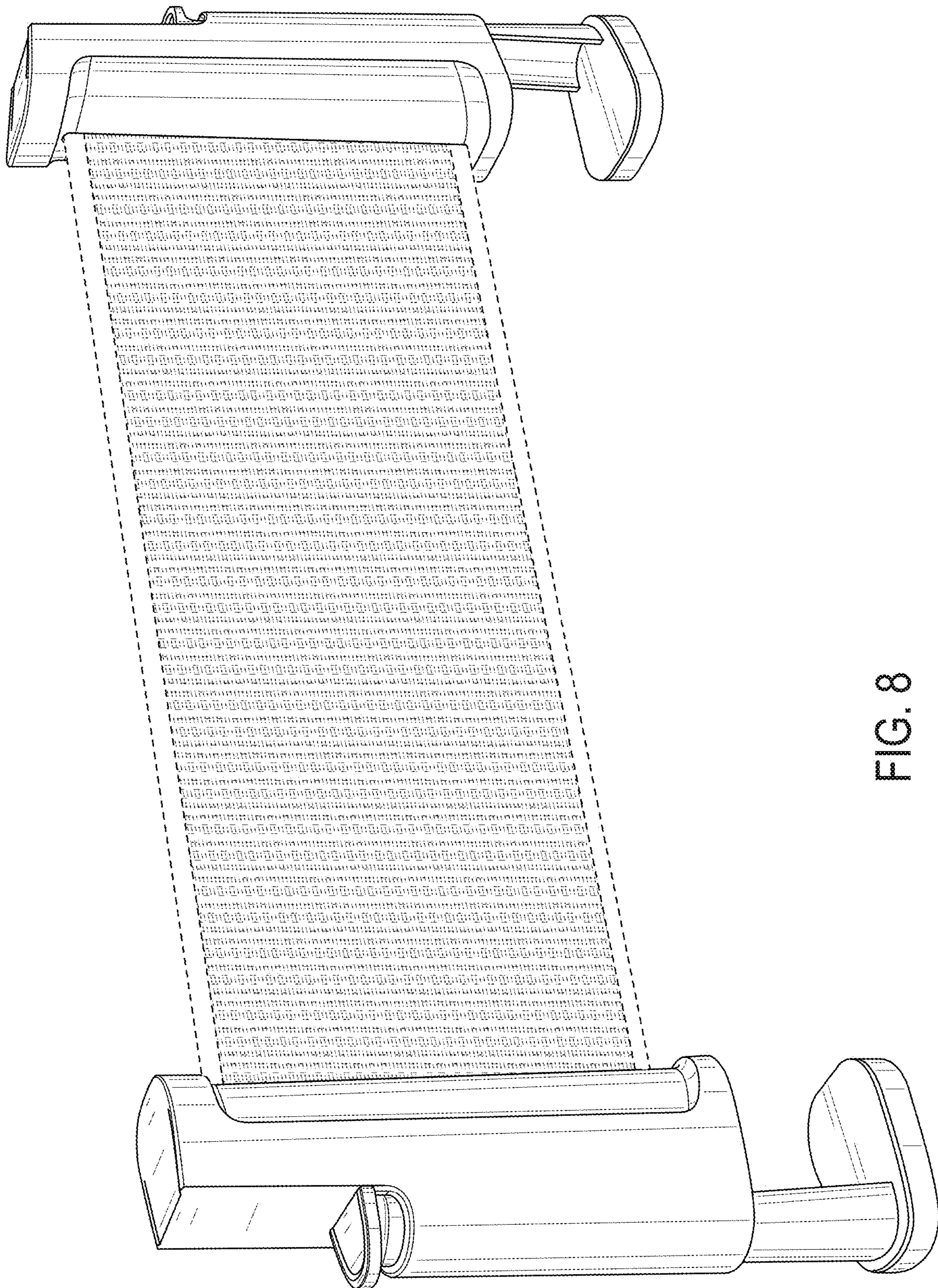

FIG. 8

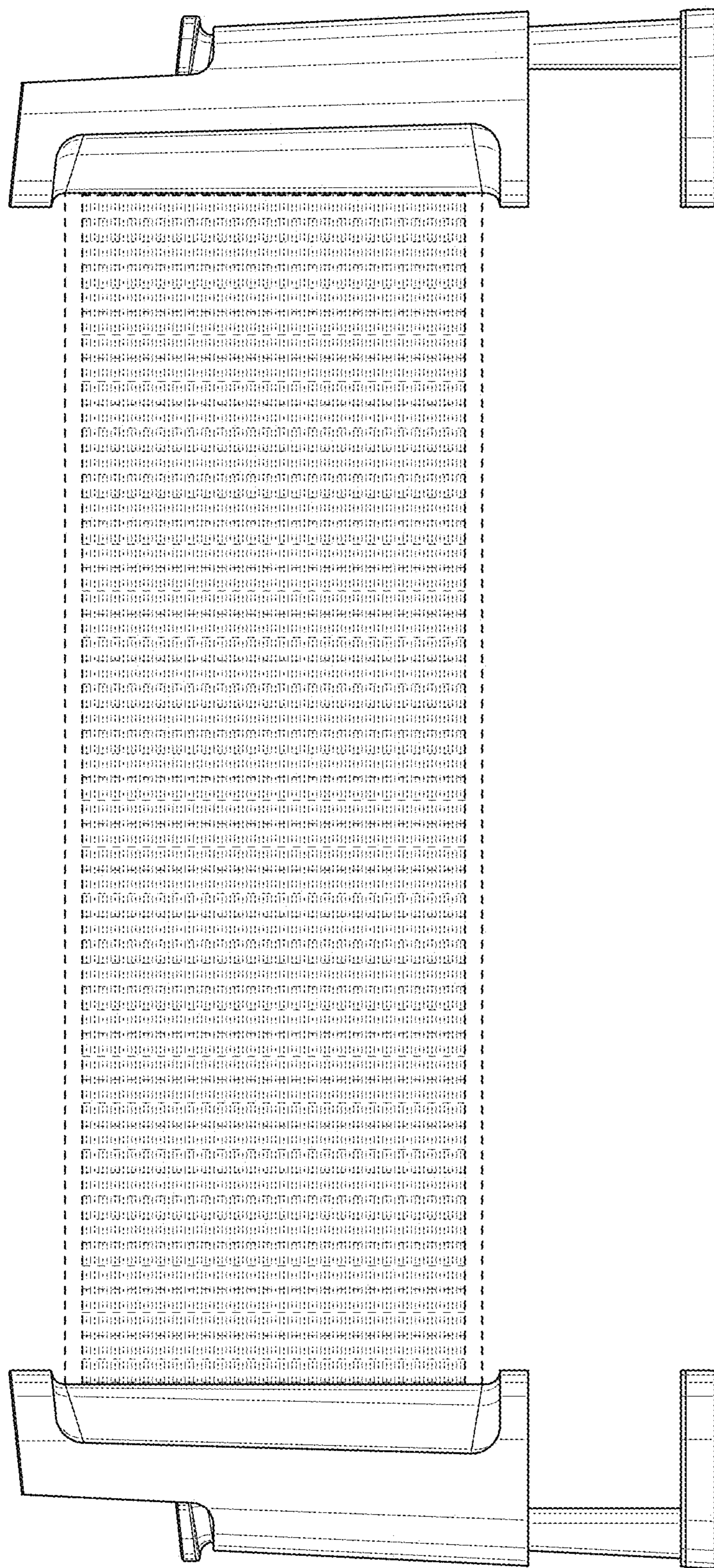

FIG. 9

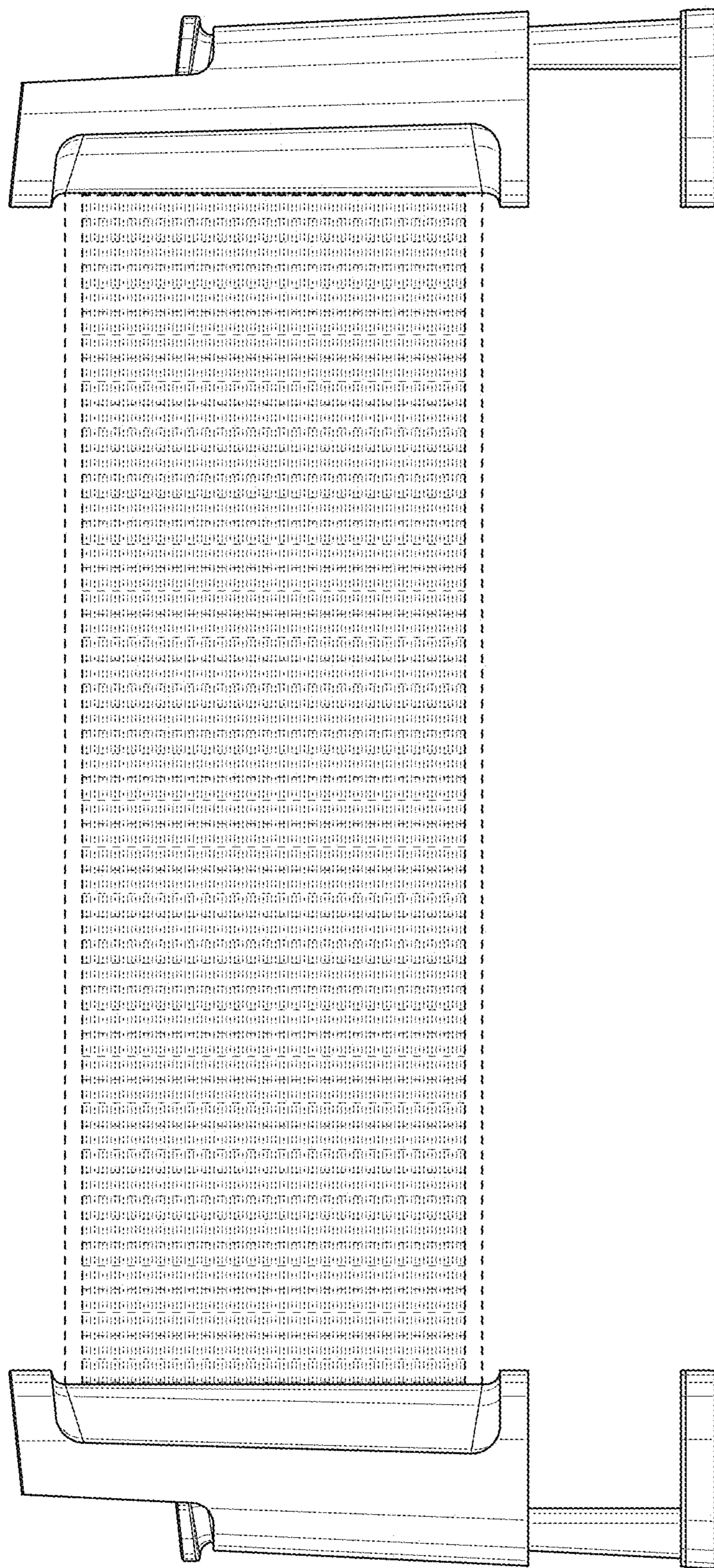

FIG. 10

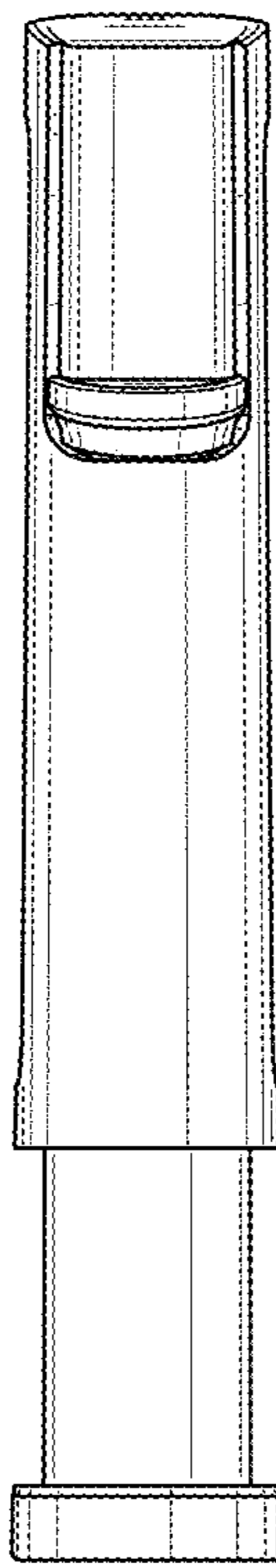

FIG. 11

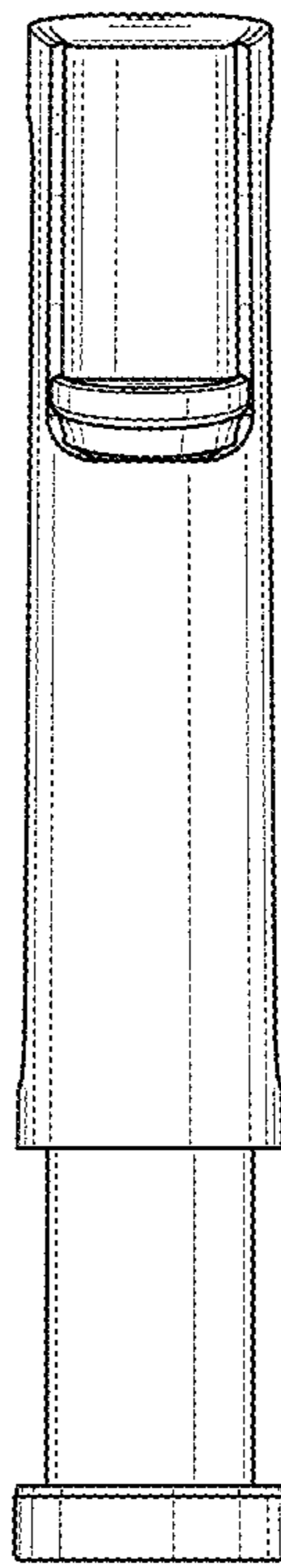

FIG. 12

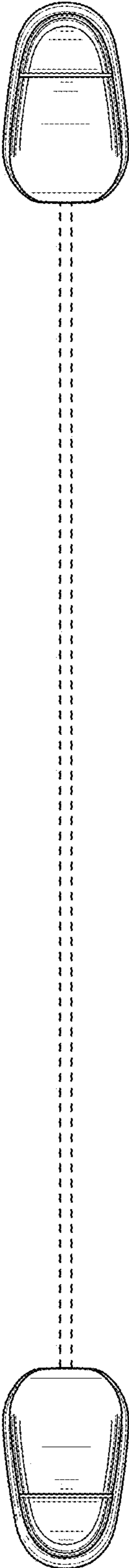

FIG. 13

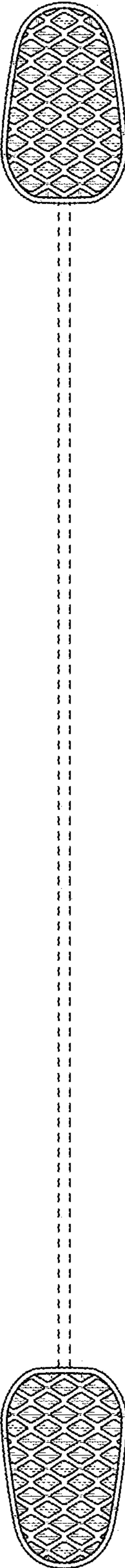

FIG. 14