



US00D888851S

(12) **United States Design Patent**
Dunahay

(10) **Patent No.:** **US D888,851 S**
(45) **Date of Patent:** **** Jun. 30, 2020**

(54) **WALL MOUNTED EXERCISE RACK**

FOREIGN PATENT DOCUMENTS

(71) Applicant: **Coulter Ventures LLC**, Columbus, OH (US)

EP 2400205 A1 12/2011
WO 2008054720 A2 5/2008
WO 2009003280 A1 1/2009

(72) Inventor: **Nash Dunahay**, Gahanna, OH (US)

(73) Assignee: **Coulter Ventures, LLC.**, Columbus, OH (US)

(**) Term: **15 Years**

(21) Appl. No.: **29/650,256**

(22) Filed: **Jun. 5, 2018**

(51) **LOC (12) Cl.** **21-02**

(52) **U.S. Cl.**
USPC **D21/686**; D8/354

(58) **Field of Classification Search**
USPC 312/351.1, 351.3, 351.5; 482/92, 94, 98, 482/99, 101, 104; D21/662, 673, 686, D21/691, 694, 826; D25/62, 66, 68, 119, D25/126, 136; D6/329; D8/323, 354
CPC A63B 21/00047; A63B 1/00; A63B 21/16; A63B 22/0046; A63B 21/078; A63B 21/169; A63B 2225/10; A63B 71/023
See application file for complete search history.

(56) **References Cited**

U.S. PATENT DOCUMENTS

88,047 A *	3/1869	Lawrence	A63B 21/154
				482/92
1,410,149 A	3/1922	Williams		
2,855,200 A	10/1958	Blickman		
D210,469 S	3/1968	Sejersen		
D265,111 S *	6/1982	Lynn	D21/673
D269,691 S	7/1983	Ornstein et al.		
D276,656 S	12/1984	Lindstrom		
D290,033 S	5/1987	Policastro		
D297,957 S	10/1988	Gordon, III		
4,934,693 A *	6/1990	Santoro	A63B 21/078
				482/104

(Continued)

OTHER PUBLICATIONS

Product listing for Rogue V2 Face Mount Pull-up Bar for Monster Lite from <https://web.archive.org/web/20161105161238/https://www.roguefitness.com/rogue-v2-face-mount-pull-up-bar-for-monster-lite>, dated Nov. 5, 2016.

(Continued)

Primary Examiner — Cynthia Ramirez
Assistant Examiner — Michael A Maharajh
(74) *Attorney, Agent, or Firm* — Banner & Witcoff, Ltd.

(57) **CLAIM**

The ornamental design for a wall mounted exercise rack, as shown and described.

DESCRIPTION

FIG. 1 is a top, front, right perspective view of a wall mounted exercise rack showing my new design; FIG. 2 is a front view thereof; FIG. 3 is a right side view thereof; FIG. 4 is a left side view thereof; FIG. 5 is a top view thereof; and, FIG. 6 is a top, front, left perspective view shown in a condition of use thereof.

The broken lines immediately adjacent to the shaded area are directed to boundary lines, which form no part of the claimed design. The broken lines in the drawings are for the purpose of illustrating portions of the Wall Mounted Exercise Rack, which form no part of the claimed design. The wall shown in broken lines are for the purpose of illustrating environmental structure, which form no part of the claimed design.

1 Claim, 6 Drawing Sheets

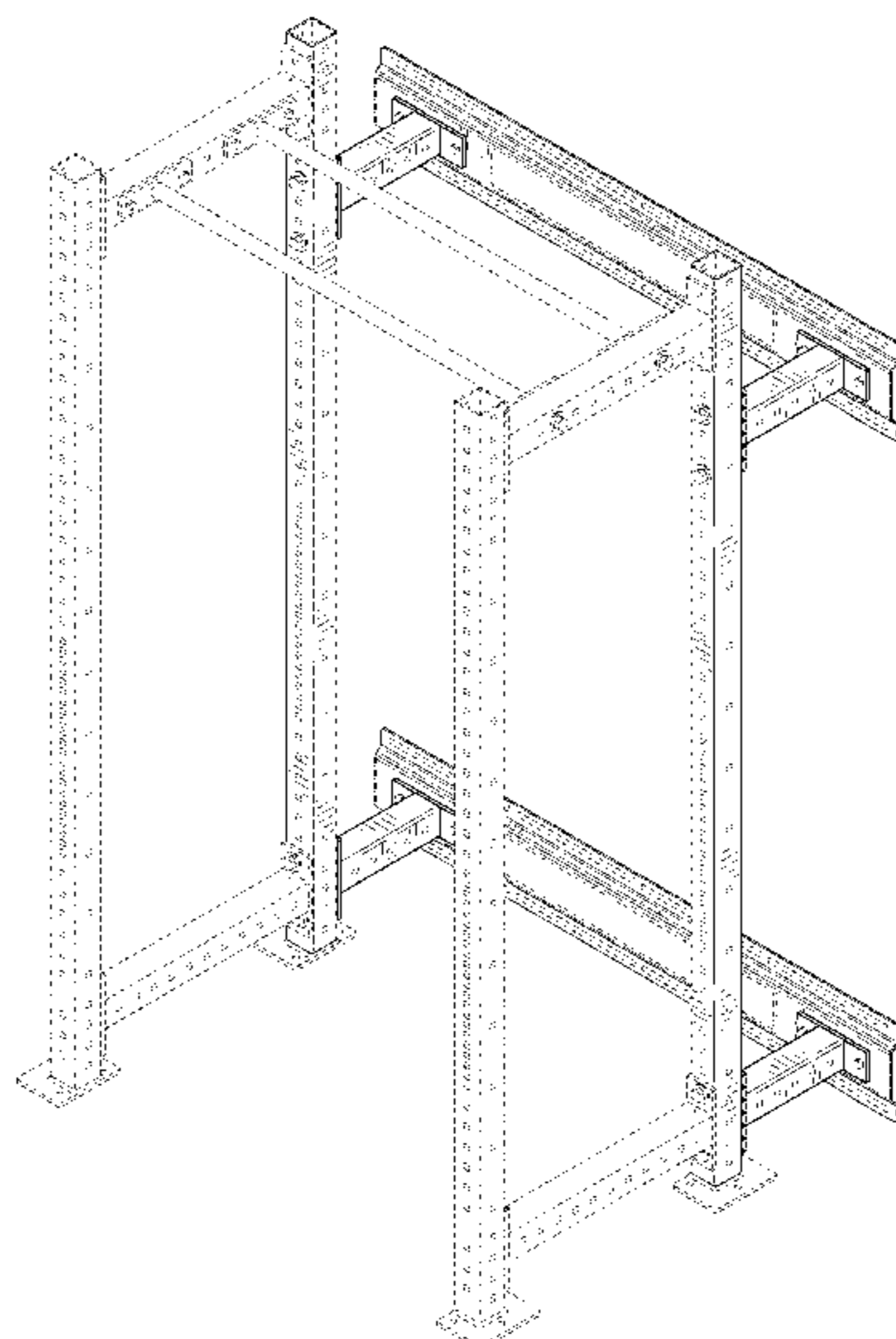

(56)

References Cited

U.S. PATENT DOCUMENTS

4,961,295	A	10/1990	Kosch, Sr. et al.	9,844,691	B2	12/2017	Hopperstad et al.
5,046,722	A	9/1991	Antoon	D816,173	S	4/2018	Jackson
5,135,077	A *	8/1992	Shalders E04G 1/14	9,993,678	B2	6/2018	Hopperstad et al.
			D25/66	D836,617	S *	12/2018	Shu D14/239
5,184,992	A *	2/1993	Banks A63B 21/06	D852,907	S *	7/2019	Sergakis D21/686
			482/104	D853,587	S	7/2019	Jackson et al.
5,273,506	A	12/1993	Dawson, Jr.	D853,588	S	7/2019	Jackson et al.
D344,601	S	2/1994	Jenkins et al.	D853,589	S	7/2019	Jackson et al.
5,290,209	A	3/1994	Wilkinson	D857,241	S	8/2019	Sakamoto et al.
5,306,220	A *	4/1994	Kearney A63B 23/00	2001/0034289	A1 *	10/2001	Parrillo A63B 23/035
			482/104				482/94
D355,005	S	1/1995	Voohanel, Jr.	2002/0082145	A1	6/2002	Hamilton
D358,623	S *	5/1995	Macasieb D21/691	2003/0222041	A1	12/2003	Hong et al.
5,669,859	A *	9/1997	Liggett A63B 21/078	2005/0130806	A1	6/2005	Lopez
			482/94	2006/0003875	A1 *	1/2006	Sharps A63B 21/0608
							482/100
5,776,033	A	7/1998	Brown	2006/0065800	A1	3/2006	Bremmon
D408,480	S *	4/1999	Haugo D21/691	2006/0145038	A1	7/2006	Chen
6,116,550	A	9/2000	Forbes	2007/0072750	A1 *	3/2007	Andrews A63B 21/078
6,129,651	A	10/2000	Denaro				482/104
D486,020	S	2/2004	Hoernig	2007/0203002	A1 *	8/2007	Webber A63B 21/078
D486,337	S	2/2004	Hoernig				482/104
D514,857	S	2/2006	Hoernig	2009/0105052	A1	4/2009	Dalebout et al.
D525,668	S	7/2006	Payne	2009/0124471	A1	5/2009	Storch
7,316,379	B1	1/2008	Graham	2010/0044536	A1	2/2010	Huang
7,374,516	B2 *	5/2008	Lundquist A63B 21/078	2010/0048368	A1	2/2010	Donofrio
			482/104	2010/0171017	A1	7/2010	Chang
7,523,907	B2	4/2009	Chen	2012/0094812	A1	4/2012	Smiley
D593,169	S	5/2009	Storch	2012/0329614	A1 *	12/2012	Schiano A63B 21/078
7,534,200	B1 *	5/2009	Martinez A63B 21/00047				482/104
			482/142	2013/0237394	A1	9/2013	Fowler
7,549,950	B1 *	6/2009	Lundquist A63B 21/078	2013/0260970	A1	10/2013	Moskowich
			482/101	2013/0296143	A1 *	11/2013	Staten A63B 21/0618
7,892,158	B2	2/2011	Varga				482/98
D635,206	S *	3/2011	Henniger D21/691	2014/0166834	A1	6/2014	Kuroyanagi et al.
D636,038	S *	4/2011	Henniger D21/691	2014/0256517	A1 *	9/2014	Poppinga A63B 21/078
D636,039	S *	4/2011	Henniger D21/691				482/104
D636,040	S *	4/2011	Henniger D21/691	2014/0371040	A1	12/2014	Vasquez et al.
8,047,972	B1 *	11/2011	Dean A63B 1/005	2015/0016919	A1 *	1/2015	Tambornino F16B 35/06
			482/104				411/366.1
8,079,915	B2	12/2011	Spencer et al.	2015/0059257	A1	3/2015	Beaver et al.
D659,854	S	5/2012	Kligman	2015/0065316	A1 *	3/2015	Towley, III A63B 21/00047
D661,412	S	6/2012	Kligman				482/104
8,323,158	B2 *	12/2012	Keiser A63B 21/0087	2015/0069257	A1	3/2015	Besson
			482/104	2015/0076092	A1 *	3/2015	Tambornino A63B 21/078
8,328,698	B1 *	12/2012	Webber A63B 21/078				211/85.7
			482/104	2015/0126335	A1	5/2015	Gilson et al.
D682,955	S	5/2013	Stephan	2015/0202485	A1 *	7/2015	Towley, III A63B 23/1209
8,500,608	B1 *	8/2013	Bonomi A63B 21/075				482/104
			482/101	2015/0264823	A1	9/2015	Shirley et al.
8,517,900	B1 *	8/2013	Britt A63B 21/0724	2015/0290488	A1	10/2015	Hopperstad et al.
			482/104	2016/0023035	A1 *	1/2016	Meyer A63B 1/00
D703,773	S	4/2014	Henry				482/38
D711,021	S	8/2014	Singh	2016/0250515	A1	9/2016	Hopperstad et al.
8,992,395	B2	3/2015	Orakwusi	2016/0338512	A1	11/2016	Royak
9,011,298	B2 *	4/2015	Bonomi A63B 21/0414	2016/0339291	A1	11/2016	Hopperstad et al.
			482/101	2017/0065844	A1	3/2017	Hopperstad et al.
9,044,629	B2	6/2015	Ross	2017/0072260	A1	3/2017	Jackson
D734,410	S	7/2015	Childs et al.	2017/0189736	A1	7/2017	Martin
D735,820	S *	8/2015	Alenaddaf D21/686	2017/0209733	A1	7/2017	Beaver et al.
D735,821	S *	8/2015	Alenaddaf D21/686	2017/0239512	A1	8/2017	Brasch et al.
D742,540	S	11/2015	Singh	2017/0246490	A1	8/2017	Hopperstad et al.
D742,543	S	11/2015	Singh	2017/0246496	A1 *	8/2017	Nelson A63B 21/4035
9,192,799	B2	11/2015	Alenaddaf	2018/0028852	A1 *	2/2018	Beaver A63B 71/0036
9,308,410	B2	4/2016	Beaver et al.	2018/0036573	A1 *	2/2018	Lennox A63B 21/4035
D757,531	S	5/2016	Rusher	2018/0056108	A1 *	3/2018	Kelly F16M 13/022
9,333,387	B2	5/2016	Hopperstad et al.	2018/0056116	A1	3/2018	Le Nguyen
D764,607	S	8/2016	Beckford et al.	2018/0104522	A1	4/2018	Hopperstad et al.
9,409,048	B1	8/2016	Hopperstad et al.	2018/0117382	A1 *	5/2018	Johanson A63B 21/00047
9,492,701	B1 *	11/2016	Bognatz A63B 21/072	2018/0142832	A1	5/2018	Inouye
			482/104	2018/0153305	A1	6/2018	Haines
9,498,670	B1	11/2016	Hopperstad et al.	2018/0154234	A1	6/2018	Pack et al.
9,517,382	B2	12/2016	Payne	2018/0178051	A1	6/2018	Shaw, Jr.
9,649,525	B2	5/2017	Hopperstad et al.	2018/0185694	A1 *	7/2018	Schween A63B 21/078
9,675,829	B1	6/2017	Katz	2018/0243597	A1 *	8/2018	Schlegel A63B 69/345
9,700,761	B2	7/2017	Beaver et al.	2018/0318635	A1 *	11/2018	Lee A63B 21/078
				2018/0326250	A1 *	11/2018	Henniger A63B 21/068
				2019/0046835	A1 *	2/2019	Henniger A63B 23/1218

(56)

References Cited

U.S. PATENT DOCUMENTS

2019/0126088 A1* 5/2019 Henniger A63B 21/068
2019/0240521 A1* 8/2019 Staten A63B 23/1218
2019/0269992 A1* 9/2019 Dunahay A47F 5/101

OTHER PUBLICATIONS

Jan. 11, 2019—(WO) ISR and WO—App No. PCT/US2018/059018.

Rogue product advertisement dated Dec. 3, 2015 (redacted).

Rogue fitness product video screenshots from <<https://www.youtube.com/watch?v=TRpmZ68p5Hw>>, dated Sep. 19, 2017.

Gorila Fitness product advertisement dated Apr. 16, 2018 (redacted).

Bulldog Gear product advertisement dated Jan. 11, 2018.

Pure Strength product listing dated Sep. 6, 2018 from <<https://www.pure-strength.com/collections/slim-gym-utility-plate>>.

Titan Fitness product listing dated Sep. 6, 2018 from <<https://www.titan.fitness/t-3-folding-power-rack-stringers.html>>.

Titan Fitness product listing dated Sep. 6, 2018 from <<https://www.titan.fitness/41-inch-deep-folding-wall-mount-rack.html>> (product known to be available as of Mar. 2, 2016).

* cited by examiner

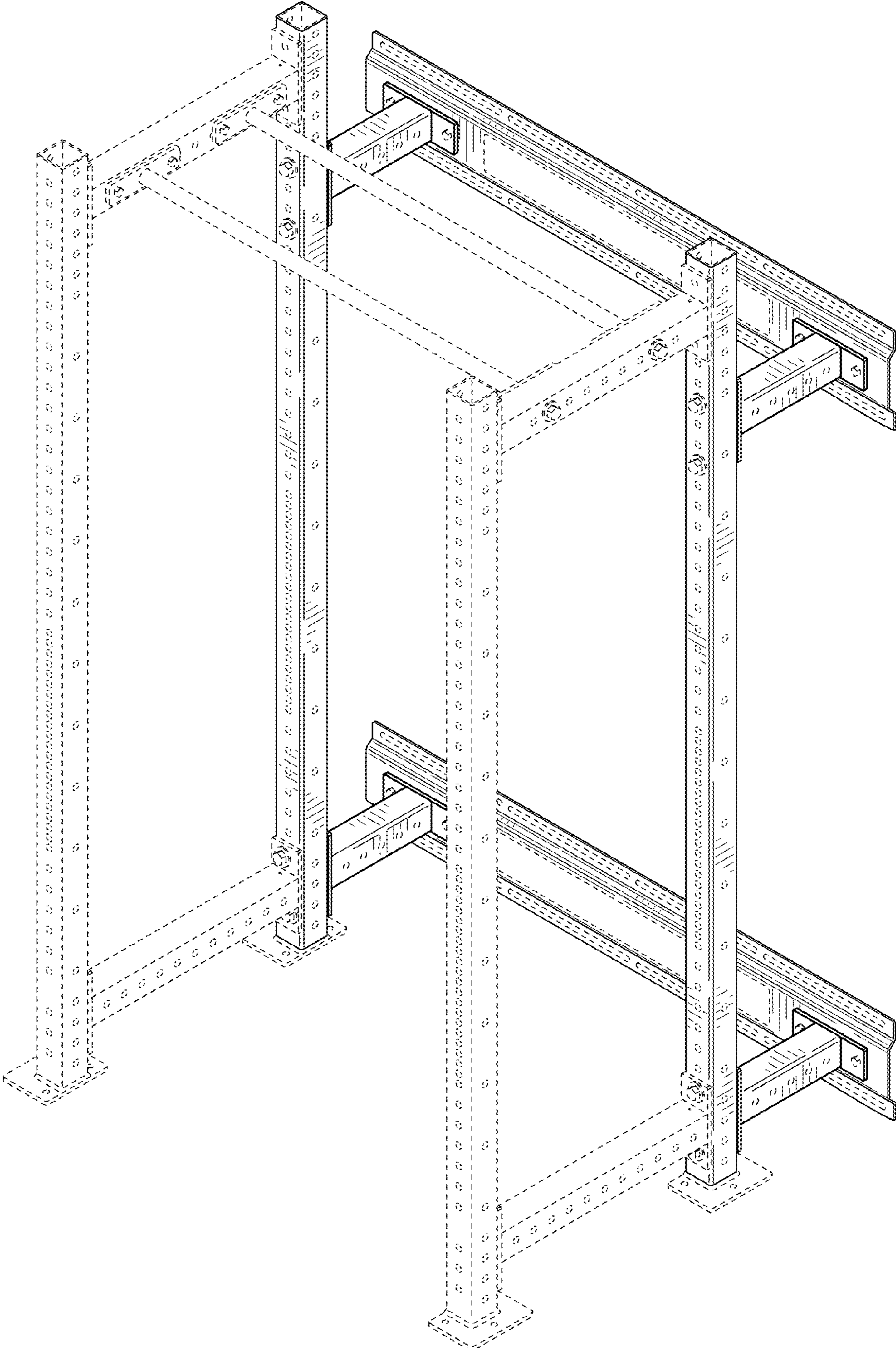

FIG. 1

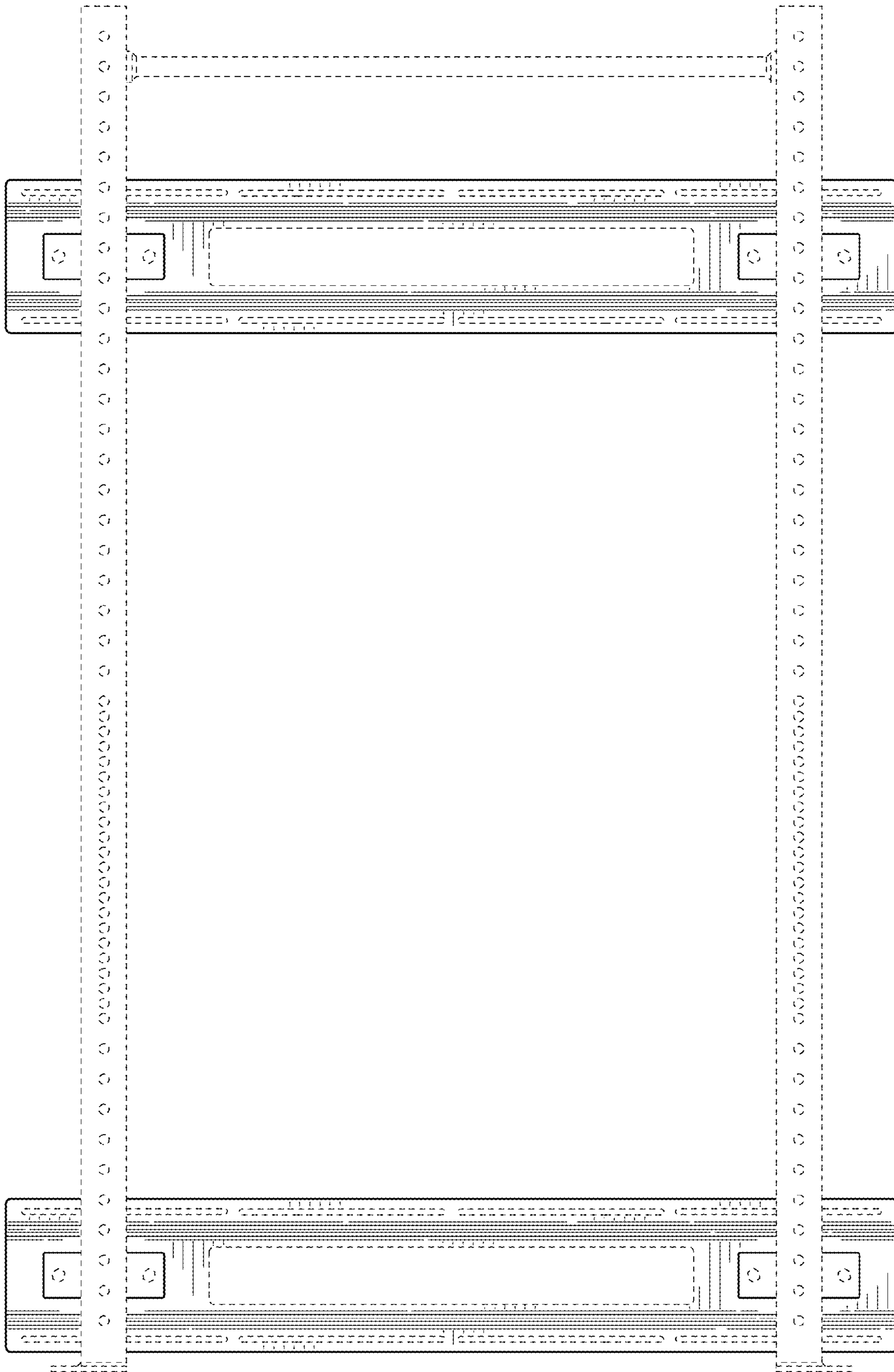

FIG. 2

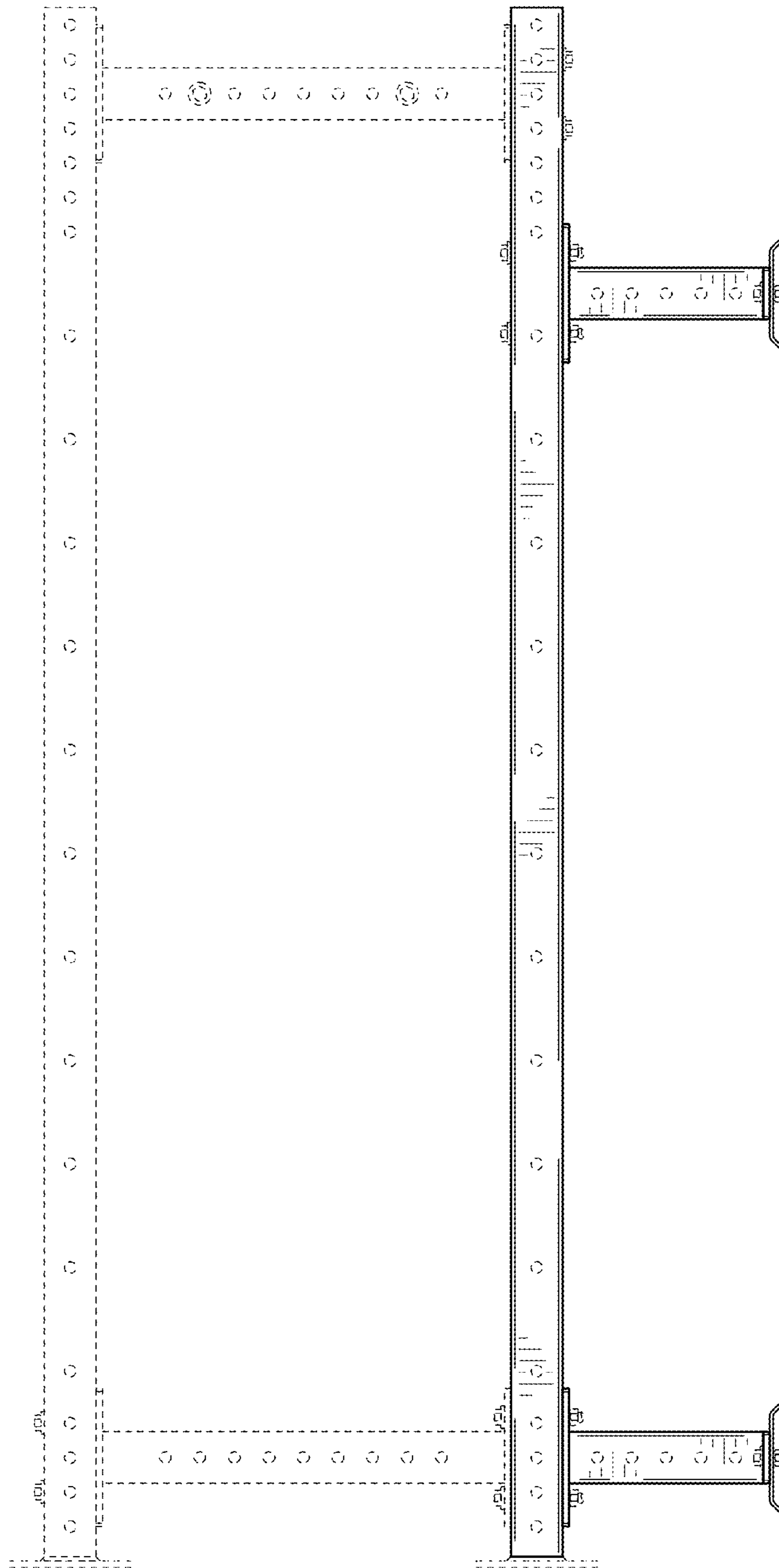

FIG. 3

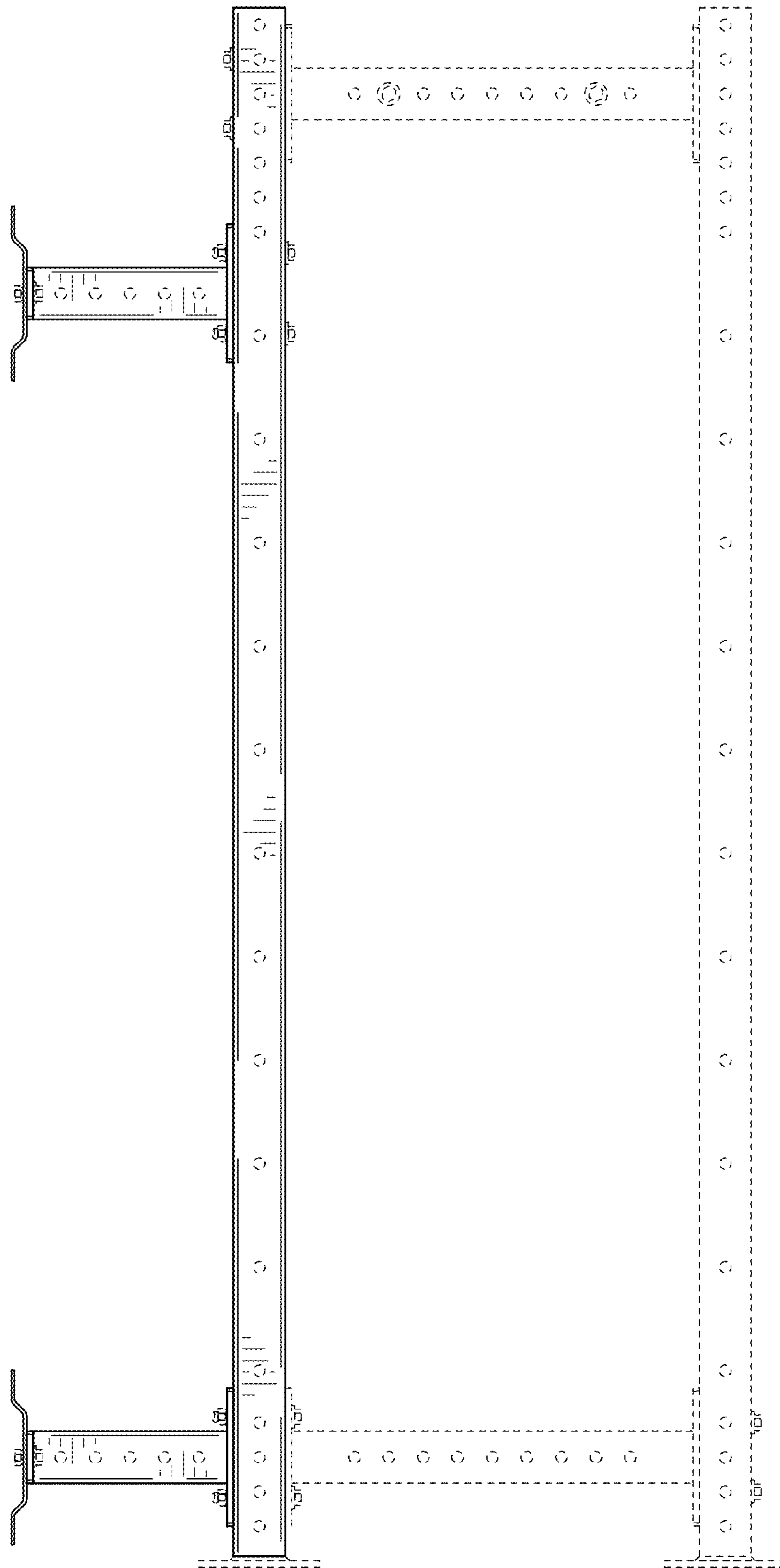

FIG. 4

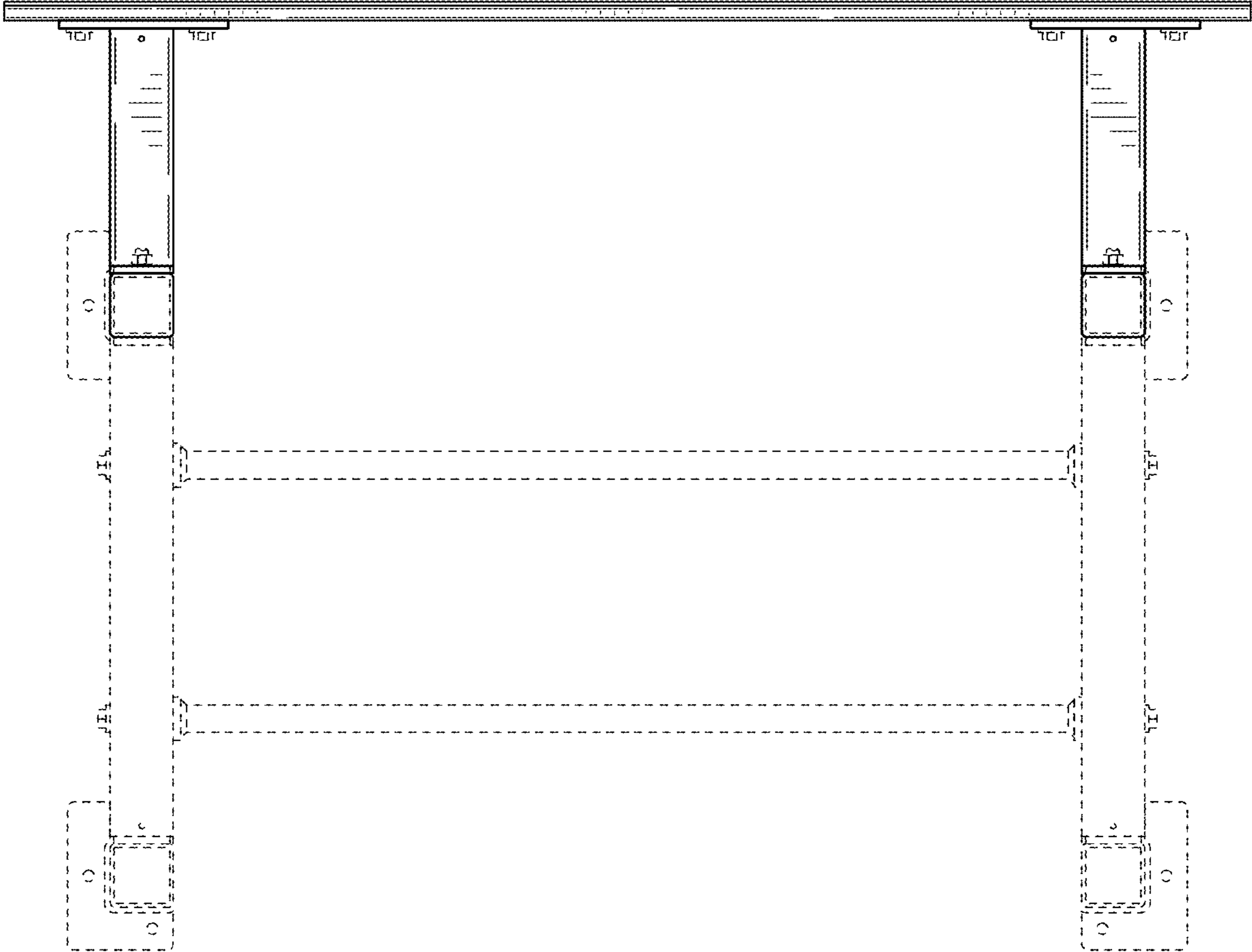

FIG. 5

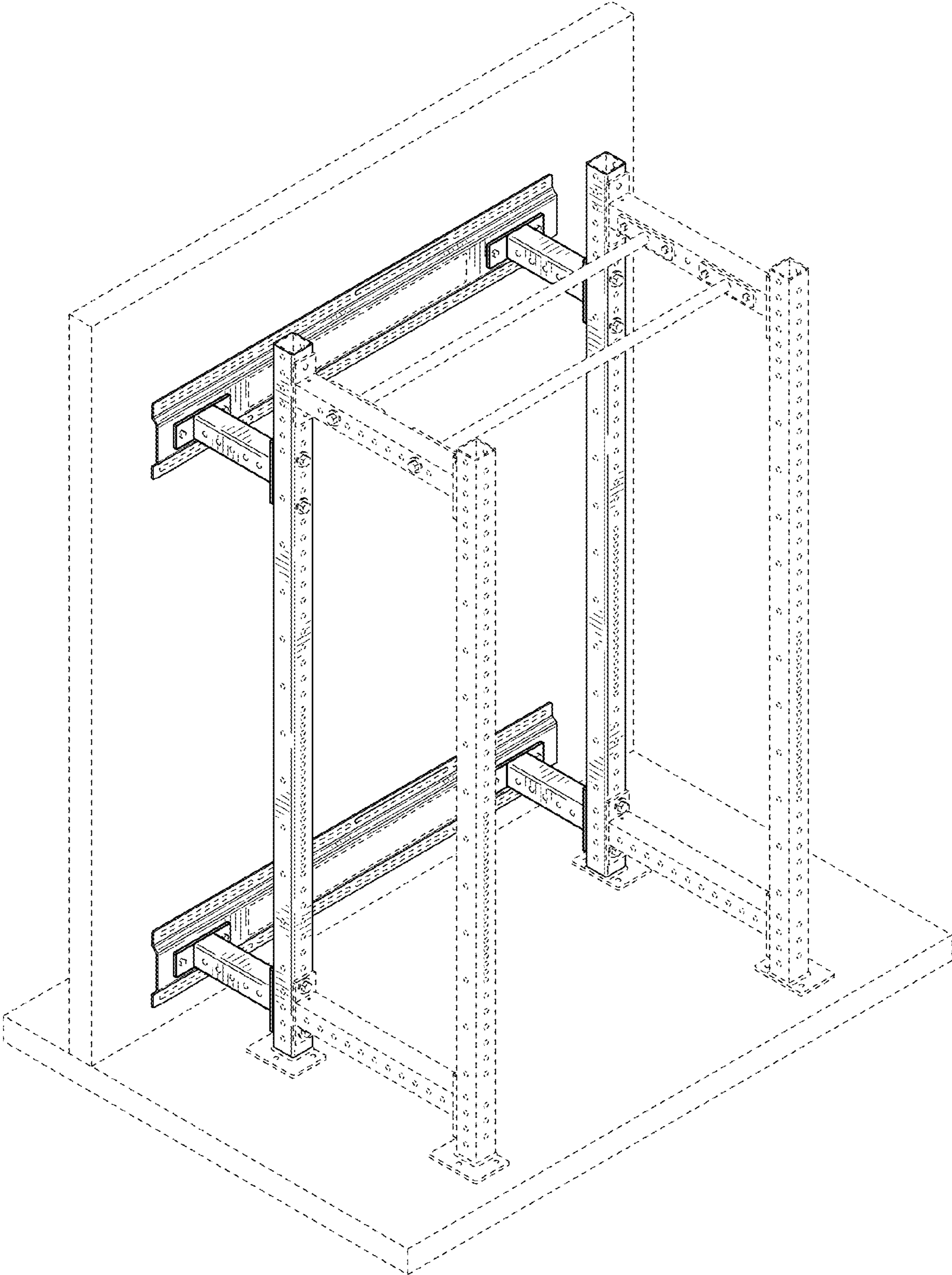

FIG. 6