



US00D888712S

(12) **United States Design Patent** (10) **Patent No.:** **US D888,712 S**
Tabata et al. (45) **Date of Patent:** **** Jun. 30, 2020**

(54) **WIRELESS COMMUNICATION DEVICE**

(56) **References Cited**

(71) Applicant: **YOKOGAWA ELECTRIC CORPORATION**, Musashino-shi, Tokyo (JP)

U.S. PATENT DOCUMENTS

- D214,706 S * 7/1969 Kauffman D10/114.2
- D237,369 S * 10/1975 Lowndes D10/114.8
- D239,517 S * 4/1976 Lowndes D10/114.8
- D242,942 S * 1/1977 Brudy D10/111
- D286,988 S * 12/1986 Akiyama D10/114.8
- D327,691 S * 7/1992 Ogawa D14/230
- D333,661 S * 3/1993 Elliott D14/236

(Continued)

(72) Inventors: **Hiroki Tabata**, Musashino (JP); **Naoto takano**, Musashino (JP); **Mitsuhiro Kamiya**, Musashino (JP); **Takuya Nidaira**, Musashino (JP); **Keiichi Sasaki**, Musashino (JP)

OTHER PUBLICATIONS

Sushi Sensor Series of Temperature and Pressure Sensors for Industrial IoT . (online pdf) 6 pg. 2019. [retrieved Mar. 31, 2020] <https://web-material3.yokogawa.com/1/29092/files/rd-te-r06202-003.pdf>.*

(Continued)

(73) Assignee: **Yokogawa Electric Corporation**, Tokyo (JP)

Primary Examiner — Marie D. Fast Horse

(**) Term: **15 Years**

(74) *Attorney, Agent, or Firm* — Sughrue Mion, PLLC

(21) Appl. No.: **29/683,943**

(22) Filed: **Mar. 18, 2019**

(51) **LOC (12) Cl.** **14-02**

(52) **U.S. Cl.**
USPC **D14/358**

(58) **Field of Classification Search**
USPC D14/140, 140.1, 140.2, 140.3, 140.4, D14/140.5, 140.6, 142, 155, 168, 230, D14/233, 240, 242, 243, 255, 299, 496, D14/356, 358, 236, 137; D13/123, 152, D13/154, 158, 184, 199, 101, 110, 111, D13/112, 114, 160; D10/46, 75, 103, D10/104.1, 121, 106.1, 106.6, 106.3, D10/109.1, 109.2, 111, 114.1, 114.2, D10/114.6, 114.8, 83, 53, 78
CPC H04W 88/00; H04W 88/02; H04W 88/08; H04W 16/24; H04W 8/245; H04W 84/042; H04W 84/045; H04W 84/047; H04W 84/18; H04M 1/72522; H04M 1/72525; H04L 29/08558; G01G 1/00; G01G 5/00; H04B 1/082

See application file for complete search history.

(57) **CLAIM**

The ornamental design for a wireless communication device, as shown and described.

DESCRIPTION

FIG. 1 is a perspective view of front, top and right side view of a wireless communication device showing our new design;
FIG. 2 is a perspective view of rear, bottom and left side view thereof;
FIG. 3 is a front view thereof;
FIG. 4 is a rear view thereof;
FIG. 5 is a left side view thereof;
FIG. 6 is a right side view thereof;
FIG. 7 is a top view thereof; and,
FIG. 8 is a bottom view thereof.
The broken lines in the drawings depict portions of the wireless communication device that form no part of the claimed design.

1 Claim, 8 Drawing Sheets

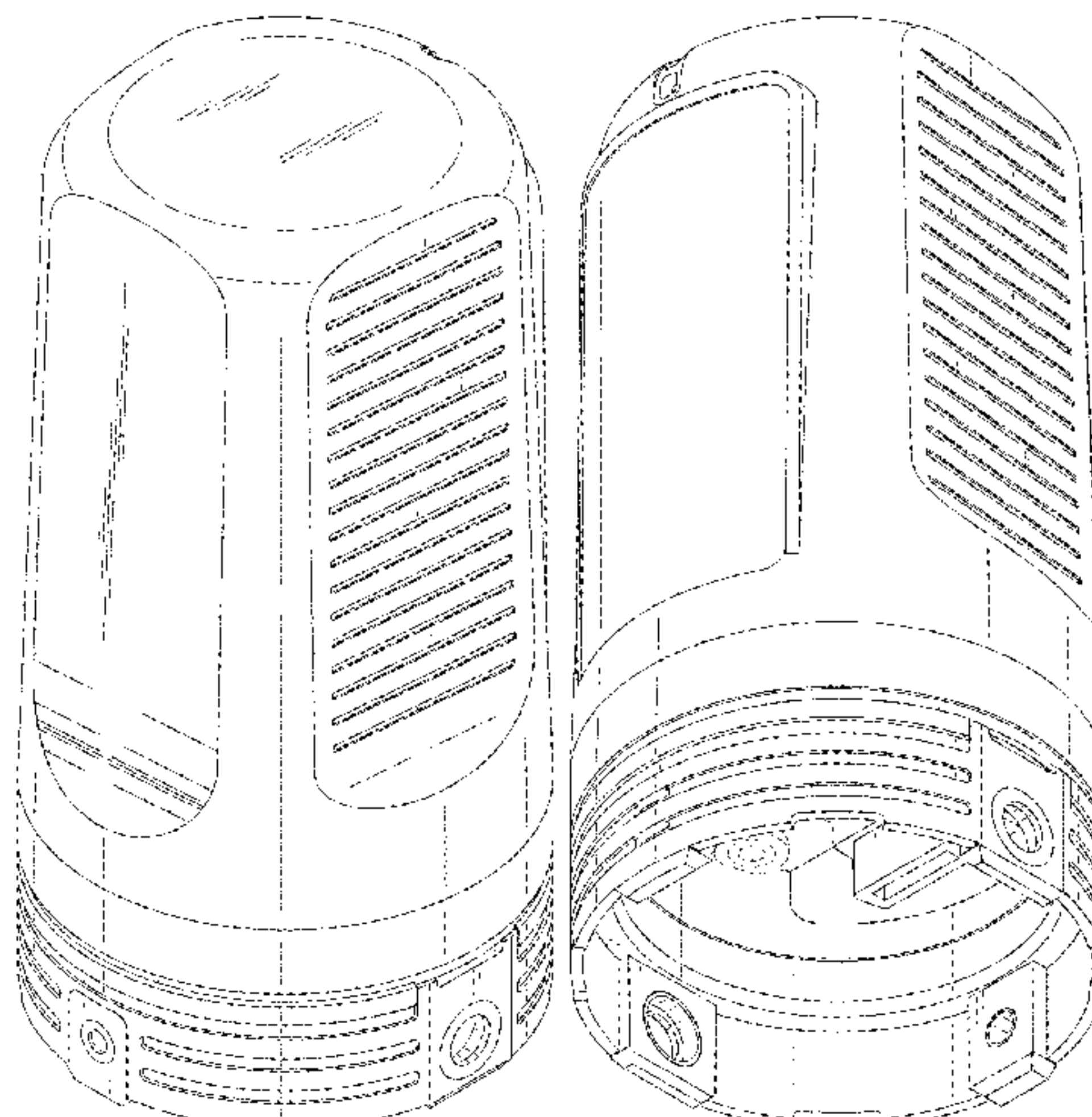

(56)

References Cited

U.S. PATENT DOCUMENTS

D347,436 S * 5/1994 Tang D14/230
 D349,256 S * 8/1994 Bellinger D10/114.2
 D390,566 S * 2/1998 Martek D14/230
 D402,991 S * 12/1998 Mosser D14/230
 D411,640 S * 6/1999 Lueken D10/113.1
 D412,676 S * 8/1999 Layes D10/106.6
 D436,101 S * 1/2001 McGovern D14/140.5
 D437,243 S * 2/2001 Cessac D10/104.1
 D440,890 S * 4/2001 Warner D10/78
 D442,947 S * 5/2001 Warner D14/230
 D457,518 S * 5/2002 Wilson D14/230
 D462,070 S * 8/2002 Wilson D14/233
 D462,675 S * 9/2002 Kusz D14/140.6
 D468,731 S * 1/2003 Wilson D14/234
 D486,146 S * 2/2004 Dearnley D14/230
 D493,447 S * 7/2004 Noro D14/230
 D513,477 S * 1/2006 Heftman D10/111
 D519,860 S * 5/2006 Bugbee D10/47
 D544,805 S * 6/2007 Corrigan D10/111
 D550,659 S * 9/2007 Noro D14/230
 D566,698 S * 4/2008 Choi D14/240
 D570,722 S * 6/2008 Taylor D10/114.8
 7,406,298 B2 * 7/2008 Luglio H04B 1/38
 340/500
 D586,810 S * 2/2009 Hershey D14/358
 D587,268 S * 2/2009 Hershey D14/358
 D589,044 S * 3/2009 Yoshida D14/358
 D592,088 S * 5/2009 Miller D10/114.8
 D592,213 S * 5/2009 Hershey D14/358
 D592,650 S * 5/2009 Tsang D14/242
 D598,316 S * 8/2009 Kuwano D10/114.8
 D601,053 S * 9/2009 Ferrie D10/114.8
 D604,279 S * 11/2009 Chen D14/230
 D605,965 S * 12/2009 Jackson D10/109.1
 D608,232 S * 1/2010 Duran Neira D10/107
 D608,673 S * 1/2010 Arosio D10/111
 D612,760 S * 3/2010 Chen D10/114.8
 D616,777 S * 6/2010 Jackson D10/114.5
 D619,992 S * 7/2010 Wayman D14/140.5
 D621,812 S * 8/2010 Wayman D14/140.5
 D622,709 S * 8/2010 Hern D14/230
 D623,633 S * 9/2010 Bliss D14/233
 D624,448 S * 9/2010 Jackson D10/114.8
 D626,442 S * 11/2010 Jackson D10/114.8
 D634,308 S * 3/2011 Bliss D14/233
 D641,647 S * 7/2011 Wu D10/111
 D647,812 S * 11/2011 Kuwano D10/114.1
 D648,241 S * 11/2011 Kuwano D10/114.1
 D651,110 S * 12/2011 Kuwano D10/114.1
 D651,111 S * 12/2011 Kuwano D10/114.1
 D651,112 S * 12/2011 Kuwano D10/114.1
 D651,113 S * 12/2011 Kuwano D10/114.1
 D652,334 S * 1/2012 Kuwano D10/114.1
 D666,583 S * 9/2012 Le D14/230
 D668,982 S * 10/2012 Hsiao D10/114.2

D669,894 S * 10/2012 Cobbett D14/358
 D674,787 S * 1/2013 Tsuda D14/240
 D674,788 S * 1/2013 Tsuda D14/240
 D684,078 S * 6/2013 Clifford D10/114.2
 D692,783 S * 11/2013 Yumoto D10/53
 D694,740 S * 12/2013 Apostolakis D14/240
 D701,466 S * 3/2014 Clifford D10/114.2
 D706,152 S * 6/2014 Ni D10/106.6
 D709,782 S * 7/2014 Stuffle D10/114.1
 D713,092 S * 9/2014 Smith D26/118
 D725,098 S * 3/2015 Neumann D10/78
 D725,099 S * 3/2015 Neumann D10/78
 D728,540 S * 5/2015 Inoue D14/240
 D729,214 S * 5/2015 Beaudoin D14/230
 D733,107 S * 6/2015 Porter D14/240
 D748,773 S * 2/2016 Ritter, III D10/83
 D749,578 S * 2/2016 Takano D14/358
 D751,534 S * 3/2016 Lenz D14/230
 D757,588 S * 5/2016 Stuffle D10/114.1
 D768,626 S * 10/2016 Mikelson D14/300
 D772,206 S * 11/2016 Lasier D14/230
 D778,906 S * 2/2017 Grubel D10/101
 D801,335 S * 10/2017 Klingebiel D14/358
 D806,691 S * 1/2018 Andersson D14/240
 D813,230 S * 3/2018 Koo D14/358
 D833,312 S * 11/2018 Alonso D10/114.1
 D841,497 S * 2/2019 Blair D10/78
 D841,498 S * 2/2019 Blair D10/78
 D843,249 S * 3/2019 Blair D10/78
 D844,581 S * 4/2019 Zhou D14/142
 10,312,650 B2 * 6/2019 Siacotos H01R 33/96
 D854,434 S * 7/2019 Blair D10/78
 D854,953 S * 7/2019 Blair D10/78
 D854,954 S * 7/2019 Blair D10/78
 D865,541 S * 11/2019 Krishnamurthy D10/53
 D865,551 S * 11/2019 Tabata D10/83
 D867,319 S * 11/2019 Aaron D14/140.6
 D867,320 S * 11/2019 Aaron D14/140.6
 D867,321 S * 11/2019 Zimmerman, III D14/140.6
 D868,017 S * 11/2019 Aaron D14/140.6
 D868,755 S * 12/2019 Yang D14/230
 D875,705 S * 2/2020 Zimmerman, III D14/140.6
 D877,128 S * 3/2020 Senba D14/240
 D879,351 S * 3/2020 Deng D26/72
 2018/0045388 A1 * 2/2018 McDowell H02G 1/00
 2018/0172229 A1 * 6/2018 Lockwood H02S 30/20
 2018/0323503 A1 * 11/2018 Bouchard H01Q 1/42
 2020/0088390 A1 * 3/2020 Stegeman F21S 8/086

OTHER PUBLICATIONS

Radio data-transmission equipment and sensors. (Design—© Questel) orbit.com. [online PDF] 56 pgs. Print Dates range Jun. 21, 2019 through Feb. 28, 2020. [retrieved Mar. 31, 2020] <https://www.orbit.com/export/QPTUJ214/pdf2/bf455cb1-475e-4f6b-aed5-f3edec9ec160-223217.pdf>.*

* cited by examiner

FIG. 1

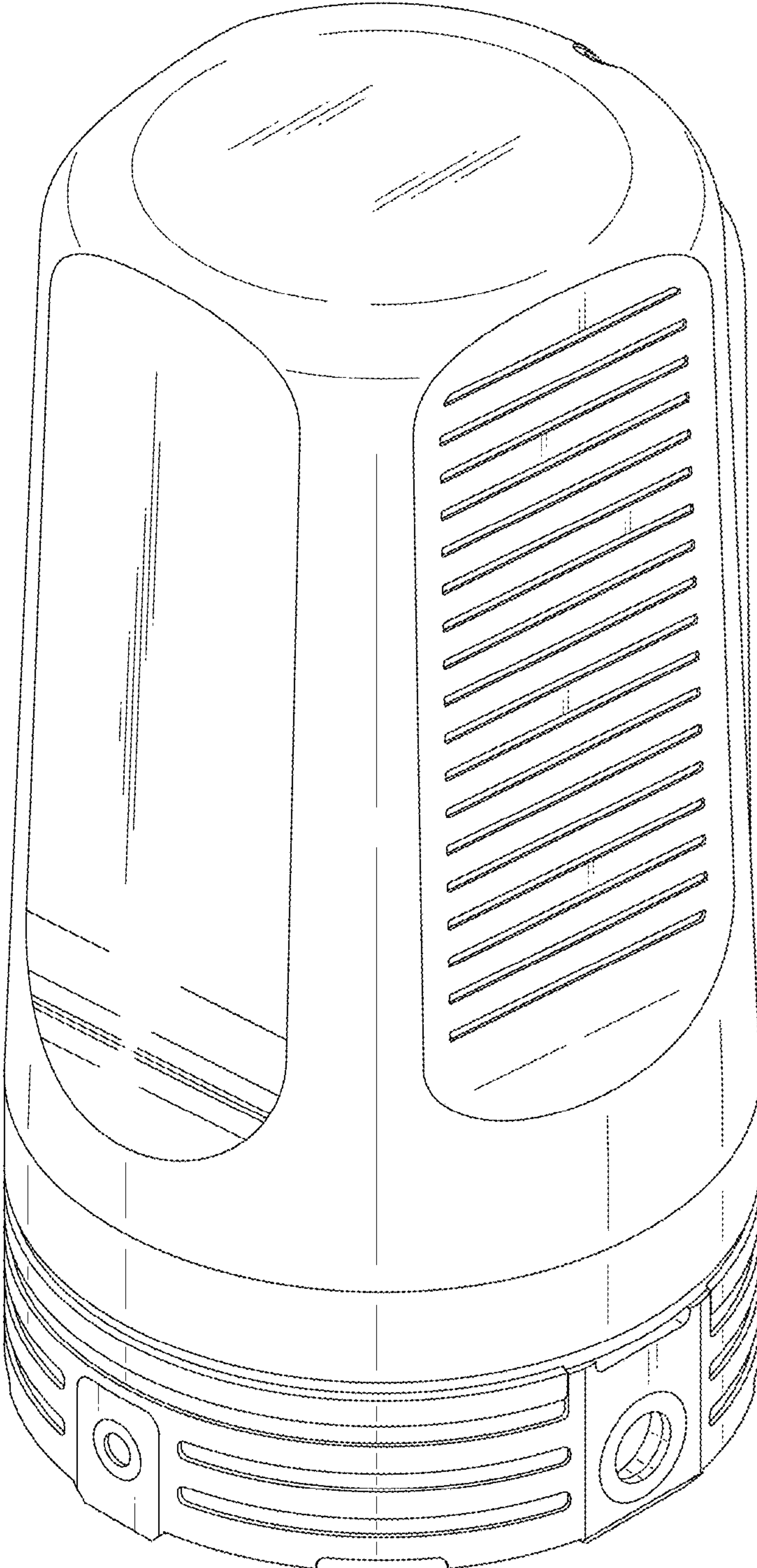

FIG. 2

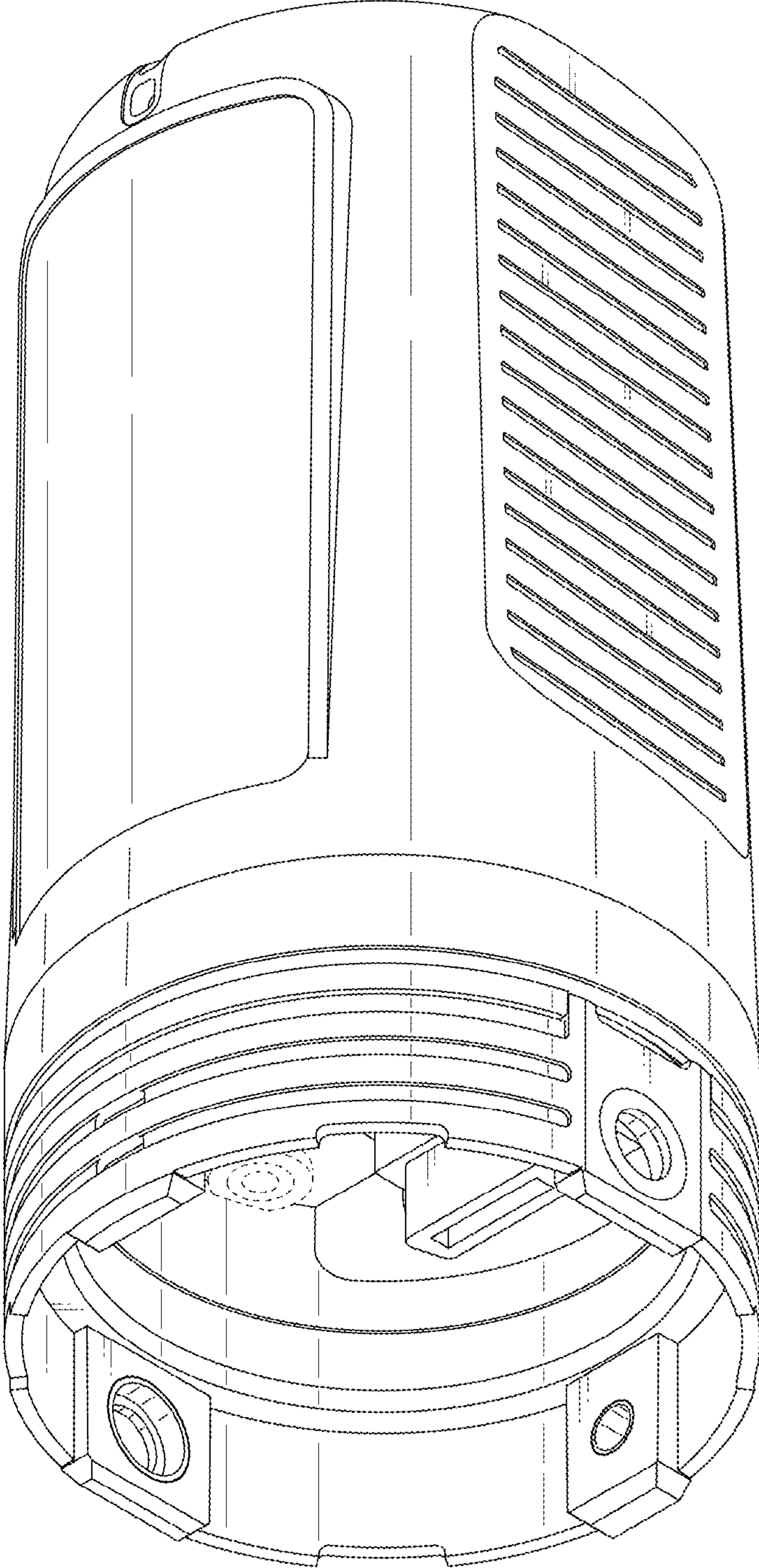

FIG. 3

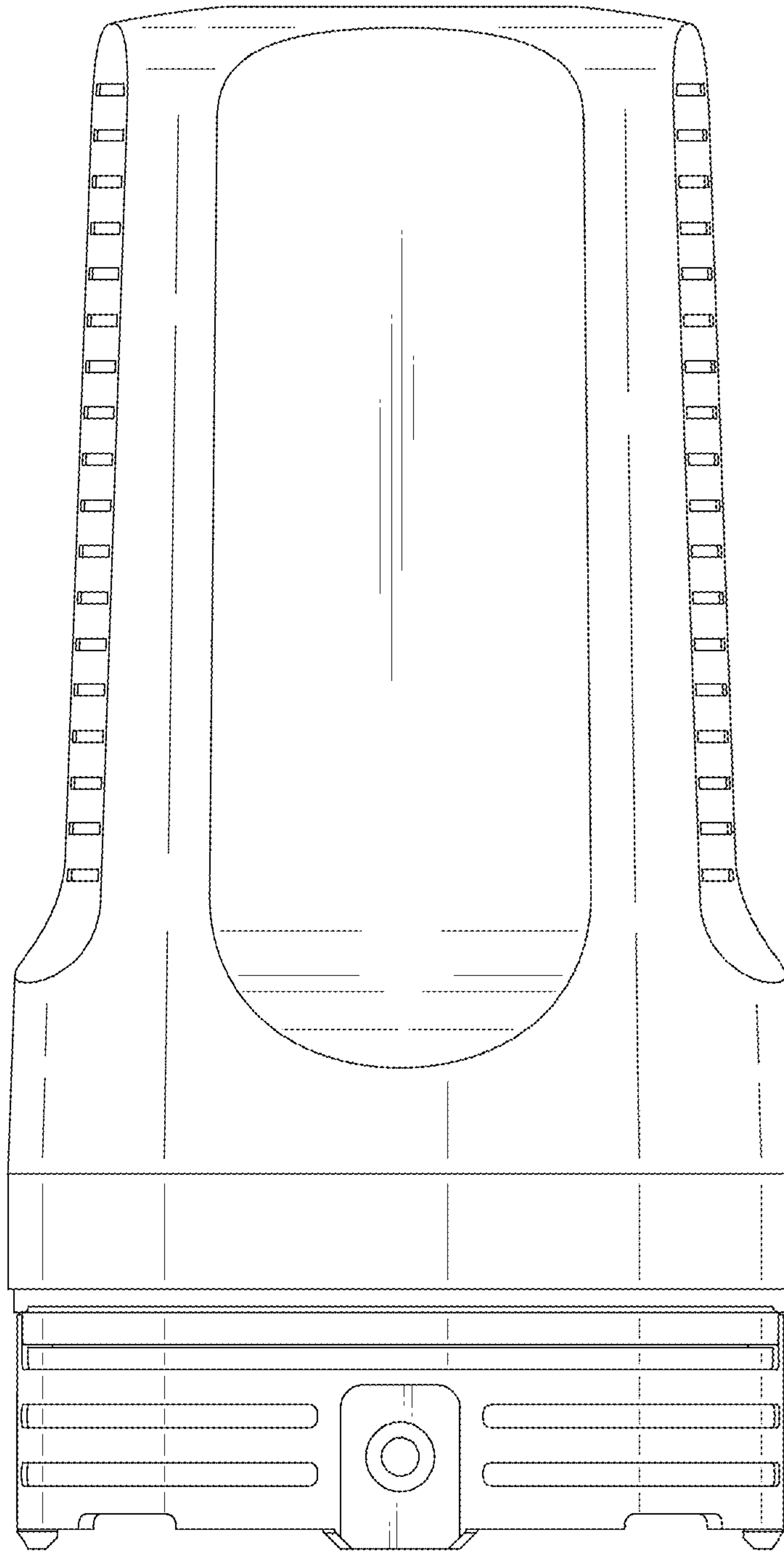

FIG. 4

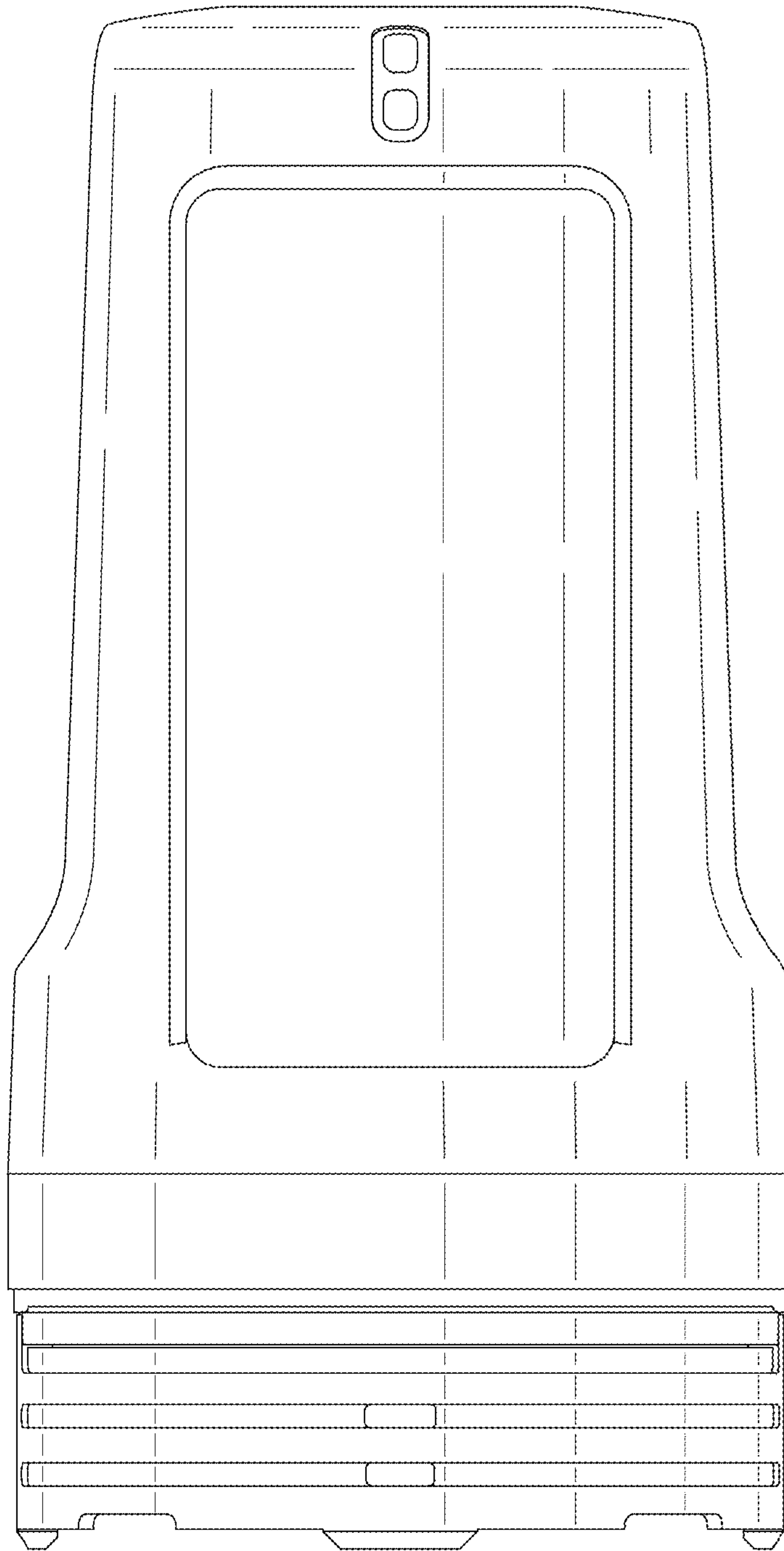

FIG. 5

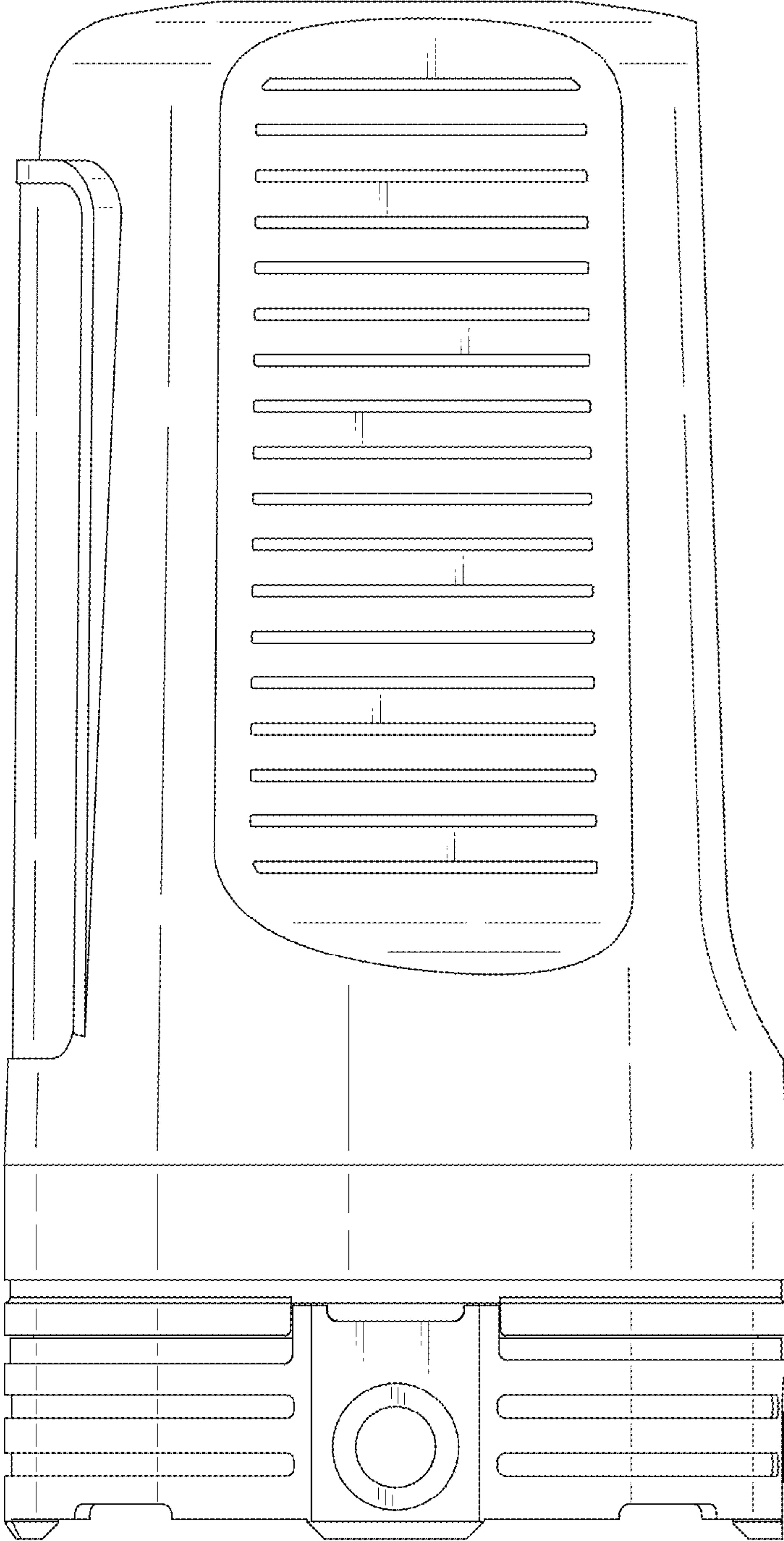

FIG. 6

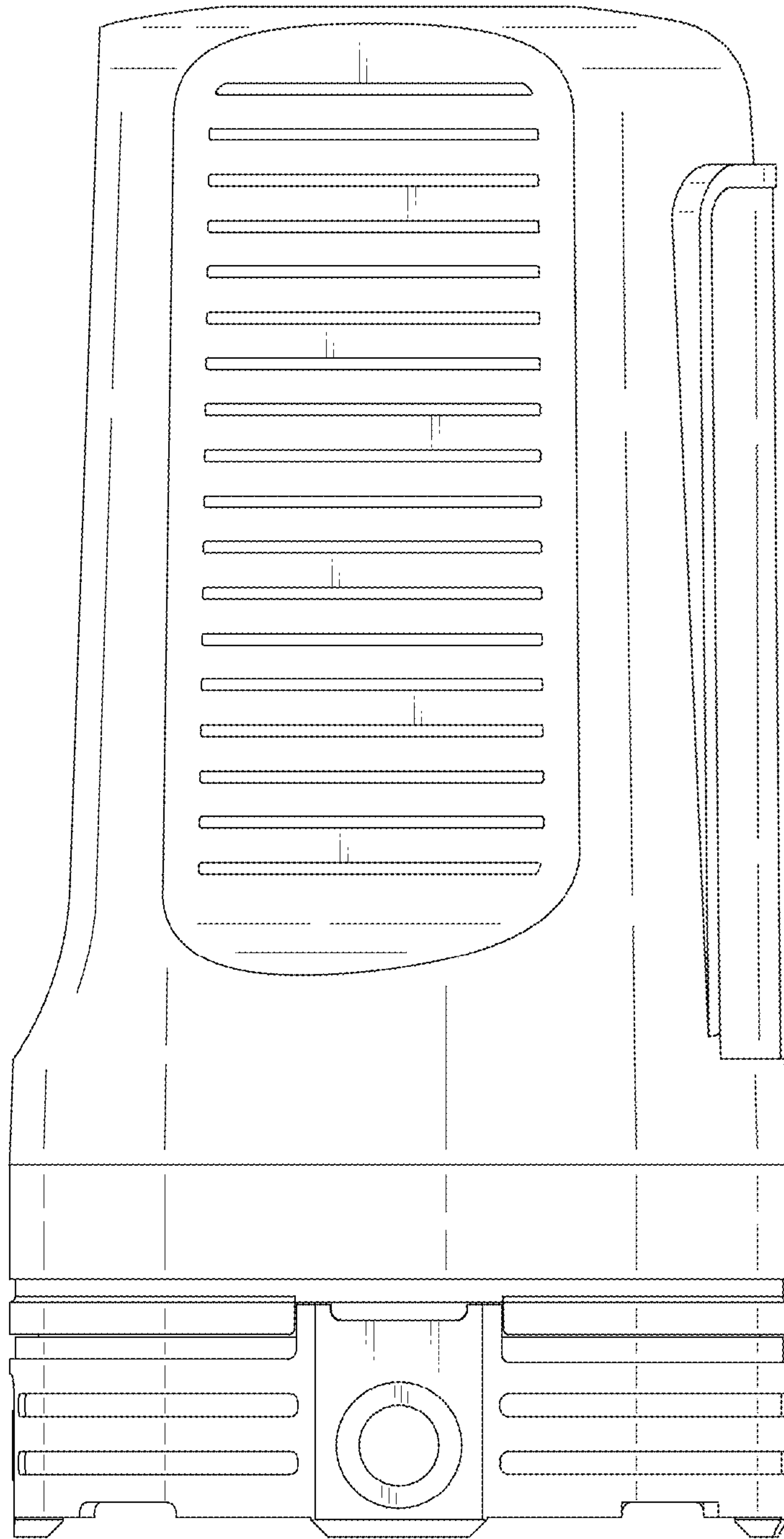

FIG. 7

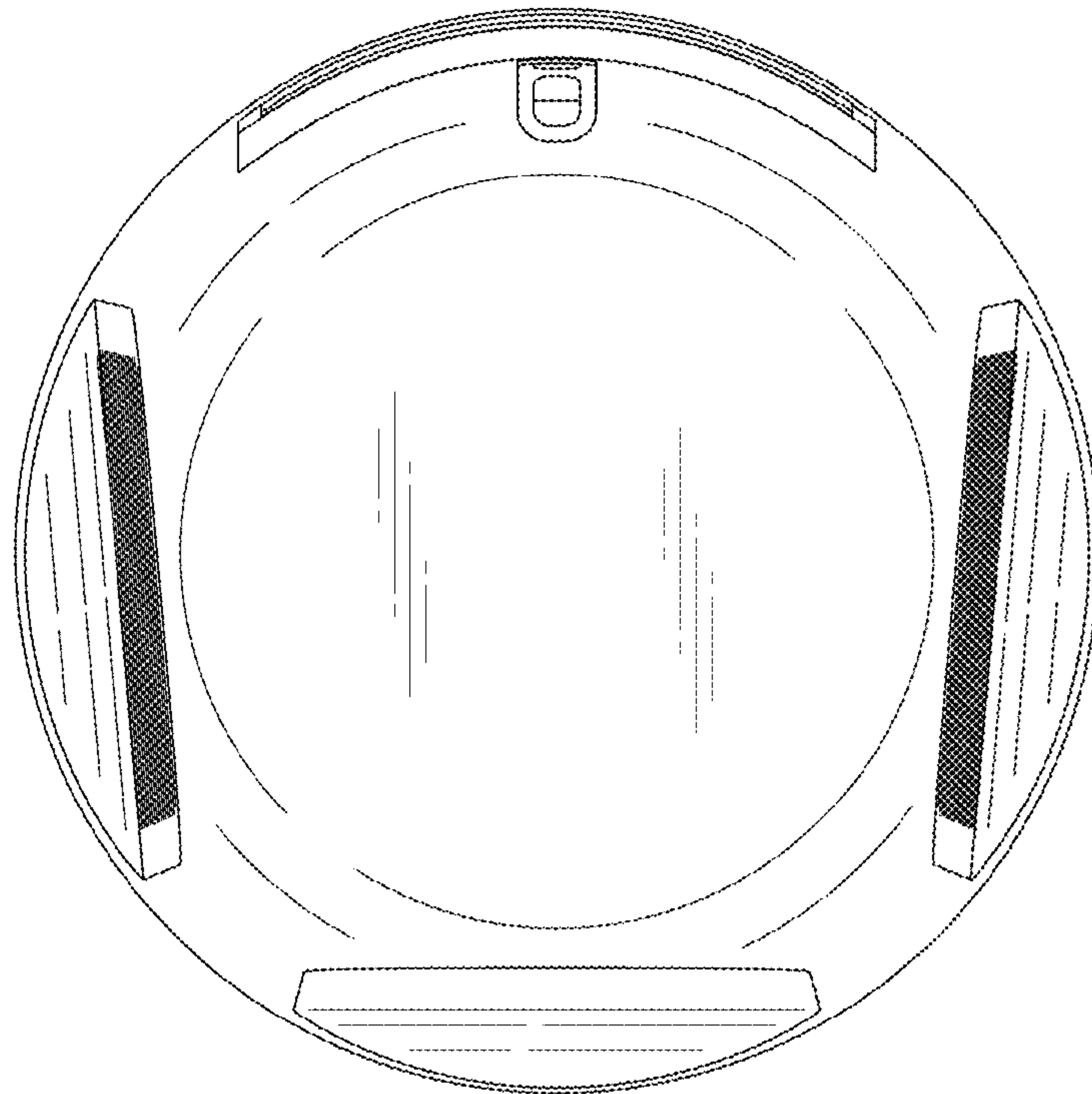

FIG. 8

