



US00D888562S

(12) **United States Design Patent**  
**Smith**

(10) **Patent No.:** **US D888,562 S**  
(45) **Date of Patent:** **\*\* Jun. 30, 2020**

(54) **CONTAINER**

*Primary Examiner* — Dana Meyrow

(71) Applicant: **Owens-Brockway Glass Container Inc.**, Perrysburg, OH (US)

(72) Inventor: **Taylor Smith**, Findlay, OH (US)

(73) Assignee: **Owens-Brockway Glass Container Inc.**, Perrysburg, OH (US)

(\*\*) Term: **15 Years**

(21) Appl. No.: **29/708,787**

(22) Filed: **Oct. 9, 2019**

(51) **LOC (12) Cl.** ..... **09-01**

(52) **U.S. Cl.**  
USPC ..... **D9/500**

(58) **Field of Classification Search**  
USPC ..... D9/434, 500, 502–505, 516, 530, 537,  
D9/539, 545, 549, 558, 715, 719,  
D9/763–764, 772, 776–780  
CPC ..... B65D 1/00; B65D 1/02; B65D 1/0223;  
B65D 23/00; B65D 81/00; B65D  
2501/00; B65D 2501/0009  
See application file for complete search history.

(56) **References Cited**

**U.S. PATENT DOCUMENTS**

1,582,681	A	*	4/1926	Hammer	.....	B65D 1/0246
						215/43
D77,103	S	*	12/1928	Koch	.....	D9/545
D78,628	S	*	5/1929	Kart	.....	D9/500
D81,520	S	*	7/1930	Bromiley	.....	D9/500
D101,879	S		11/1936	Leppke		
D117,266	S		10/1939	Gerhart		
D129,329	S		9/1941	Woodley		
D136,888	S	*	12/1943	Ganson	.....	D24/197
2,387,573	A	*	10/1945	Ganson	.....	A61J 11/02
						215/11.5
D195,698	S		7/1963	Heintze		
D217,847	S	*	6/1970	Jenkins et al.	.....	D9/500

(Continued)

(57) **CLAIM**

I claim the ornamental design for the container, as shown and described.

**DESCRIPTION**

FIG. 1 is an upper perspective view of a container in accordance with an embodiment of my new claimed design. FIG. 2 is a front elevational view of the container in FIG. 1, the left, right, and rear elevational views being substantially the same as the front elevational view.

FIG. 3 is a top view of the container in FIG. 1.

FIG. 4 is a bottom view of the container in FIG. 1.

FIG. 5 is an upper perspective view of a container in accordance with another embodiment of my new claimed design.

FIG. 6 is a front elevational view of the container in FIG. 5, the left, right, and rear elevational views being substantially the same as the front elevational view.

FIG. 7 is a top view of the container in FIG. 5; and,

FIG. 8 is a bottom view of the container in FIG. 5.

Dash-dash broken lines shown in the drawings illustrate portions of the container that form no part of the claimed design.

Dash-dot broken lines shown in the drawings represent boundaries of the claimed design and form no part of the claimed design.

The terms top, left, right, bottom, rear, side, and front are used for reference only and do not limit the claimed design. Shading lines shown in the drawings represent surface contours, or transparency, translucency, or opacity, and not surface ornamentation, and such lines, in and of themselves, are not part of the claimed design.

Portions of the container not shown in the drawings form no part of the claimed design.

**1 Claim, 2 Drawing Sheets**

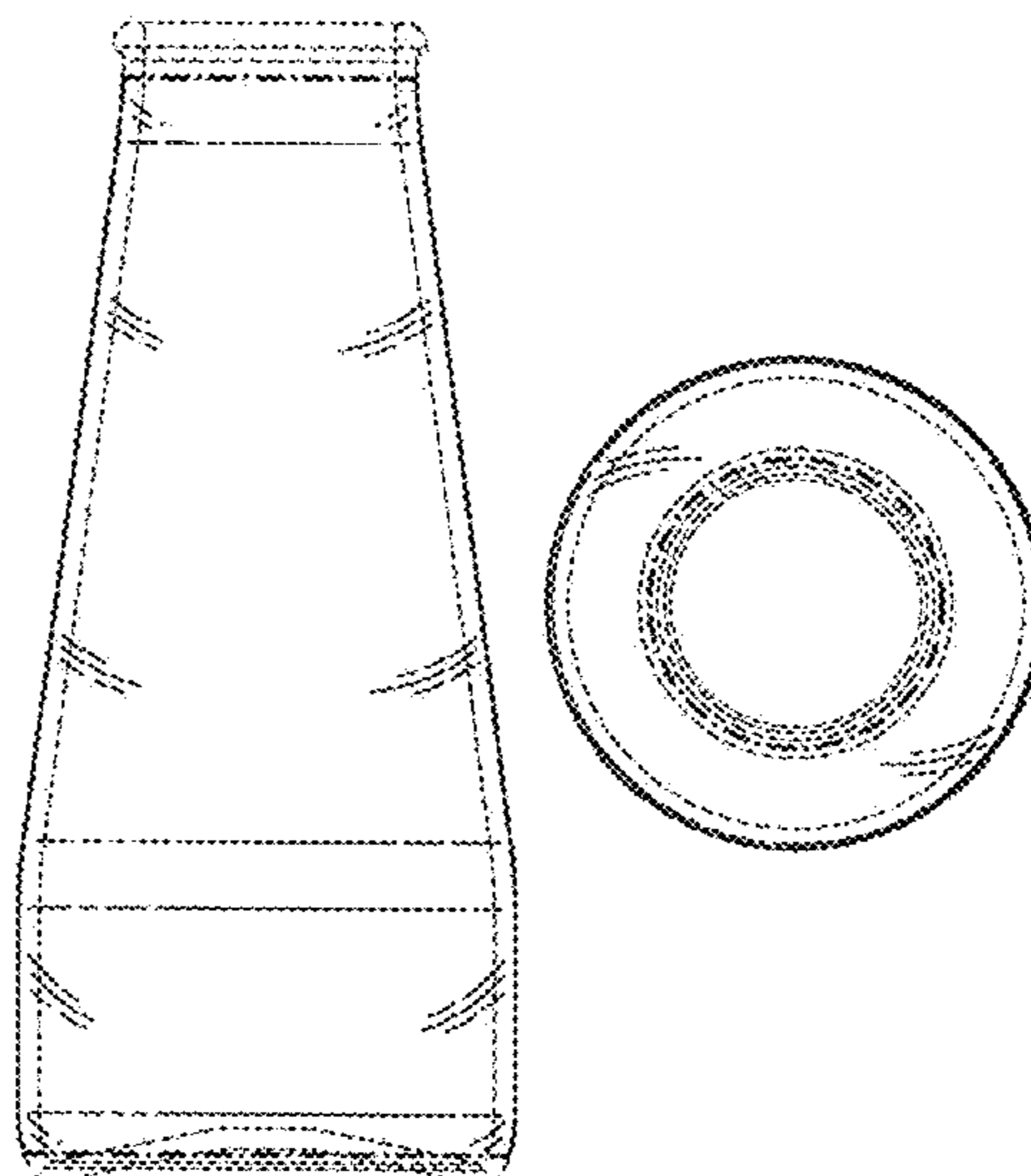

(56)

**References Cited**

## U.S. PATENT DOCUMENTS

D219,125	S	*	11/1970	Gortz .....	D9/691
D226,370	S	*	2/1973	Cromb .....	D9/500
D230,133	S	*	1/1974	Weckman .....	D9/500
D265,382	S	*	7/1982	Jonsson .....	D9/500
D281,399	S		11/1985	Fortuna	
D378,275	S		3/1997	Rusnock et al.	
D551,559	S		9/2007	Lepoitevin	
D586,660	S	*	2/2009	Morabito .....	D9/552
D592,062	S		5/2009	DaSilva et al.	
D596,942	S	*	7/2009	Britto .....	D9/500
D615,404	S	*	5/2010	Pitzer .....	D9/500
D635,463	S	*	4/2011	Passi .....	D9/435
D652,319	S	*	1/2012	Cohen .....	D9/691
D663,618	S		7/2012	Cohen et al.	
D702,131	S	*	4/2014	Handy .....	D9/691
D714,409	S		9/2014	Myers et al.	
D714,644	S		10/2014	Wagner et al.	
D731,893	S		6/2015	Chung	
D740,121	S		10/2015	Wagner et al.	
D745,398	S		12/2015	Cotton	
D758,206	S		6/2016	Hoeke et al.	
D772,070	S	*	11/2016	Broen .....	D9/415
D804,951	S		12/2017	Broen et al.	
D811,889	S		3/2018	Cheng	
D831,492	S		10/2018	Bram	
D832,709	S		11/2018	Cheng et al.	
D859,990	S	*	9/2019	Neset .....	D9/504

\* cited by examiner

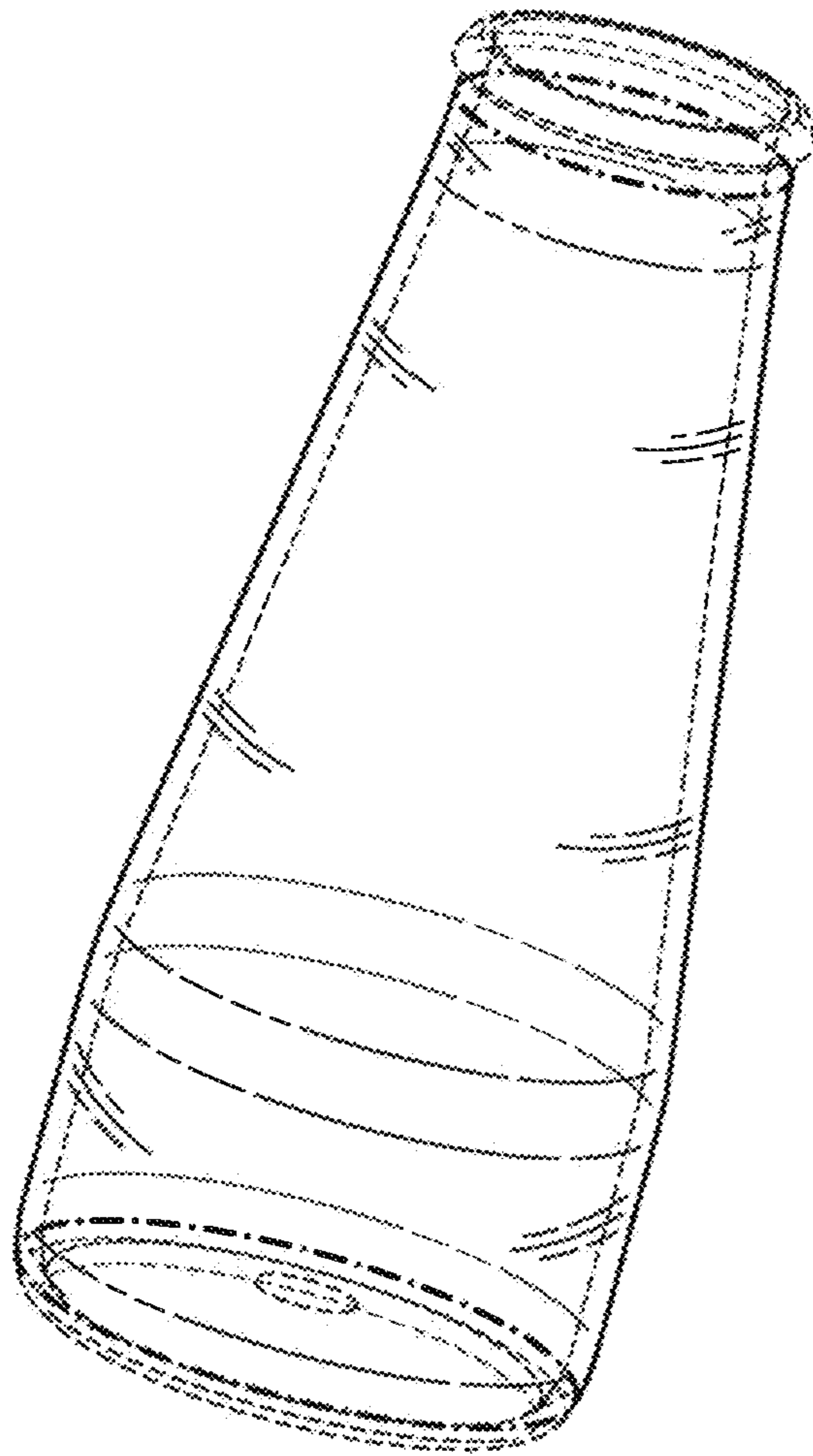

**FIG. 1**

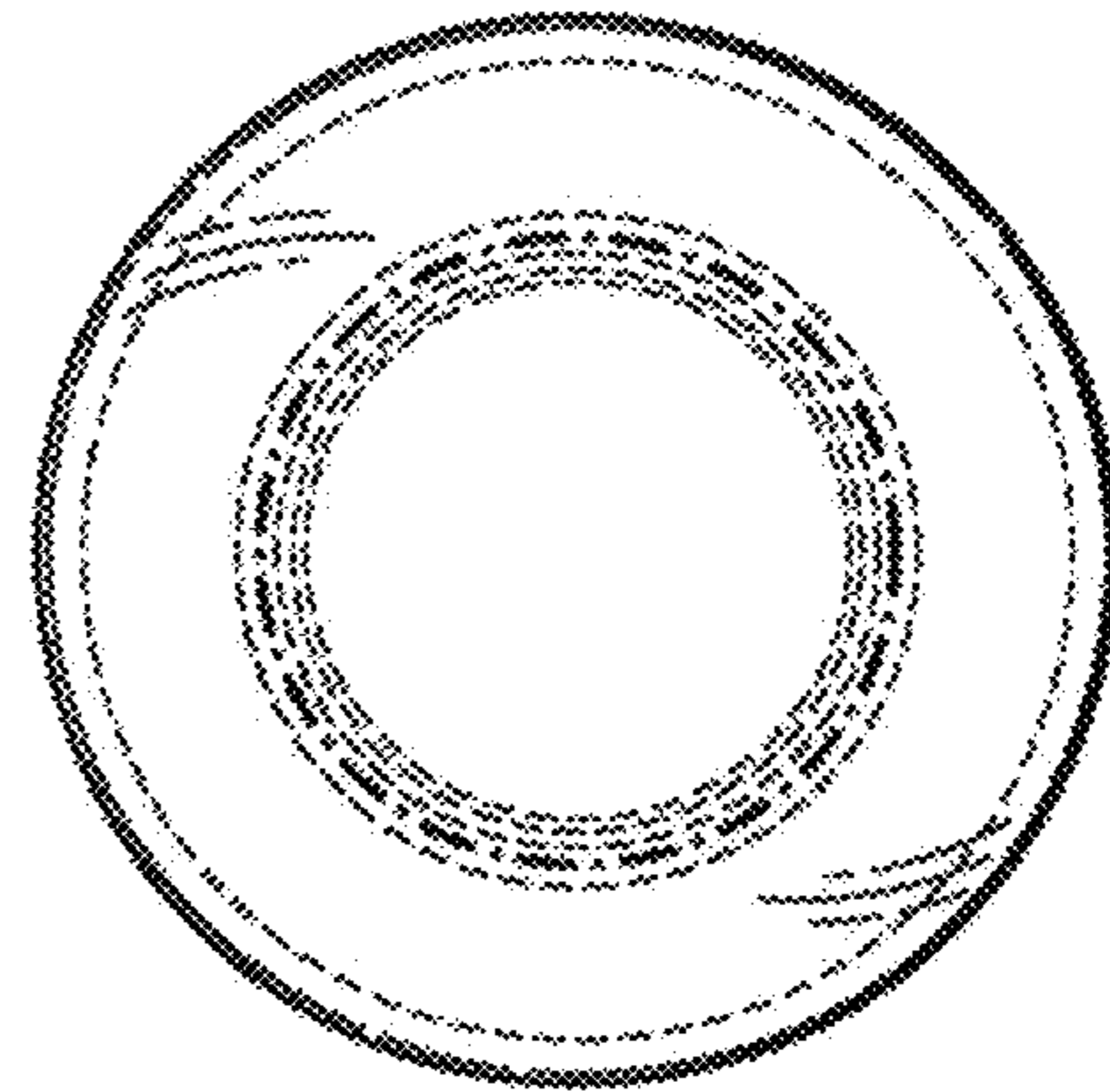

**FIG. 3**

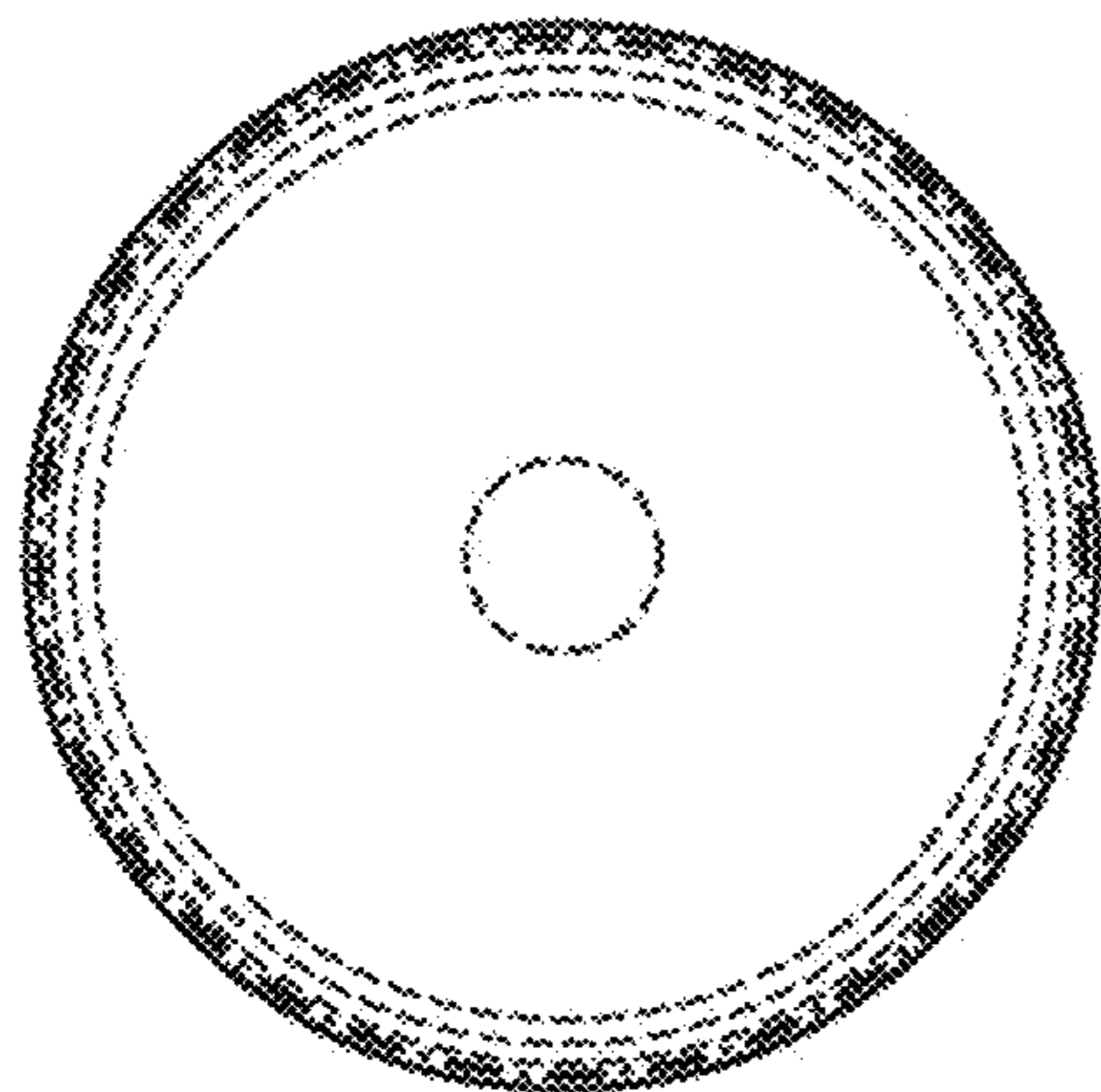

**FIG. 4**

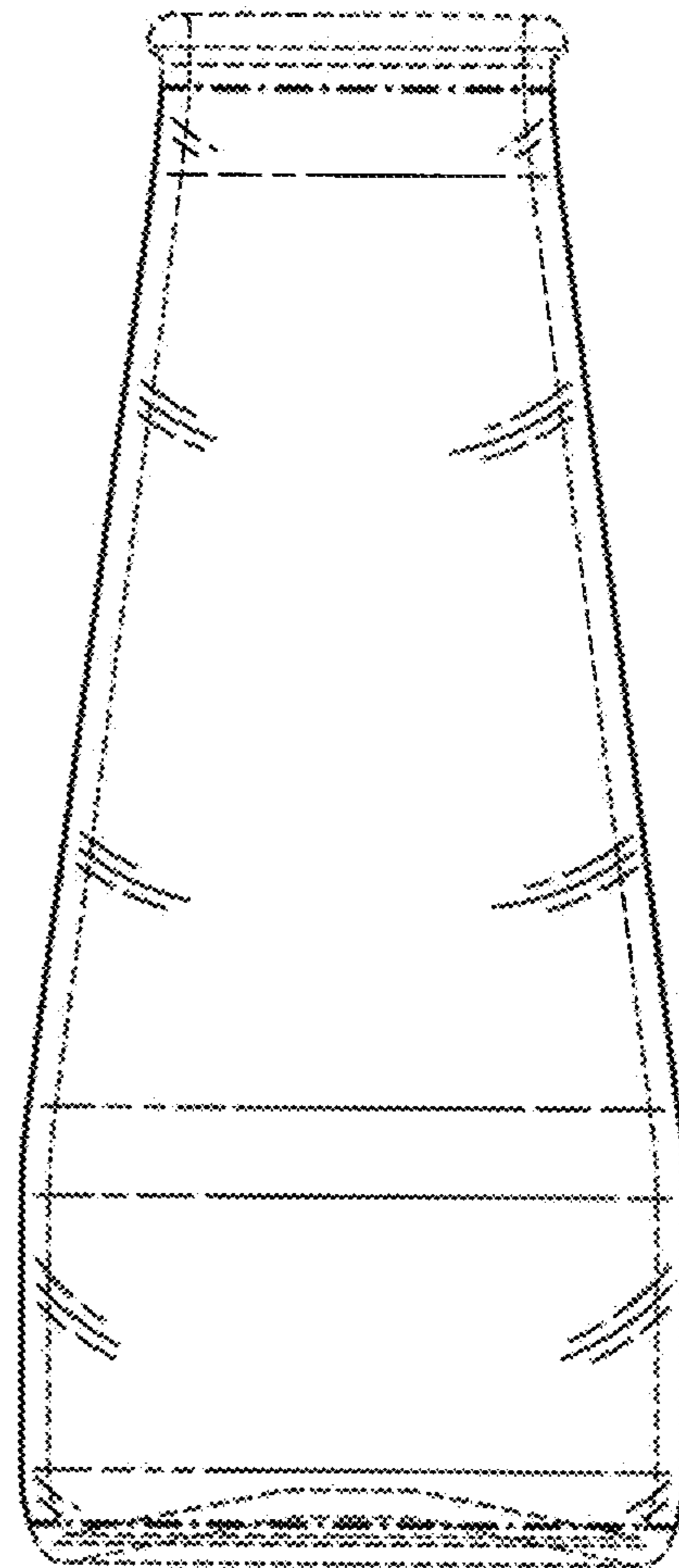

**FIG. 2**

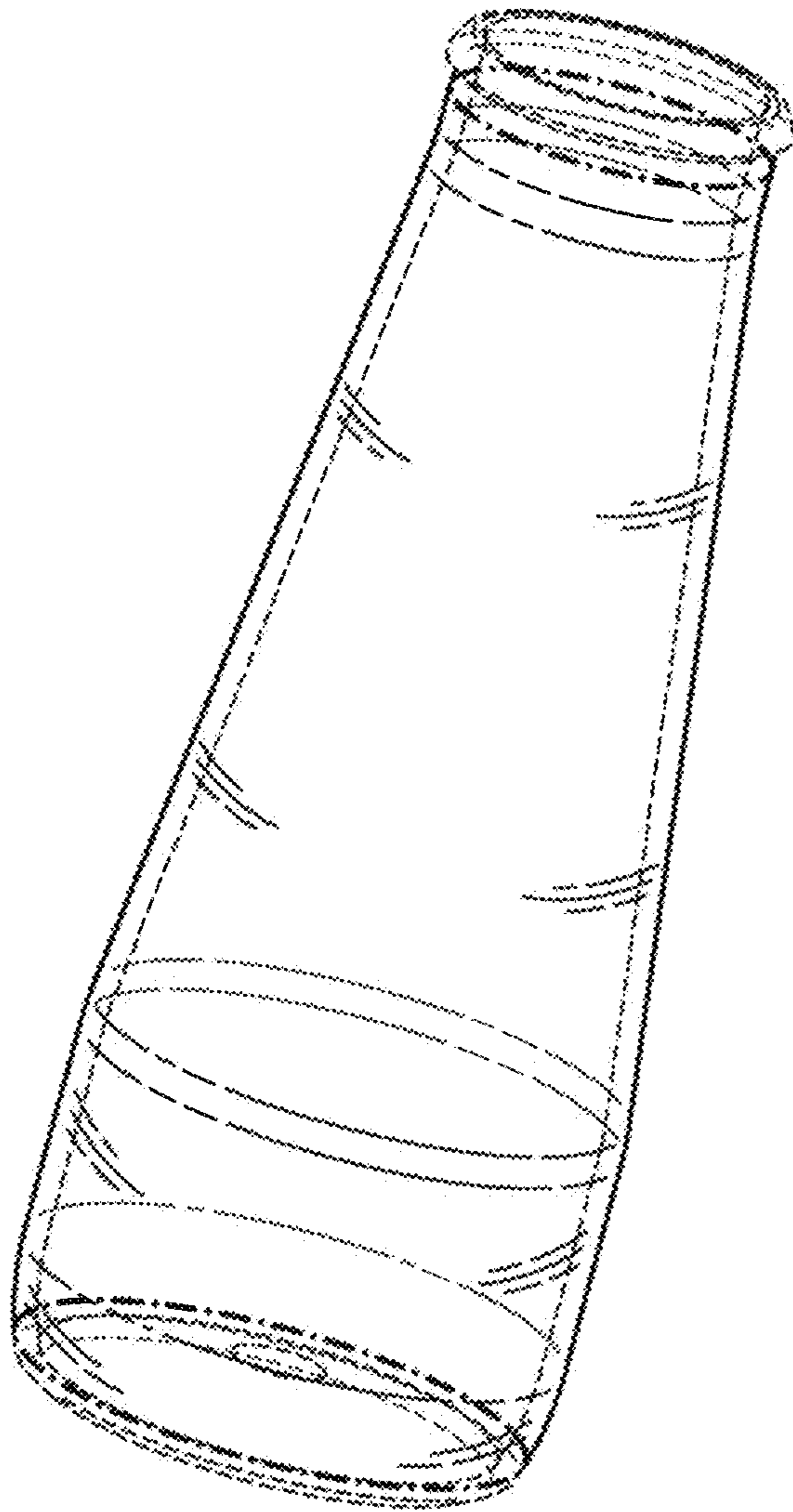

**FIG. 5**

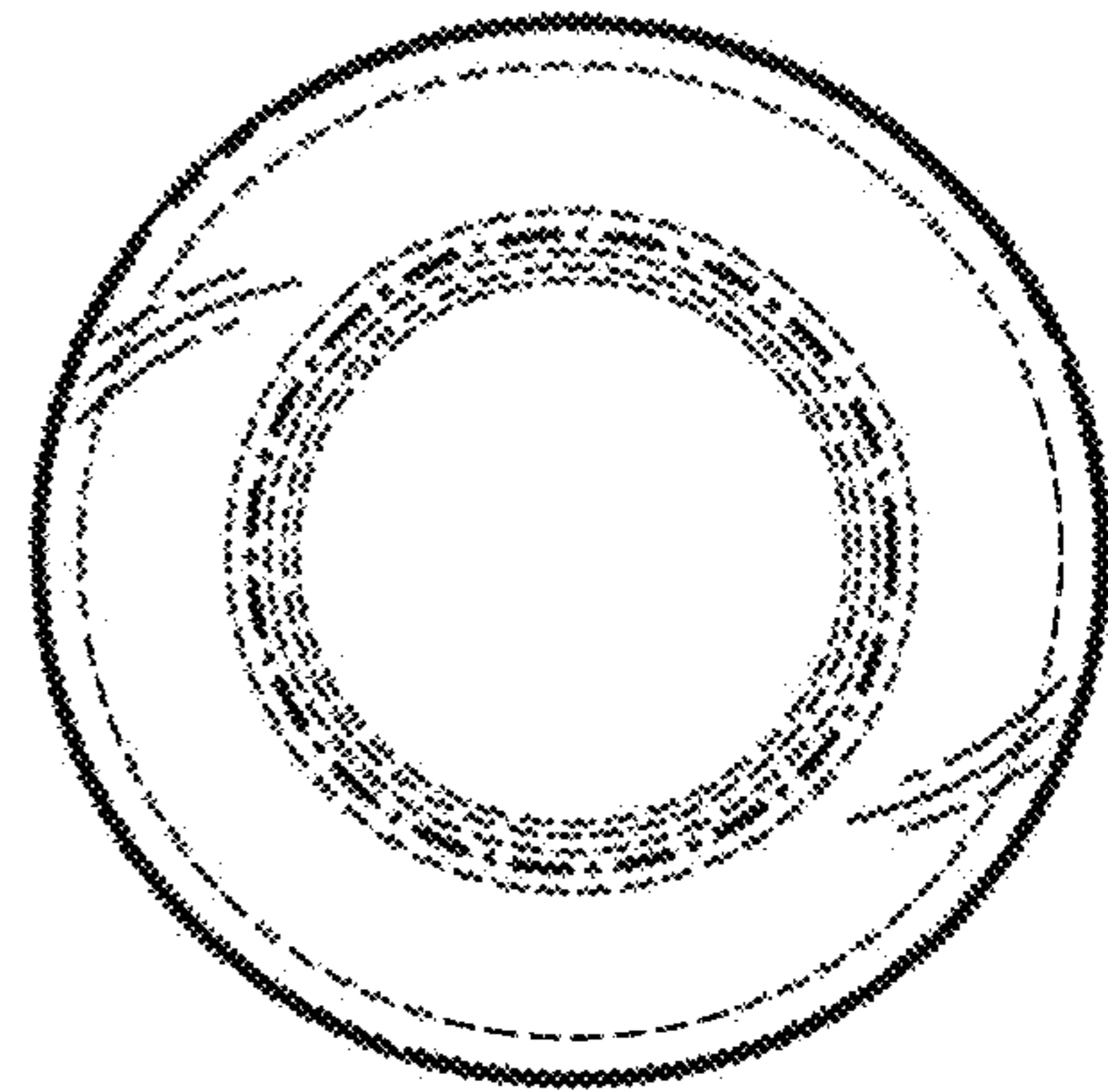

**FIG. 7**

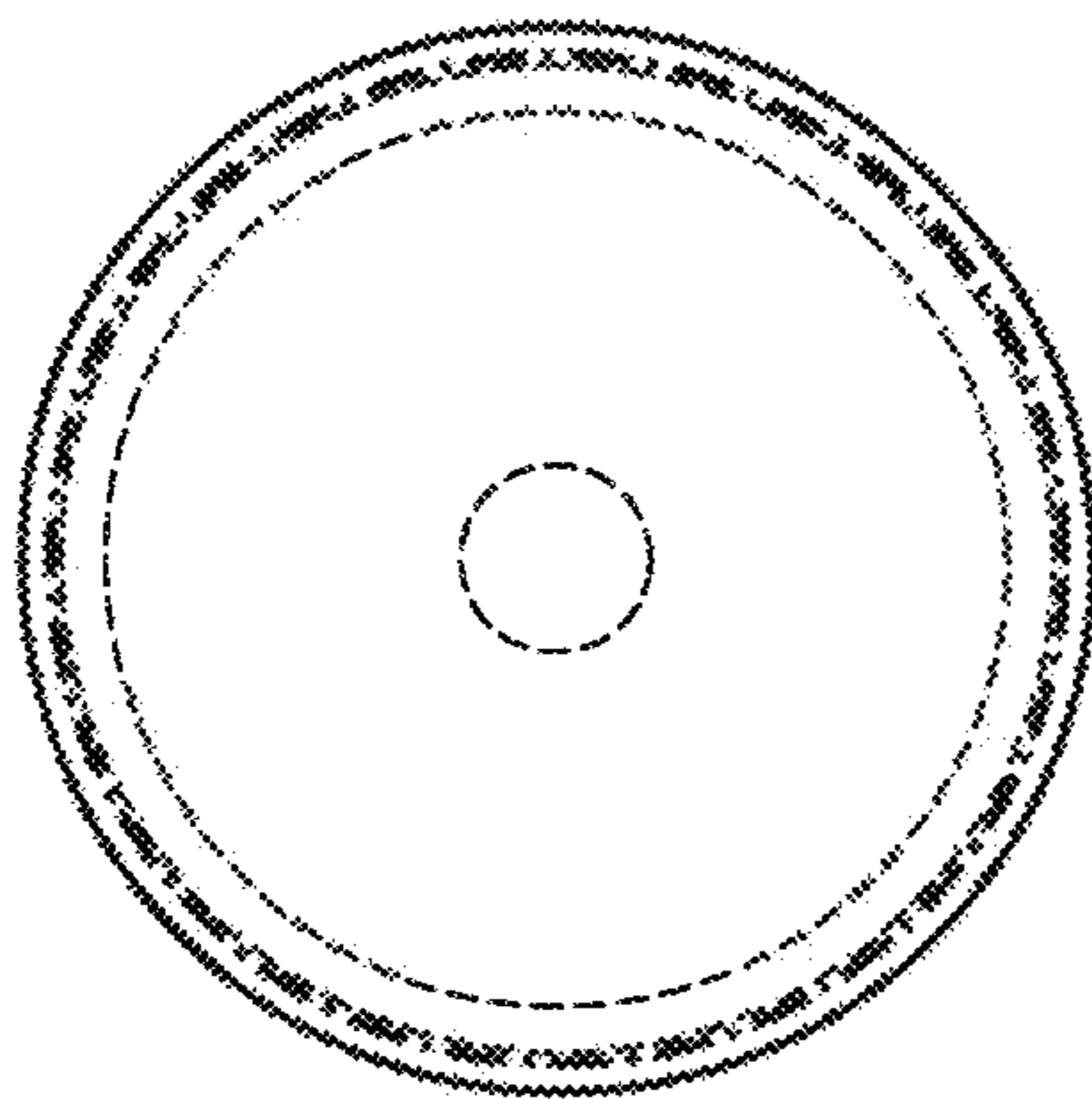

**FIG. 8**

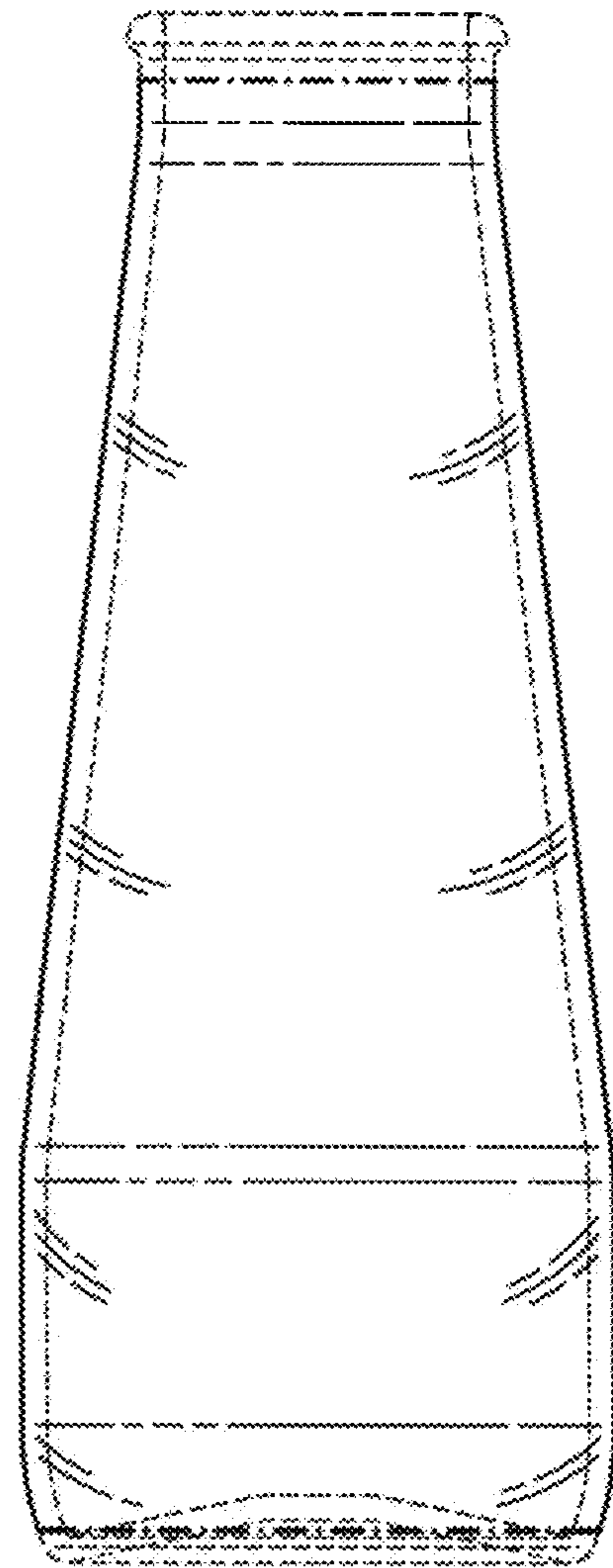

**FIG. 6**